



US00D385343S

United States Patent [19]
Chiu et al.

[11] **Patent Number: Des. 385,343**
[45] **Date of Patent: **Oct. 21, 1997**

[54] **HUMIDIFIER TANK**
[75] **Inventors: Bernard Chiu, Wellesley, Mass.;
Jui-Shang Wang, Taipei, Taiwan;
Stanley Gresens, Homewood, Ill.**
[73] **Assignee: Duracraft Corp., Southborough, Mass.**
[**] **Term: 14 Years**
[21] **Appl. No.: 46,024**
[22] **Filed: Nov. 6, 1995**

D. 357,310 4/1995 Chiu et al. D23/356
D. 358,461 5/1995 Barker et al. D23/356

Primary Examiner—Lisa Lichtenstein
Attorney, Agent, or Firm—John E. Toupal

[57] **CLAIM**

The ornamental design for a humidifier tank, as shown and described.

DESCRIPTION

FIG. 1 is a top front perspective view of a humidifier tank;
FIG. 2 is a bottom rear perspective view thereof;
FIG. 3 is a front elevational view thereof;
FIG. 4 is a rear elevational view thereof;
FIG. 5 is a top plan view thereof;
FIG. 6 is a bottom plan view thereof;
FIG. 7 is a right side elevational view thereof; and,
FIG. 8 is a left side elevational view thereof.
The broken line showing of environmental structure in
FIGS. 1–8 is for illustrative purposes only and forms no part
of the claimed design.

Related U.S. Application Data

[62] Division of Ser. No. 35,271, Feb. 23, 1995, Pat. No. Des.
370,059.
[51] **LOC (6) Cl.** **23-04**
[52] **U.S. Cl.** **D23/358; D23/356**
[58] **Field of Search** **D23/356–363;**
261/107, 104; 392/406, 405, 403, 395

[56] **References Cited**

U.S. PATENT DOCUMENTS

D. 298,351 11/1988 Ihlenfeld et al. D23/356

1 Claim, 6 Drawing Sheets

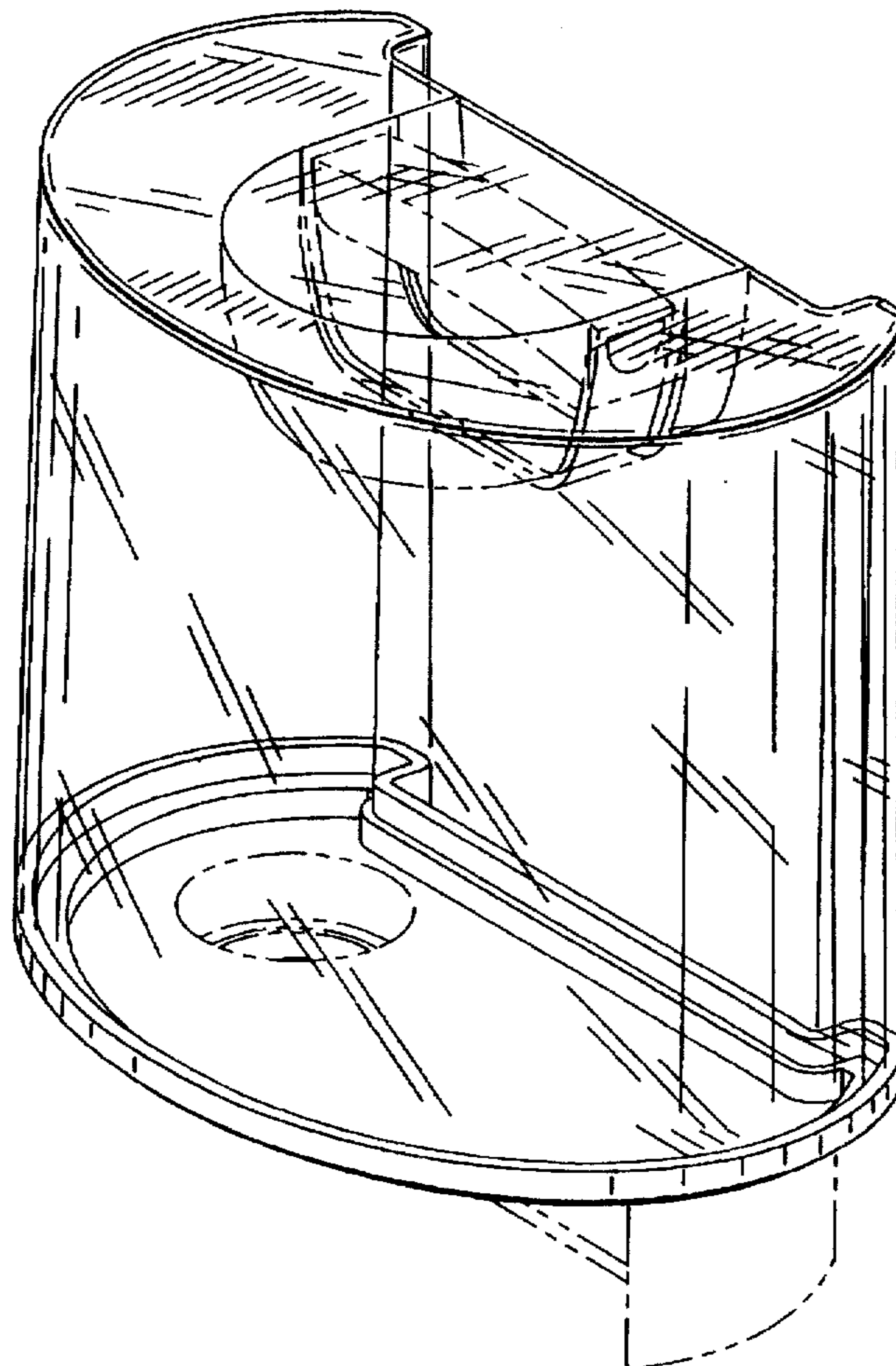

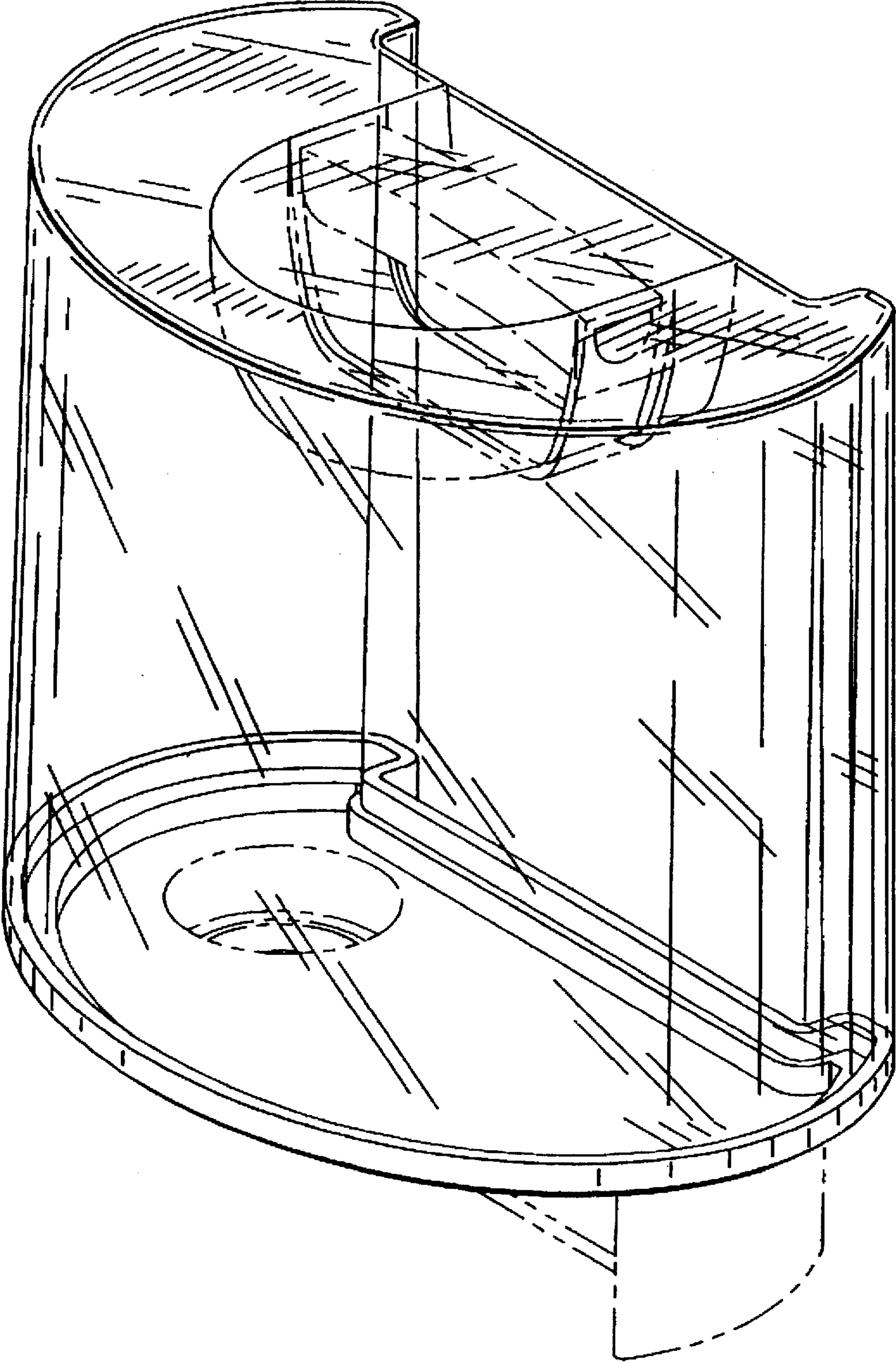

FIG. 1

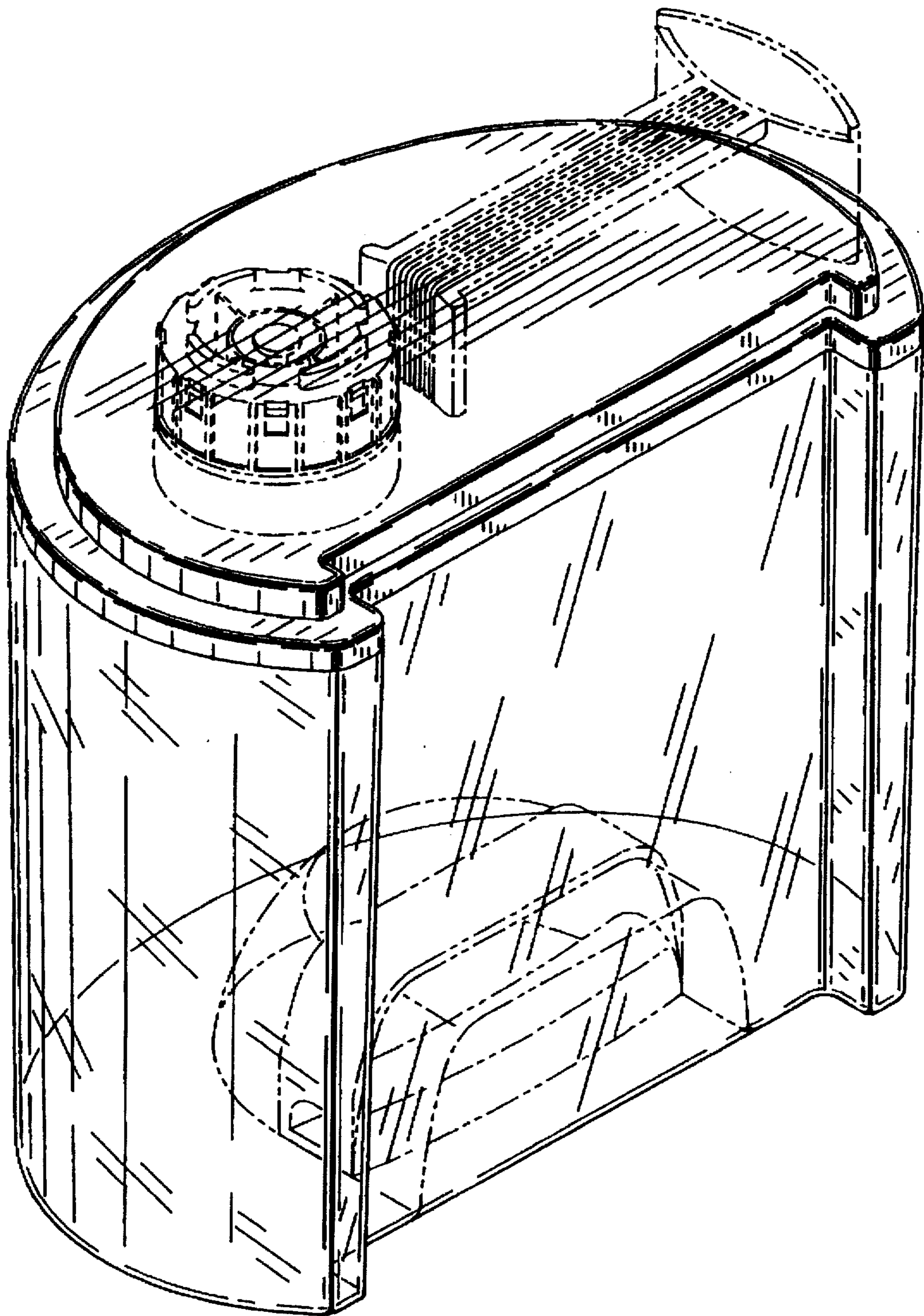

FIG. 2

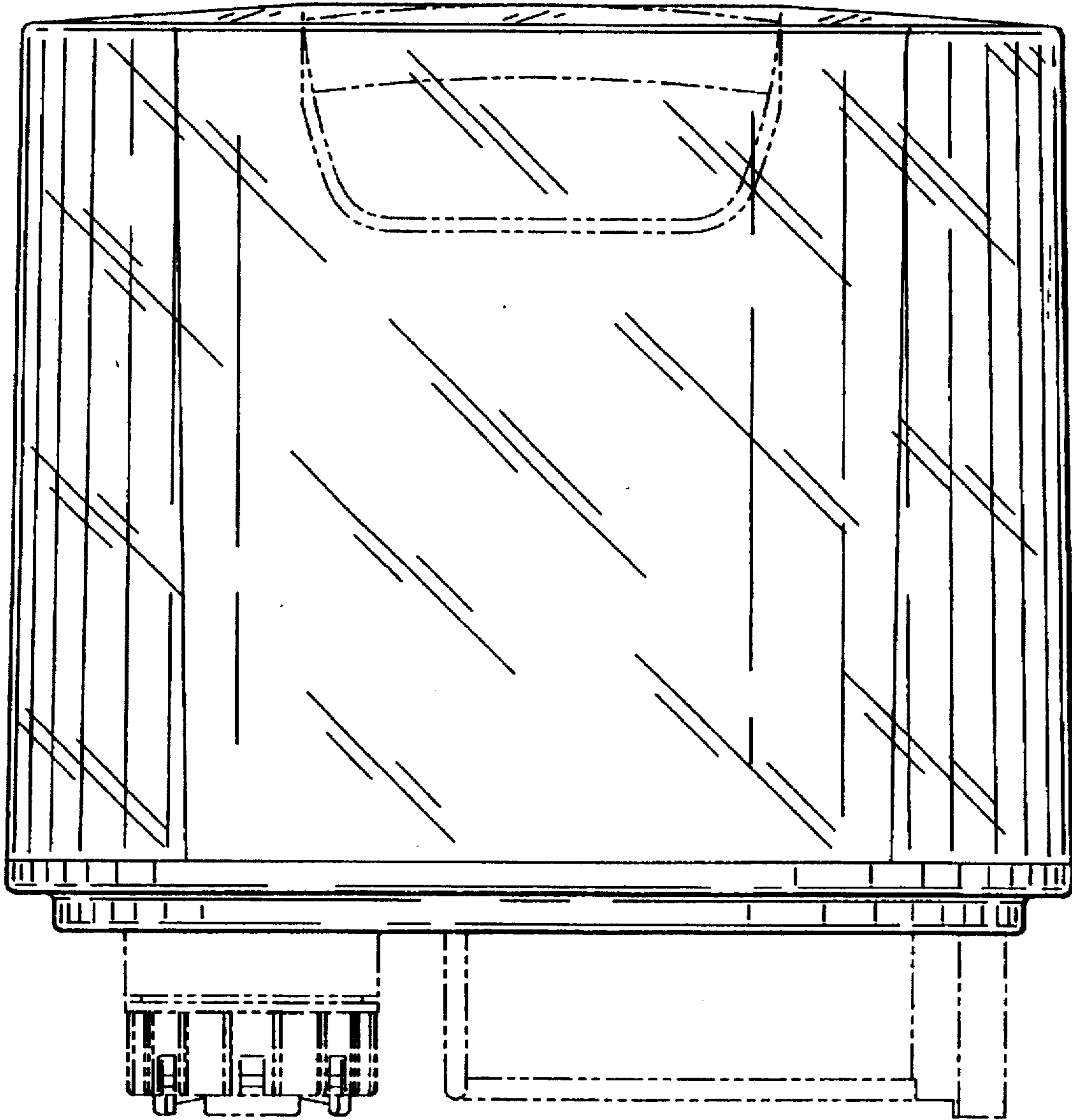

FIG. 3

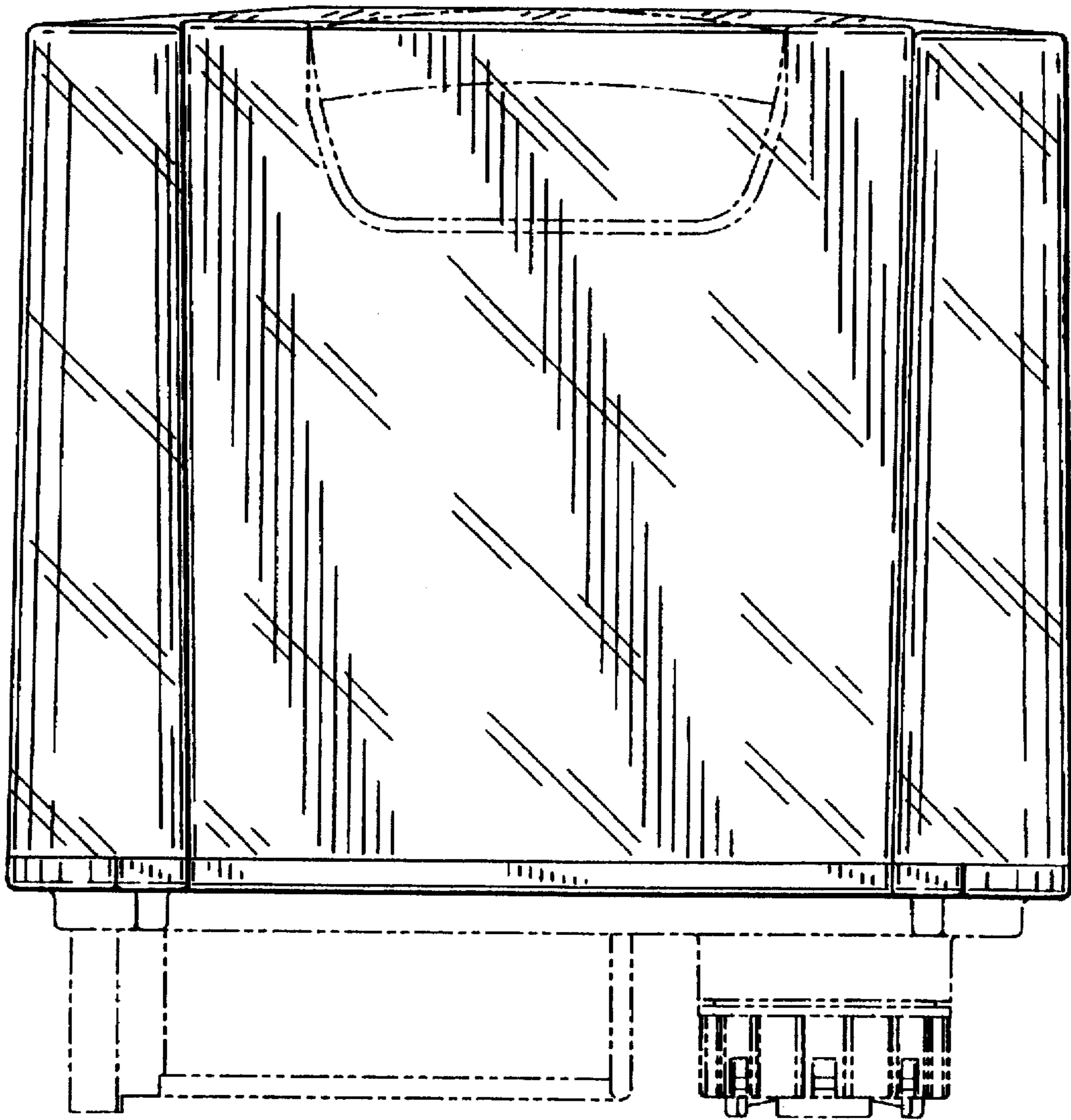

FIG. 4

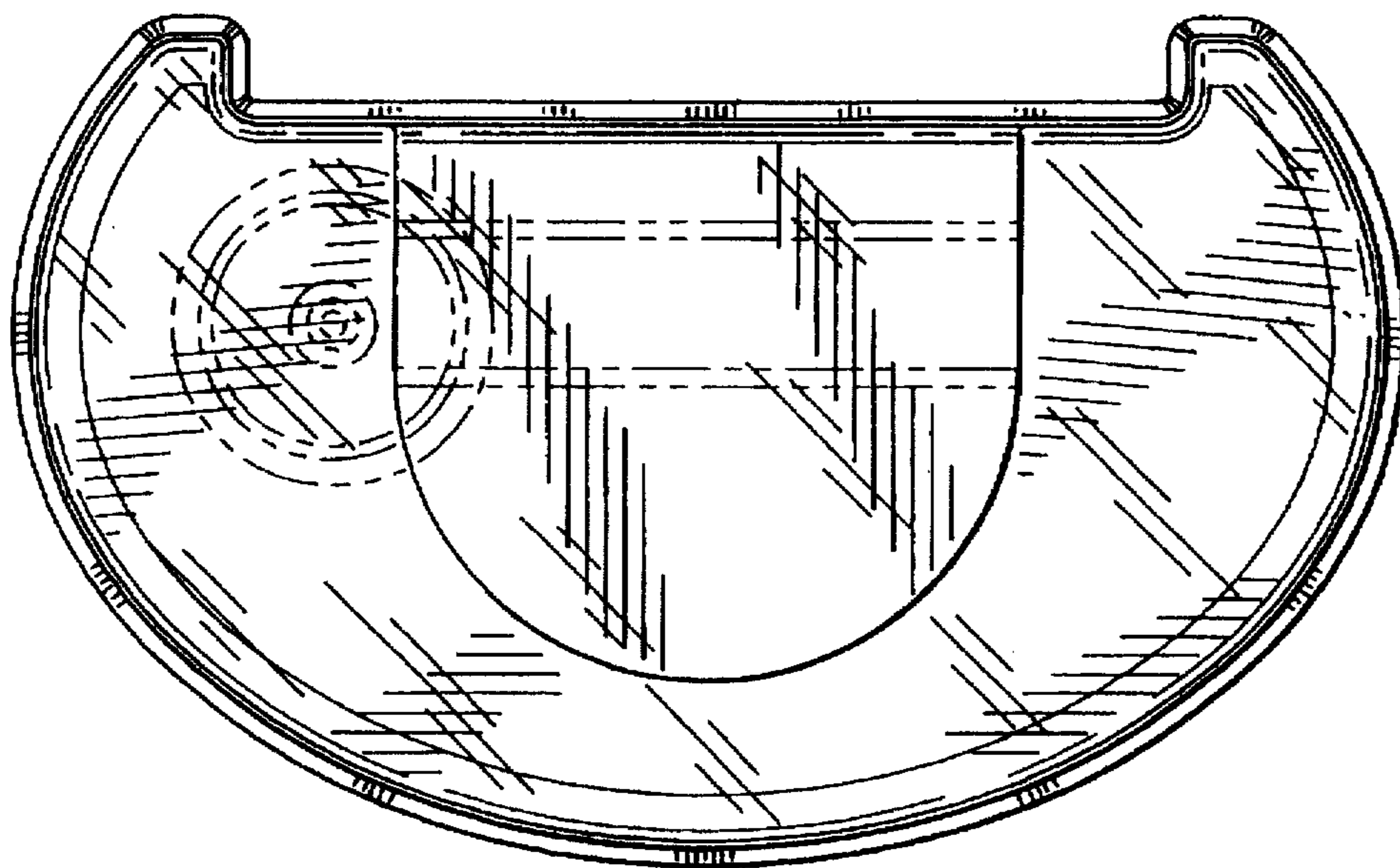

FIG. 5

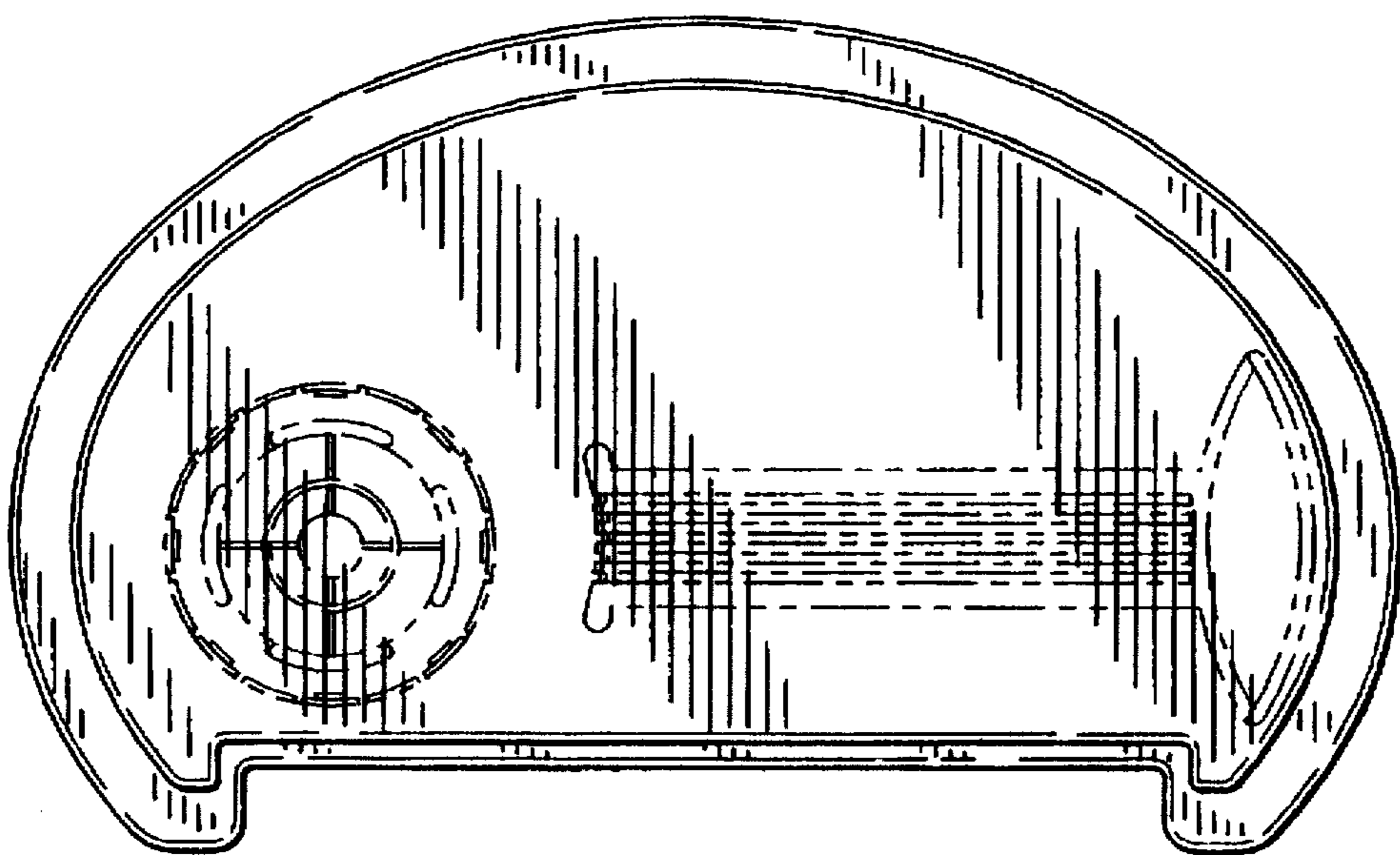

FIG. 6

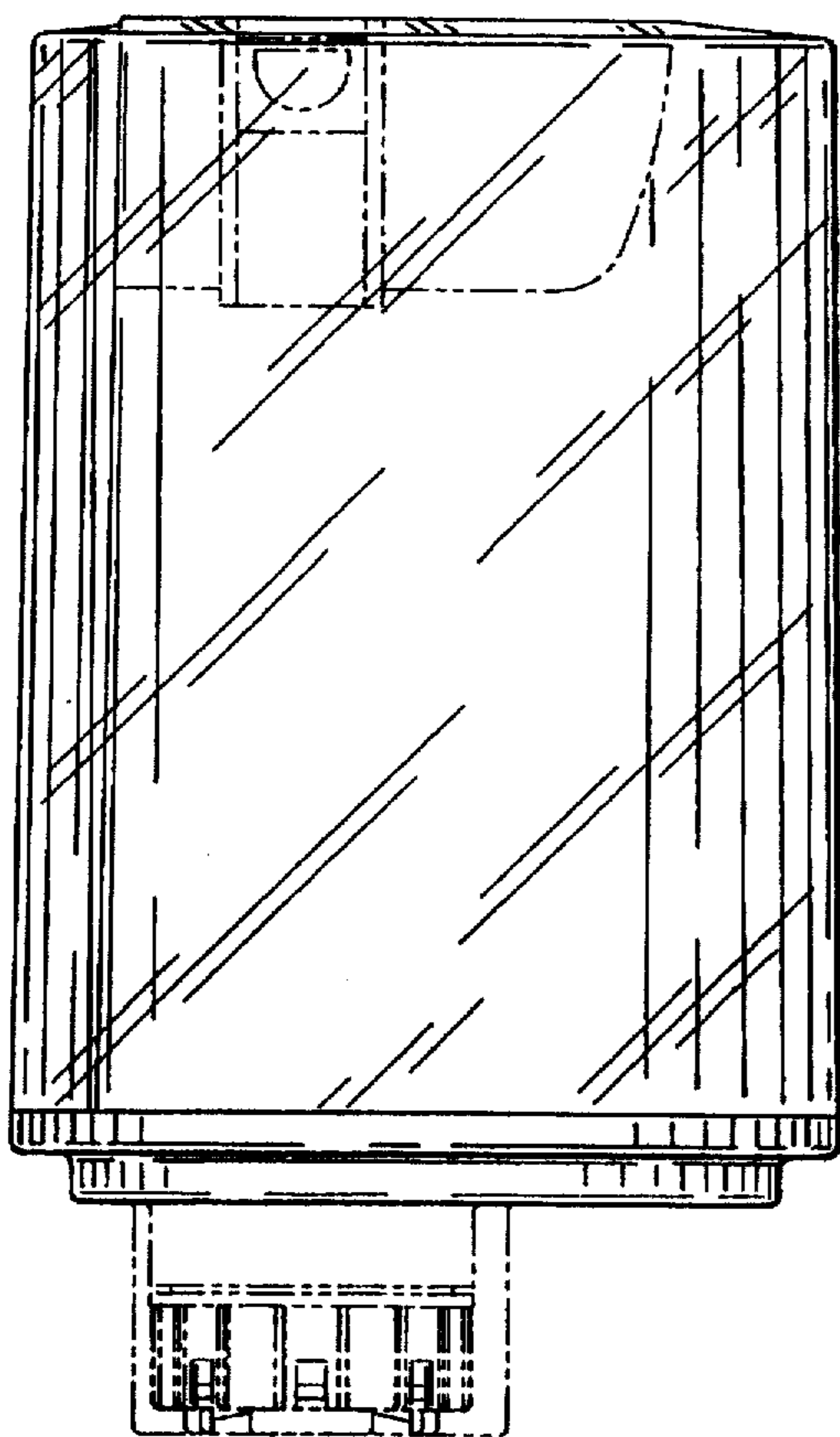

FIG. 7

FIG. 8

