



US00D385272S

United States Patent [19]
Jensen et al.

[11] **Patent Number: Des. 385,272**
[45] **Date of Patent: **Oct. 21, 1997**

- [54] **COMMUNICATION HEADSET**
- [75] **Inventors: Wolfgang W. Jensen, Aptos; David V. Hoenig, Los Gatos, both of Calif.**
- [73] **Assignee: ACS Wireless, Inc., Scotts Valley, Calif.**
- [**] **Term: 14 Years**
- [21] **Appl. No.: 56,068**
- [22] **Filed: Jun. 21, 1996**

5,210,792	5/1993	Kajihara	379/430
5,260,997	11/1993	Gathey et al.	379/430
5,450,496	9/1995	Burris et al.	381/183

OTHER PUBLICATIONS

U.S. Application No. 08/590,744, filed Jan. 24, 1996, entitled "Communications Headset," by Wolfgang W. Jensen and David V. Hoenig.
 Hello Direct Spring 1994, p. 9, Solo Pro At Top Right.
 BA Pargh 1992 Spring Summer Catalog, p. 333, Mirage Modular Headset, 2nd From Bottom Right.

Primary Examiner—Jeffrey Asch
Attorney, Agent, or Firm—Limbach & Limbach L.L.P.

Related U.S. Application Data

- [63] Continuation-in-part of Ser. No. 590,744, Jan. 24, 1996.
- [51] **LOC (6) Cl. 14-03**
- [52] **U.S. Cl. D14/142**
- [58] **Field of Search D14/192, 223, D14/206, 140, 142, 249, 205, 148, 147, 240; 379/419, 420, 428, 440, 430, 433; 455/89, 90; 381/183**

[57] **CLAIM**

The ornamental design for a communication headset, as shown and described.

DESCRIPTION

FIG. 1 is a perspective view of a communications headset showing our design;
 FIG. 2 is a side elevational view thereof;
 FIG. 3 is a top plan view thereof;
 FIG. 4 is a bottom plan view thereof;
 FIG. 5 is a front elevational view thereof;
 FIG. 6 is a rear elevational view thereof; and,
 FIG. 7 is an opposite side elevational view thereof.
 The perspective view of FIG. 1 is an alternative position for use. The broken line showings of FIG. 1, 2, 5, 6, and 7 are for illustrative purposes only and form no part of the claimed design.

[56] **References Cited**

U.S. PATENT DOCUMENTS

- | | | | |
|------------|---------|-----------------------|-----------|
| D. 233,444 | 10/1974 | Christian et al. | D14/206 |
| D. 326,653 | 6/1992 | Hino | D14/192 |
| D. 339,355 | 9/1993 | Burris et al. | D14/206 X |
| D. 366,486 | 1/1996 | Runquist et al. | D14/206 |
| D. 371,133 | 6/1996 | Andrea | D14/206 |
| 4,020,297 | 4/1977 | Brodie | 379/430 |
| 4,273,969 | 6/1981 | Foley et al. | 379/430 |
| 4,893,344 | 1/1990 | Traardh et al. | 379/430 X |

1 Claim, 4 Drawing Sheets

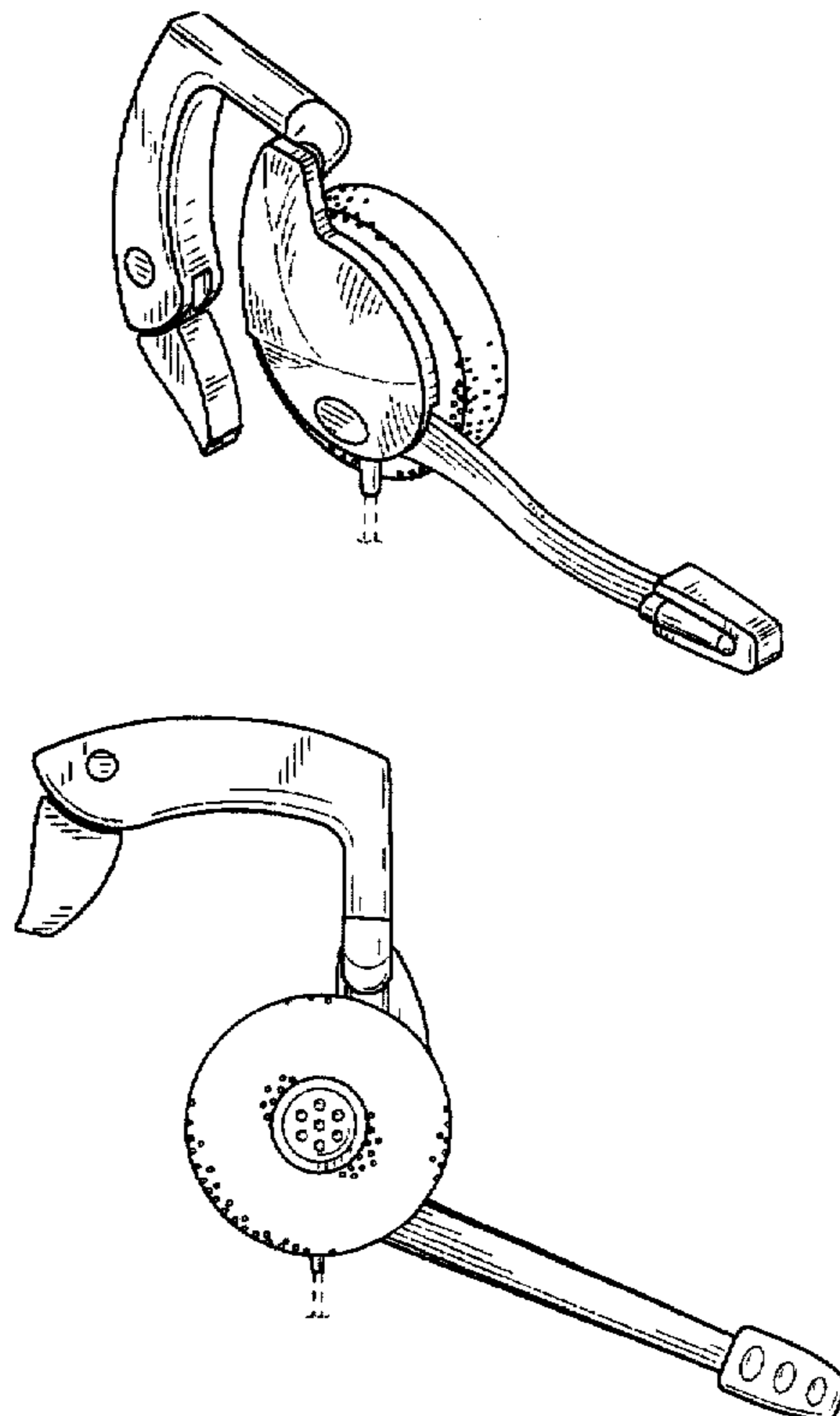

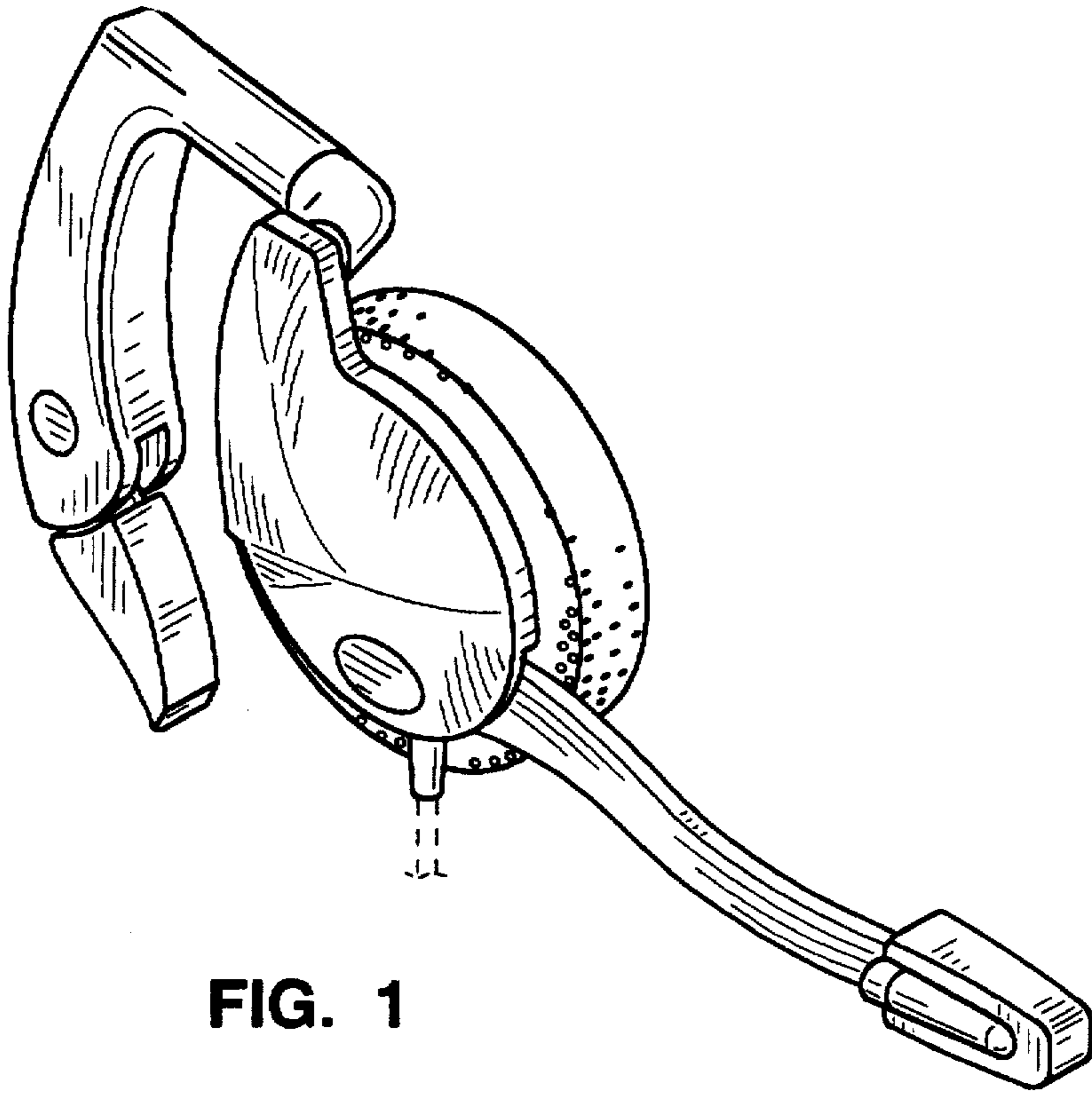

FIG. 1

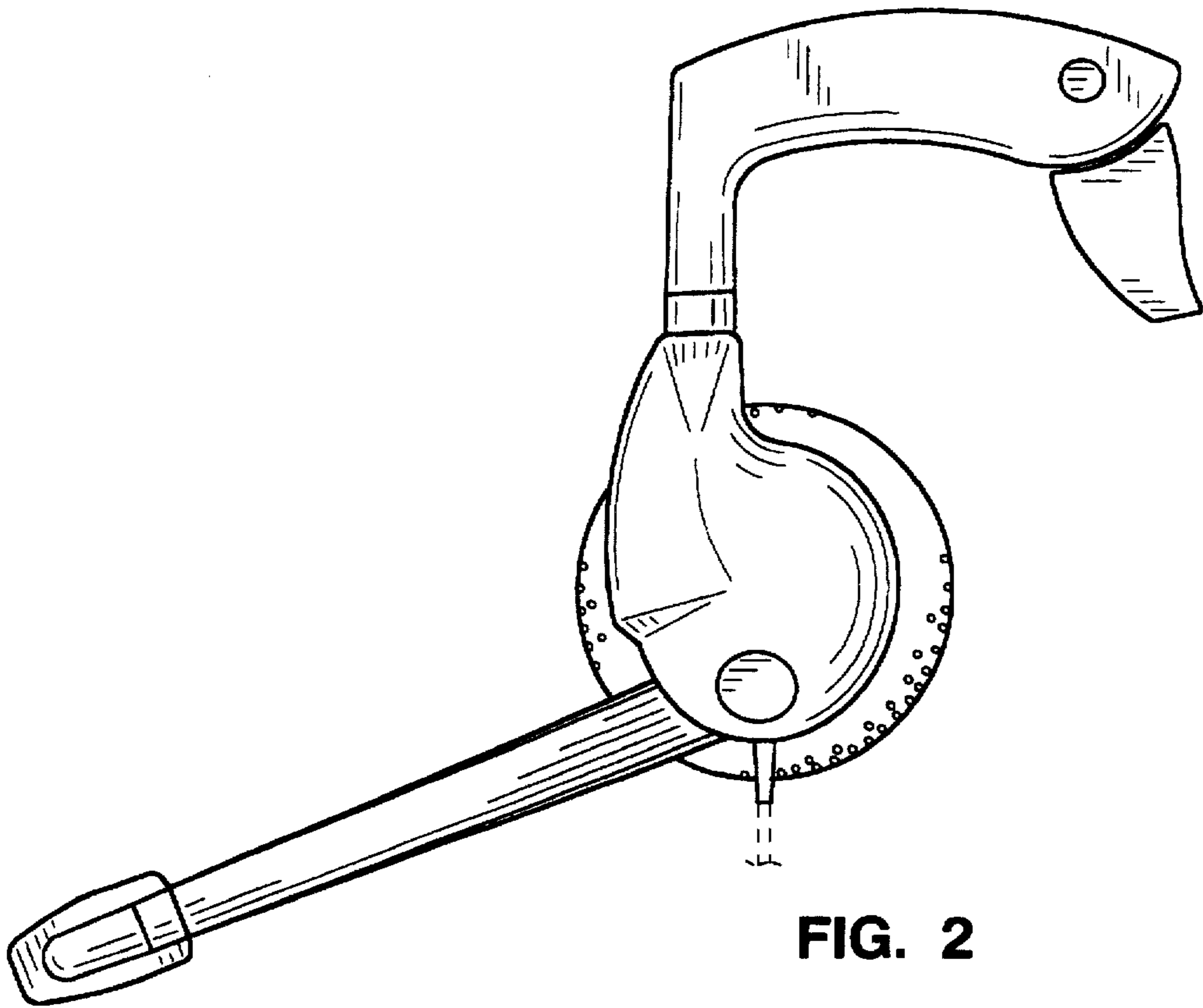

FIG. 2

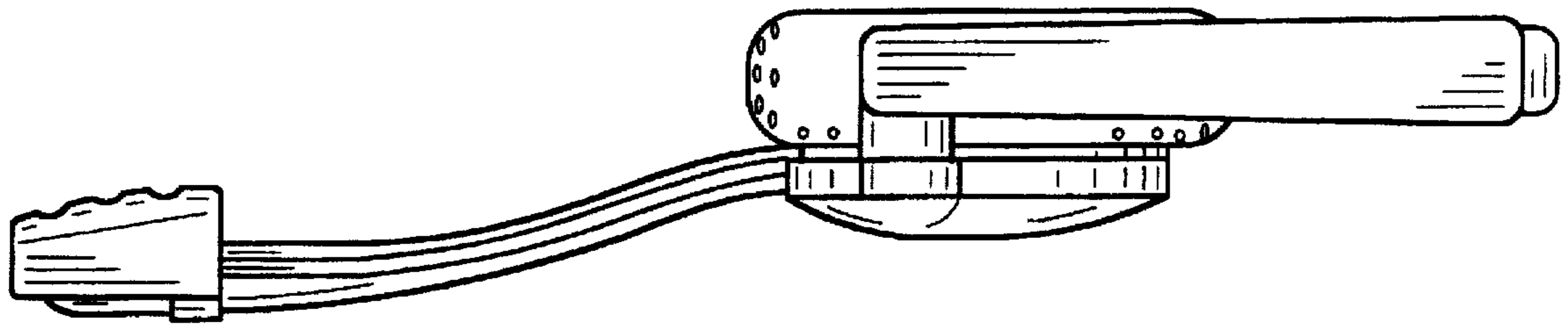

FIG. 3

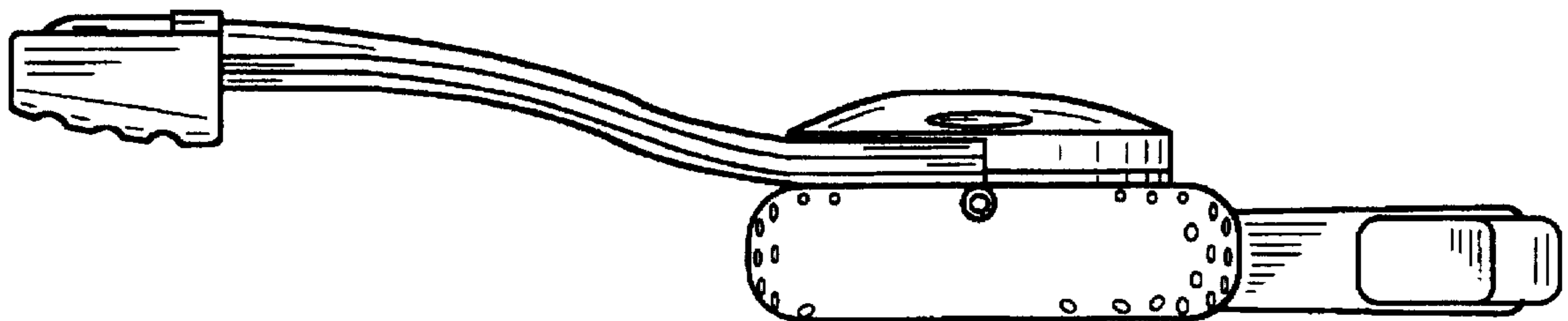

FIG. 4

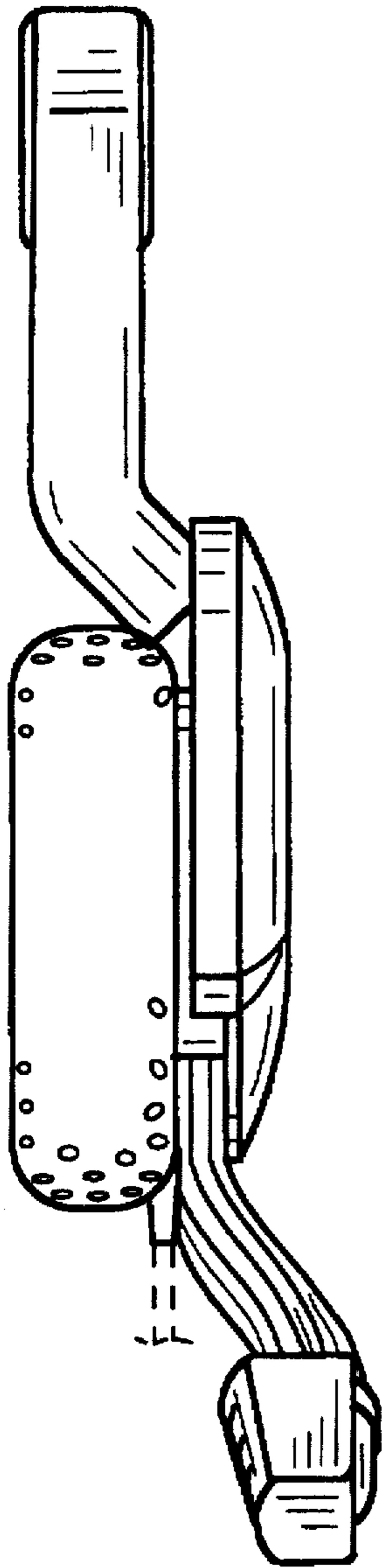

FIG. 5

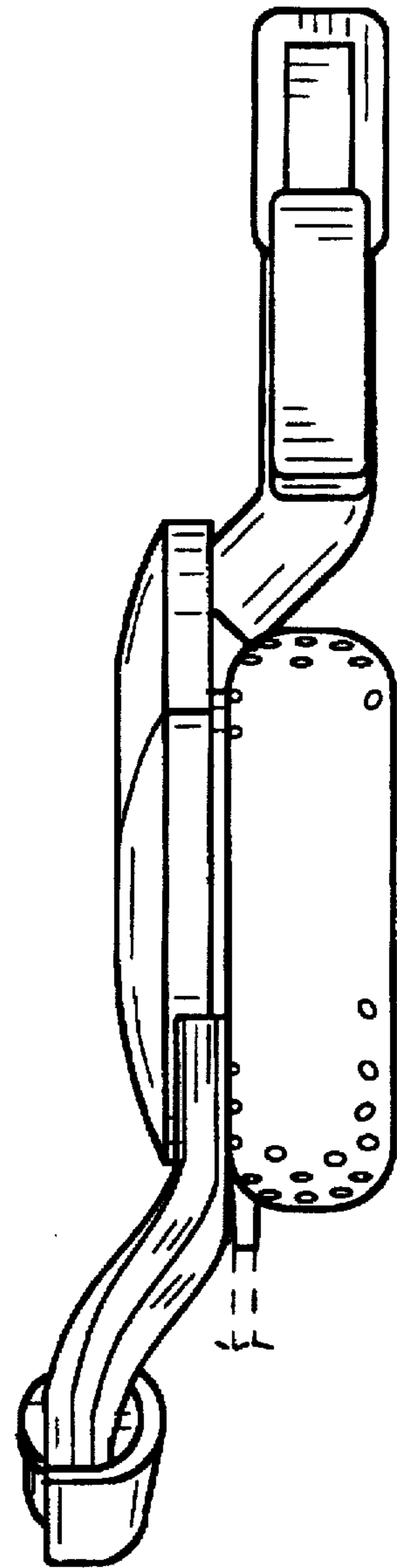

FIG. 6

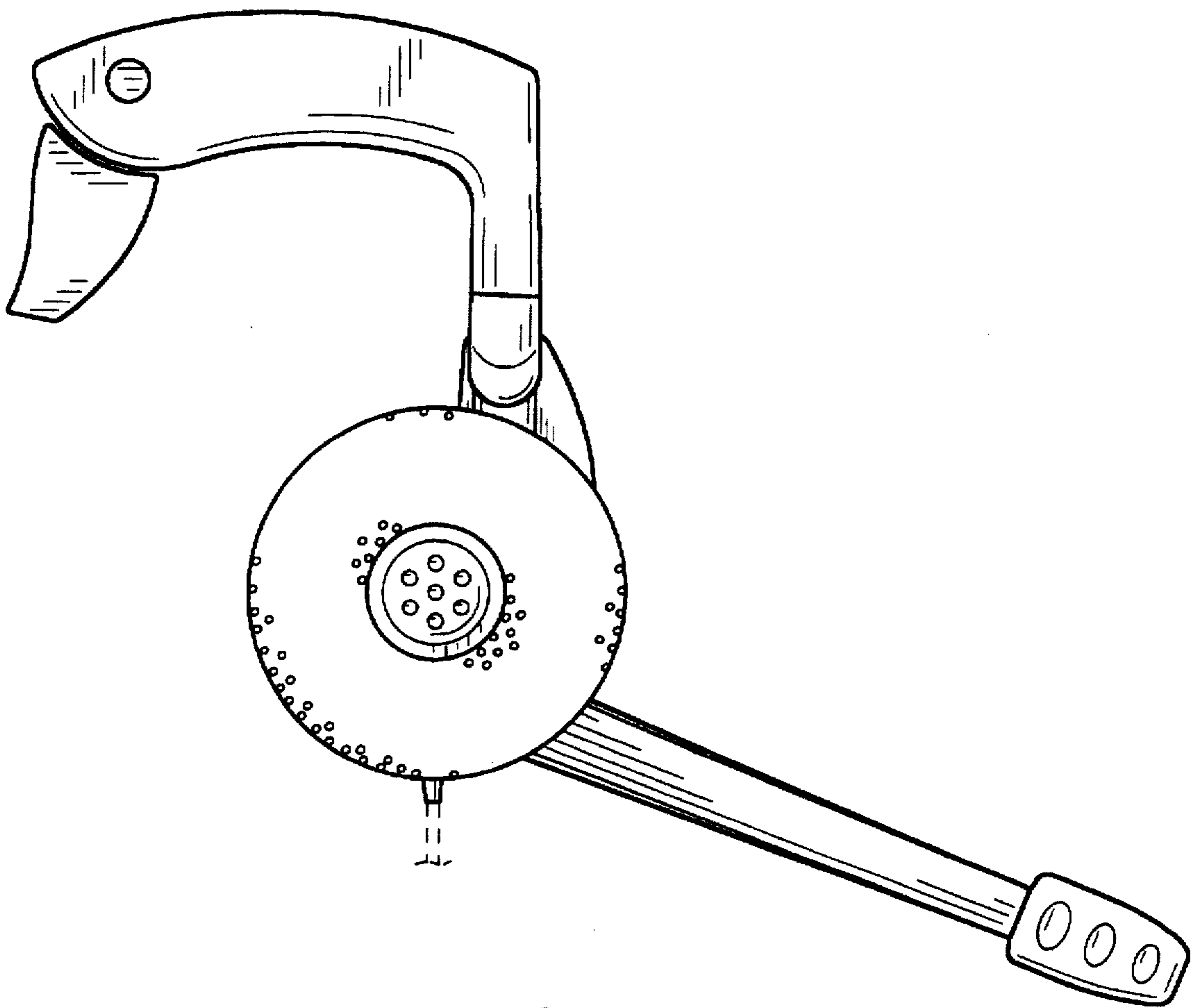

FIG. 7