

US00D385194S

United States Patent [19]
Robbins, III

[11] **Patent Number: Des. 385,194**
[45] **Date of Patent: **Oct. 21, 1997**

[54] **SIDE WALLS FOR A CONTAINER**
[76] **Inventor: Edward S. Robbins, III, 2802 E. Avalon Ave., Muscle Shoals, Ala. 35661**
[**] **Term: 14 Years**
[21] **Appl. No.: 27,150**
[22] **Filed: Jul. 12, 1994**
[51] **LOC (6) Cl. 09-01**
[52] **U.S. Cl. D9/502; D9/562**
[58] **Field of Search D9/500, 502, 503, D9/504, 505, 562, 557, 554, 537, 538, 539, 540, 541, 428, 548; 215/382, 383, 384, 400; 220/8**

[56] **References Cited**

U.S. PATENT DOCUMENTS

D. 39,840	2/1909	Annis	D9/502
D. 105,880	8/1937	Kohl	D9/502
D. 213,173	1/1969	Lockhart	D9/557 X
D. 257,715	12/1980	Pettengill	D9/529
D. 358,764	5/1995	Robbins, III	D9/428
D. 364,088	11/1995	Robbins, III	D9/428
625,719	5/1899	Crofford .	
640,418	1/1900	Royer .	
1,032,731	7/1912	Barnett	220/8
1,040,652	10/1912	Douglas .	
1,048,935	12/1912	Brady .	
2,784,882	3/1957	Du Bois .	
2,880,902	4/1959	Owsen .	

(List continued on next page.)

FOREIGN PATENT DOCUMENTS

587701	4/1925	France .
1301970	8/1969	Germany .
2340967	3/1974	Germany .
3937456	5/1991	Germany .
4-102544	4/1992	Japan .
2109247	6/1983	United Kingdom .
2138525	10/1984	United Kingdom .
WO88/05014	7/1988	WIPO .

Primary Examiner—Lucy Lieberman
Attorney, Agent, or Firm—Nixon & Vanderhye P.C.

[57] **CLAIM**
The ornamental design for a side walls for a container, as shown and described.

DESCRIPTION

FIG. 1 is a side elevation illustrating a side wall profile design for a container in accordance with a first embodiment of my new design;
FIG. 2 is a top plan view thereof;
FIG. 3 is a bottom plan view thereof;
FIG. 4 is a side elevation illustrating a side wall profile design for a container in accordance with a second exemplary embodiment of my design;
FIG. 5 is a top plan view thereof;
FIG. 6 is a bottom plan view thereof;
FIG. 7 is a side elevation illustrating a side wall profile design for a container in accordance with a third exemplary embodiment of the invention;
FIG. 8 is a top plan view thereof;
FIG. 9 is a bottom plan view thereof;
FIG. 10 is a side elevation illustrating a side wall profile design for a container in accordance with a fourth exemplary embodiment of the invention;
FIG. 11 is a top plan view thereof;
FIG. 12 is a bottom plan view thereof;
FIG. 13 is a side elevation illustrating a side wall profile design for a container in accordance with a fifth exemplary embodiment of the invention;
FIG. 14 is a top plan view thereof;
FIG. 15 is a bottom plan view thereof;
FIG. 16 is a side elevation illustrating a side wall profile design for a container in accordance with a sixth exemplary embodiment of the invention;
FIG. 17 is a top plan view thereof;
FIG. 18 is a bottom plan view thereof;
FIG. 19 is a side elevation illustrating a side wall profile design for a container, partially textured, in accordance with a seventh exemplary embodiment of the invention;
FIG. 20 is a top plan view thereof; and,
FIG. 21 is a bottom plan view thereof.
The dotted line top and bottom configurations are intended to illustrate environment only, and do not form any part of the claimed subject matter.
The front and rear elevations of each embodiment are the same in appearance as the side elevations.

1 Claim, 14 Drawing Sheets

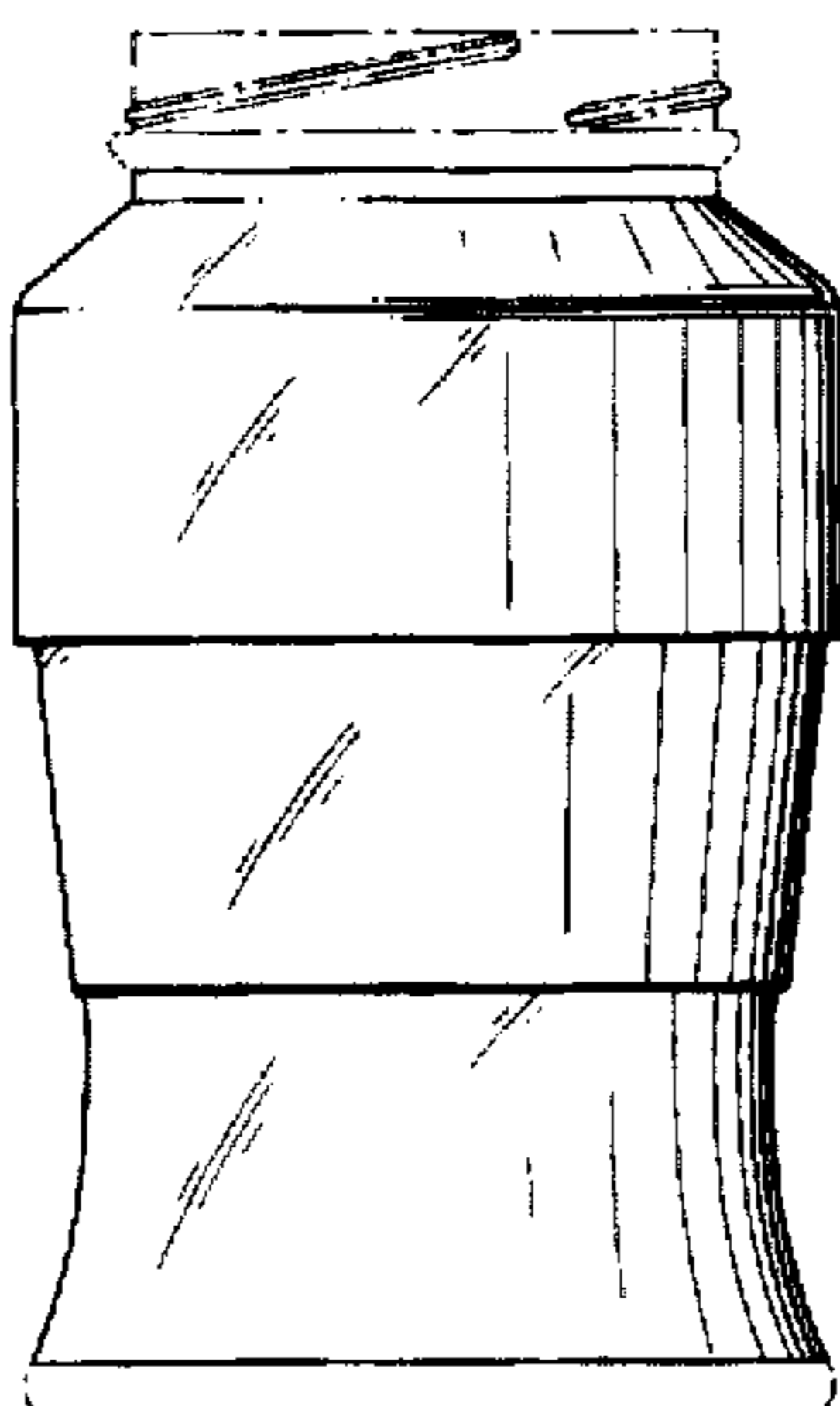

U.S. PATENT DOCUMENTS

2,893,167	7/1959	Davidson .	4,428,507	1/1984	Sneider .	
2,899,110	8/1959	Parker .	4,456,134	6/1984	Cooper .	
2,985,915	5/1961	Winstead .	4,492,313	1/1985	Touzani .	
3,143,429	8/1964	Swanson et al. .	4,706,829	11/1987	Li .	
3,156,383	11/1964	Melli .	4,712,699	12/1987	Lutz .	
3,220,544	11/1965	Lovell .	4,775,564	10/1988	Shriver et al. .	
3,286,872	11/1966	Burdick, Jr. .	4,805,799	2/1989	Robbins, III .	
3,291,361	12/1966	Commeyras D9/500 X	4,815,615	3/1989	Phlaphongphanich .	
3,301,293	1/1967	Santelli .	4,844,273	7/1989	Hawkins .	
3,326,421	6/1967	Peace .	4,846,376	7/1989	Palmer .	
3,329,298	7/1967	Demas .	4,865,211	9/1989	Hollingsworth .	
3,467,283	9/1969	Kinnavy .	4,873,100	10/1989	Dirksing et al. .	
3,494,509	2/1970	McGuire .	4,875,576	10/1989	Torgrimson et al. .	
3,578,415	5/1971	Hiltz .	4,892,126	1/1990	Bucheler et al. .	
3,608,268	9/1971	Lauritzen .	4,925,055	5/1990	Robbins, III et al. .	
3,690,522	9/1972	Chlystun .	4,930,644	6/1990	Robbins, III .	
3,707,241	12/1972	Taylor .	4,955,493	9/1990	Touzani .	
3,864,771	2/1975	Bauer et al. .	4,979,628	12/1990	Robbins, III .	
3,875,941	4/1975	Adair .	5,002,193	3/1991	Touzani .	
3,939,888	2/1976	Scarnato .	5,226,551	7/1993	Robbins, III 215/383 X	
4,087,024	5/1978	Martin et al. .	5,392,941	2/1995	Robbins, III 220/8	
4,219,137	8/1980	Hutchens .	5,417,337	5/1995	Robbins, III 215/400 X	

FIG. 1

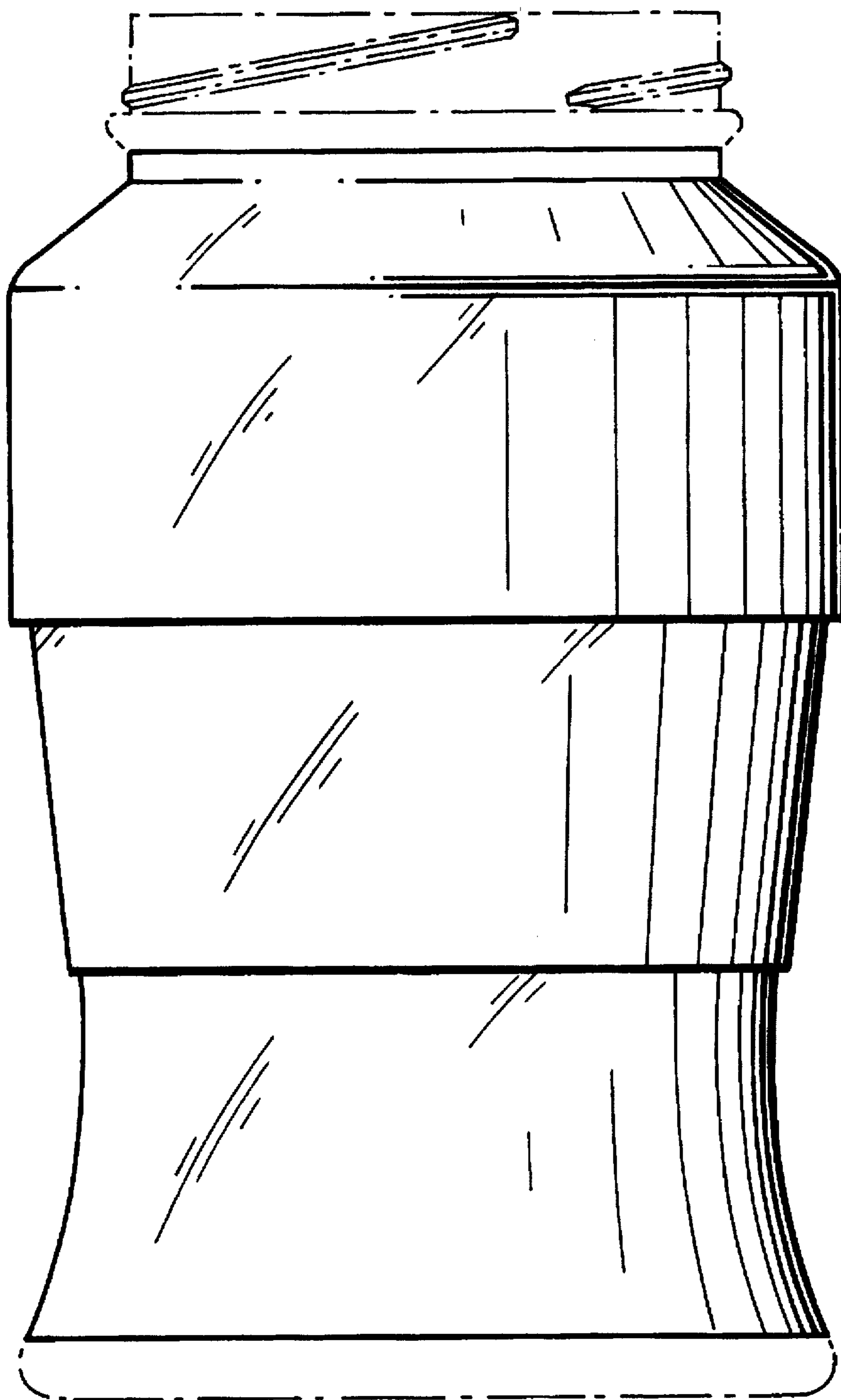

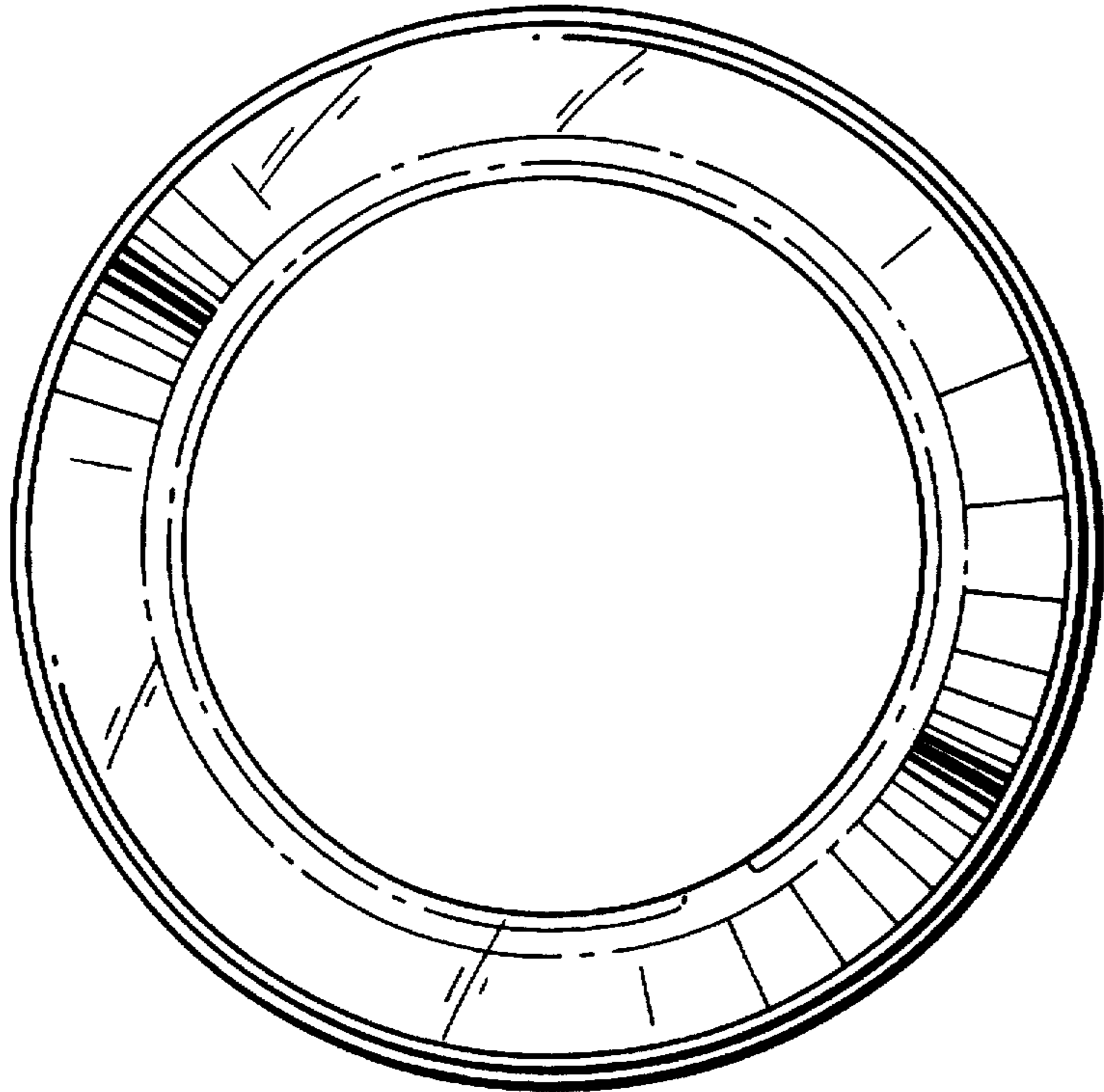

FIG. 2

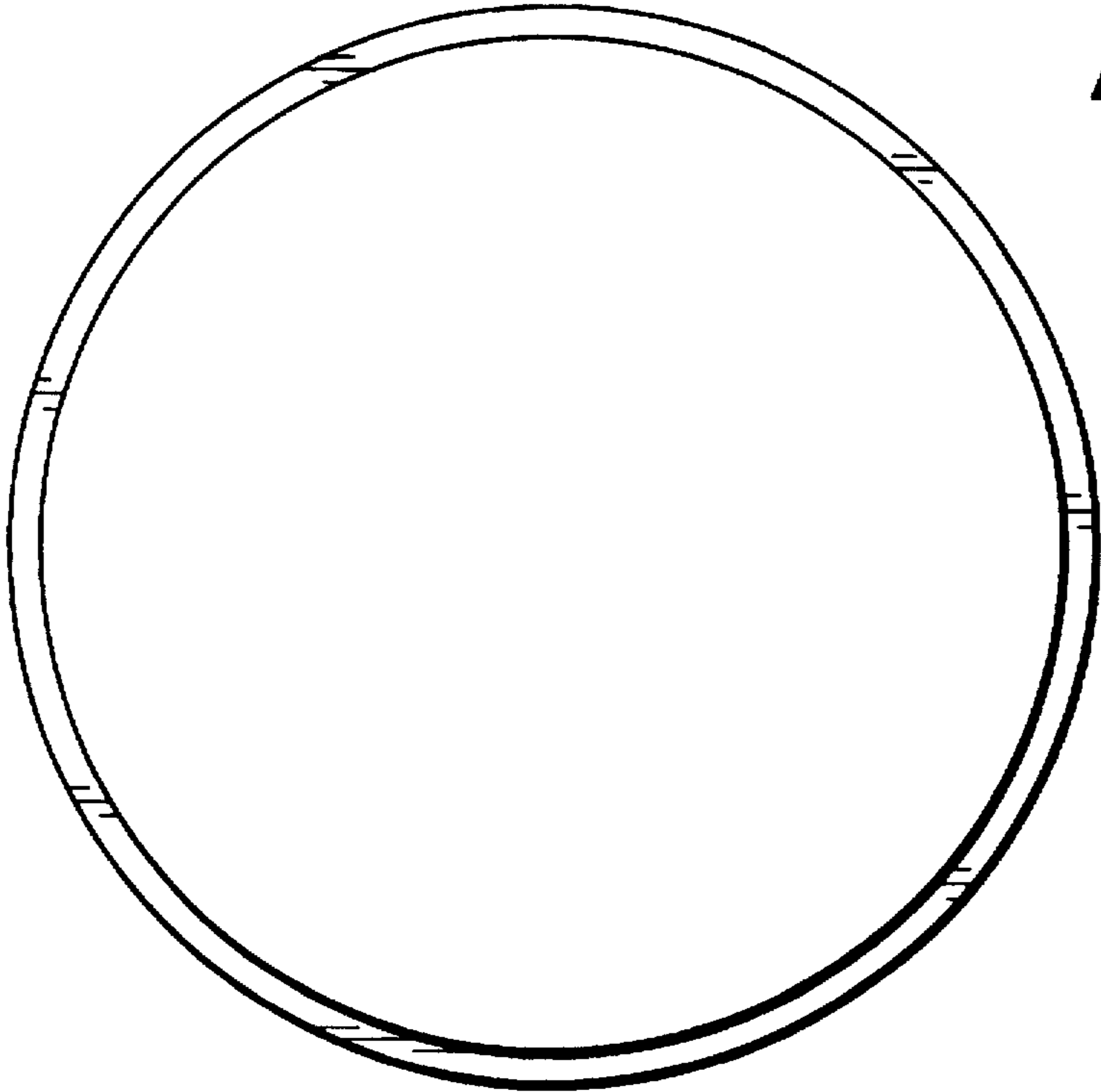

FIG. 3

FIG. 4

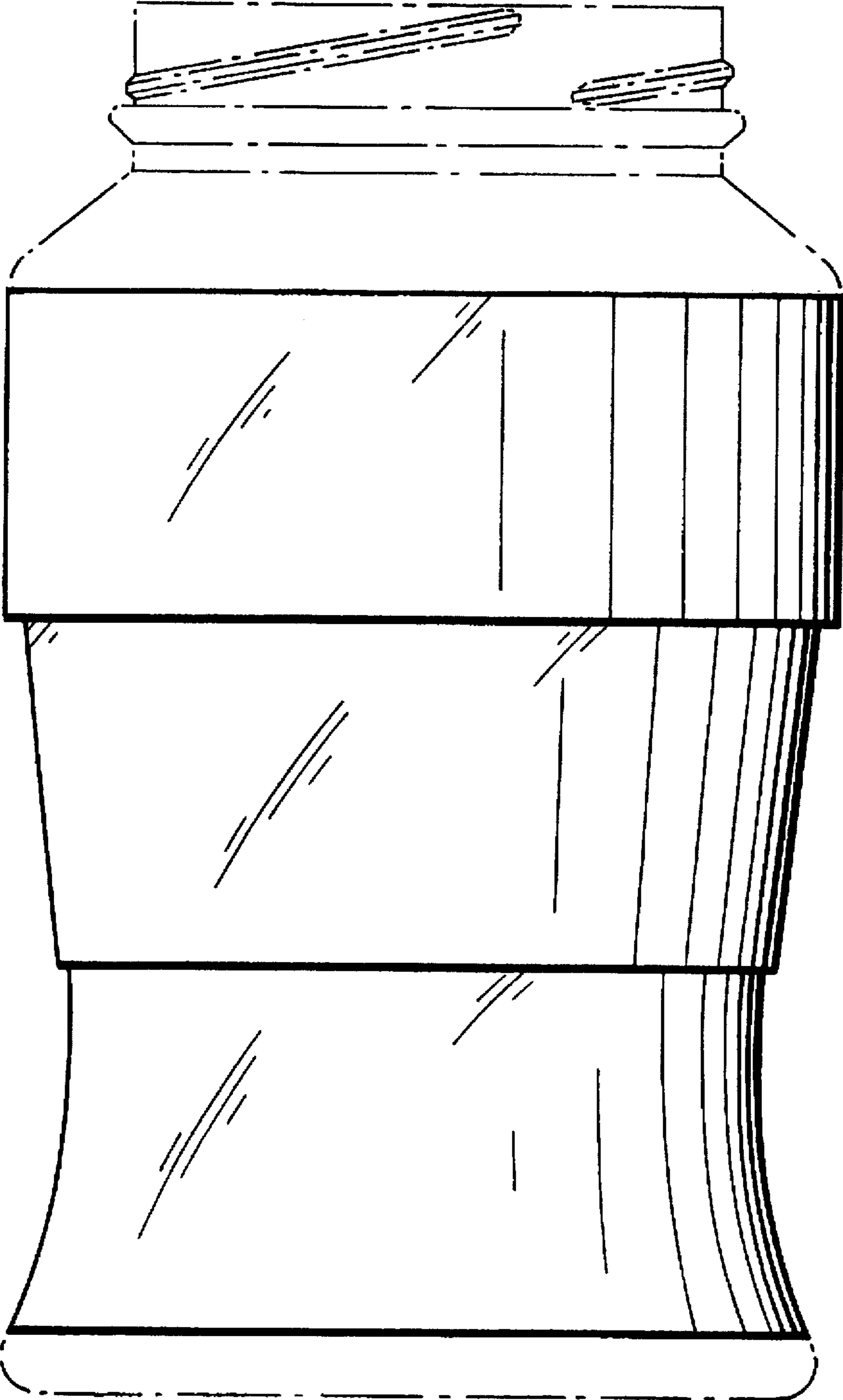

FIG. 5

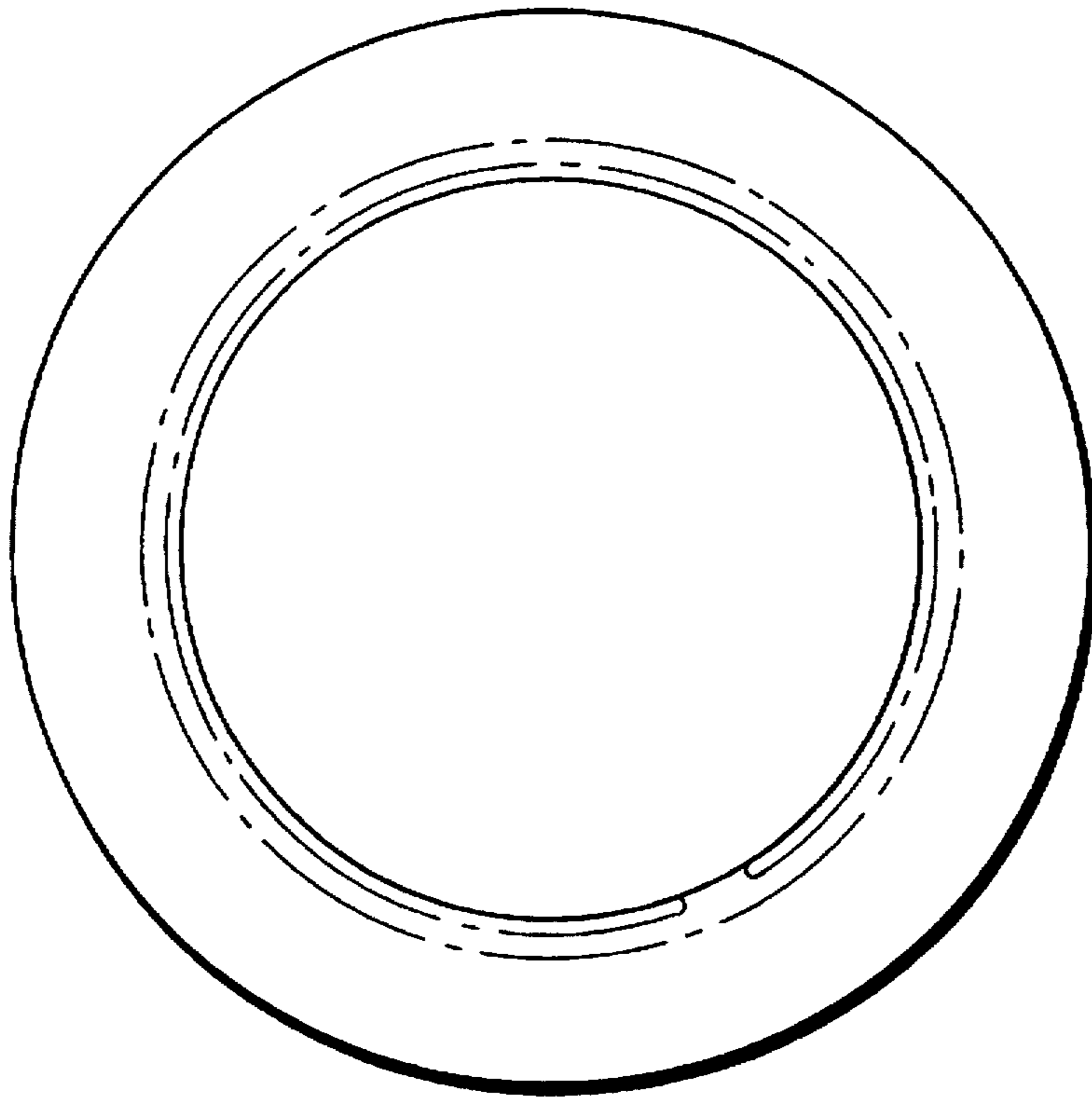

FIG. 6

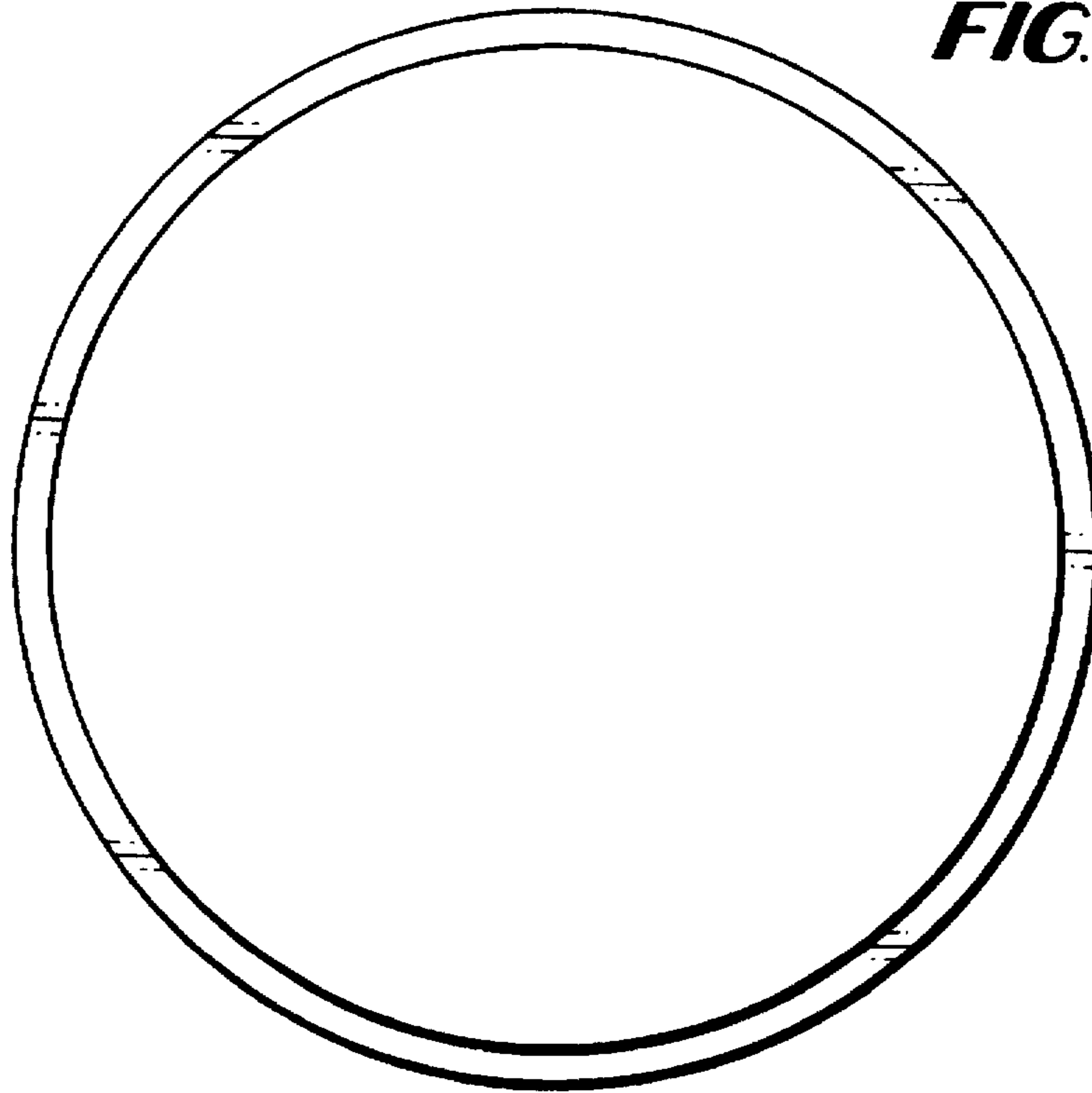

FIG. 7

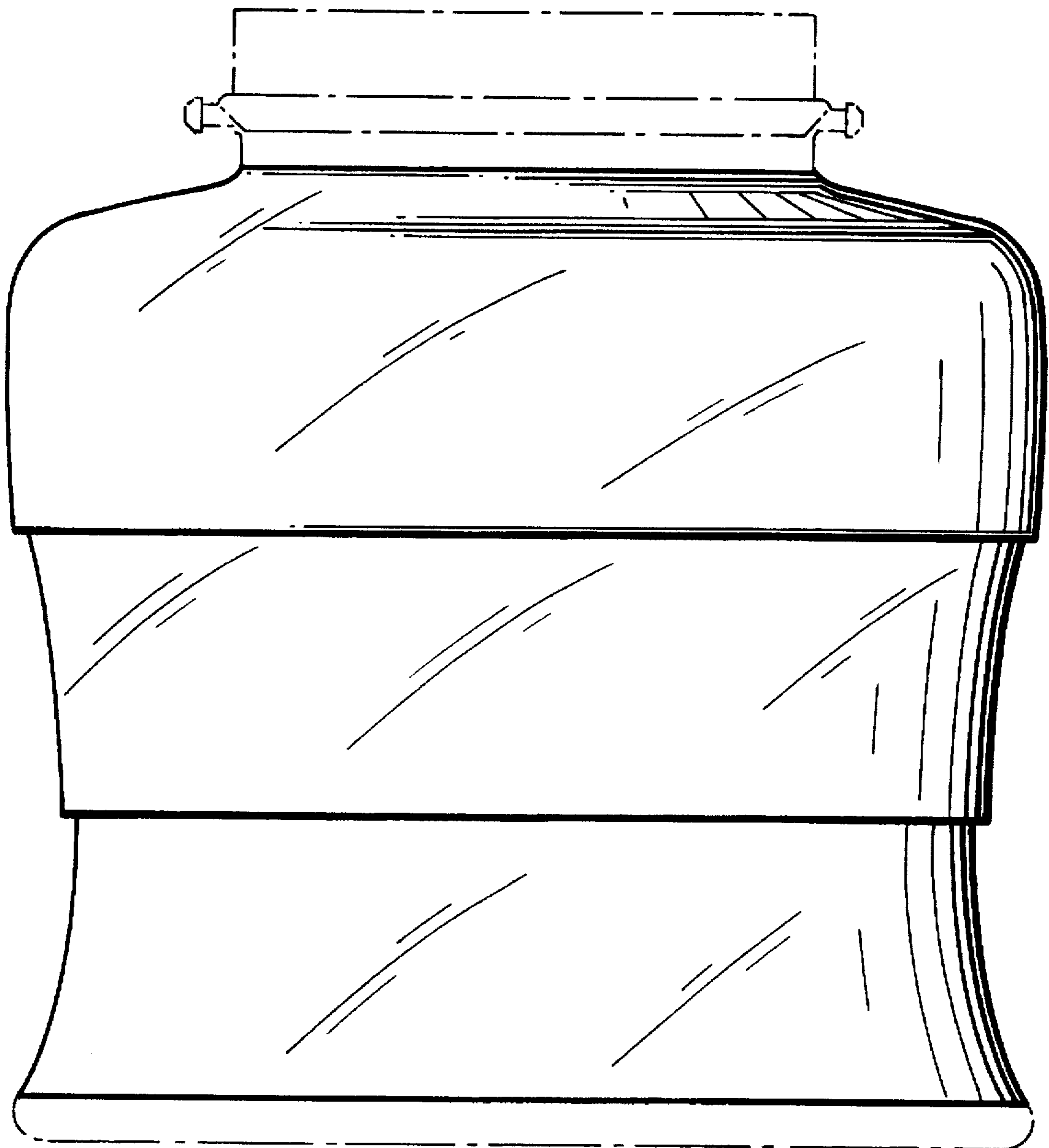

FIG. 8

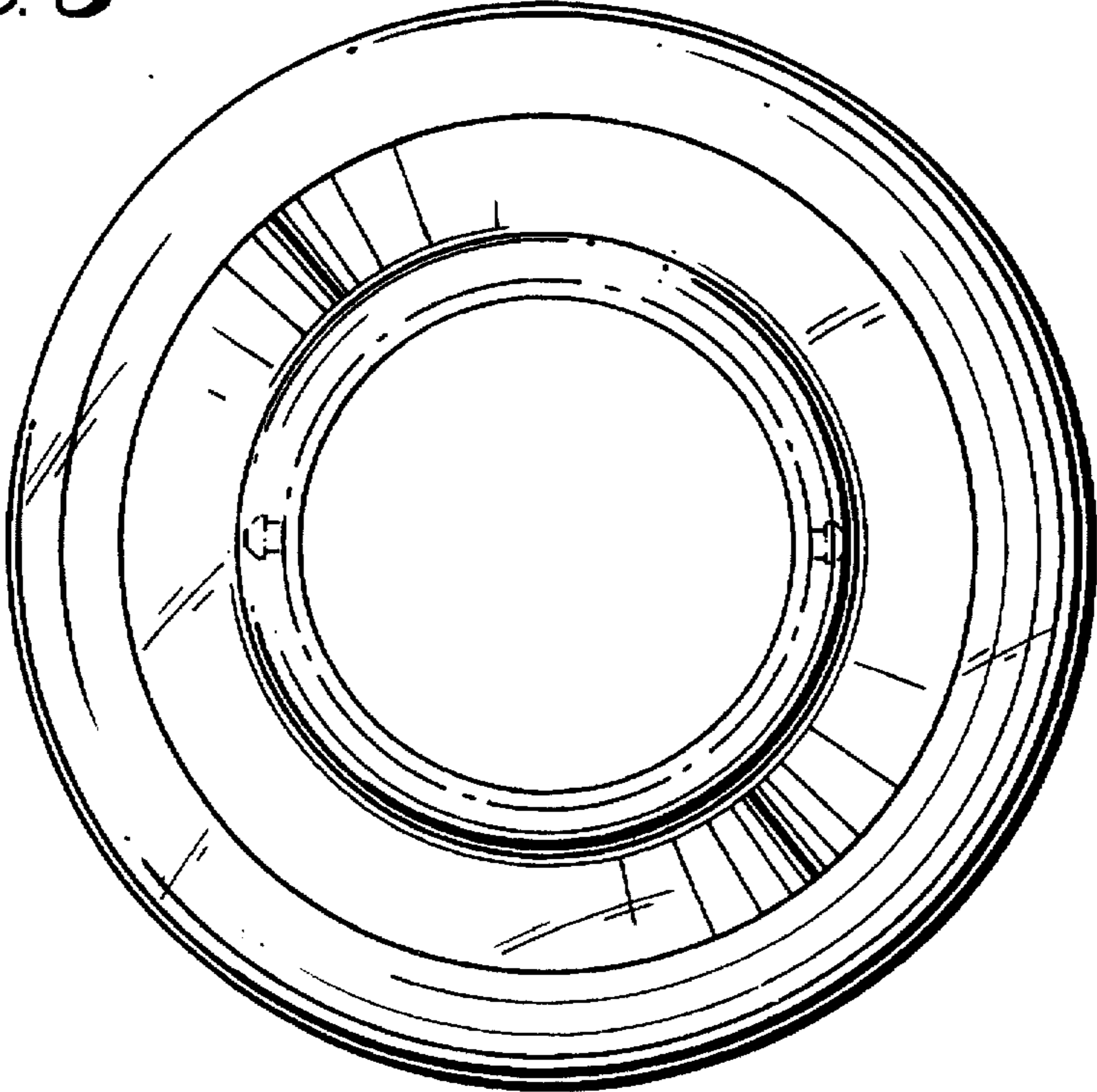

FIG. 9

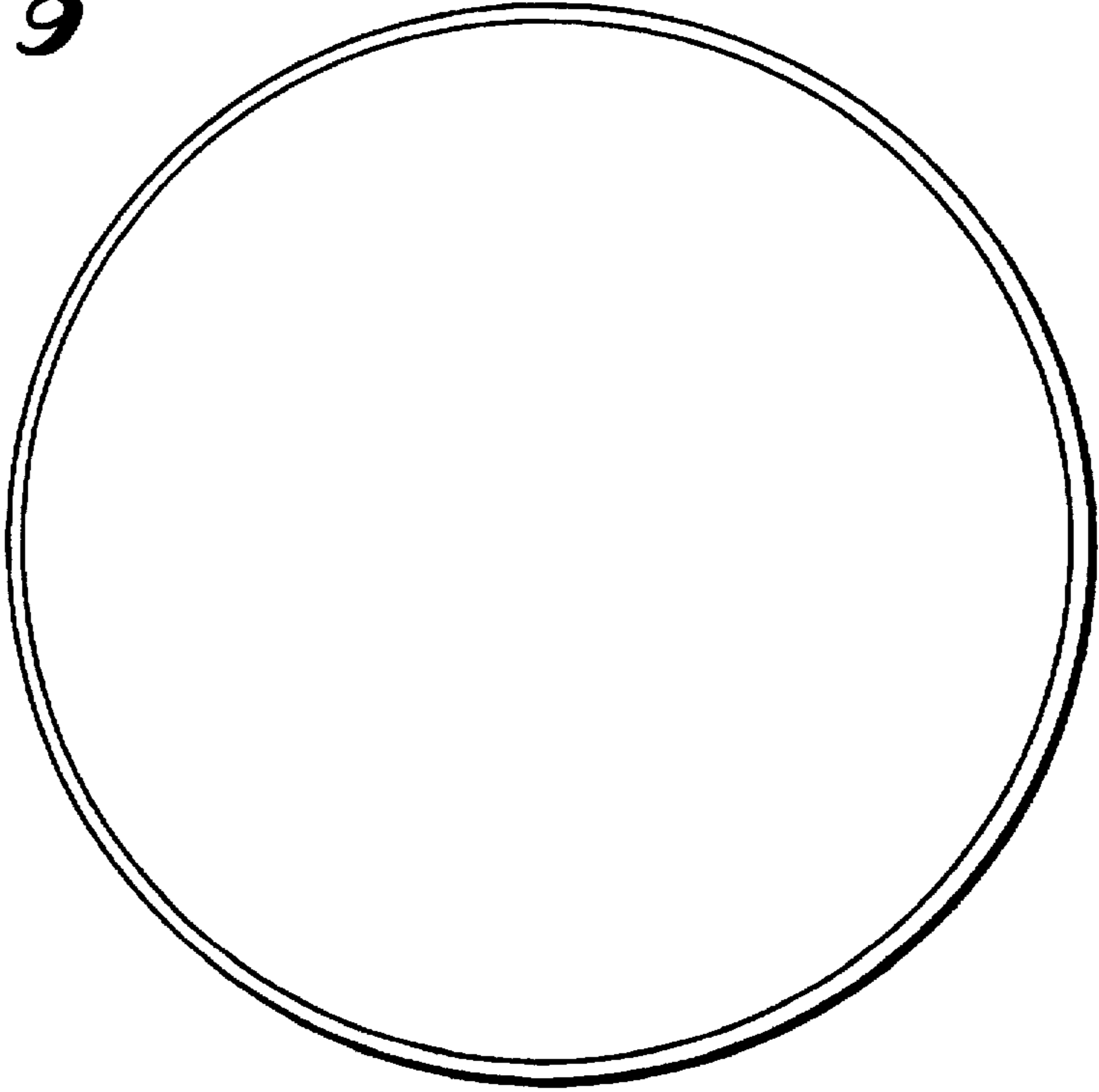

FIG. 10

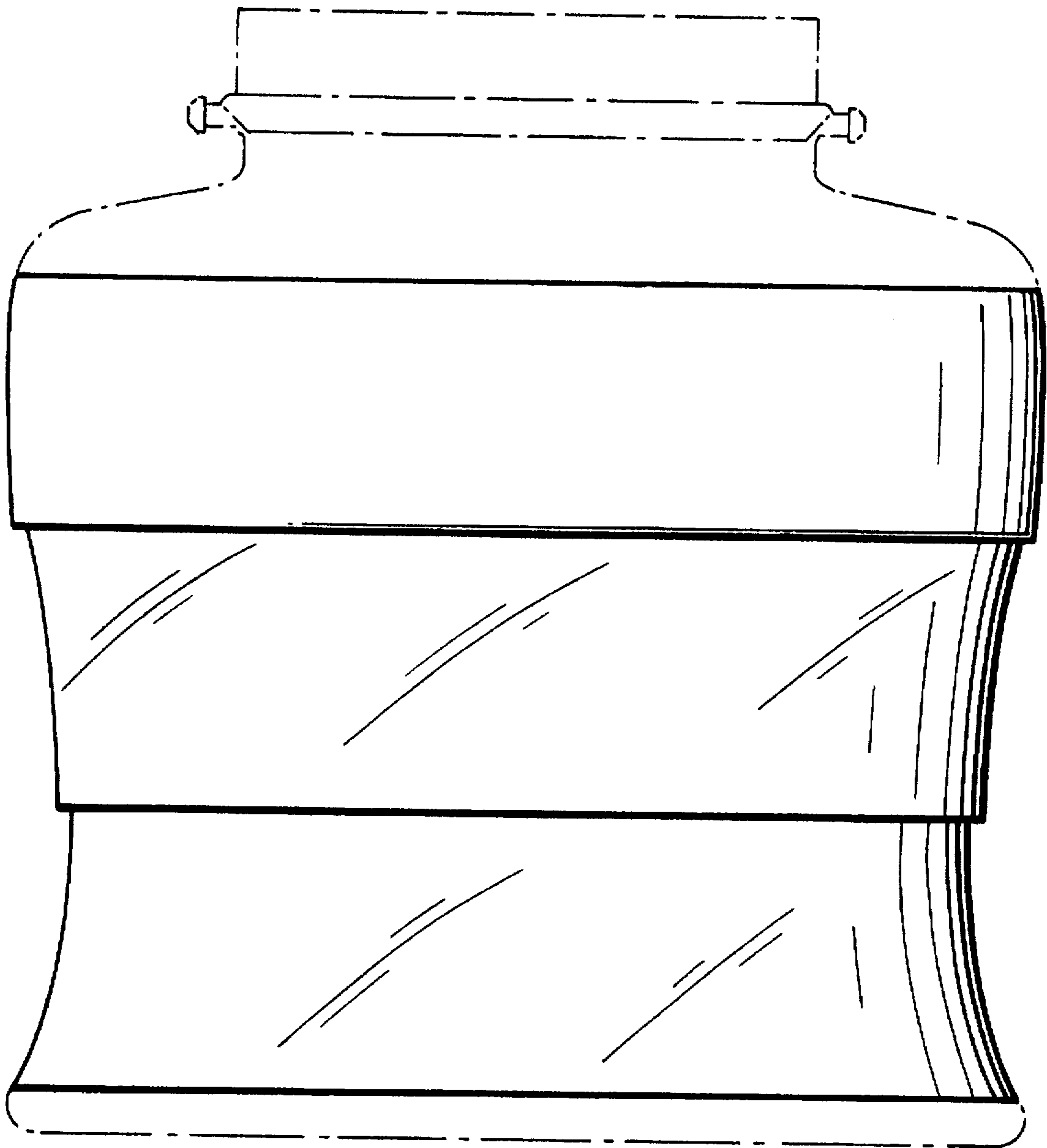

FIG. 11

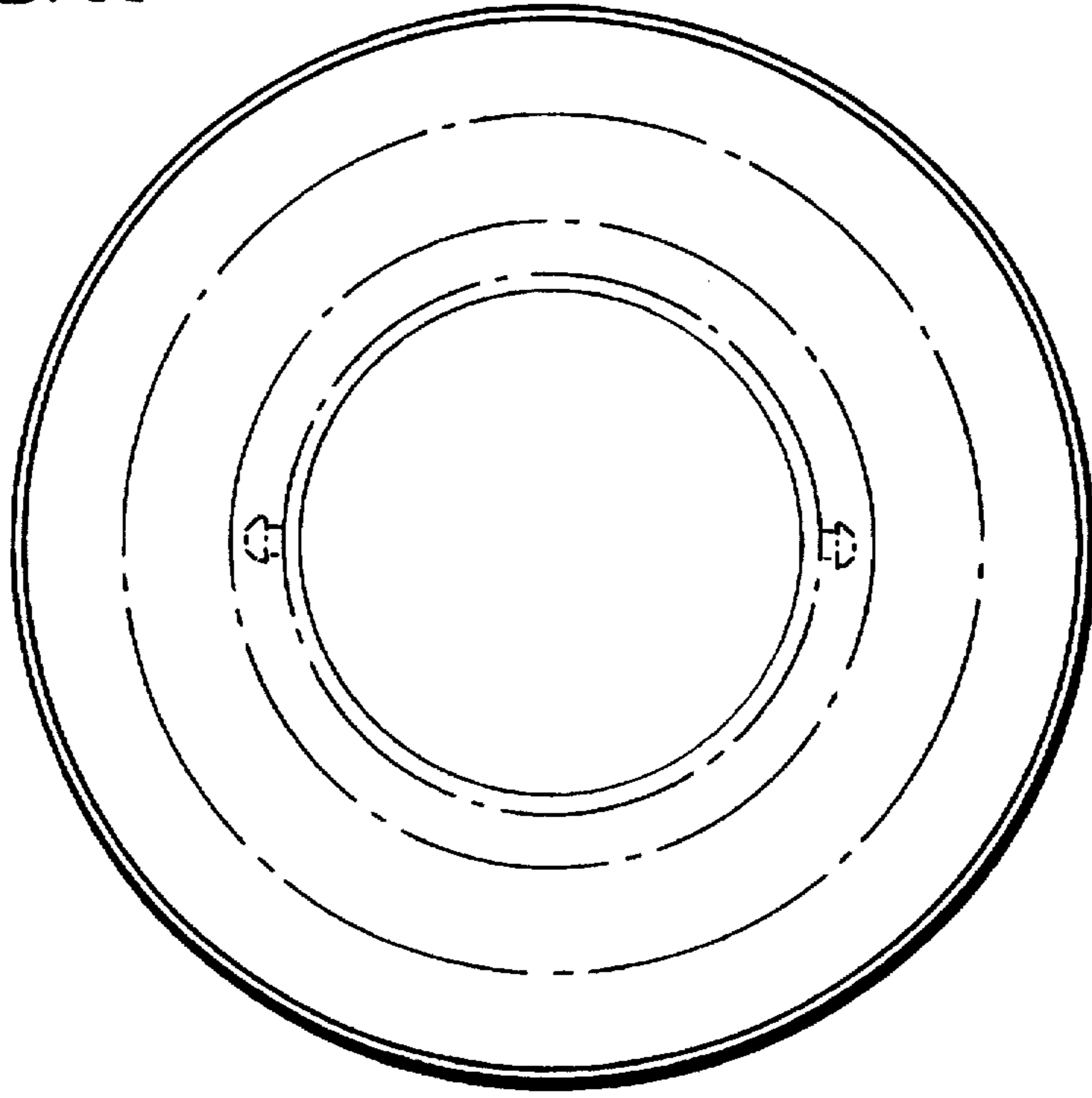

FIG. 12

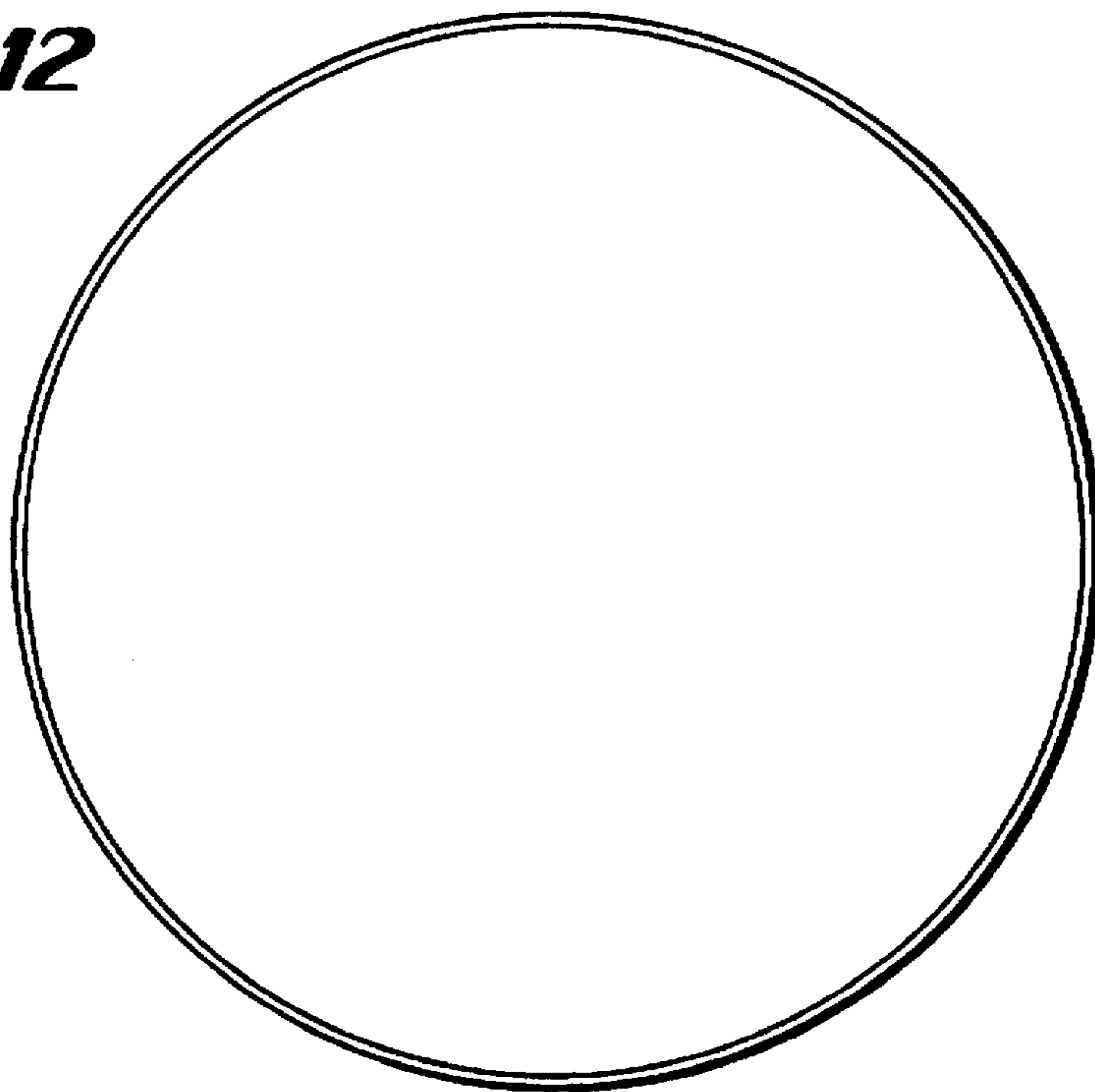

FIG. 13

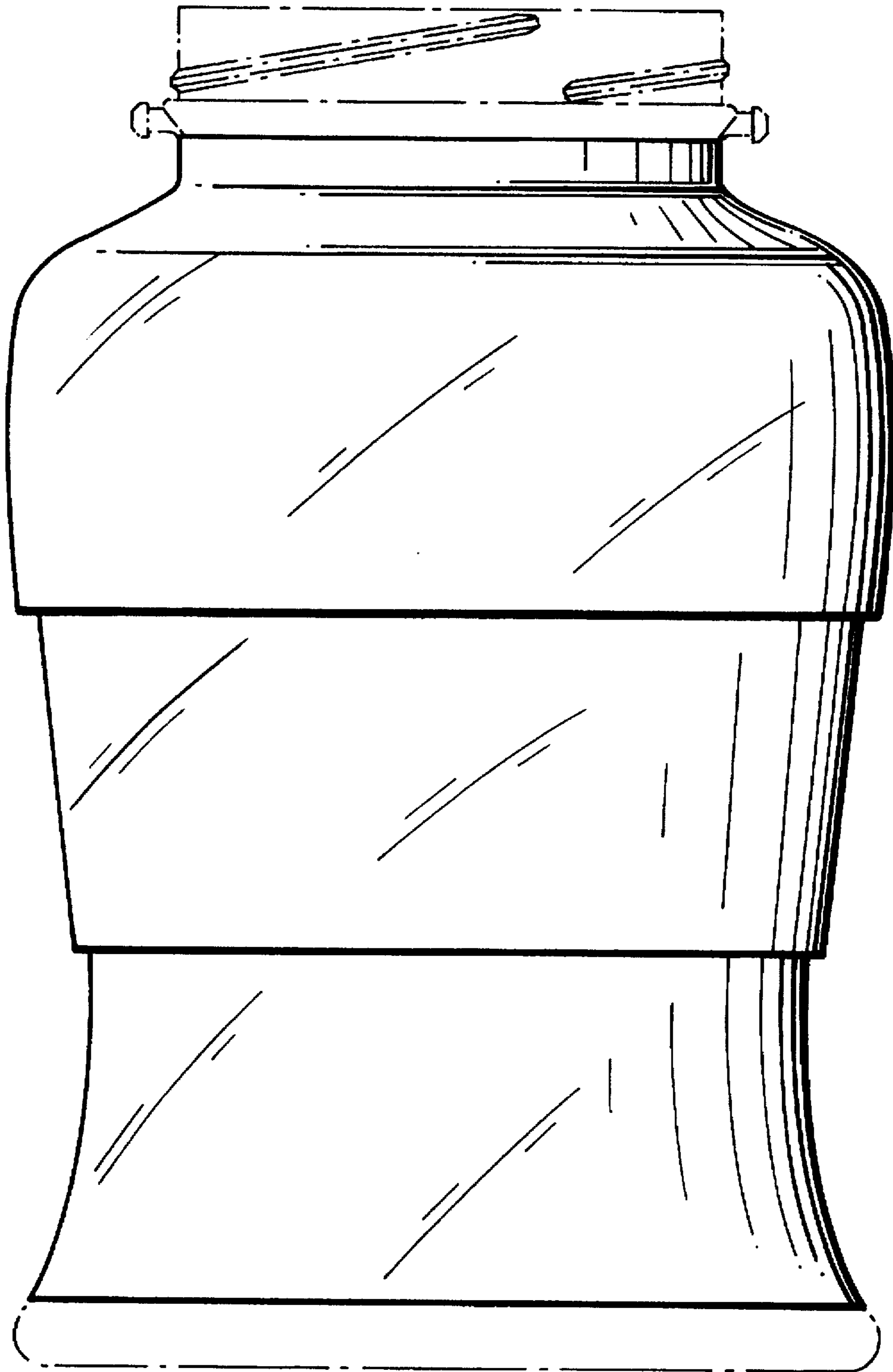

FIG. 14

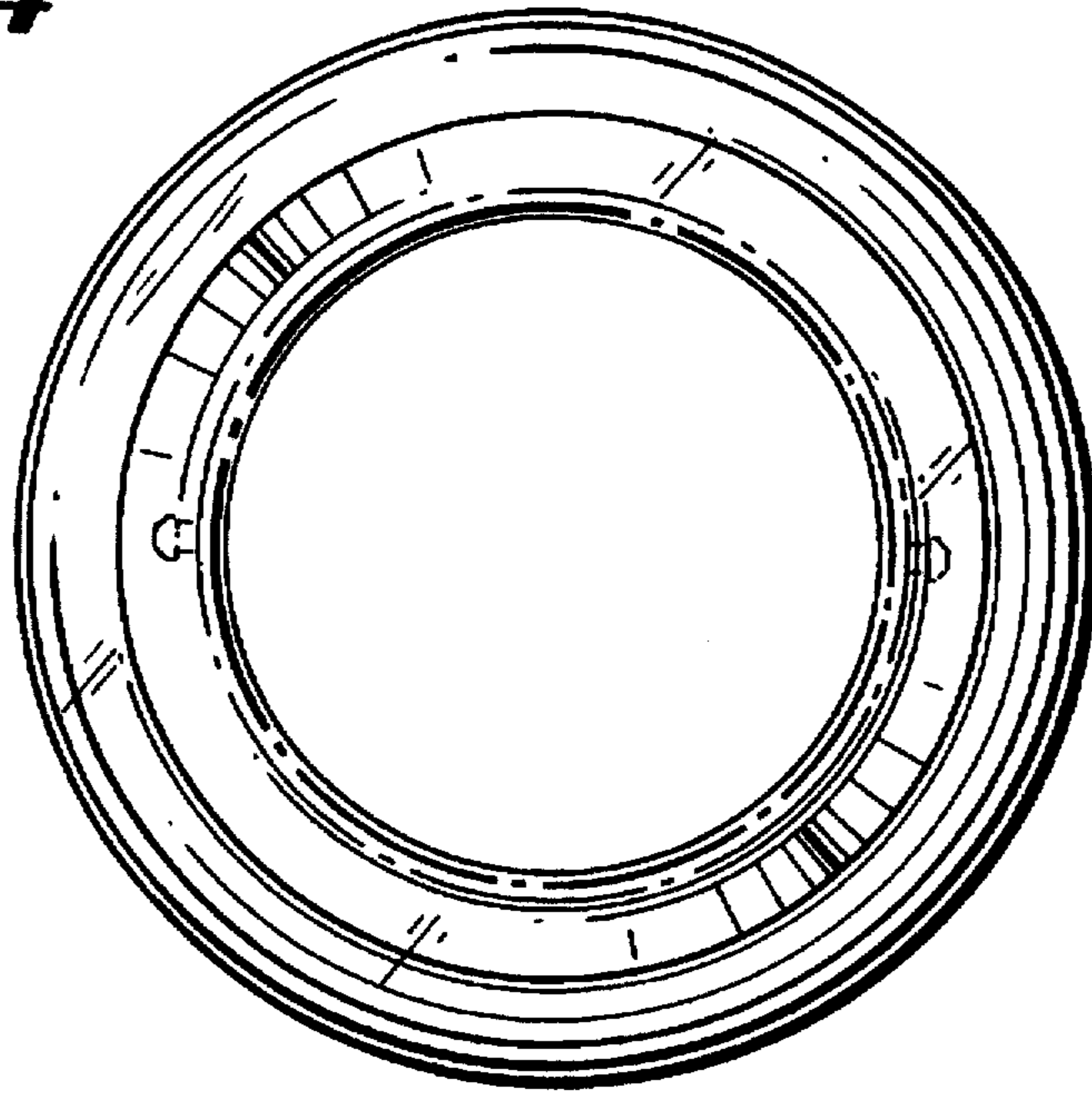

FIG. 15

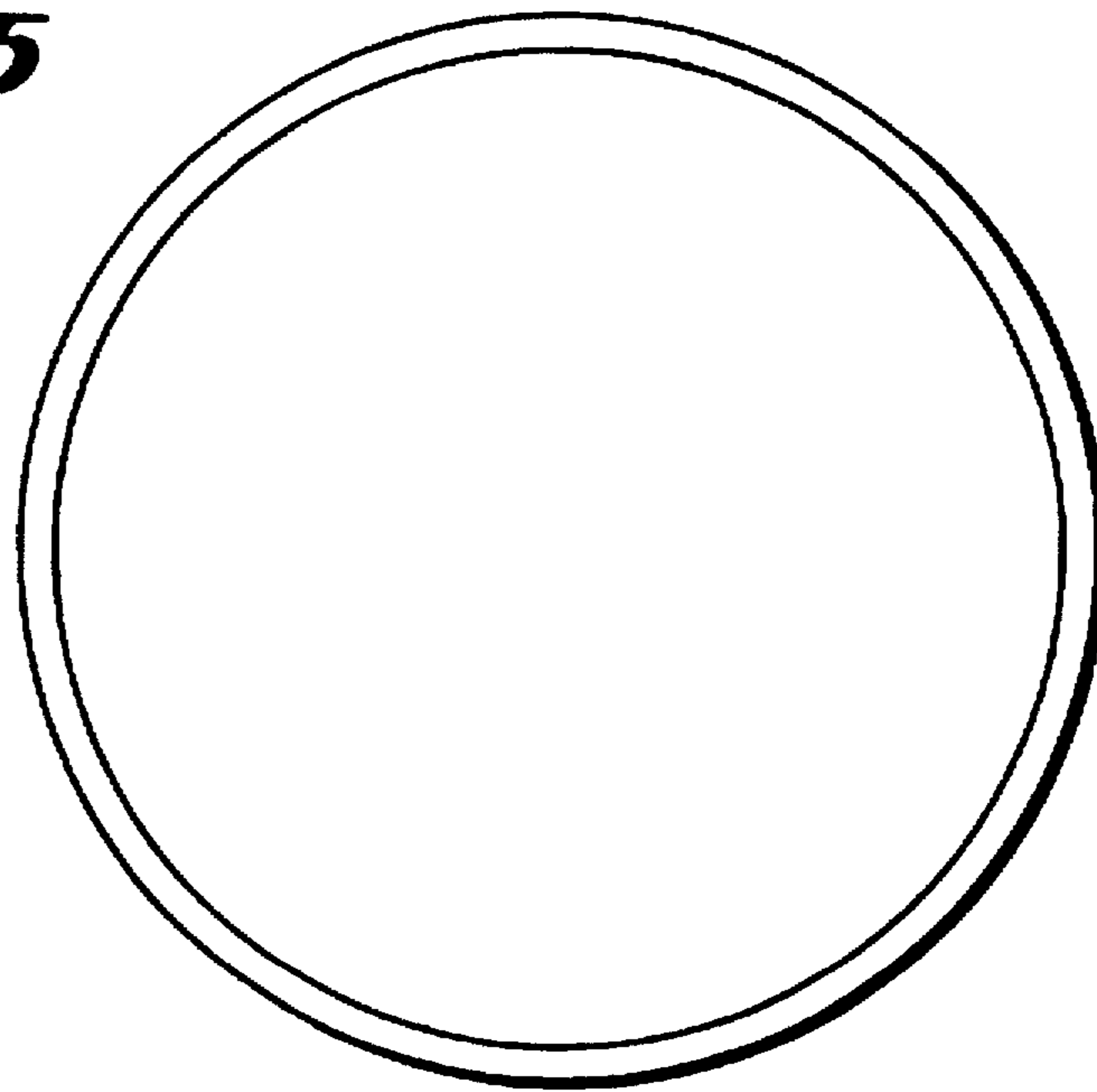

FIG. 16

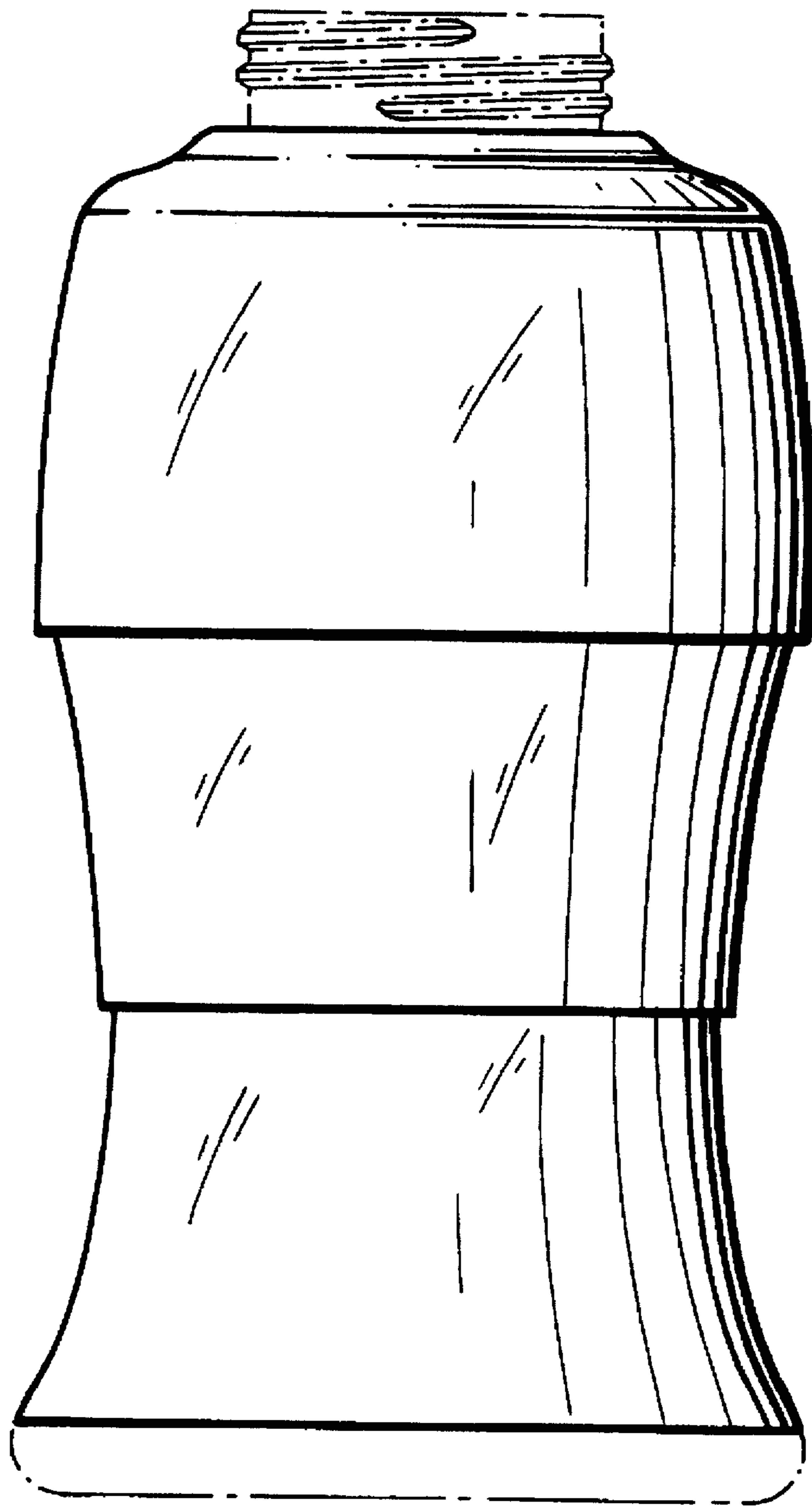

FIG. 17

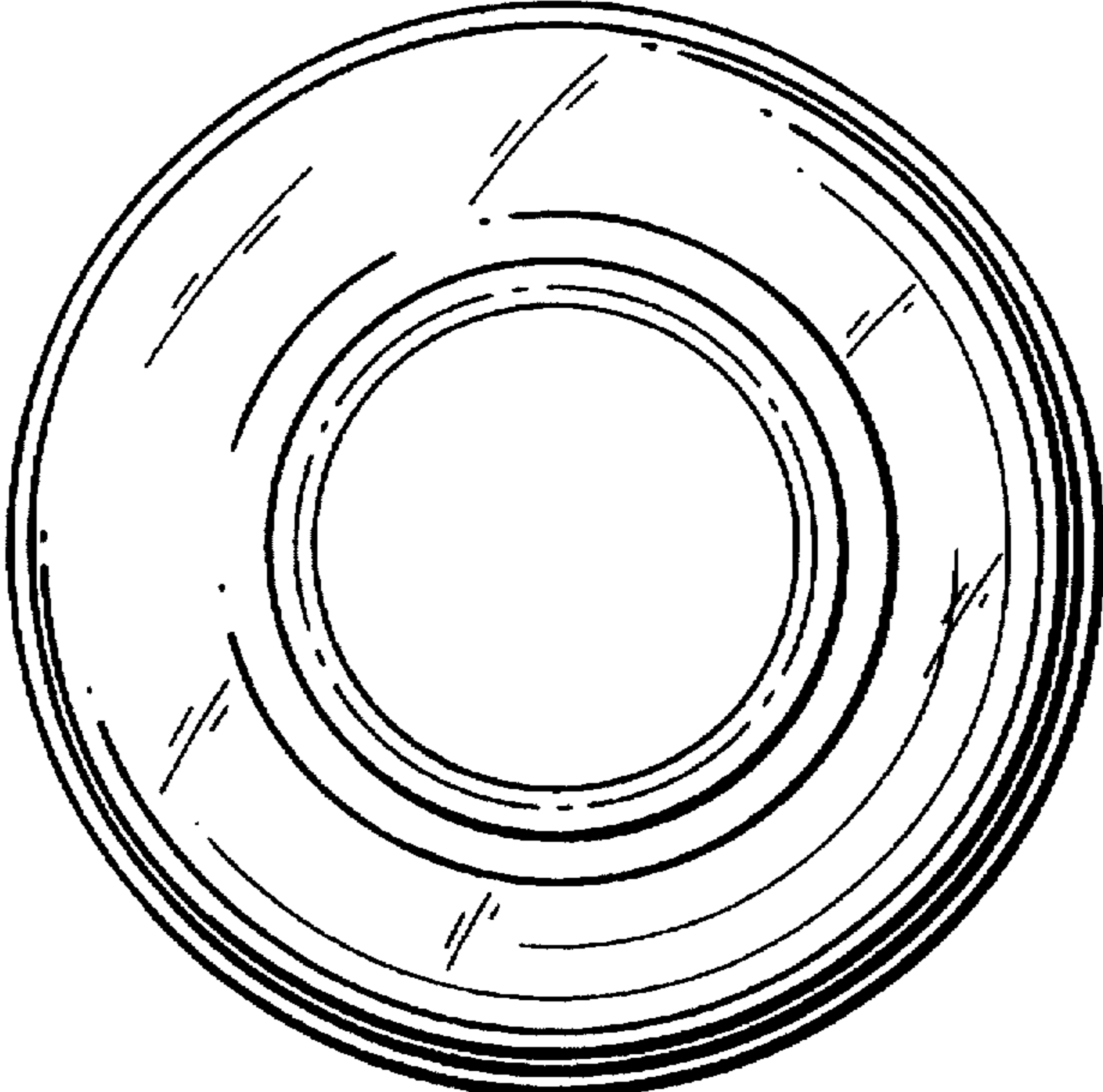

FIG. 18

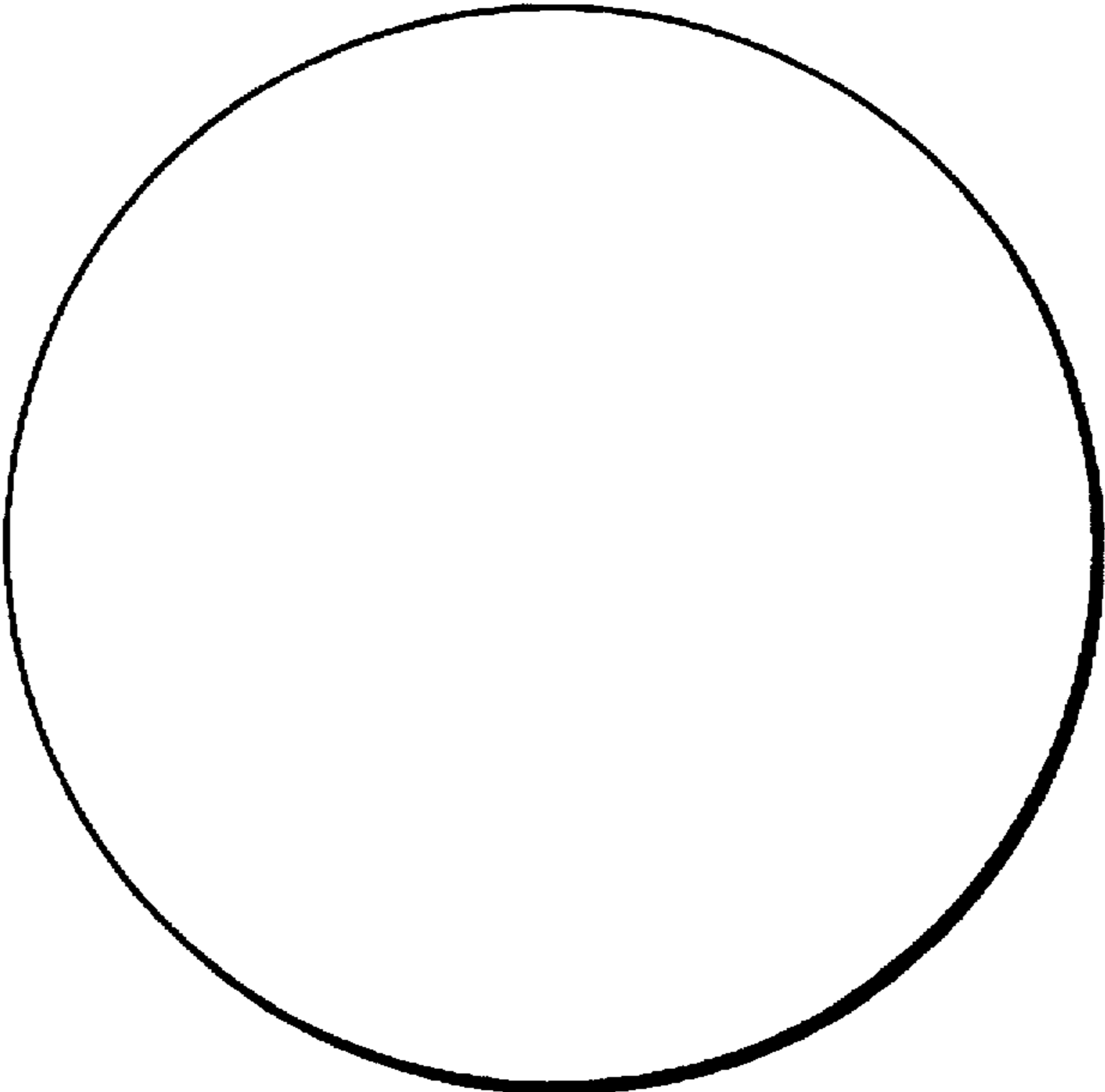

FIG. 19

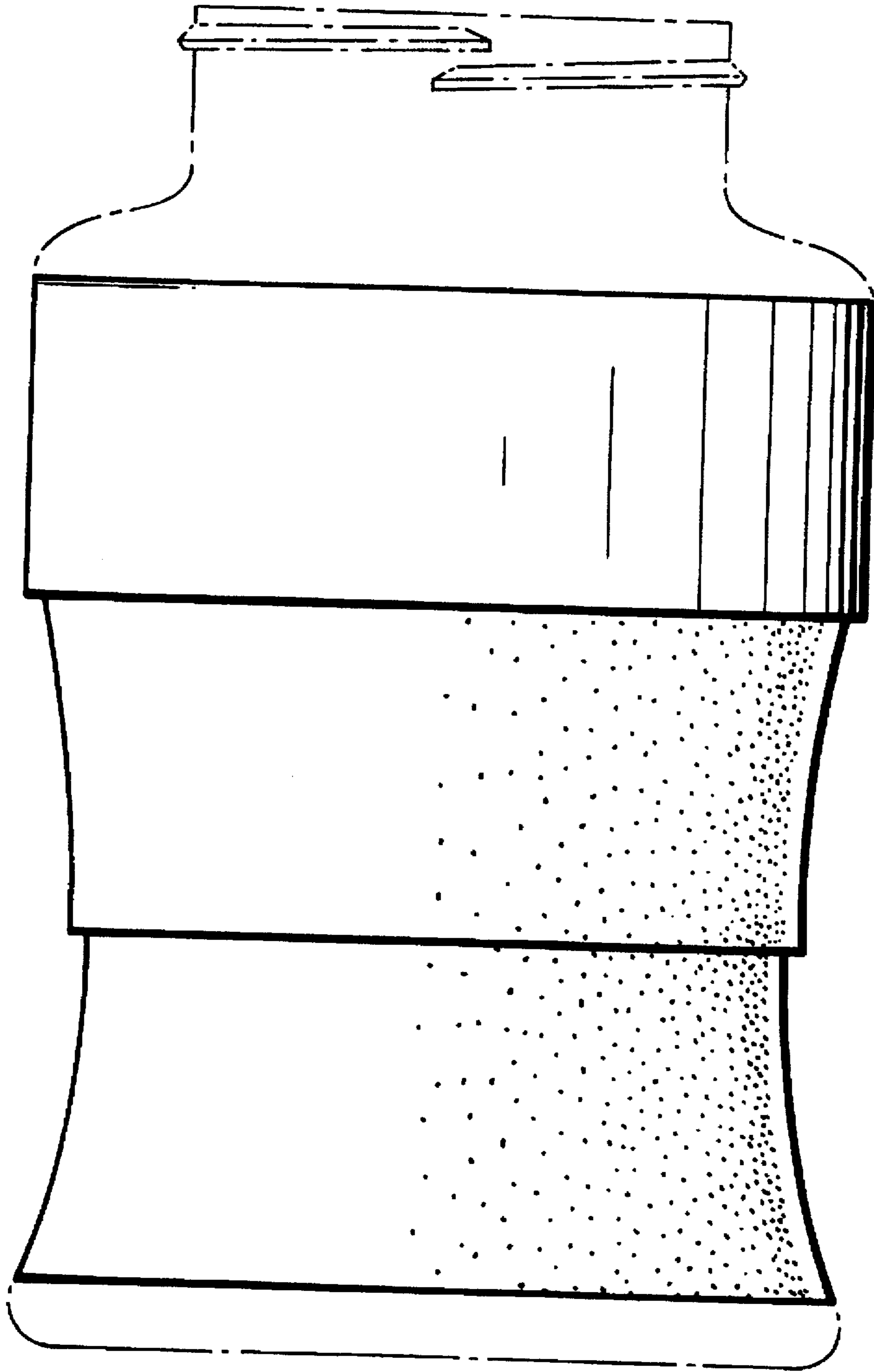

FIG. 20

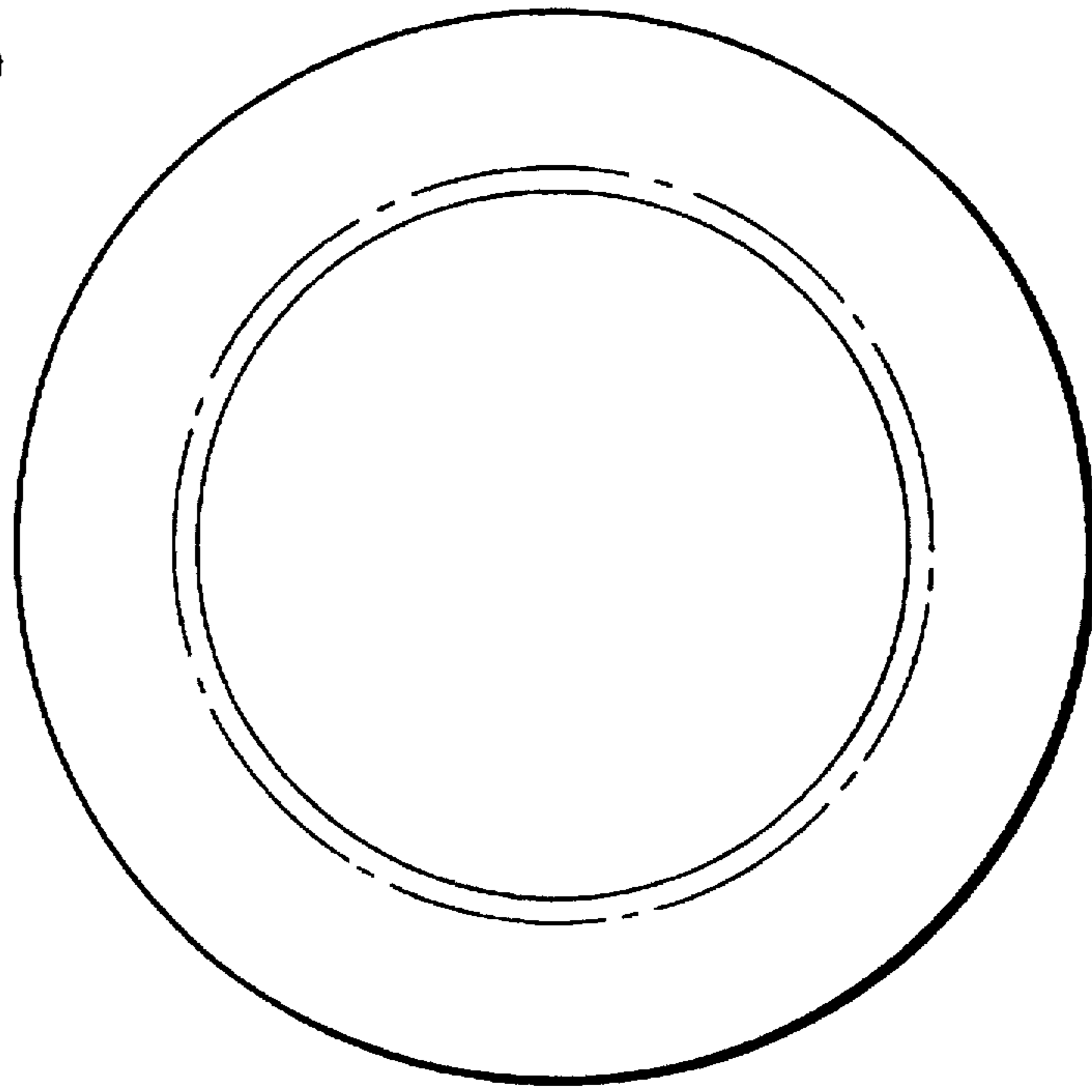

FIG. 21

