



US00D385054S

United States Patent [19]
Landefeld

[11] **Patent Number: Des. 385,054**
[45] **Date of Patent: **Oct. 14, 1997**

[54] **WALL MOUNTED LUMINAIRE**
[75] **Inventor: Cory W. Landefeld, Long Beach, Calif.**
[73] **Assignee: Kim Lighting Inc., City of Industry, Calif.**
[**] **Term: 14 Years**
[21] **Appl. No.: 57,496**
[22] **Filed: Jul. 26, 1996**

ELA Co. Flyer ©1989, Exterior Luminaire.
Bega Recessed Wall Luminaires AD, ©1987, Semi-Recessed Luminaire #2939P.
Barrier Lighting—Mariner (1 sheet) Oct. 23, 1987.
Design with Lighting—1 Sheet 1993.
ELA Company—Alzak Reflector System (1 sheet) 1989.
BEGA/FS A Forms & Surfaces Company (1 sheet) 1987.

Primary Examiner—Susan J. Lucas
Attorney, Agent, or Firm—Lyon & Lyon LLP

Related U.S. Application Data

[62] Division of Ser. No. 37,405, Apr. 12, 1995.
[51] **LOC (6) Cl. 26-05**
[52] **U.S. Cl. D26/85**
[58] **Field of Search D26/72, 80, 85, D26/87, 92, 67, 68; 362/147, 432, 362, 267, 290, 279, 376**

[57] **CLAIM**

The ornamental design for a wall mounted luminaire, as shown and described.

DESCRIPTION

FIG. 1 is a front perspective view of a wall mounted luminaire showing my new design;
FIG. 2 is a front elevational view thereof;
FIG. 3 is a top plan view thereof;
FIG. 4 is a side elevational view thereof;
FIG. 5 is a bottom plan view thereof;
FIG. 6 is a top plan view of a second embodiment of the design;
FIG. 7 is a side elevational view thereof;
FIG. 8 is a bottom plan view thereof;
FIG. 9 is a top plan view of a third embodiment of the design;
FIG. 10 is a side elevational view thereof;
FIG. 11 is a bottom plan view thereof; and,
FIG. 12 is a rear elevational view.
The front and rear configurations shown in FIGS. 2 and 12 are common to the first, second, and third embodiments.

[56] **References Cited**

U.S. PATENT DOCUMENTS

D. 75,869	7/1928	Pfeiffer	D26/152
D. 107,954	8/1938	Barrett	D26/24
D. 110,954	8/1938	Barrett	D26/24
D. 350,213	8/1994	Druffel et al.	D26/85 X
D. 361,400	8/1995	Compton	D26/85
5,251,118	10/1993	Budnovitch et al.	362/147 X

OTHER PUBLICATIONS

Barrie Lighting, Flyer, Marine Wall Light.
Design with Lighting Catalog, 1993, p. 36, Synco Visa Wall Light (E).

1 Claim, 1 Drawing Sheet

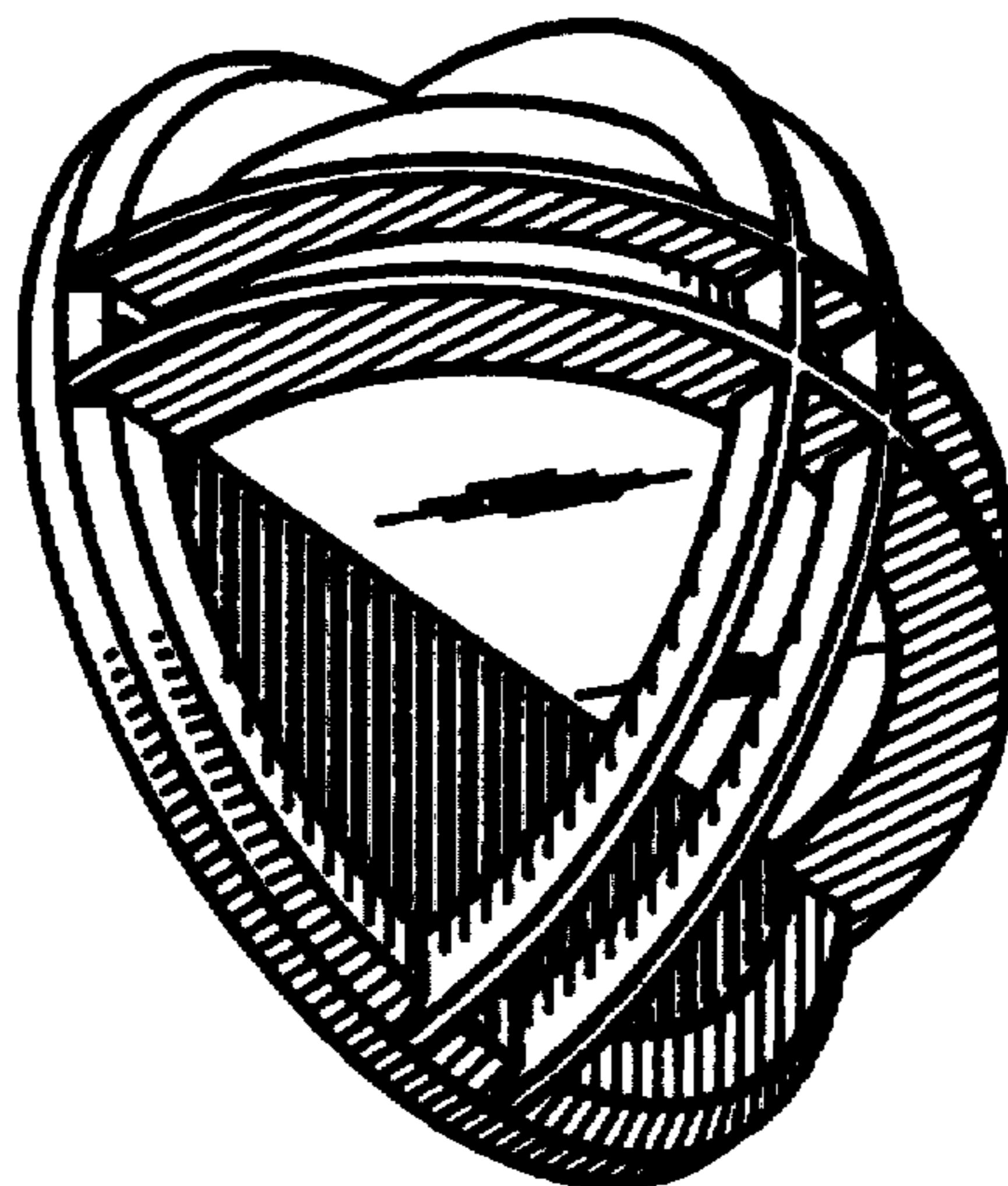

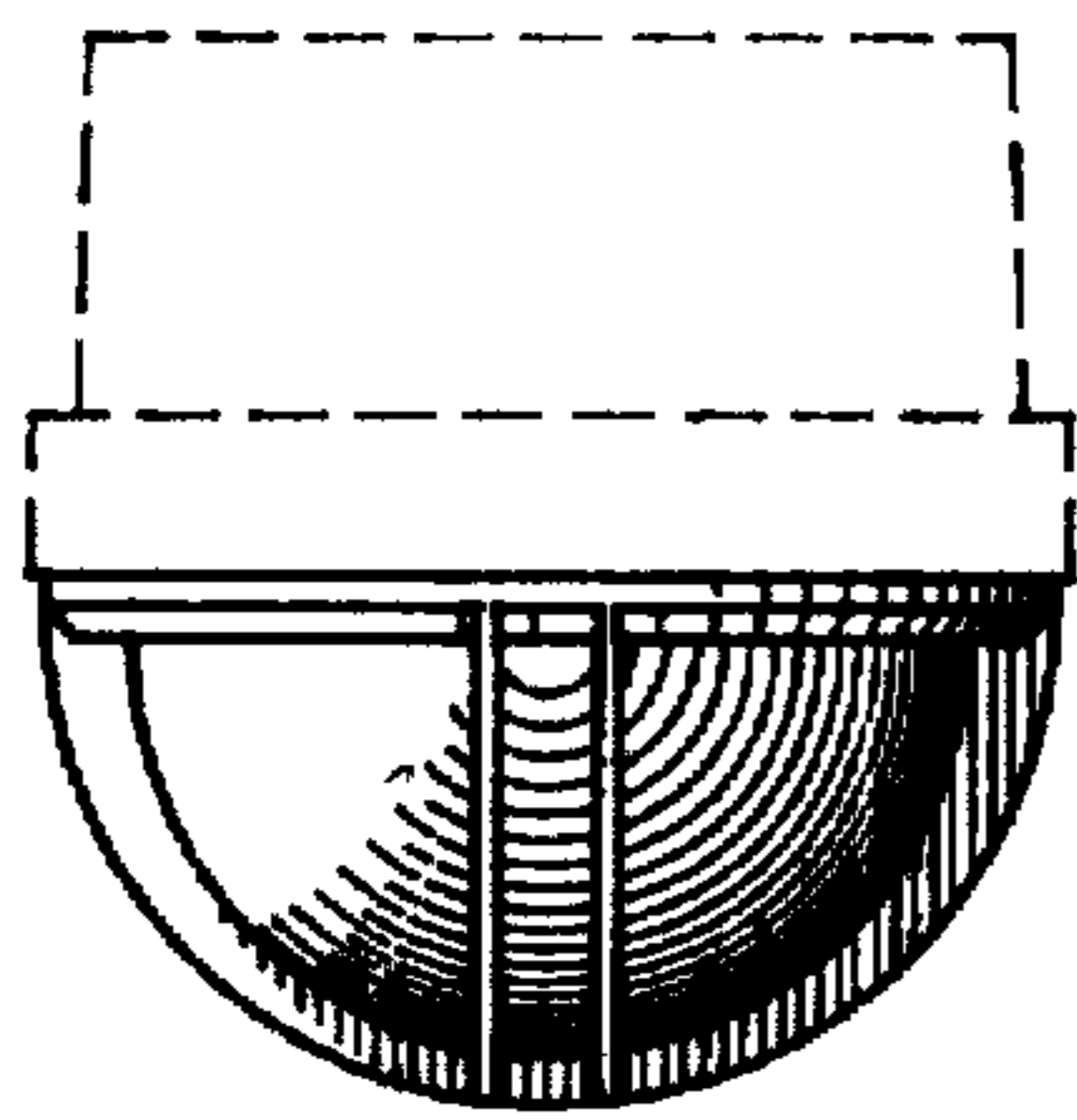

FIG. 9

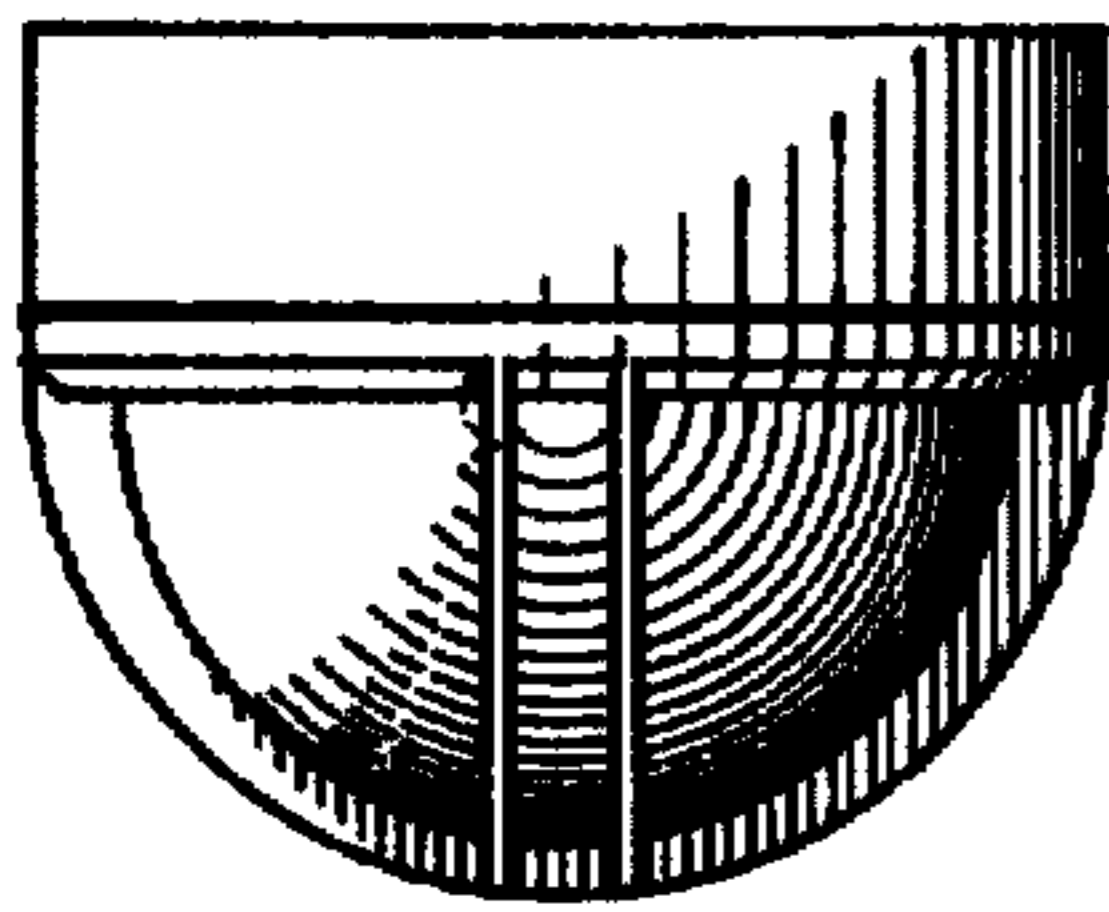

FIG. 6

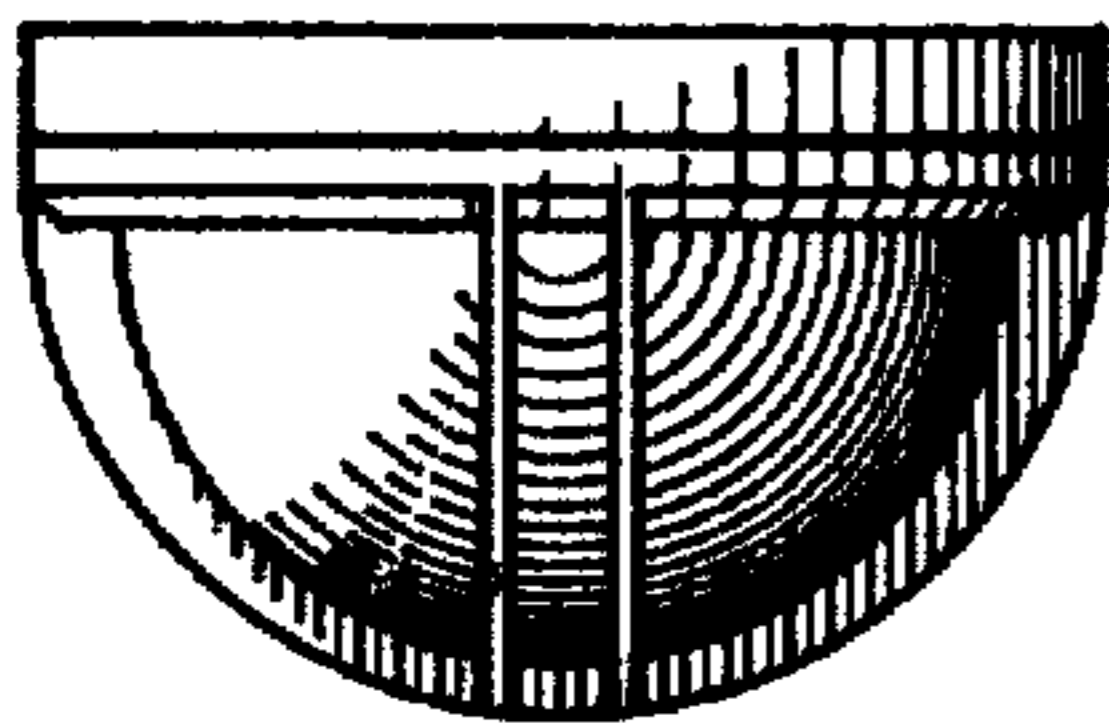

FIG. 3

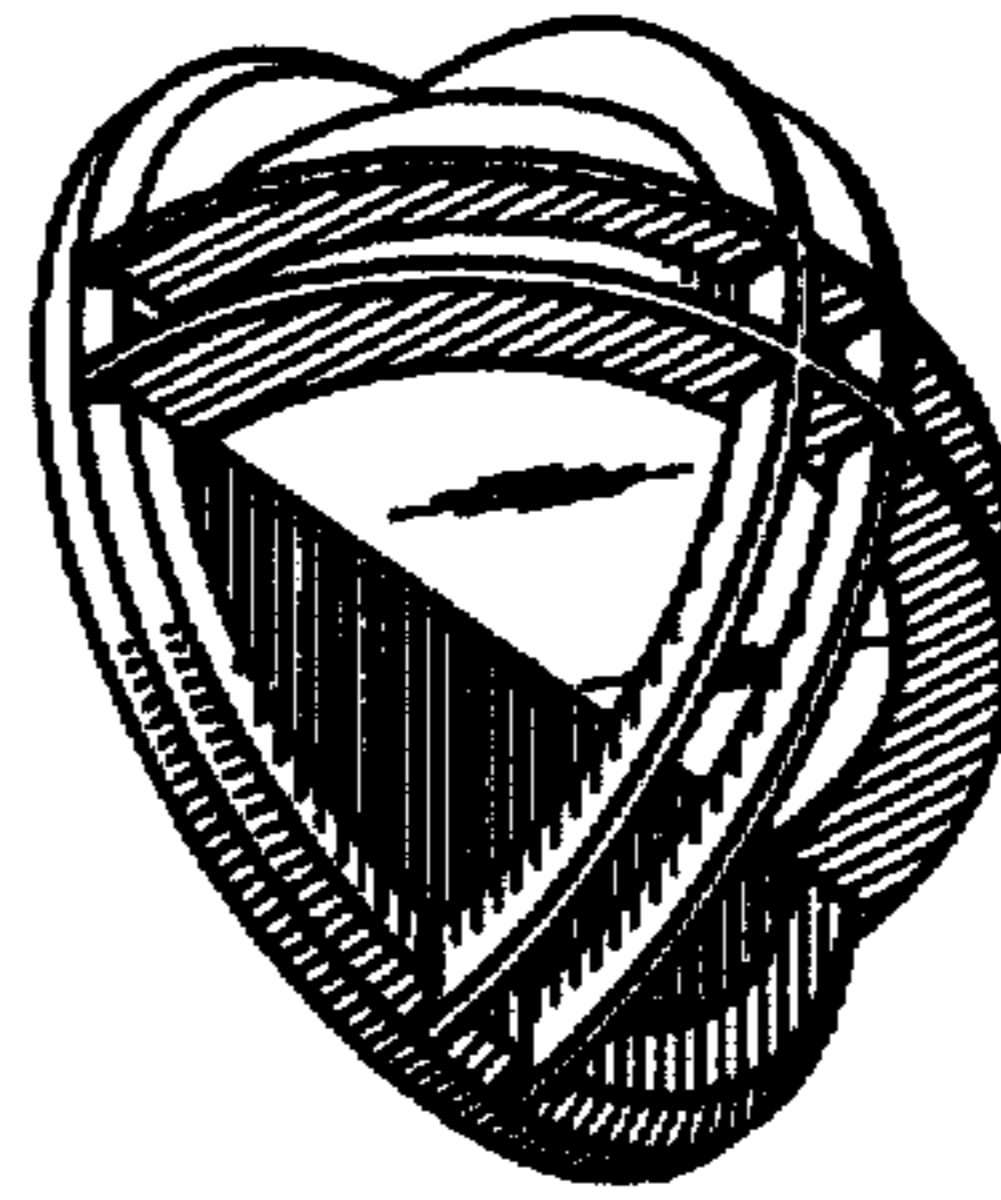

FIG. 1

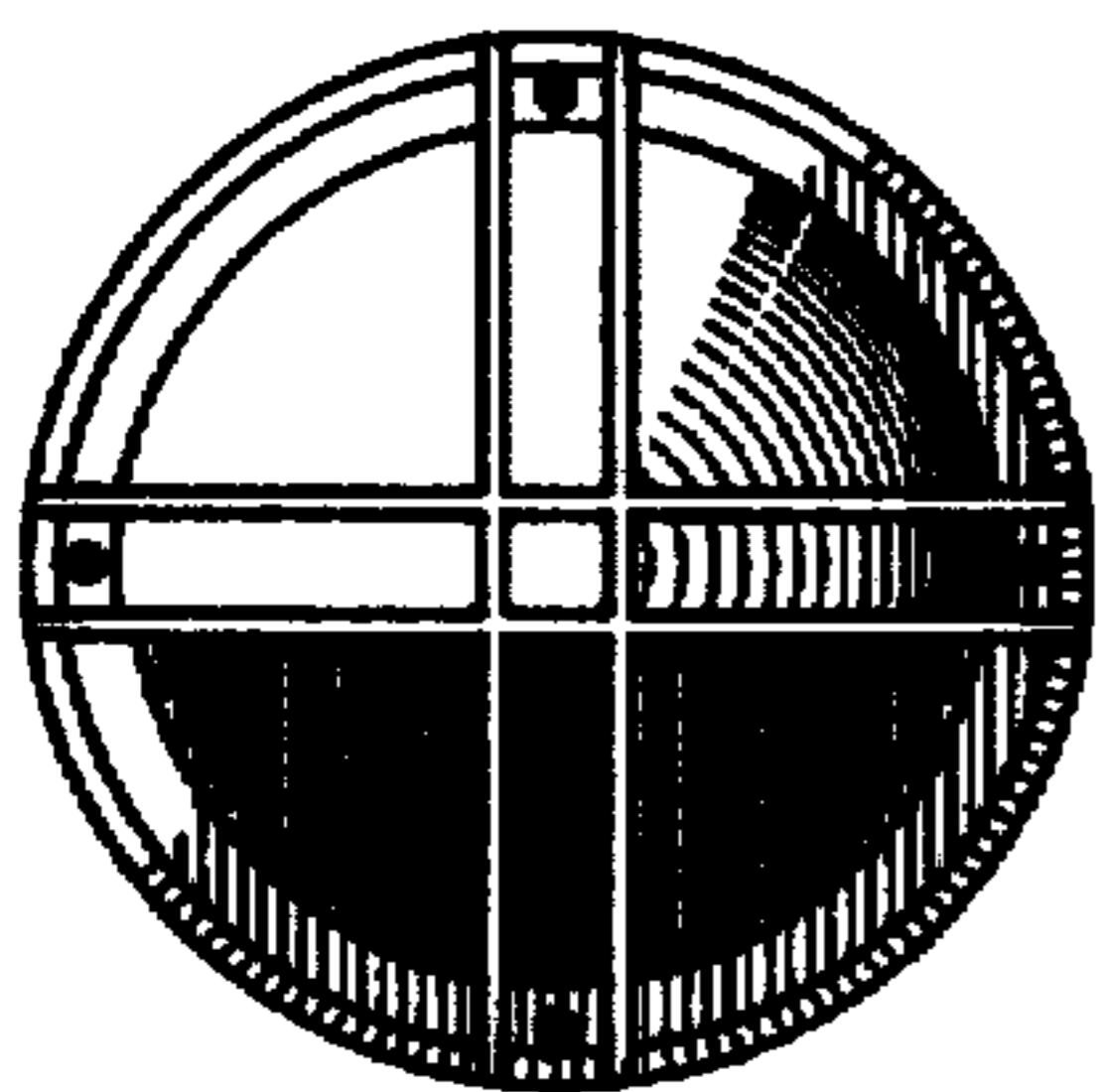

FIG. 2

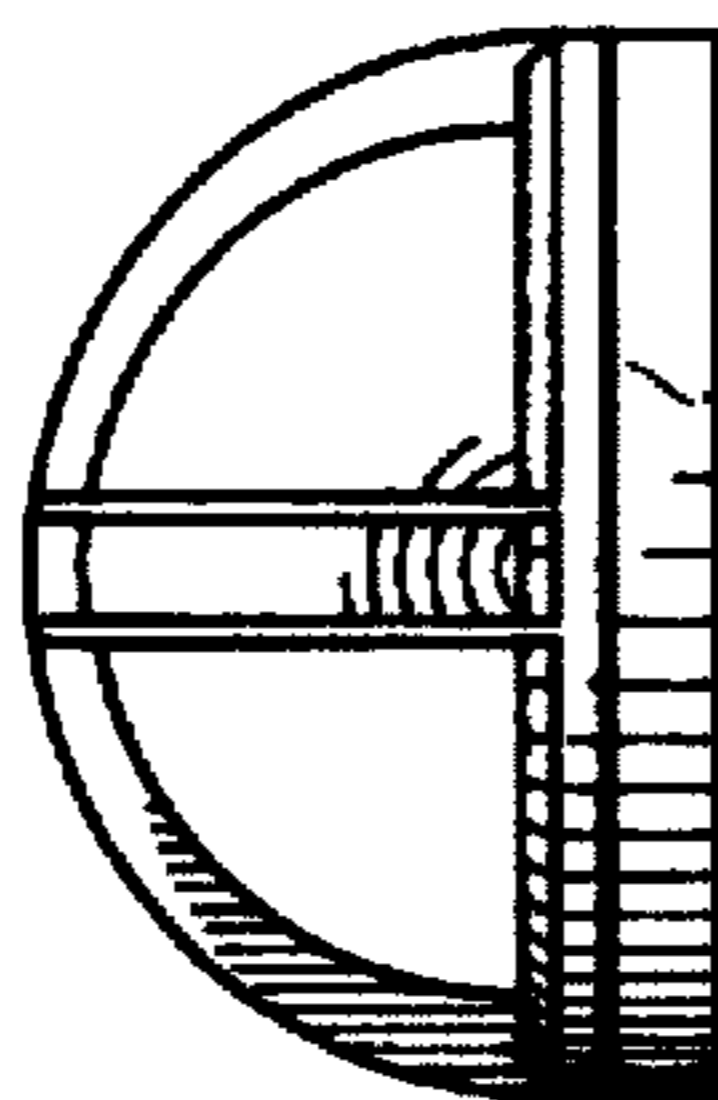

FIG. 4

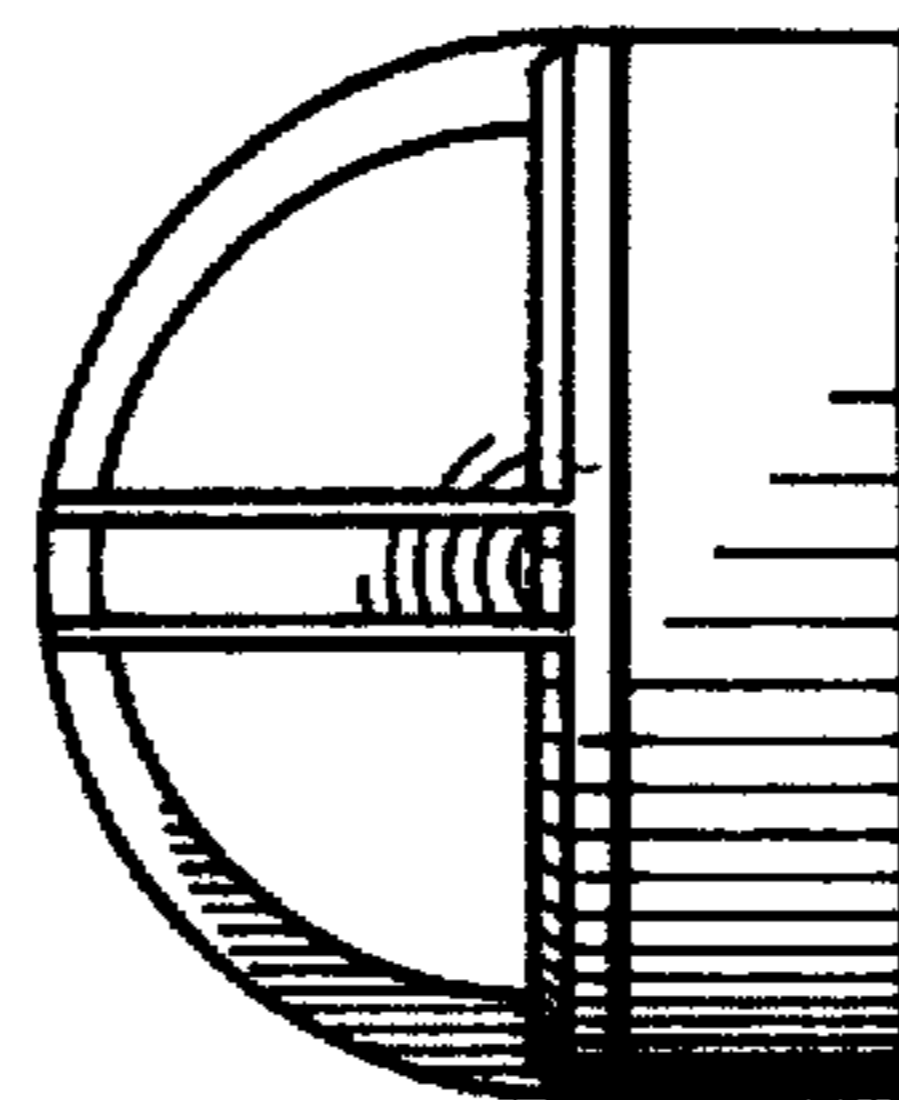

FIG. 7

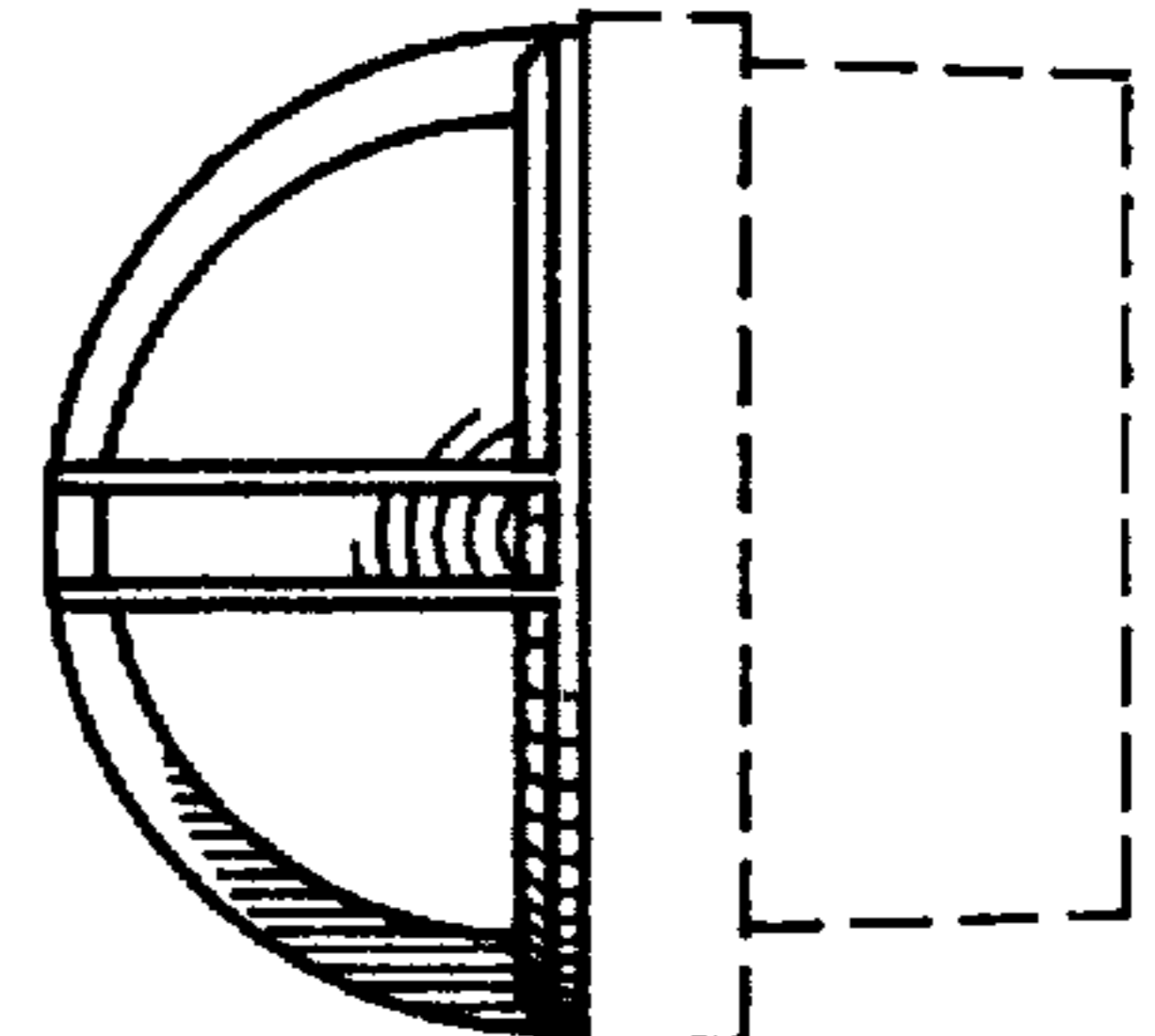

FIG. 10

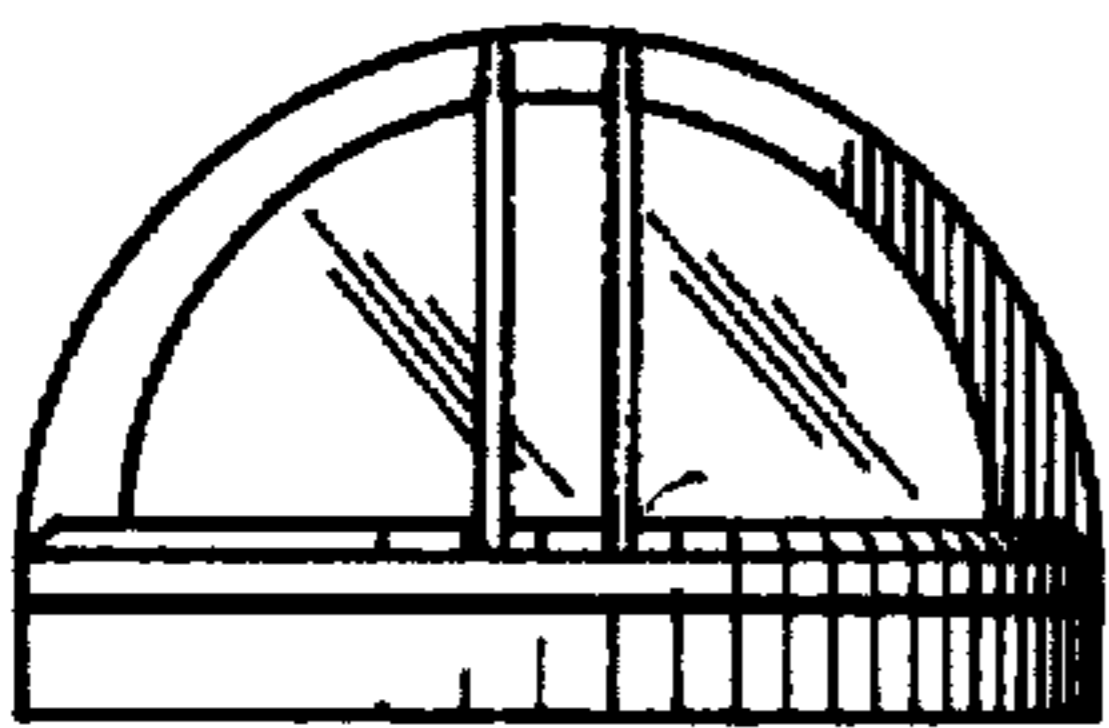

FIG. 5

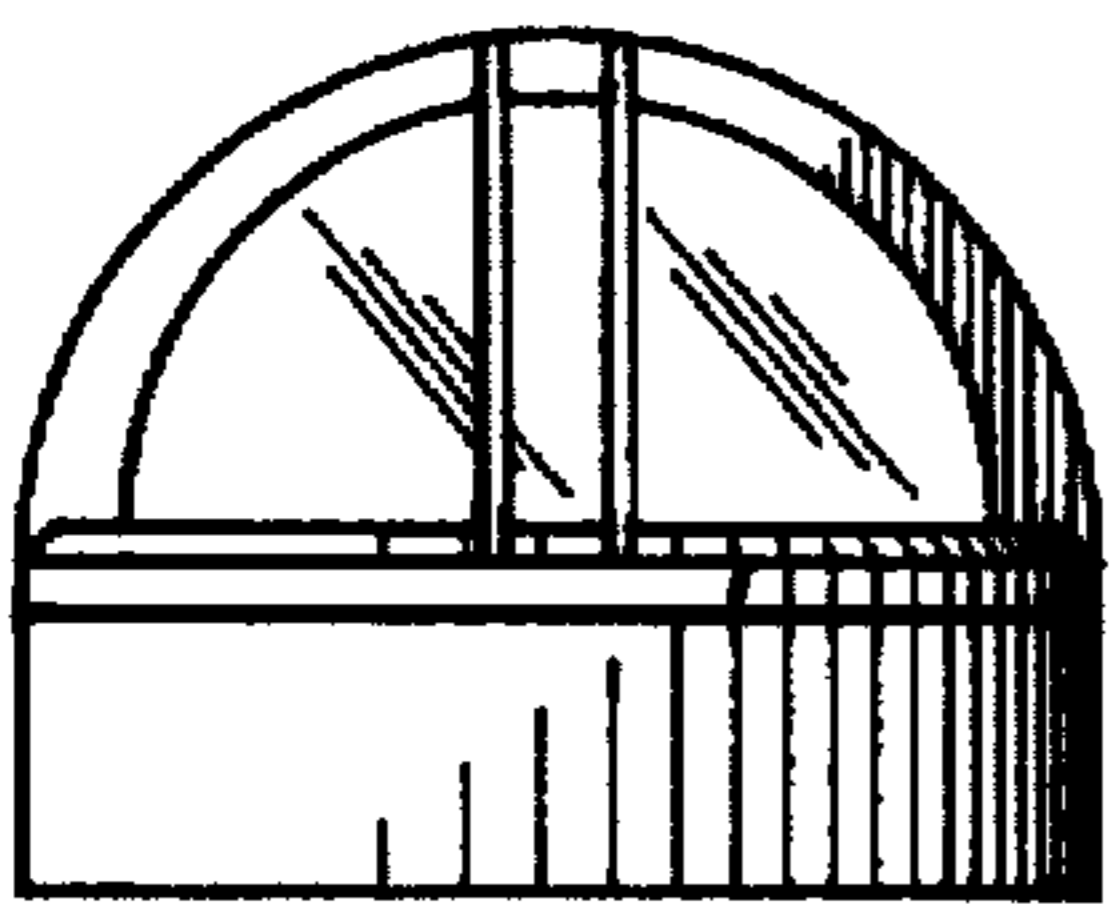

FIG. 8

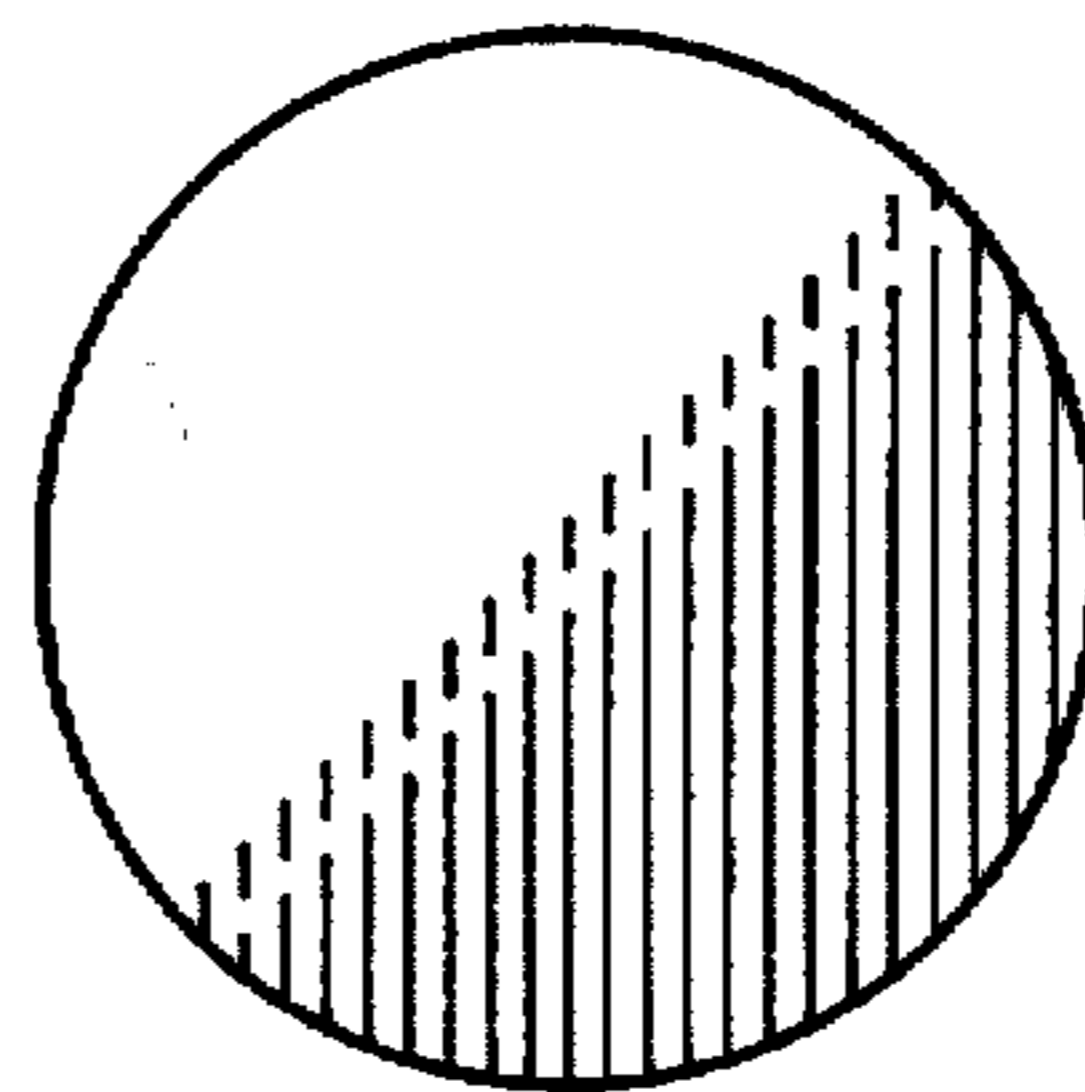

FIG. 12

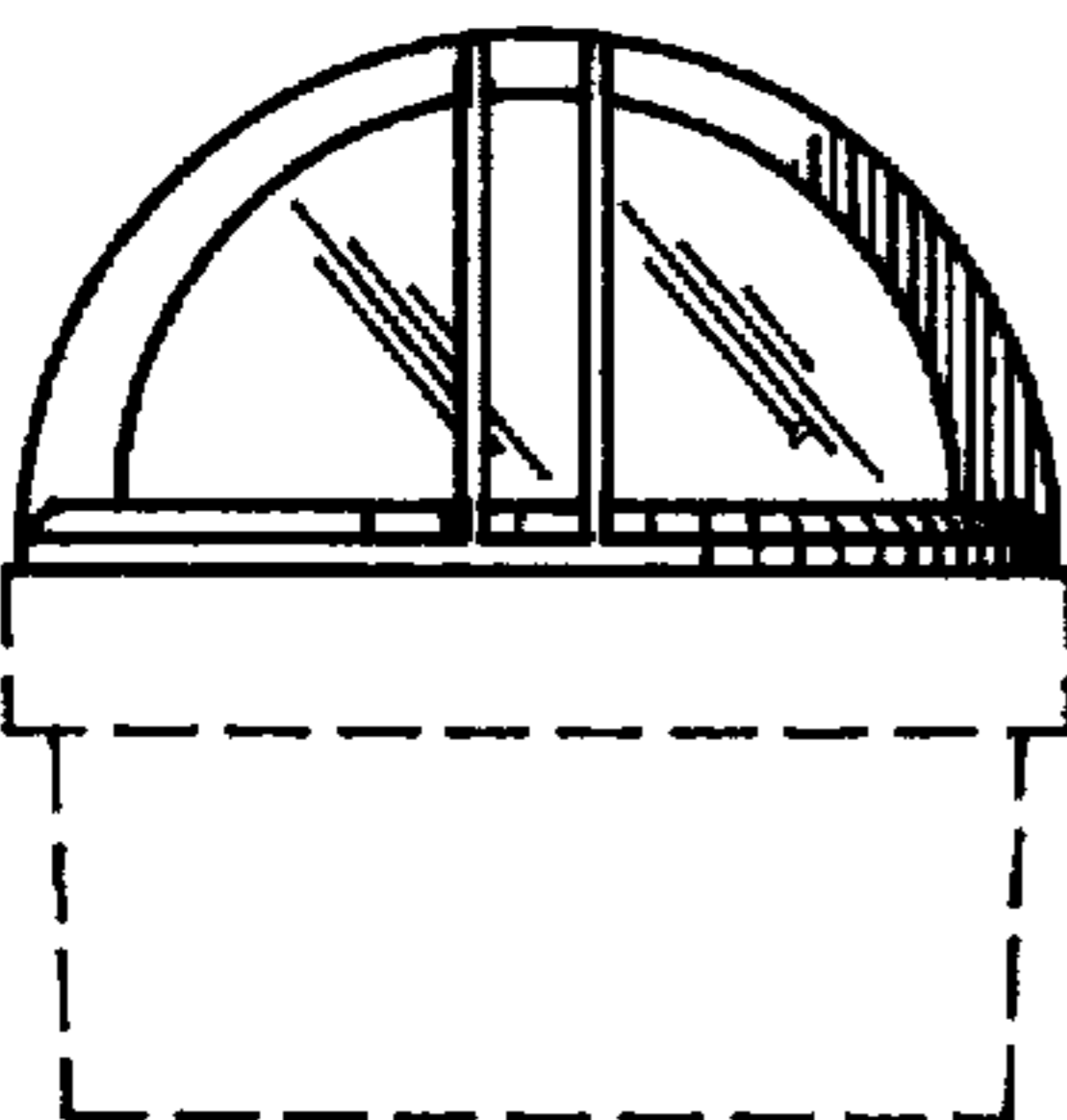

FIG. 11