

US00D384832S

United States Patent [19]

Senturia et al.

[11] Patent Number: **Des. 384,832**

[45] Date of Patent: ****Oct. 14, 1997**

[54] **WALL MOUNTED COMPUTER STATION**

[75] Inventors: **Neil R. Senturia, La Jolla; Dennis T. Rogers, San Diego, both of Calif.**

[73] Assignee: **Senturia Investments, Inc., San Diego, Calif.**

[**] Term: **14 Years**

[21] Appl. No.: **54,622**

[22] Filed: **May 17, 1996**

[51] **LOC (6) CL. 06-04**

[52] **U.S. Cl. D6/397; D6/421; D6/425**

[58] **Field of Search D6/396, 397, 422-428, D6/335, 336, 338; 312/194-196, 223.2, 223.3**

[56] **References Cited**

U.S. PATENT DOCUMENTS

- D. 119,253 3/1940 Balleydier D6/338
- D. 150,679 8/1948 Cunningham D6/338
- D. 169,012 3/1953 Musacco D6/338

- D. 179,806 3/1957 Lord D6/338
- D. 216,724 3/1970 Sherman D6/420 X
- D. 306,238 2/1990 Pham-Phu D6/397
- D. 322,178 12/1991 Pons D6/338
- D. 330,467 10/1992 Pons et al. D6/397
- D. 348,569 7/1994 Haussmann D6/338

Primary Examiner—Carmen H. Vales-Lado
Attorney, Agent, or Firm—Baker, Maxham, Jester & Meador

[57] **CLAIM**

The ornamental design for a wall mounted computer station, as shown and described.

DESCRIPTION

FIG. 1 is a perspective view of a wall mounted computer station showing our new design;
FIG. 2 is a front elevational view thereof;
FIG. 3 is a right side elevational view thereof;
FIG. 4 is a rear elevational view thereof;
FIG. 5 is a left side elevational view thereof;
FIG. 6 is a top plan view thereof; and,
FIG. 7 is a bottom plan view thereof.

1 Claim, 6 Drawing Sheets

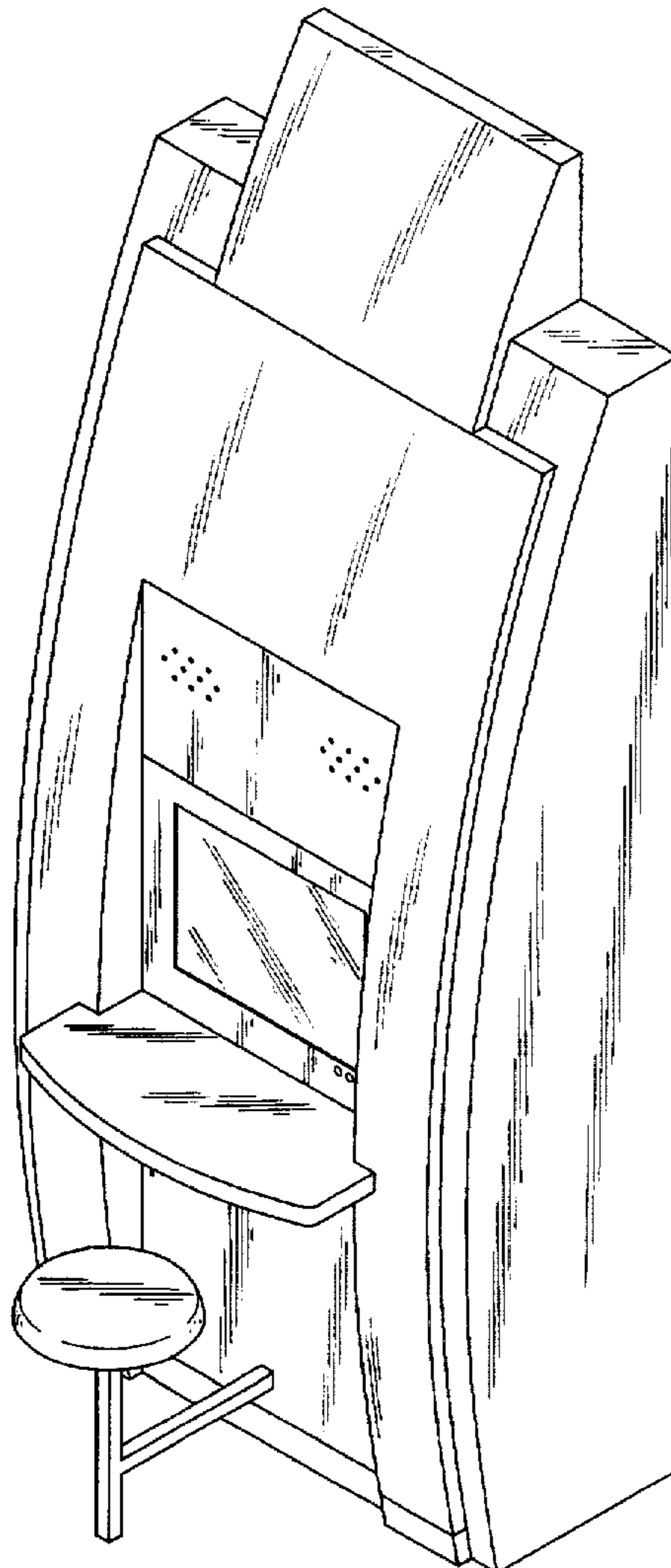

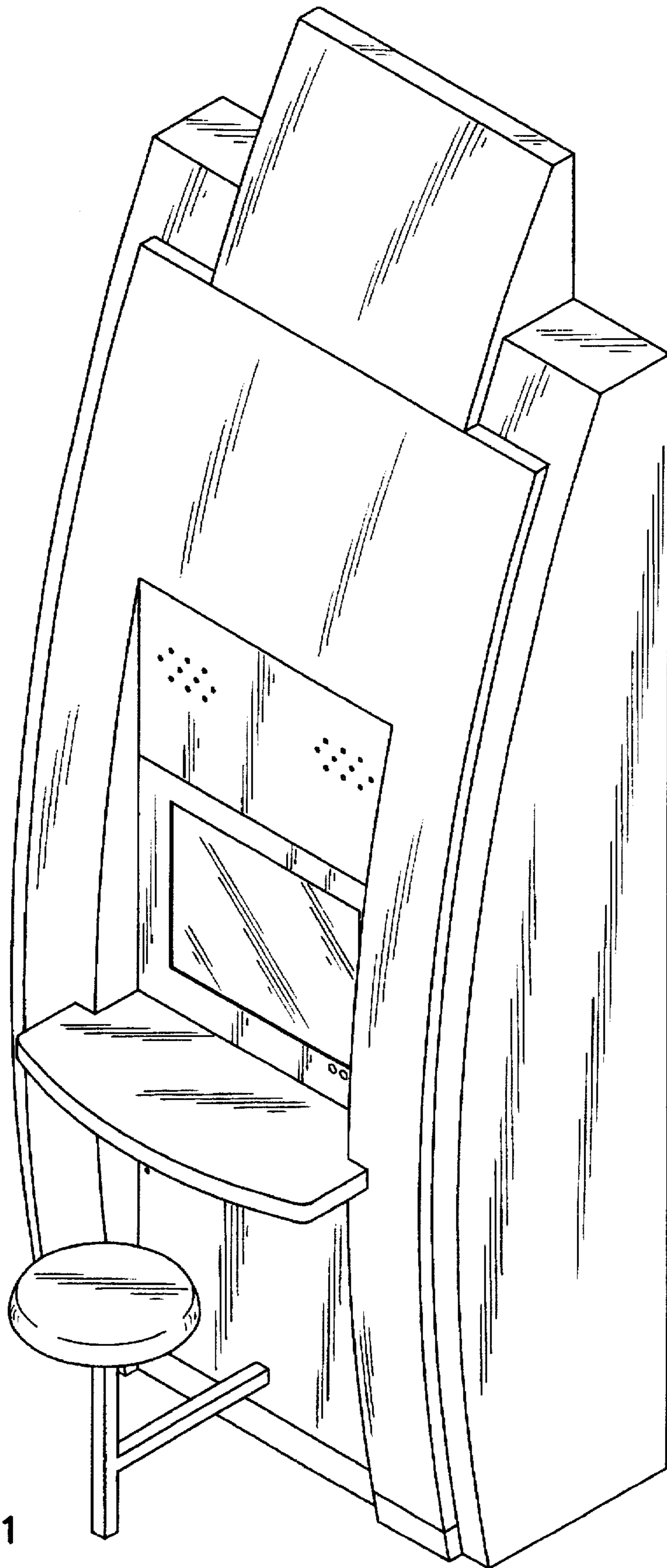

FIG. 1

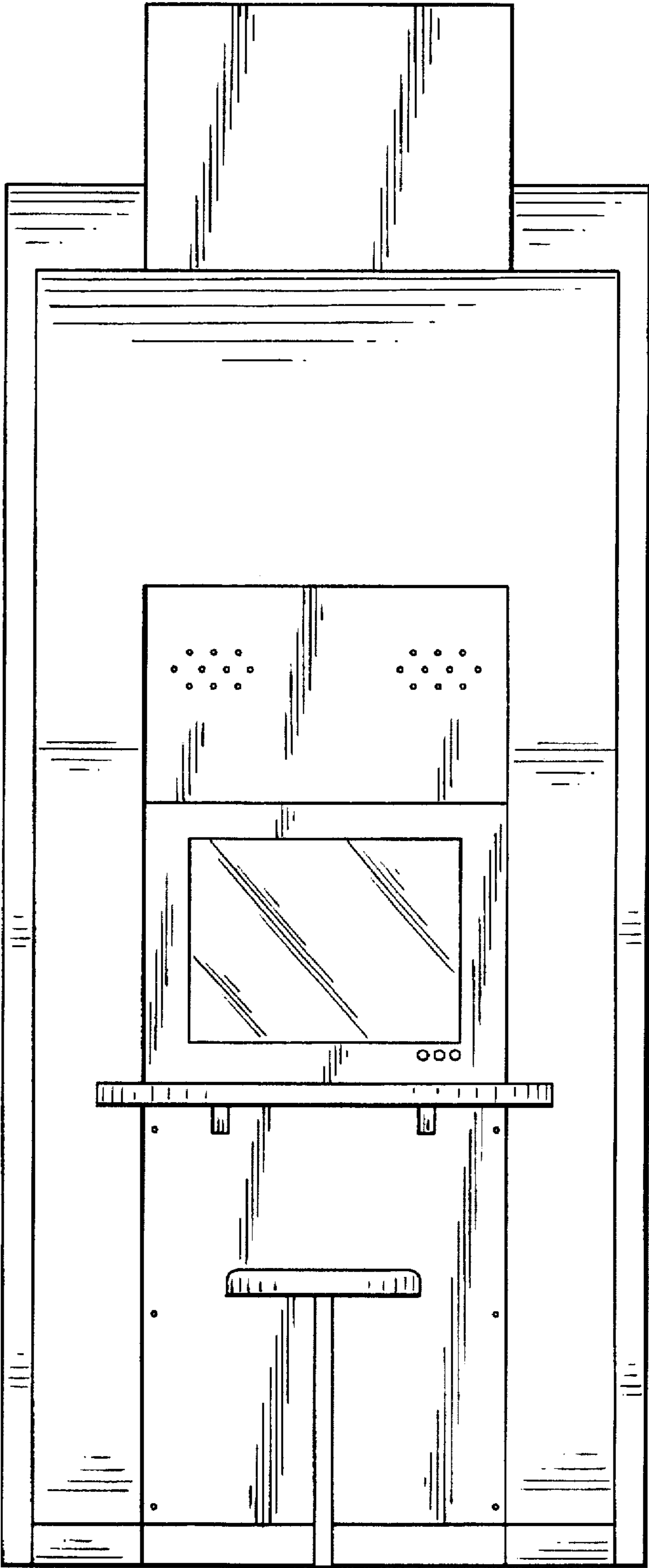

FIG. 2

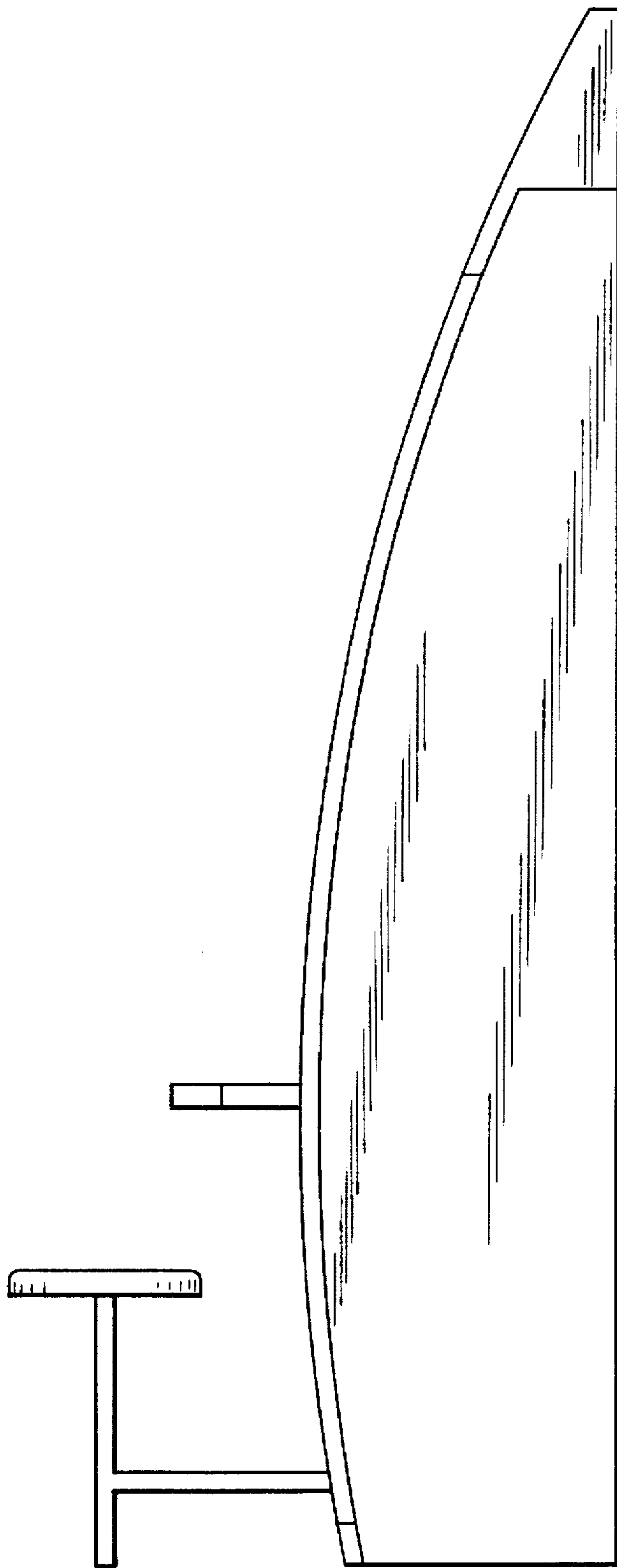

FIG. 3

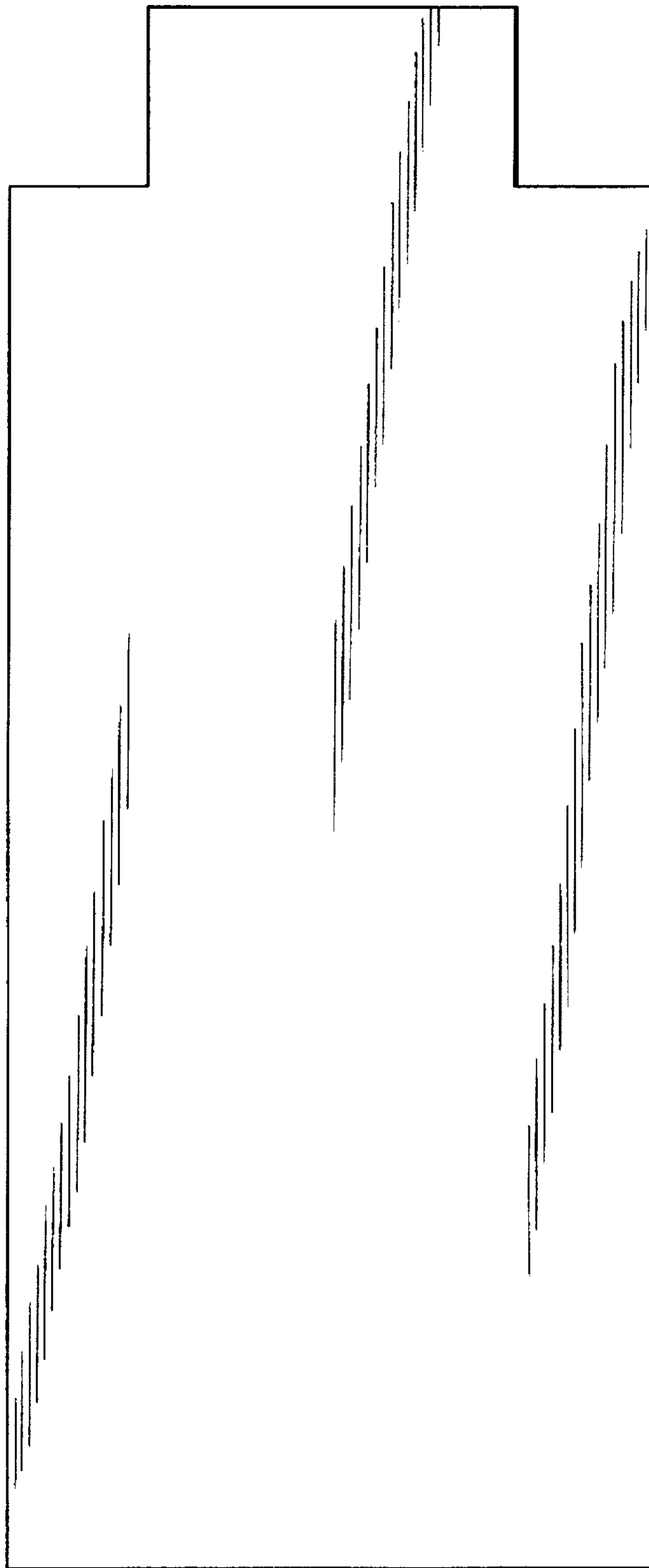

FIG. 4

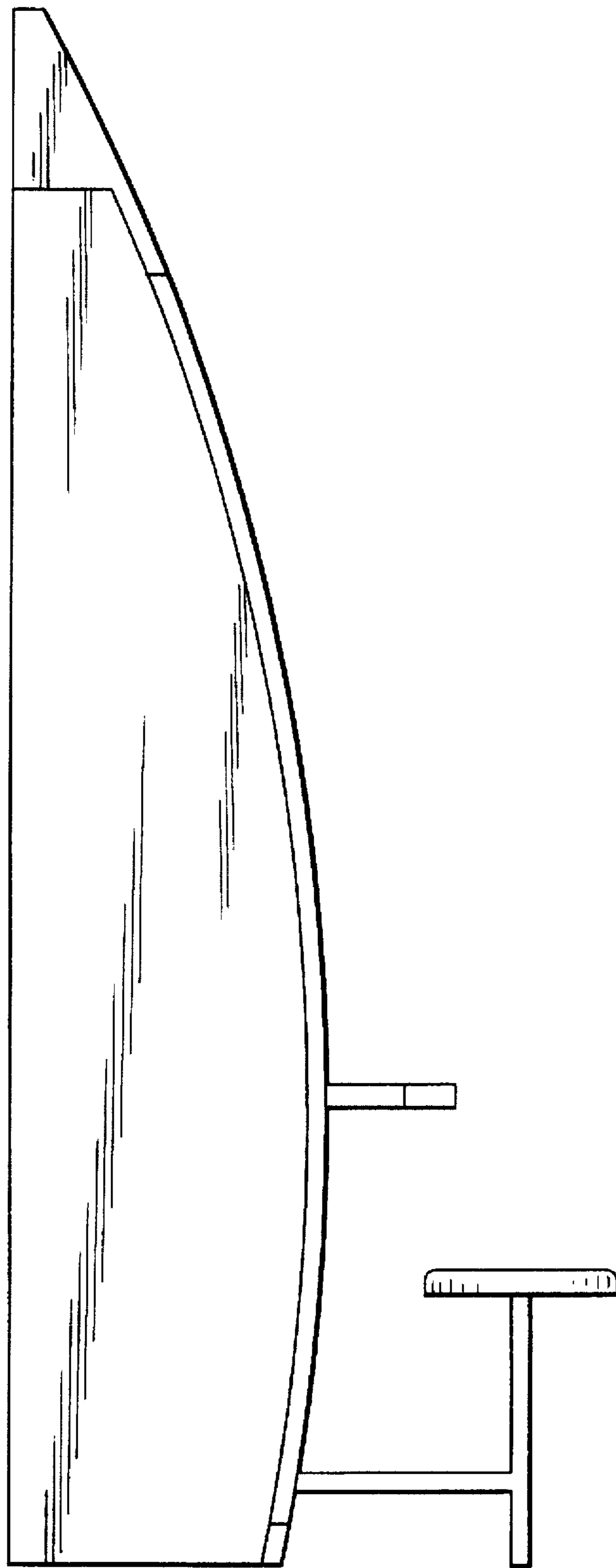

FIG. 5

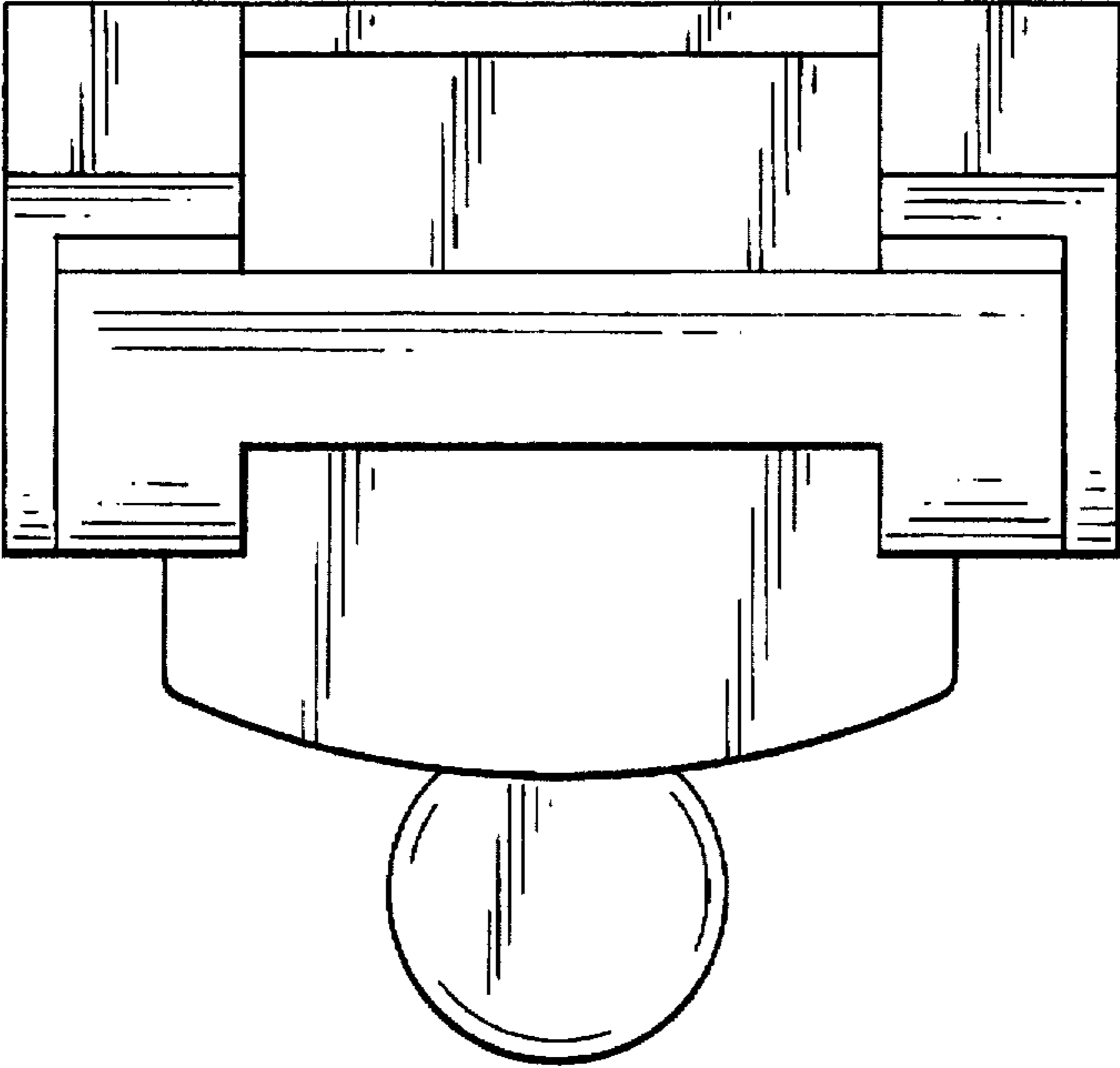

FIG. 6

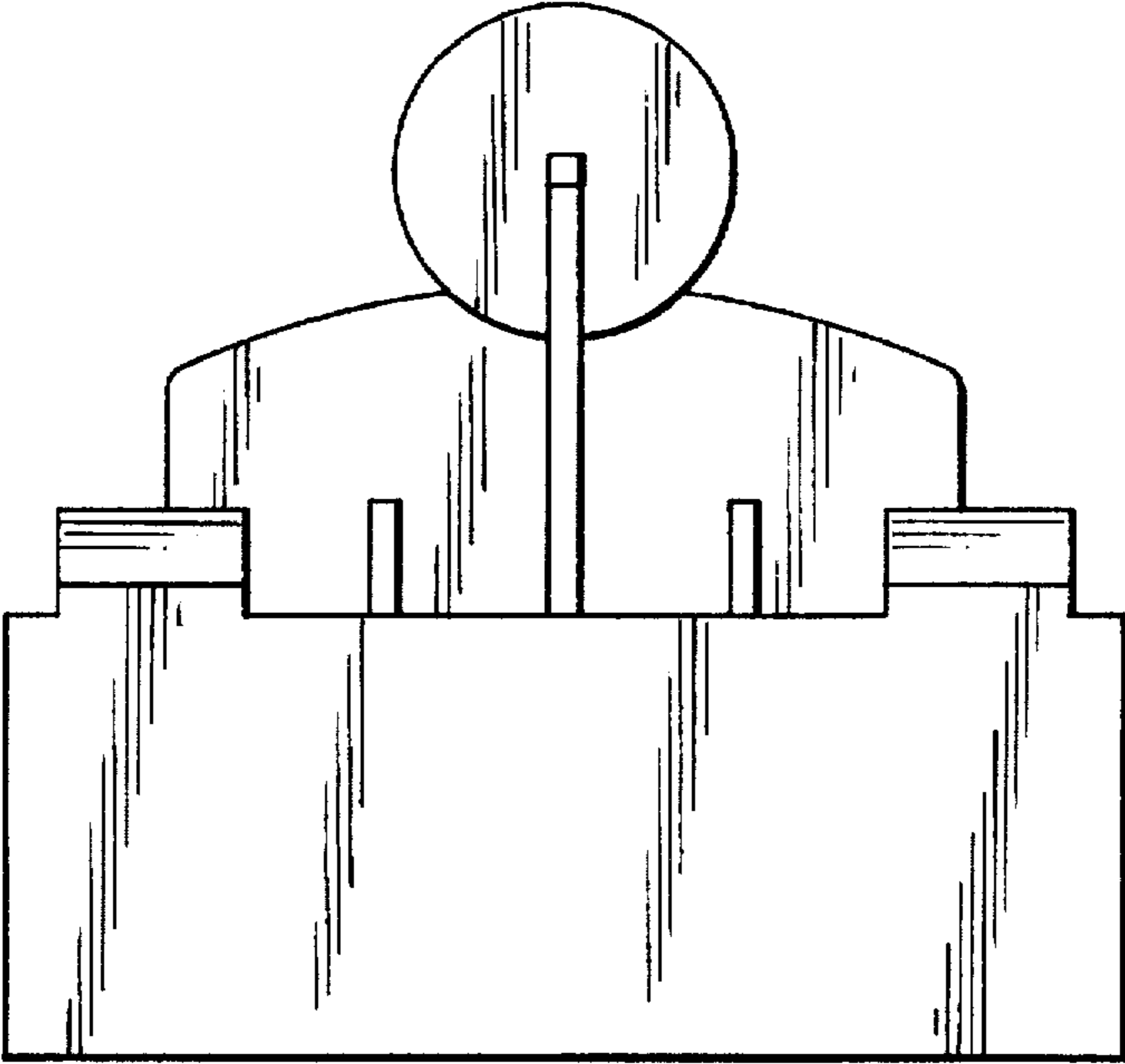

FIG. 7