



US00D384818S

**United States Patent** [19]  
**Wolfenden**

[11] **Patent Number: Des. 384,818**  
[45] **Date of Patent: \*\*Oct. 14, 1997**

[54] **BROOM HEAD**

[75] **Inventor: Anthony Henry Wolfenden, Elwood, Australia**

[73] **Assignee: The Decor Corporation Pty Ltd, Victoria, Australia**

[\*\*] **Term: 14 Years**

[21] **Appl. No.: 44,084**

[22] **Filed: Sep. 18, 1995**

[51] **LOC (6) Cl. .... 04-99**

[52] **U.S. Cl. .... D4/199; D32/50**

[58] **Field of Search .... D4/130, 132, 135, D4/138, 199; D32/40, 50, 51; 15/143.1, 146, 159.1, 160, 176.1, 176.2, 186, 187**

[56] **References Cited**

**U.S. PATENT DOCUMENTS**

D. 195,818	8/1963	Herman et al. ....	D32/50
D. 232,617	9/1974	Albrecht .....	D32/50
D. 287,173	12/1986	Libman .....	D32/51
3,076,217	2/1963	Scholl .....	15/176.2 X
4,384,383	5/1983	Bryant .....	15/176.2 X

**OTHER PUBLICATIONS**

Sunshine Catalogue, 1994; Brooms, pp. 4 & 12.  
L.A. Brush, Catalog 200, Fountain Brush, Item No. 714, p. 48.

*Primary Examiner*—Brian N. Vinson  
*Assistant Examiner*—Lavone Tabor  
*Attorney, Agent, or Firm*—Lowe, Price, LeBlanc & Becker

[57] **CLAIM**

The ornamental design for a broom head, as shown and described.

**DESCRIPTION**

FIG. 1 is a perspective view from above and one side thereof;  
FIG. 2 is a perspective view from below and the other side thereof;  
FIG. 3 is a top view thereof;  
FIG. 4 is an end view from one side thereof;  
FIG. 5 is a side view thereof;  
FIG. 6 is an end view from the other side thereof;  
FIG. 7 is an underneath view thereof; and,  
FIG. 8 is a side view of the opposite side shown in FIG. 5 thereof.

**1 Claim, 2 Drawing Sheets**

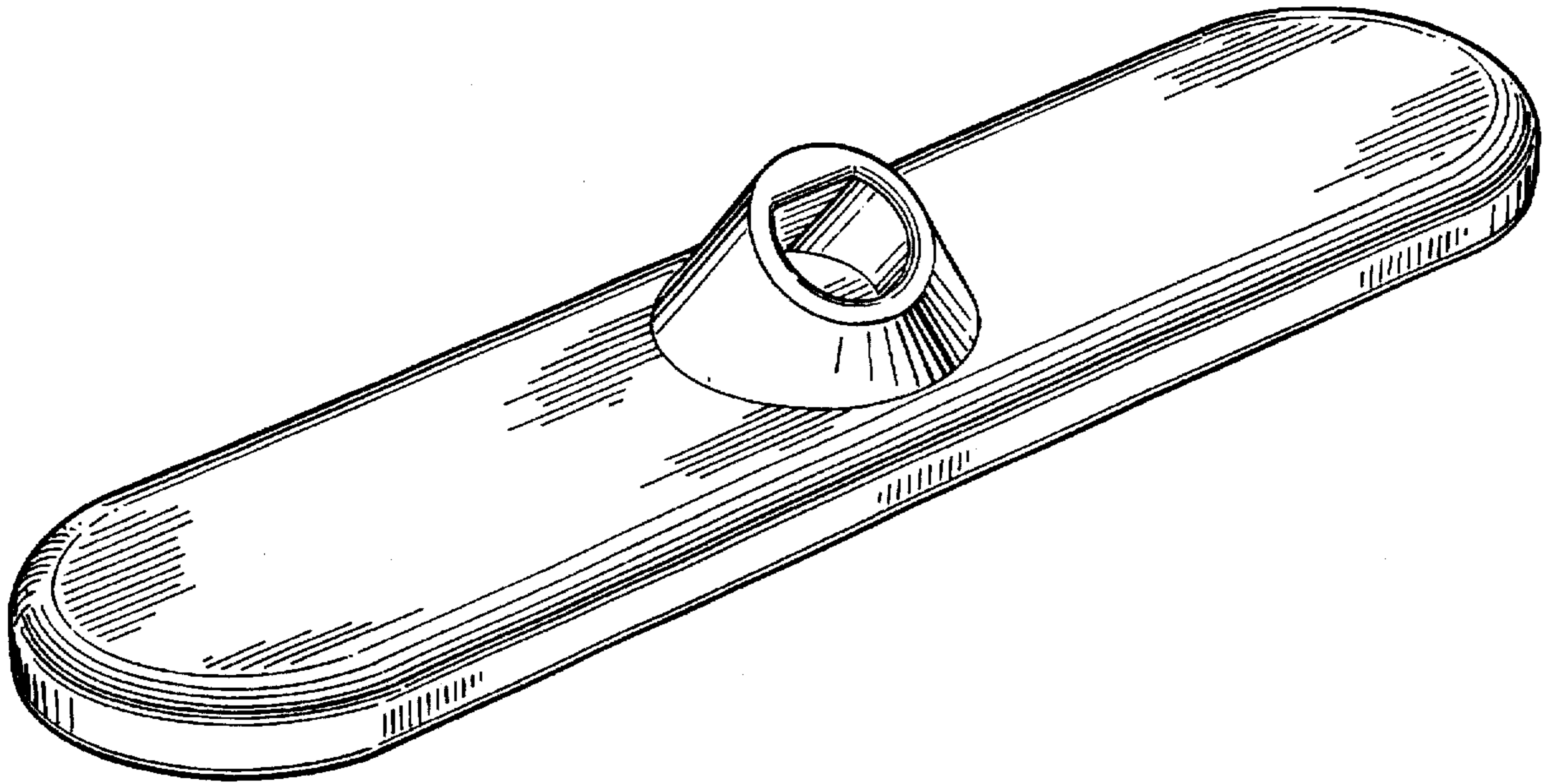

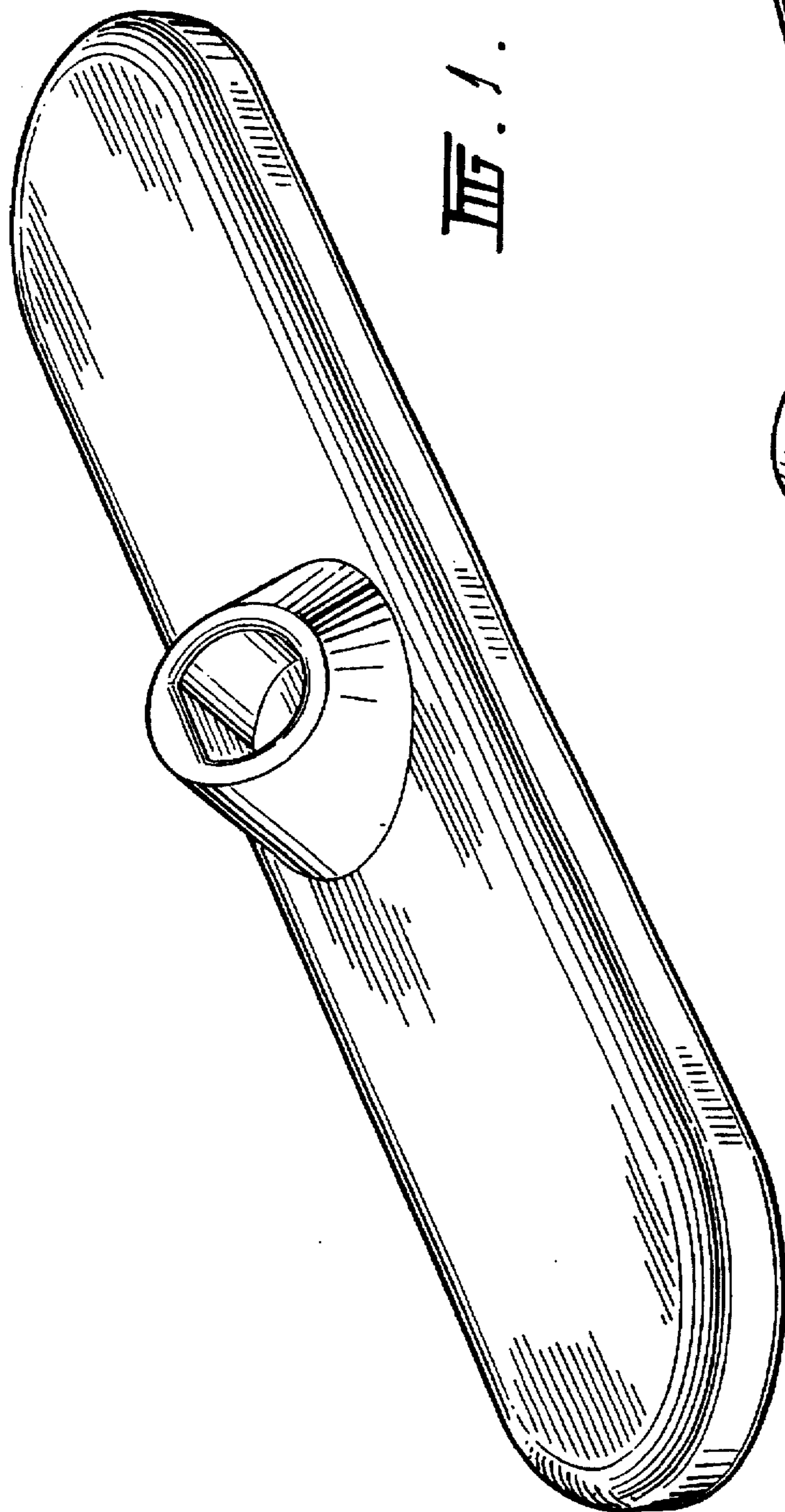

FIG. 1.

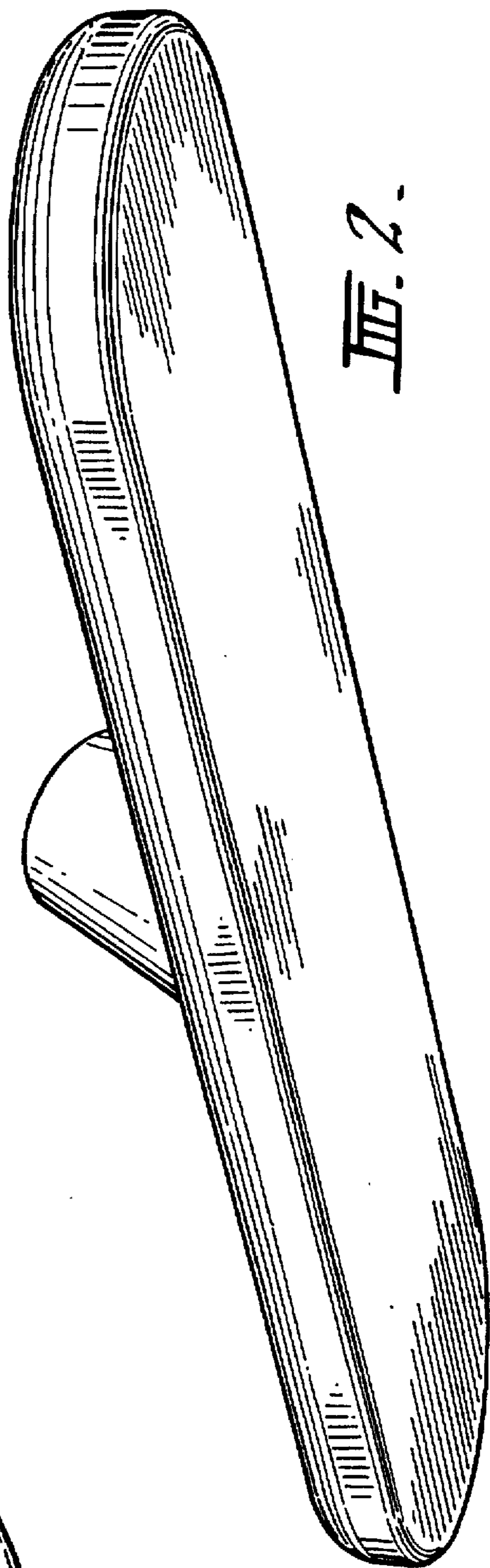

FIG. 2.

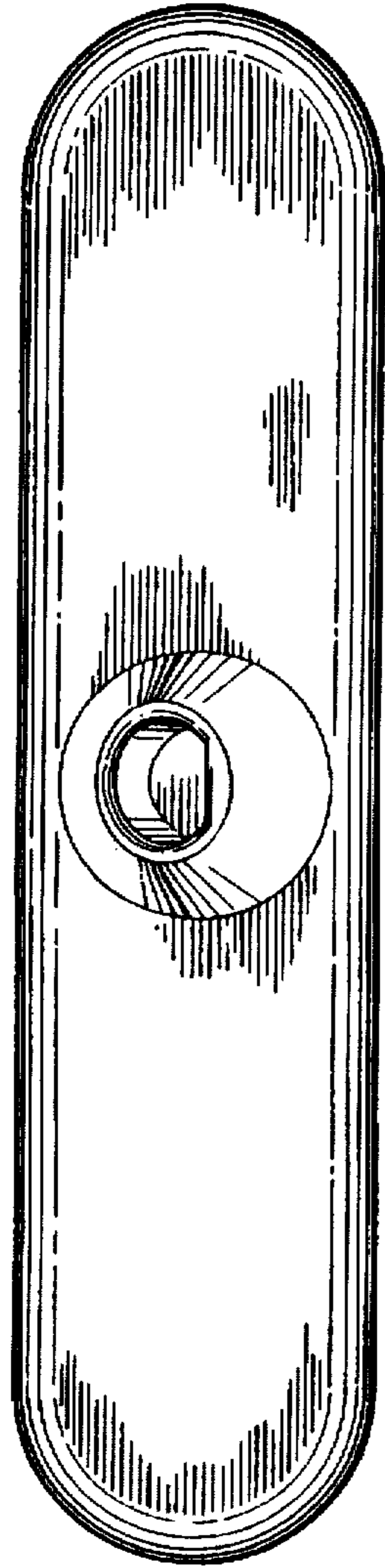

FIG. 3.

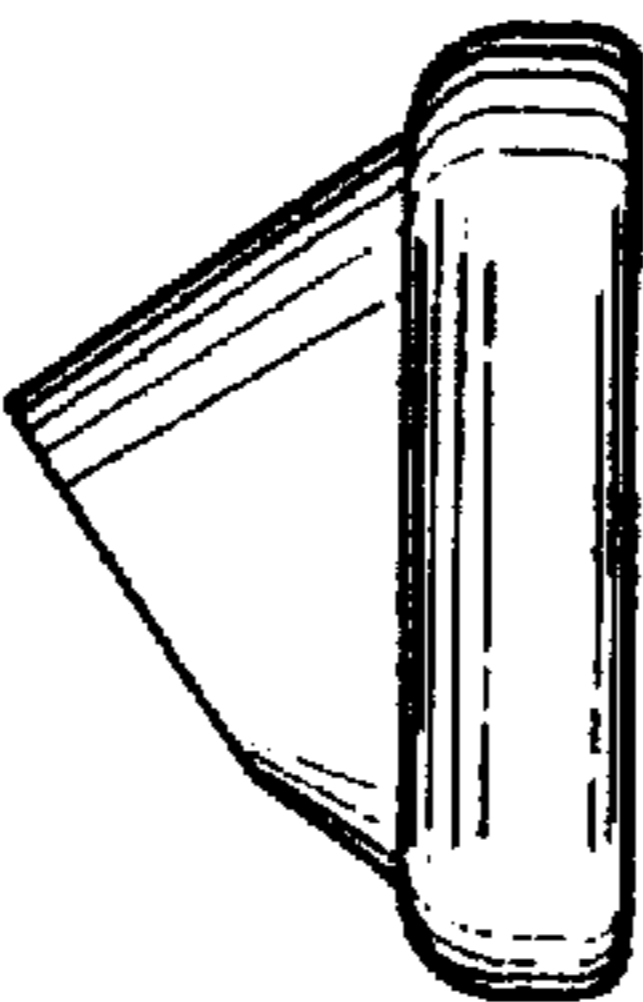

FIG. 4.

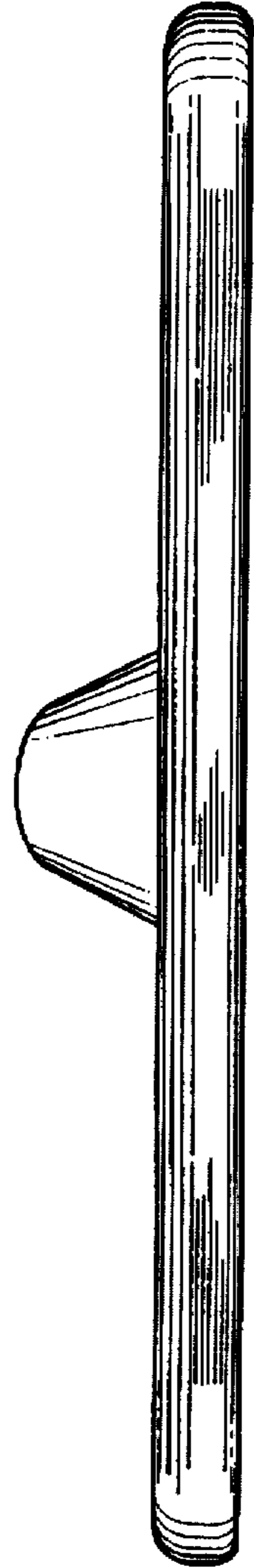

FIG. 5.

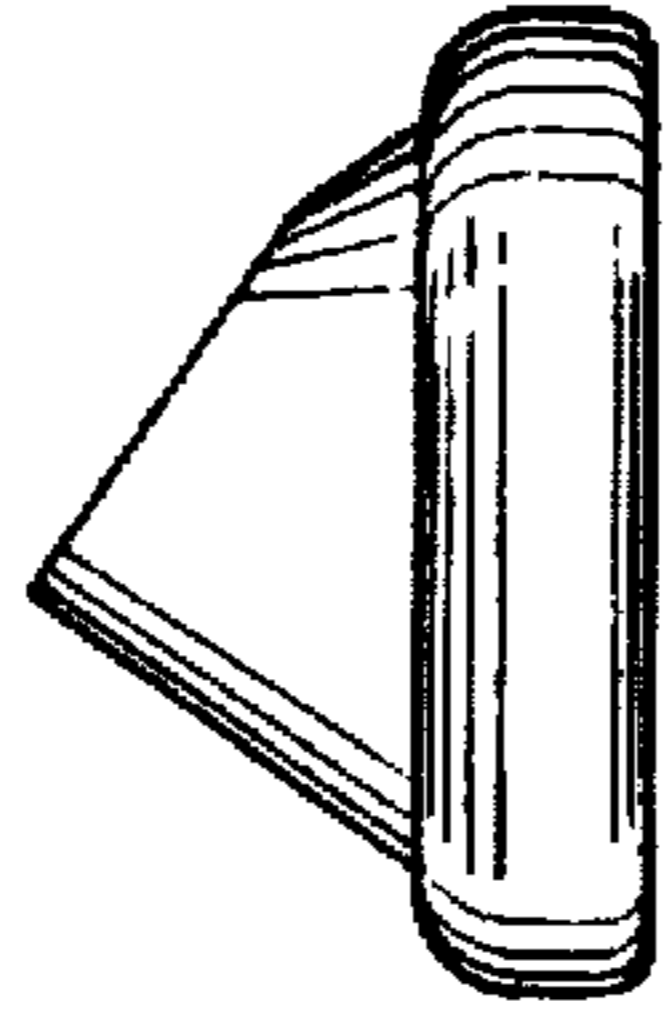

FIG. 6.

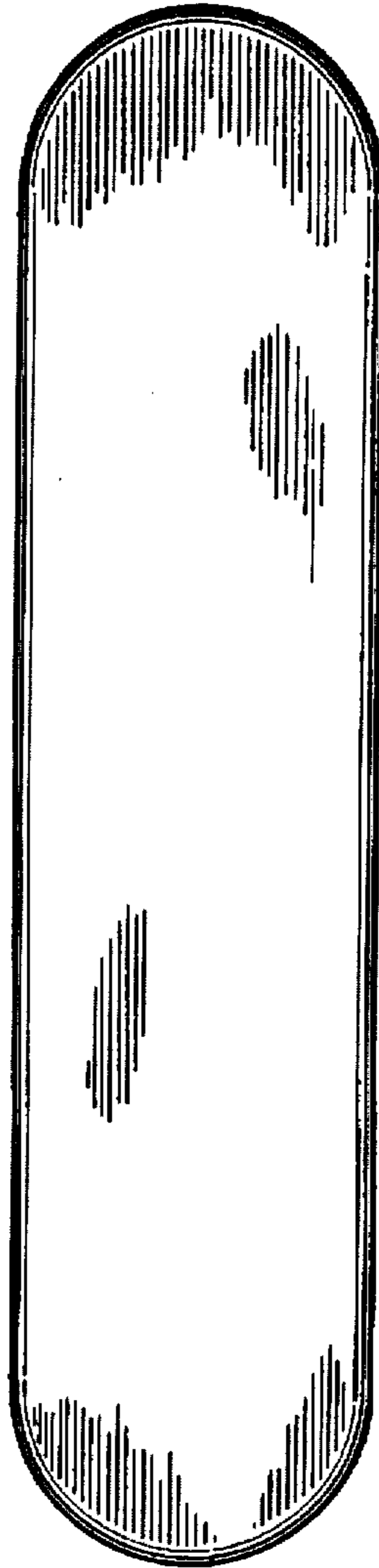

FIG. 7.

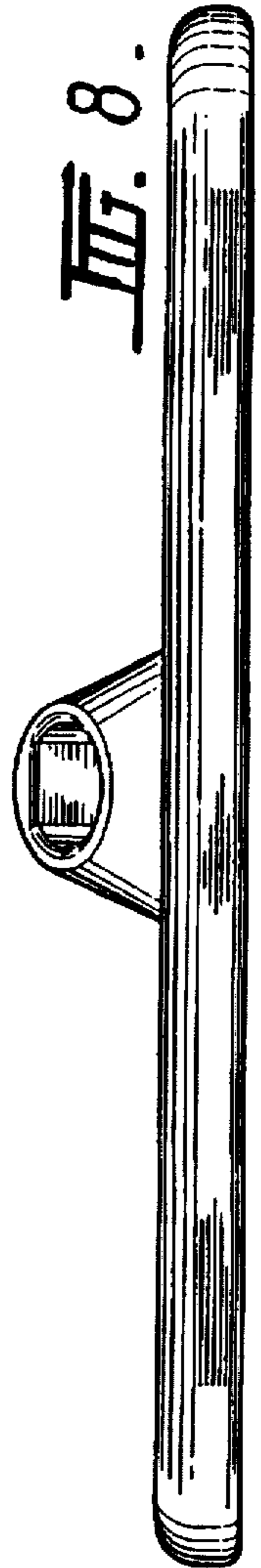

FIG. 8.