



US00D384811S

# United States Patent [19]

Whiteman et al.

[11] Patent Number: **Des. 384,811**

[45] Date of Patent: **\*\*Oct. 14, 1997**

[54] **BIG GAME TRACKER**

4,937,431 6/1990 Jameson et al. .... D22/125 X

5,060,411 10/1991 Uhlman ..... 43/1

5,392,975 2/1995 Blankenship, Jr. .... 224/148 X

[76] Inventors: **Christopher T. Whiteman**, 212 Carlyn Ct.; **Dave Ruble**, 7 Lynn Blvd., both of Downingtown, Pa. 19335

*Primary Examiner*—Louis S. Zarfes

*Assistant Examiner*—Catherine R. Oliver

[\*\*] Term: **14 Years**

## [57] CLAIM

[21] Appl. No.: **41,463**

The ornamental design for an big game tracker, as shown and described.

[22] Filed: **Jul. 14, 1995**

## DESCRIPTION

[51] LOC (6) Cl. .... **03-01**

[52] U.S. Cl. .... **D3/229; D3/221; D22/125**

[58] **Field of Search** ..... D3/229, 262; 224/148, 224/196, 228, 236, 240, 242, 250, 246, 253, 268, 914; 43/1; D22/125

FIG. 1 is a front elevational view of big game tracker our new design;

FIG. 2 is a rear elevational view thereof;

FIG. 3 is a left side elevational view thereof;

FIG. 4 is a right side elevational view thereof;

FIG. 5 is a top elevational view thereof;

FIG. 6 is a bottom elevational view thereof; and,

FIG. 7 is an isometric view of our new design.

## [56] References Cited

### U.S. PATENT DOCUMENTS

D. 301,912 6/1989 Ward ..... D22/125

3,119,650 1/1964 Bilyeu ..... D22/125 X

**1 Claim, 4 Drawing Sheets**

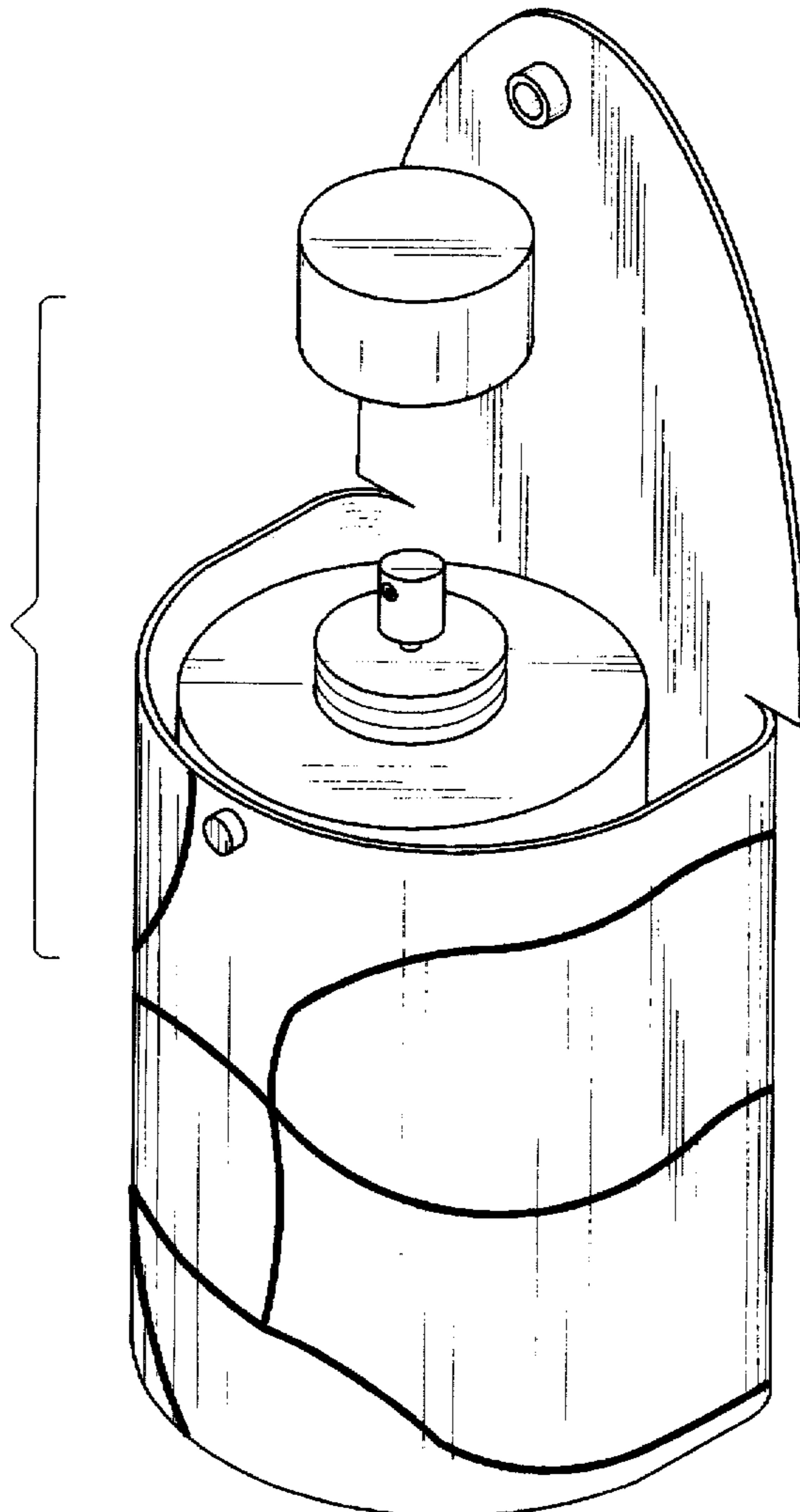

FIG. 1

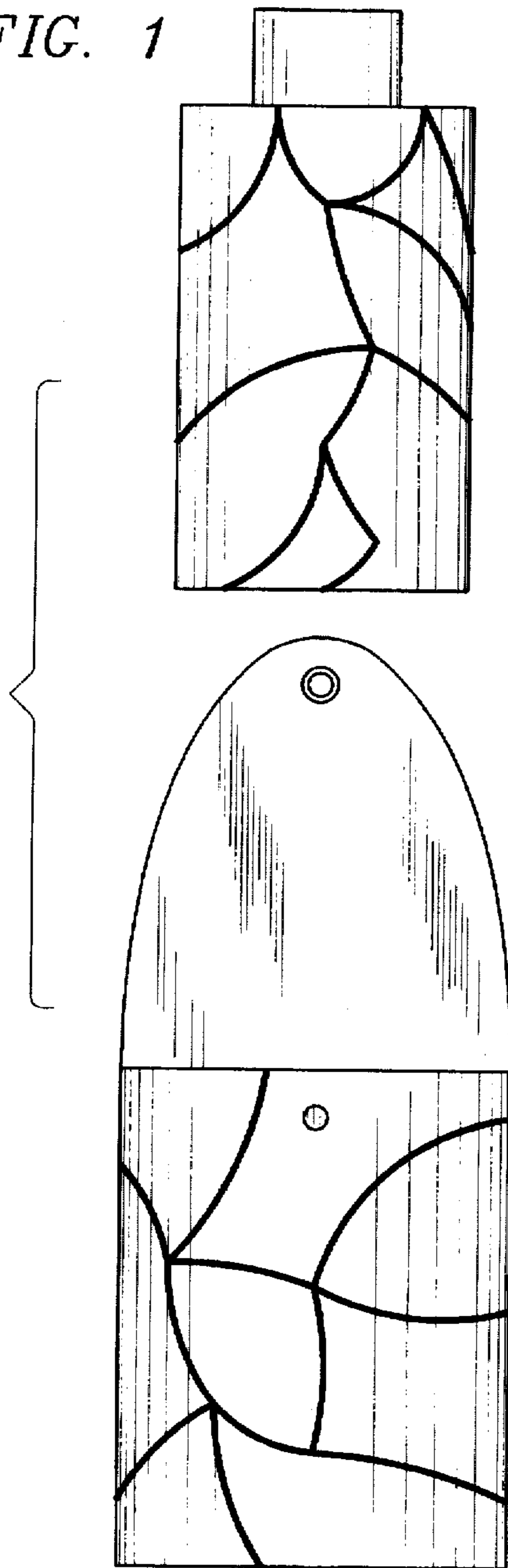

FIG. 2

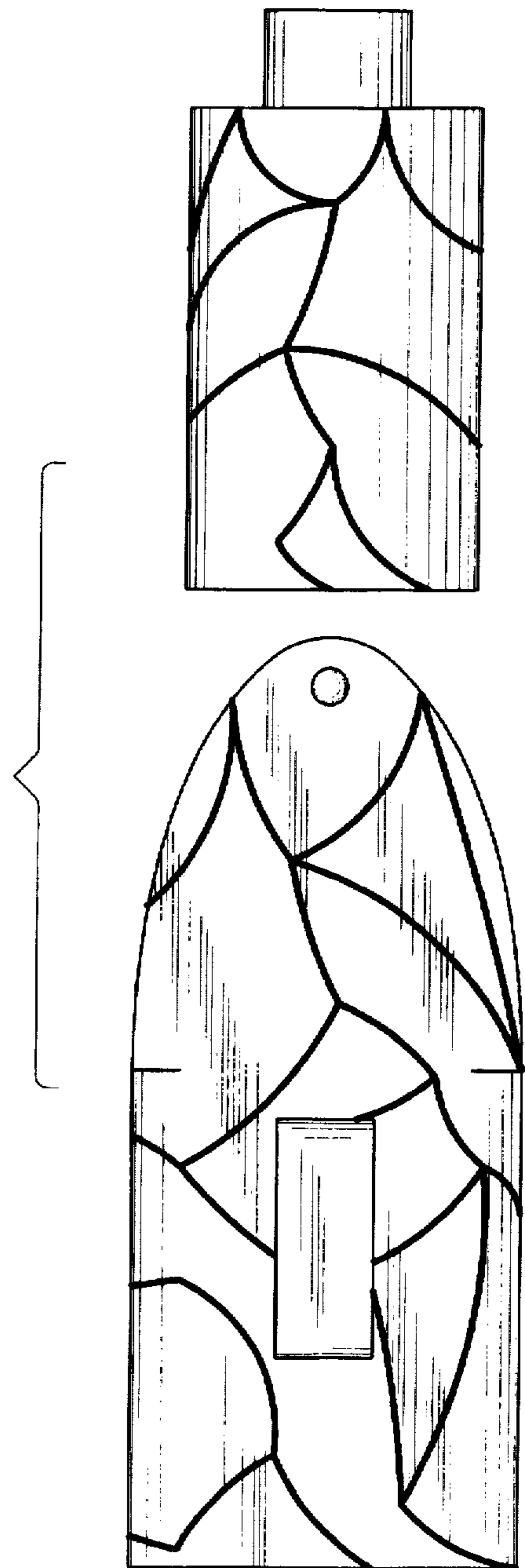

FIG. 3

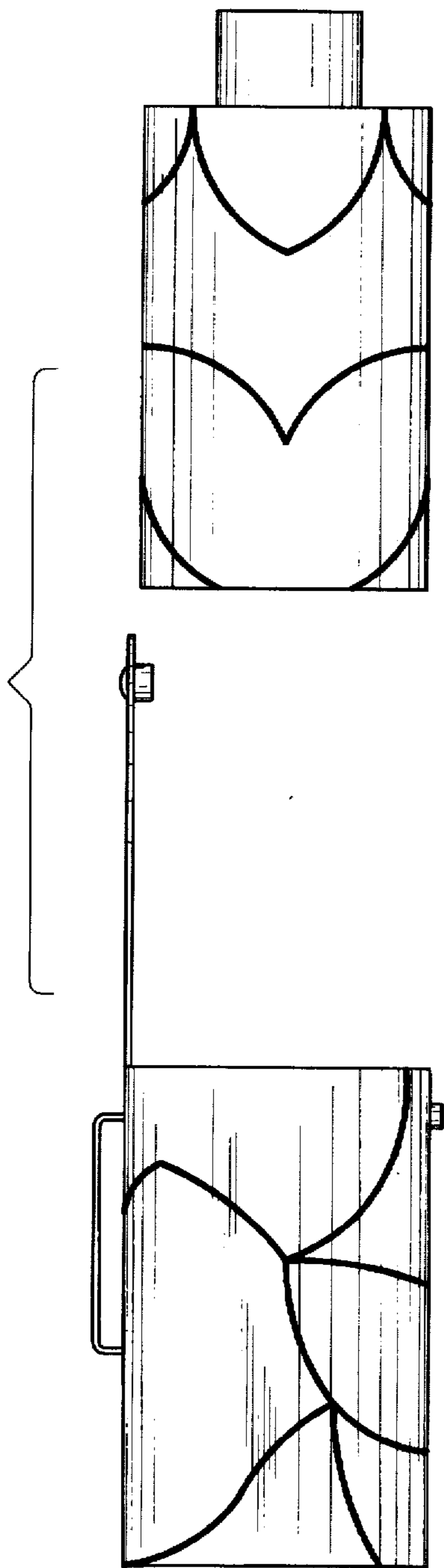
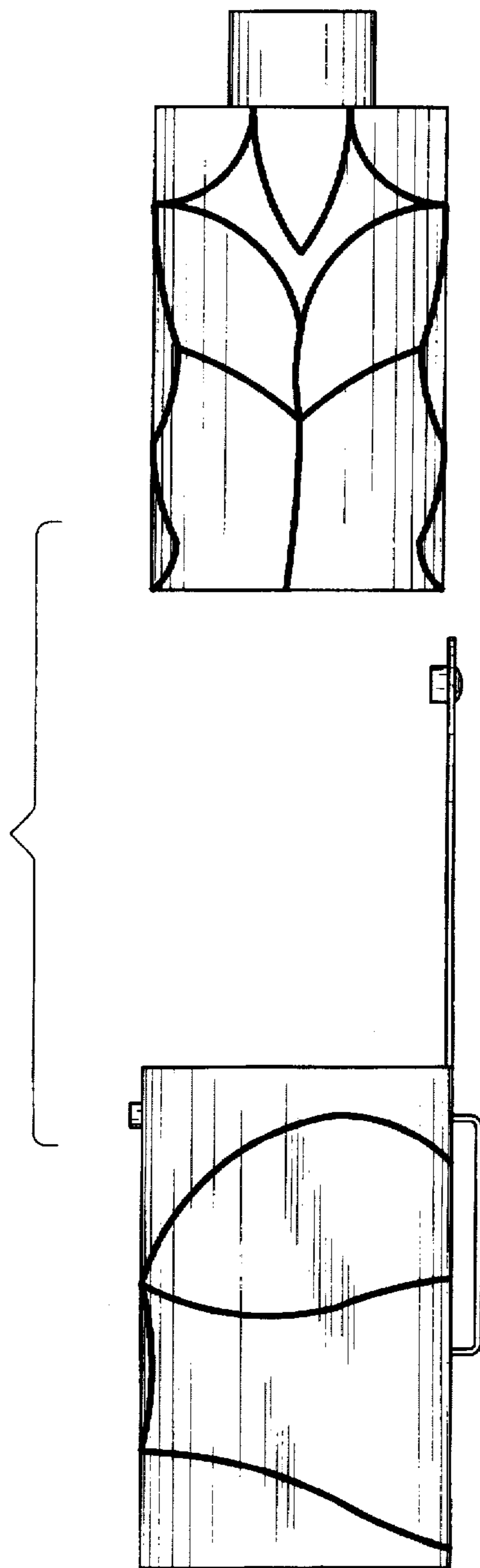
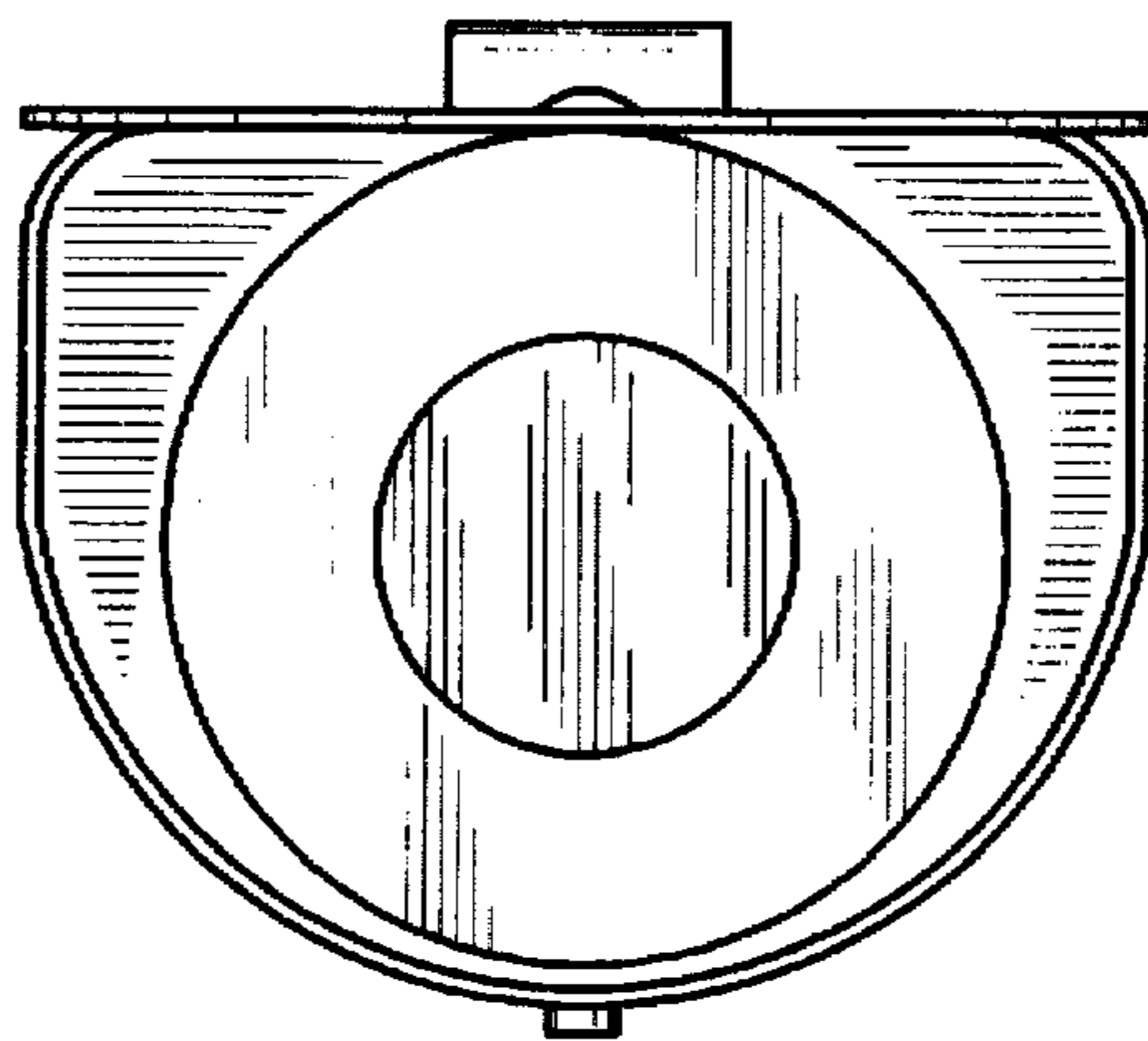

FIG. 4



*FIG. 5*



*FIG. 6*

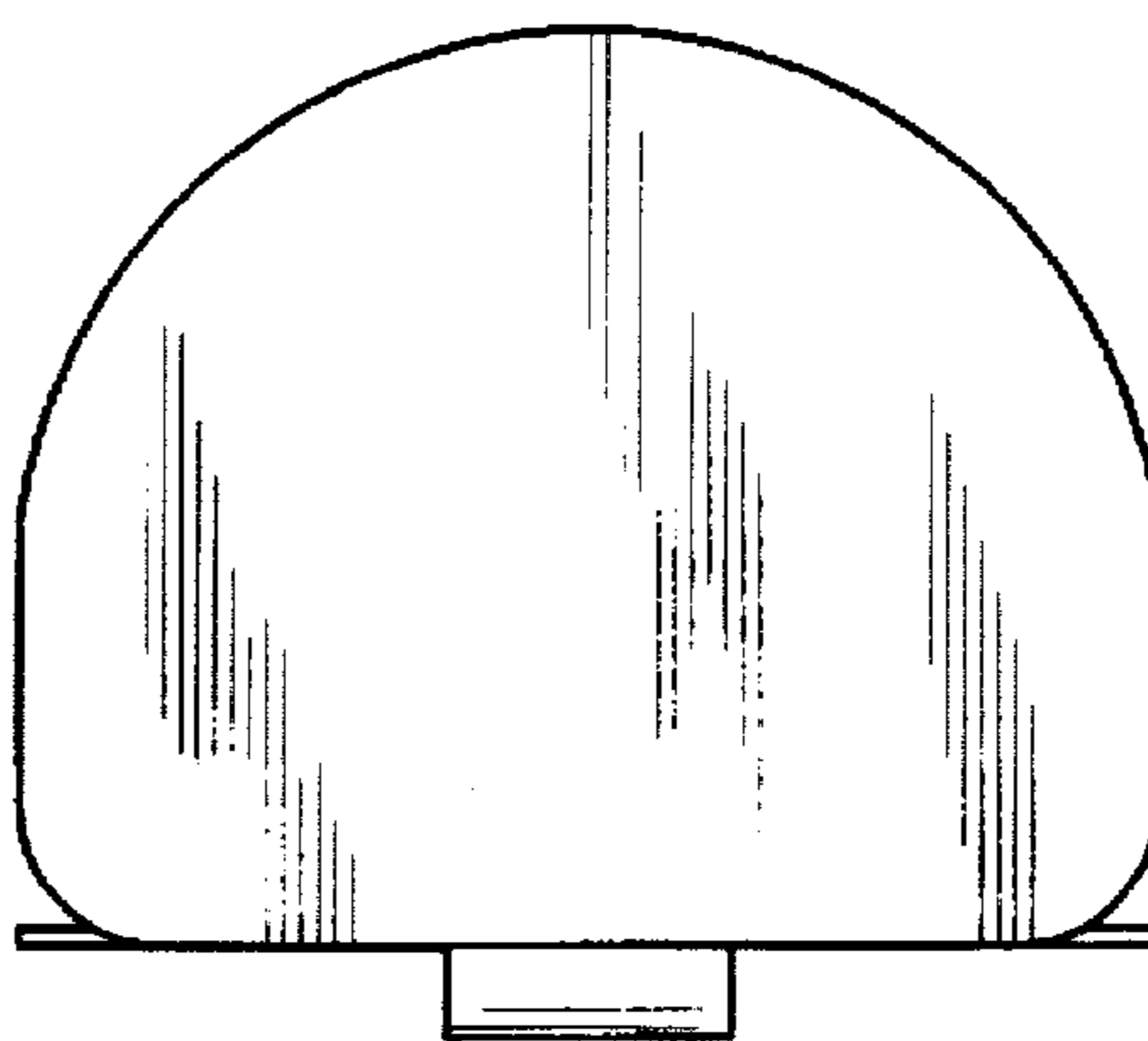

FIG. 7

