

US00D384714S

United States Patent [19]
Bradley

[11] **Patent Number:** **Des. 384,714**
[45] **Date of Patent:** ****Oct. 7, 1997**

[54] **BALL RETURN ATTACHMENT FOR BASKETBALL HOOP**

[76] **Inventor:** **Brian D. Bradley**, 5144 N. 69th Pl., Scottsdale, Ariz. 85253

[**] **Term:** **14 Years**

[21] **Appl. No.:** **50,814**

[22] **Filed:** **Feb. 27, 1996**

[51] **LOC (6) Cl.** **21-99**

[52] **U.S. Cl.** **D21/201**

[58] **Field of Search** **D21/201, 200; 273/1.5 R, 1.5 A, 395, 396, 397**

[56] **References Cited**

U.S. PATENT DOCUMENTS

D. 271,508	11/1983	McGregor	D21/201
D. 308,237	5/1990	McCullough	D21/201
D. 351,880	10/1994	Taylor et al.	D21/201
3,814,421	6/1974	Spier, Jr.	273/396 X
5,098,090	3/1992	Juhl	273/1.5 A
5,348,290	9/1994	Matherne et al.	273/1.5 A
5,354,048	10/1994	Winesberry, Jr.	273/1.5 A
5,409,211	4/1995	Adamek	273/1.5 A
5,443,258	8/1995	Kinsella	273/1.5 A

Primary Examiner—Sandra L. Morris
Assistant Examiner—Cheri Cohen
Attorney, Agent, or Firm—Parsons & Goltry; Robert A. Parsons; Michael W. Goltry

[57] **CLAIM**

The ornamental design for a ball return attachment for basketball hoop, as shown and described.

DESCRIPTION

FIG. 1 is a perspective view of a ball return attachment for basketball hoop showing my new design therefor;
FIG. 2 is a top plan view;
FIG. 3 is a right side elevational view;
FIG. 4 is a rear elevational view;
FIG. 5 is a front elevational view;
FIG. 6 is a left side elevational view;
FIG. 7 is a bottom plan view;
FIG. 8 is a perspective view of a second alternate embodiment;
FIG. 9 is a top plan view;
FIG. 10 is a right side elevational view;
FIG. 11 is a rear elevational view;
FIG. 12 is a front elevational view;
FIG. 13 is a left side elevational view; and
FIG. 14 is a bottom plan view.

1 Claim, 2 Drawing Sheets

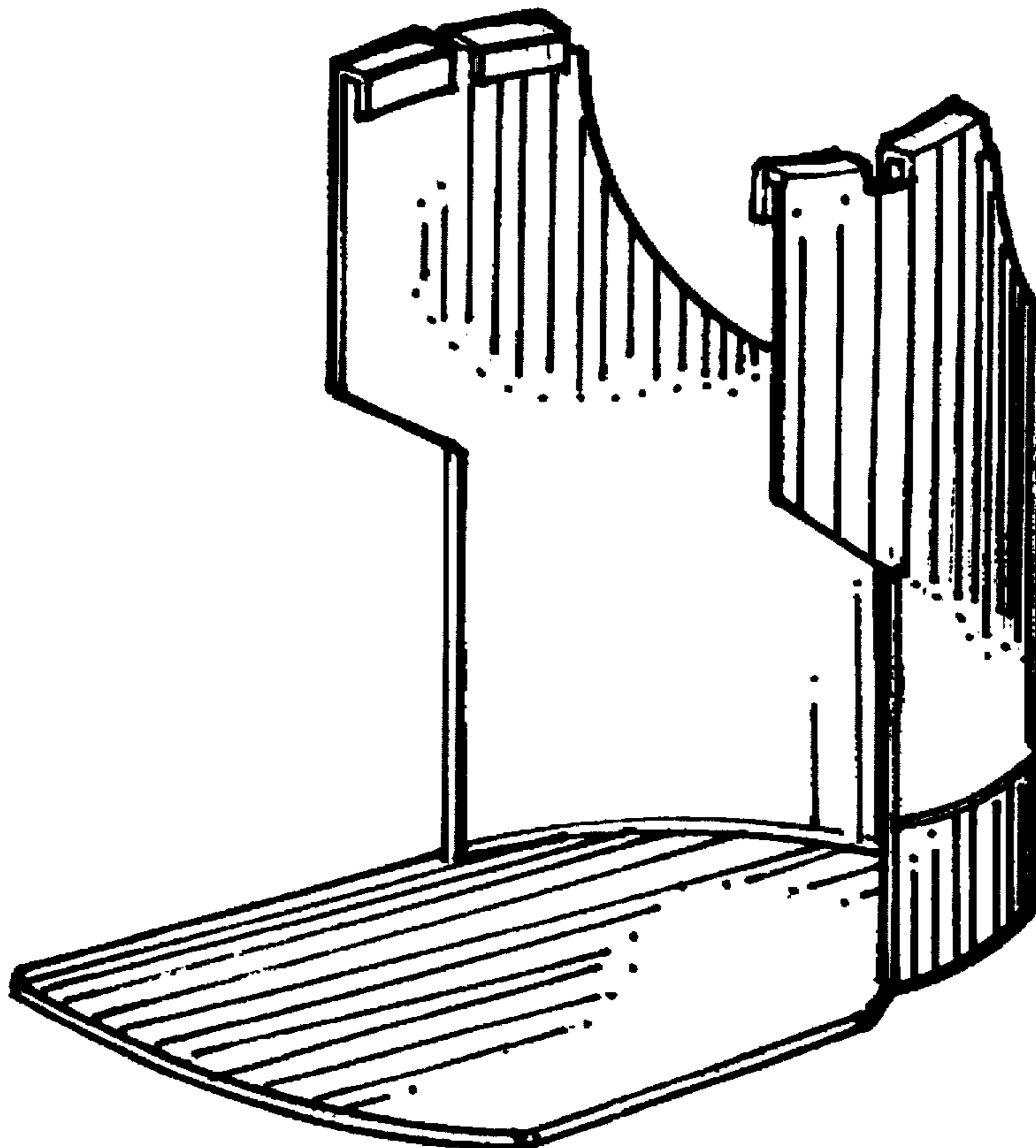

FIG. 2

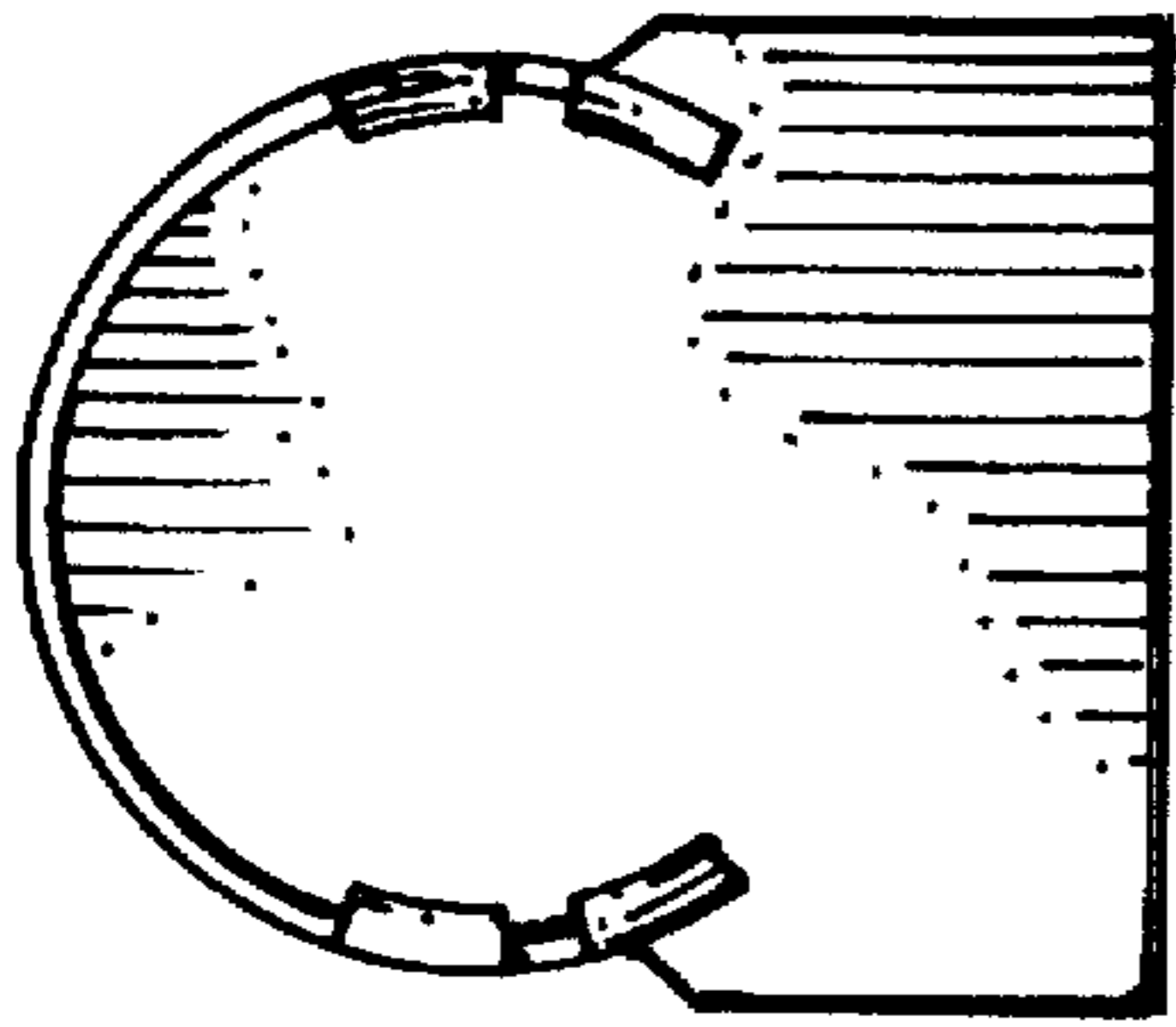

FIG. 1

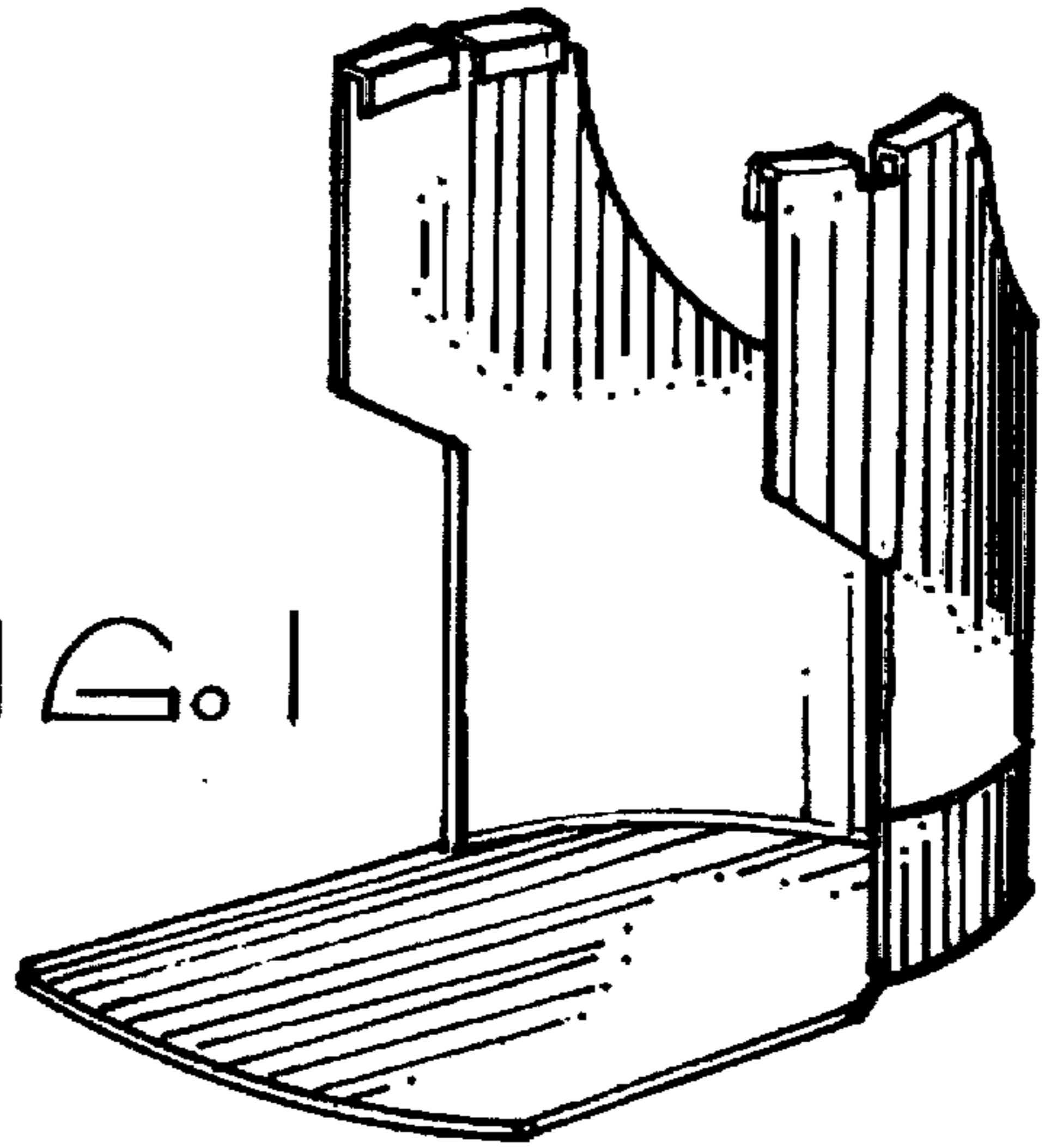

FIG. 3

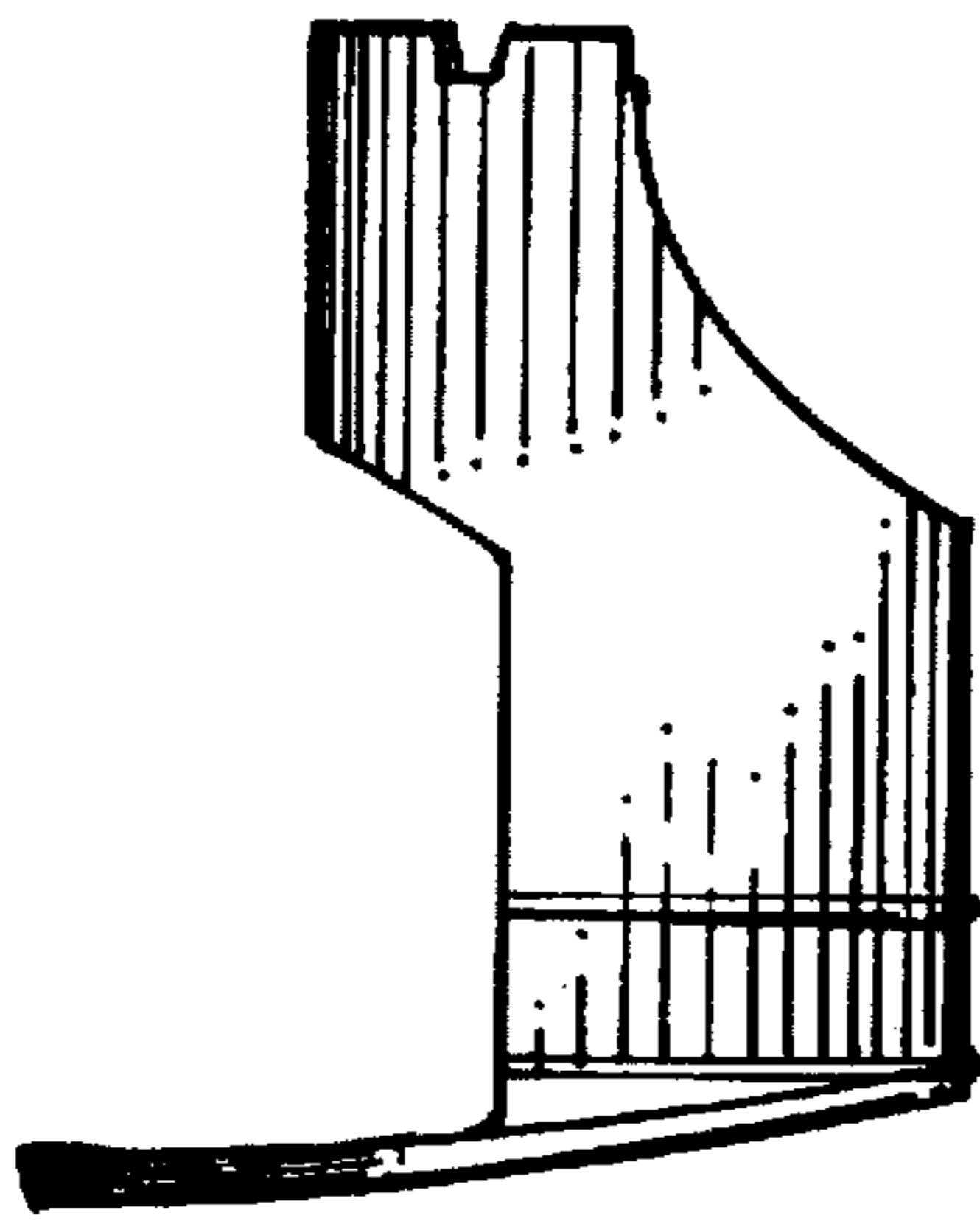

FIG. 4

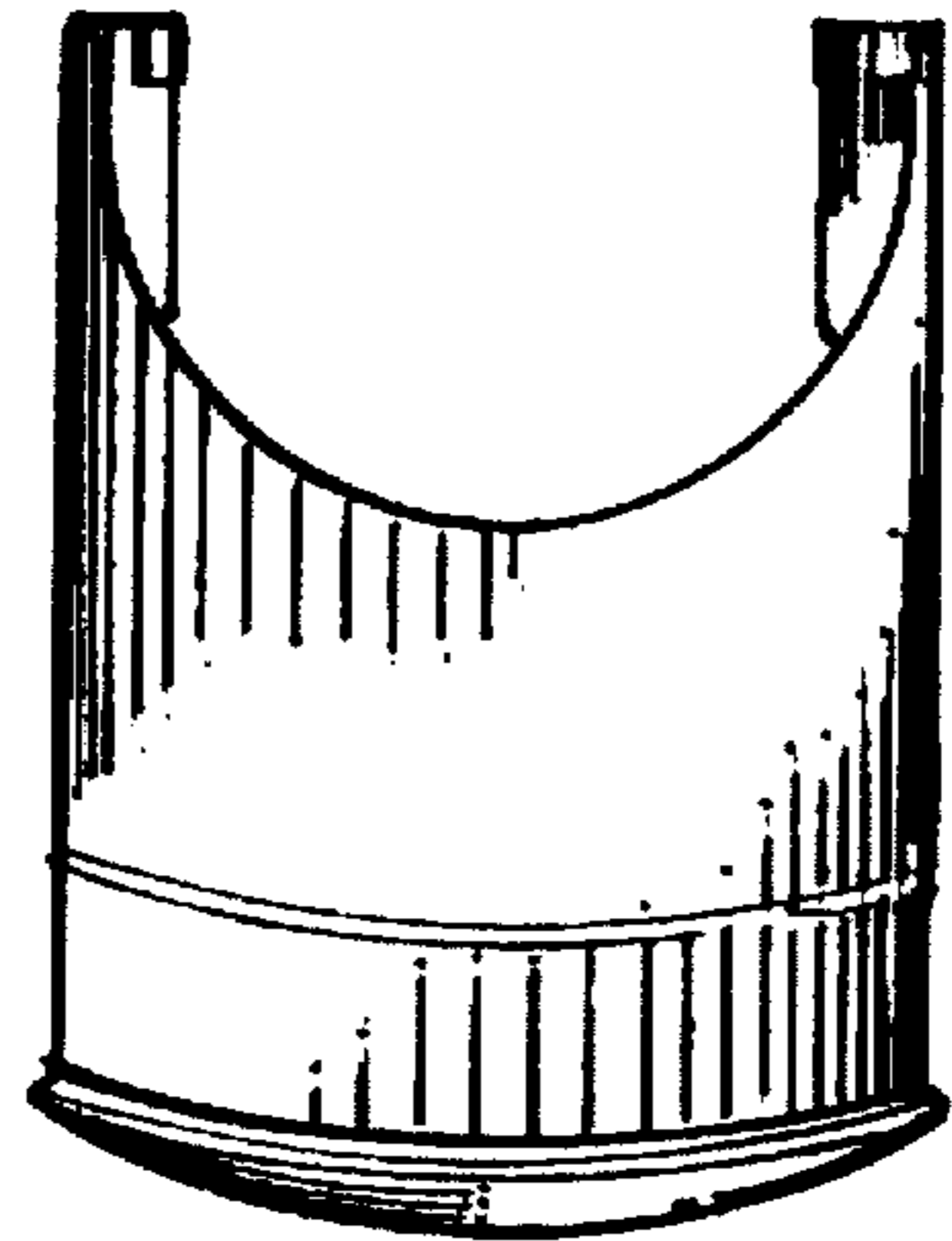

FIG. 5

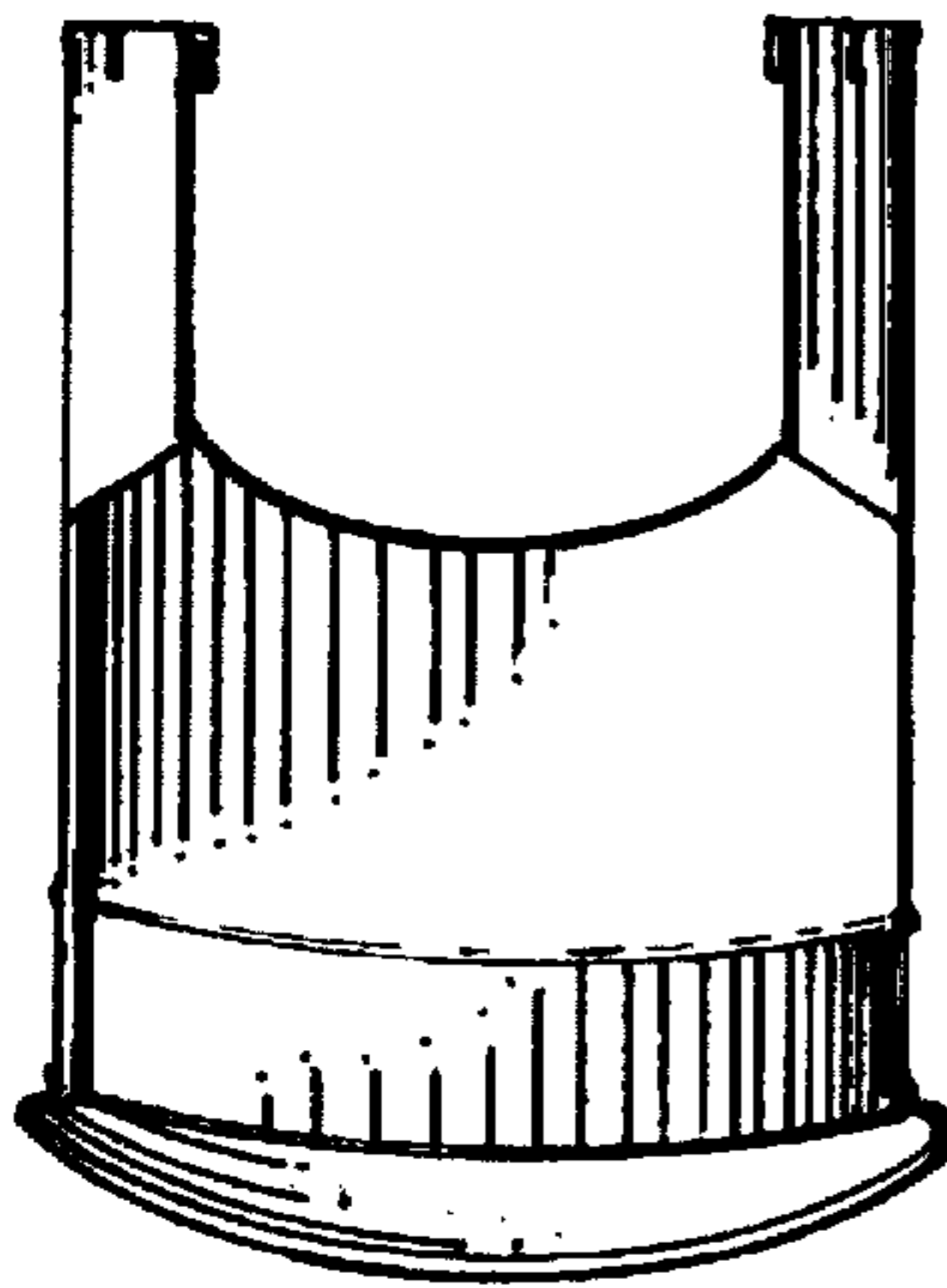

FIG. 6

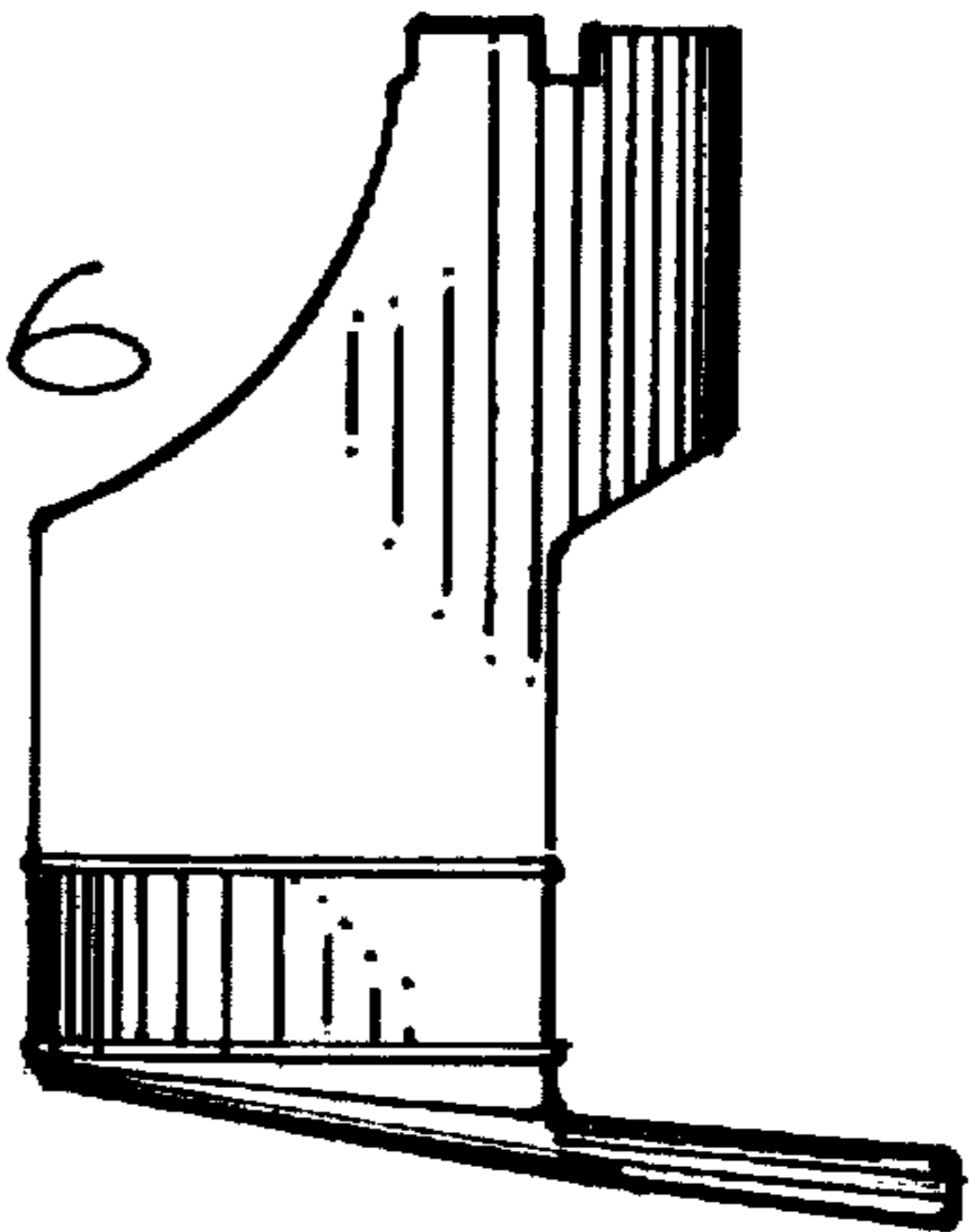
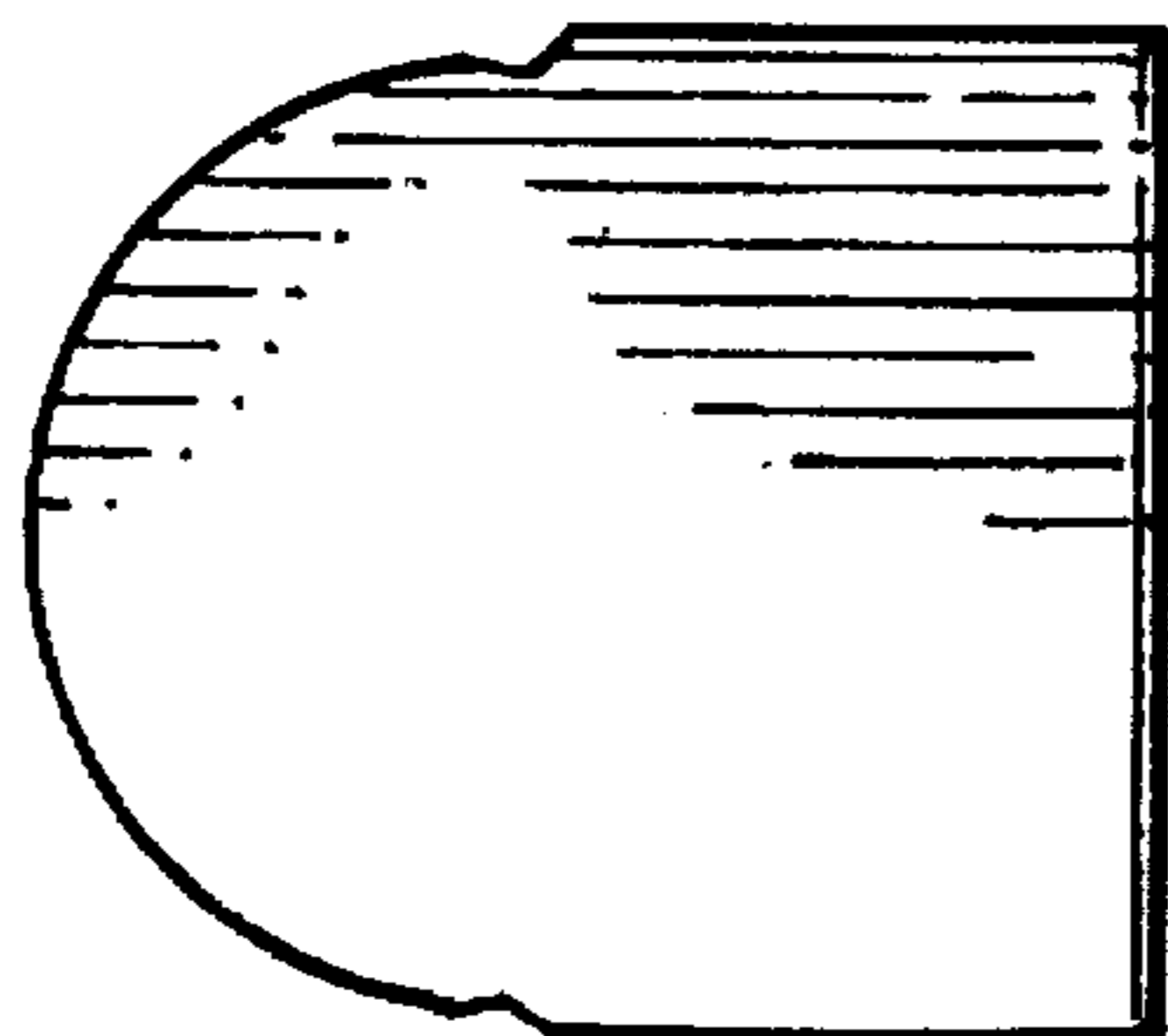

FIG. 7



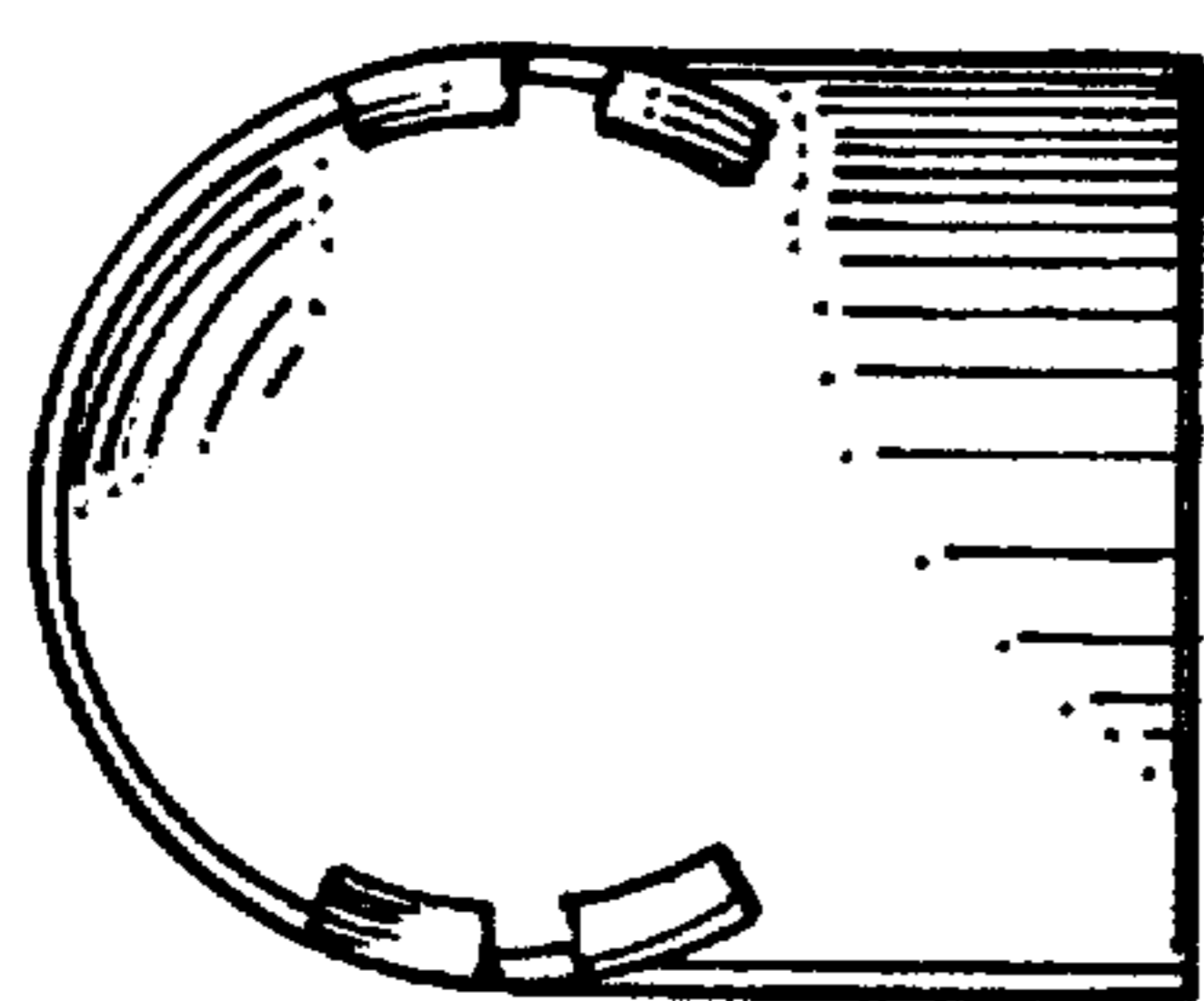

FIG. 8

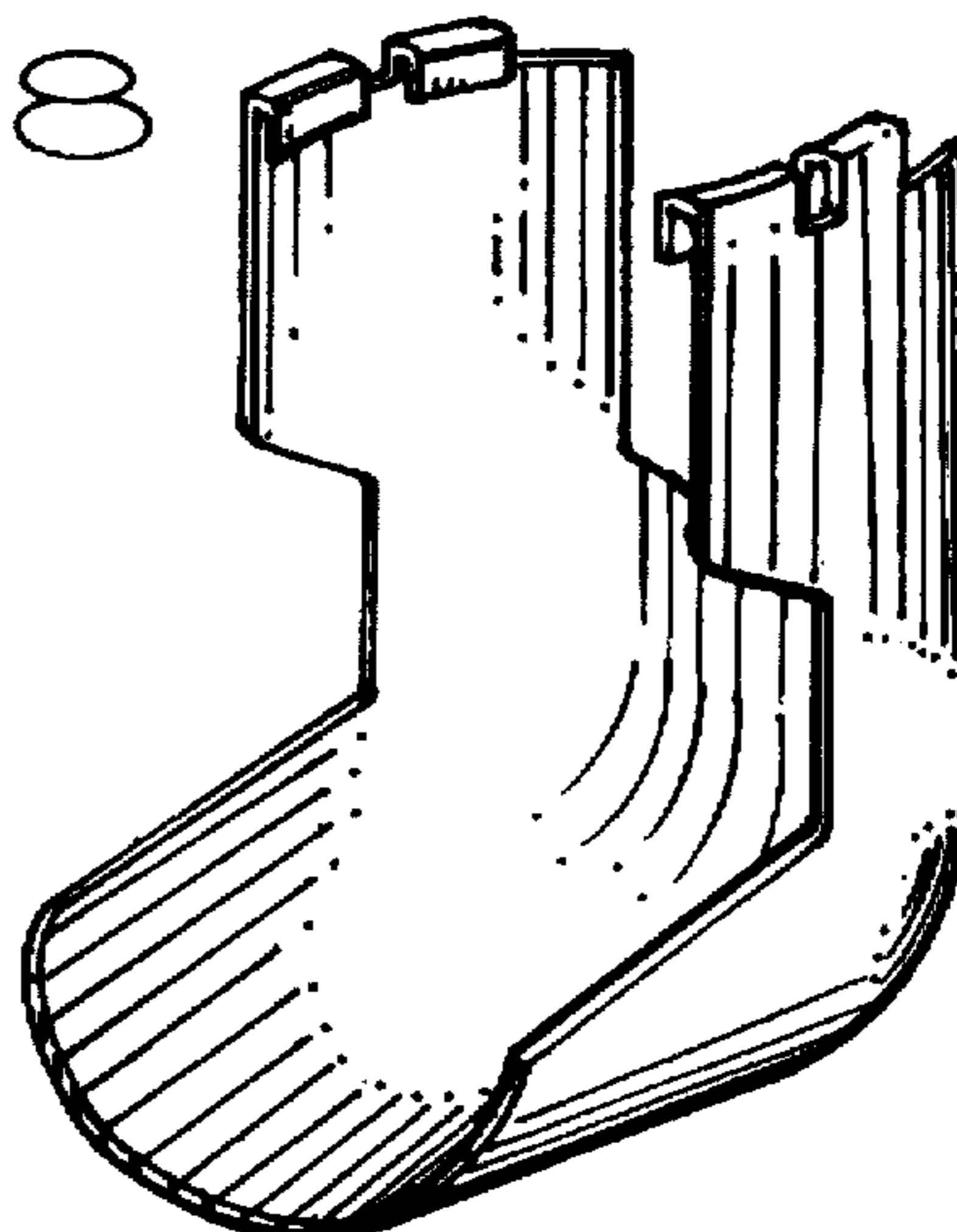

FIG. 9

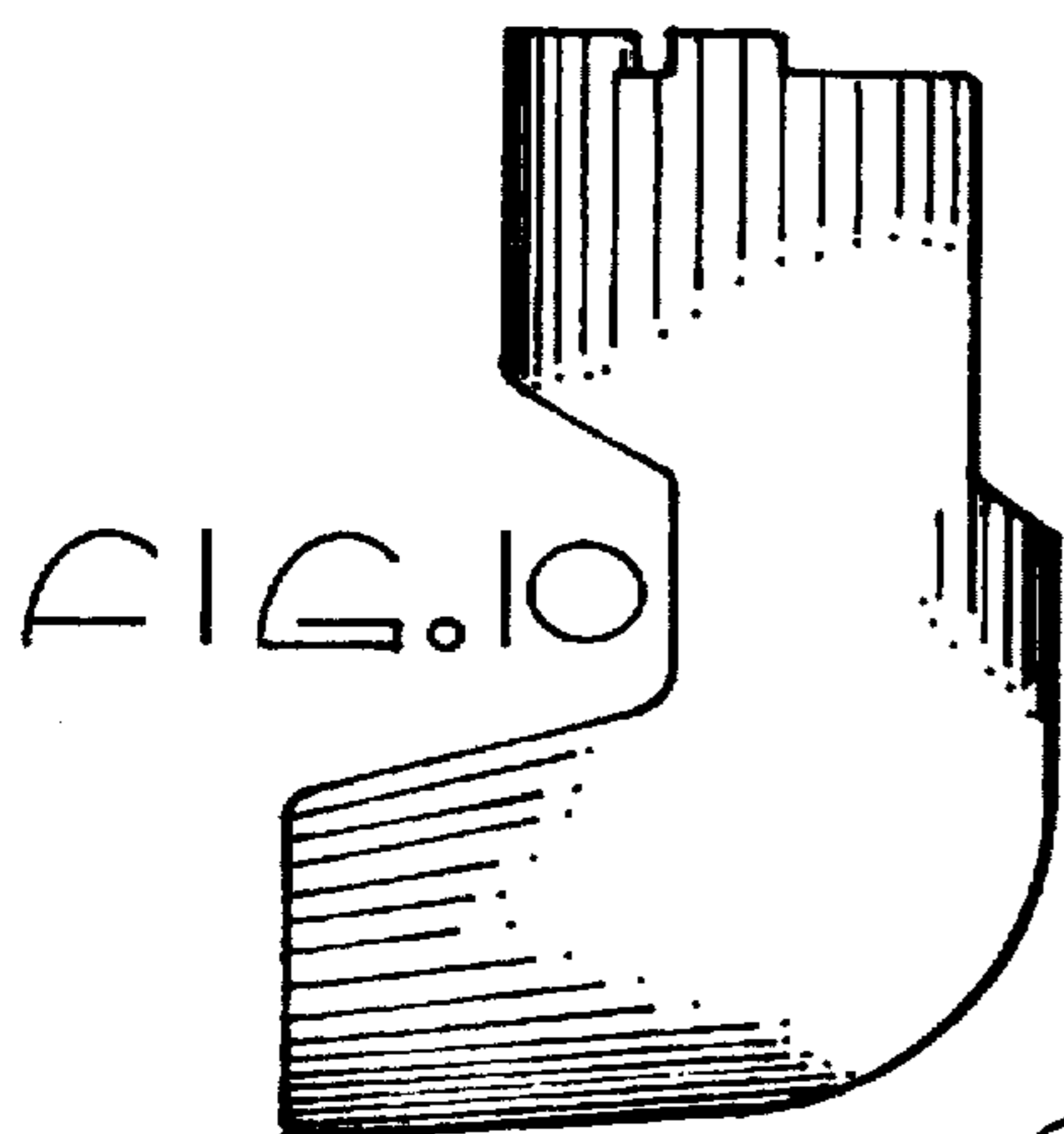

FIG. 10

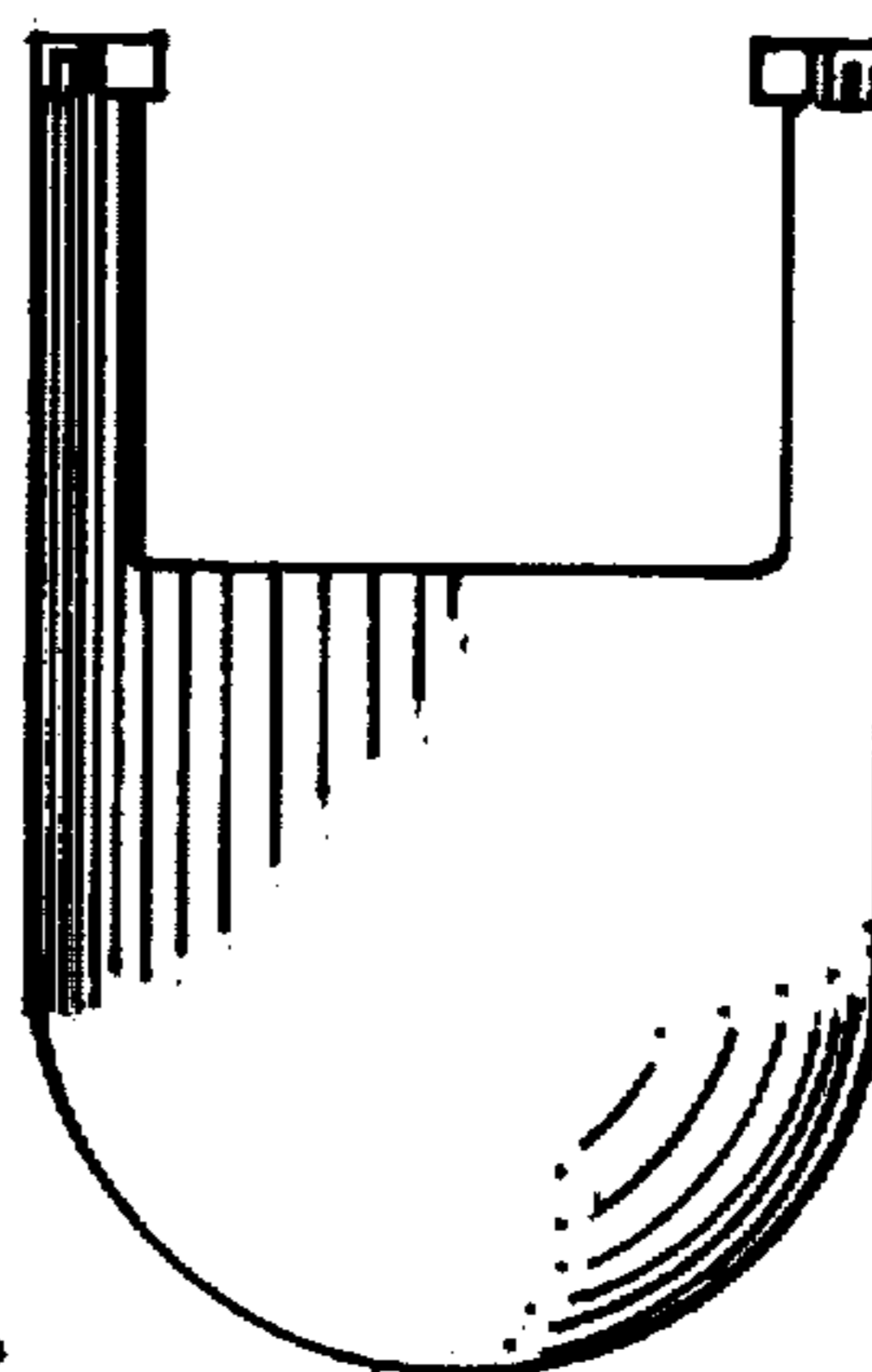

FIG. 11

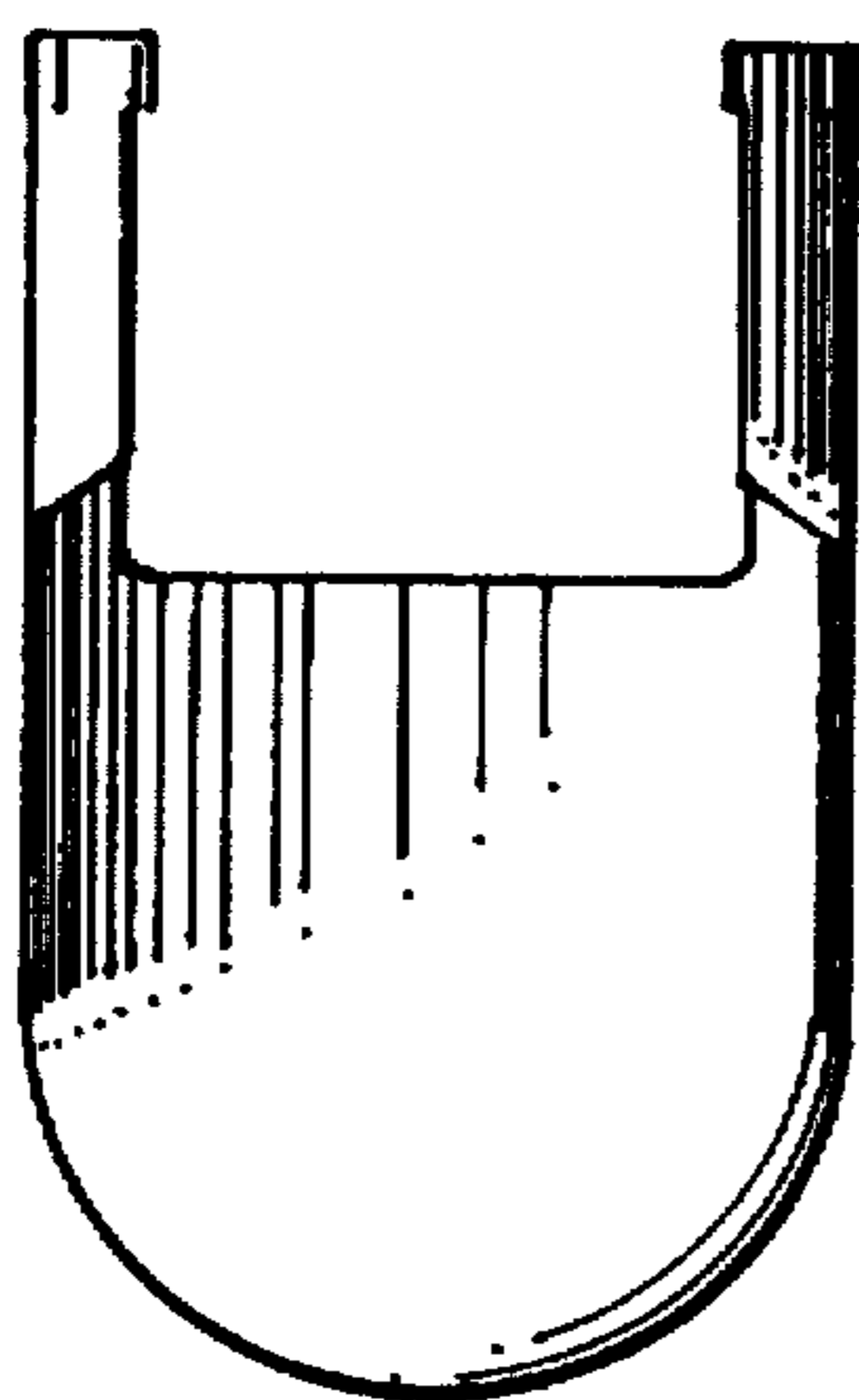

FIG. 12



FIG. 13

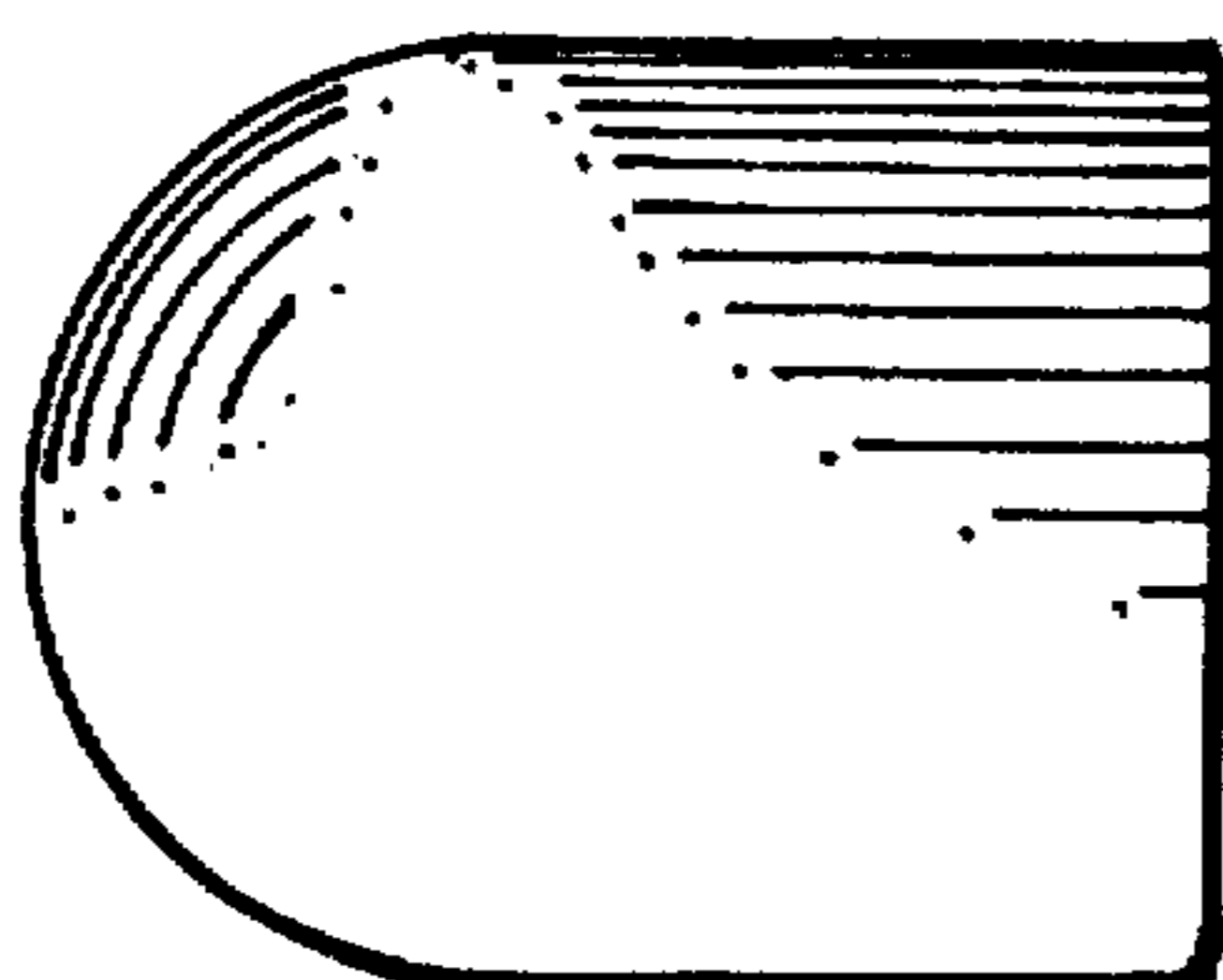

FIG. 14