



US00D384656S

United States Patent [19]
Caramanoff

[11] **Patent Number:** **Des. 384,656**
[45] **Date of Patent:** ****Oct. 7, 1997**

[54] **DUST COVER FOR A COMPUTER OR PRINTER**

MacWarehouse catalog items ABCOM dust covers, p. 142 Jun. 1994.

[76] **Inventor:** **John Paul Caramanoff**, 3375 Homestead Rd., Apt. 20, Santa Clara, Calif. 95051

Primary Examiner—M. H. Tung

[**] **Term:** **14 Years**

[57] **CLAIM**

[21] **Appl. No.:** **43,464**

The ornamental design for a dust cover for a computer or printer, as shown and described.

[22] **Filed:** **Sep. 5, 1995**

DESCRIPTION

[51] **LOC (6) Cl.** **14-02**

[52] **U.S. Cl.** **D14/114**

[58] **Field of Search** D14/114, 100; D18/50, 54, 56; 181/200-201; 150/154, 157, 164-66

FIG. 1 is a front elevational view of the dust cover for a computer or printer showing my new design;

FIG. 2 is a rear elevational view thereof;

FIG. 3 is a right view thereof;

FIG. 4 is a left view thereof;

FIG. 5 is a top plan view thereof;

FIG. 6 is a bottom plan view thereof; and,

FIG. 7 is a perspective view thereof.

[56] **References Cited**

U.S. PATENT DOCUMENTS

D. 237,754	11/1975	Ray	D14/114
D. 323,929	2/1992	Hodson	D14/114
D. 349,893	8/1994	Bennett	D14/114
2,958,357	11/1960	Vorgan	150/165 X
5,080,155	1/1992	Crozier	150/154
5,226,521	7/1993	Oden	150/154 X

OTHER PUBLICATIONS

Lyben catalog items universal vinyl dust covers, type A-C, p. 22 Mar. 1994.
MacWarehouse catalog items basic needs nylon dust covers, p. 139 Jun. 1994.

The broken line drawing of an insert in FIGS. 1 and 7 is for illustrative purposes only and forms no part of the claimed design.

1 Claim, 4 Drawing Sheets

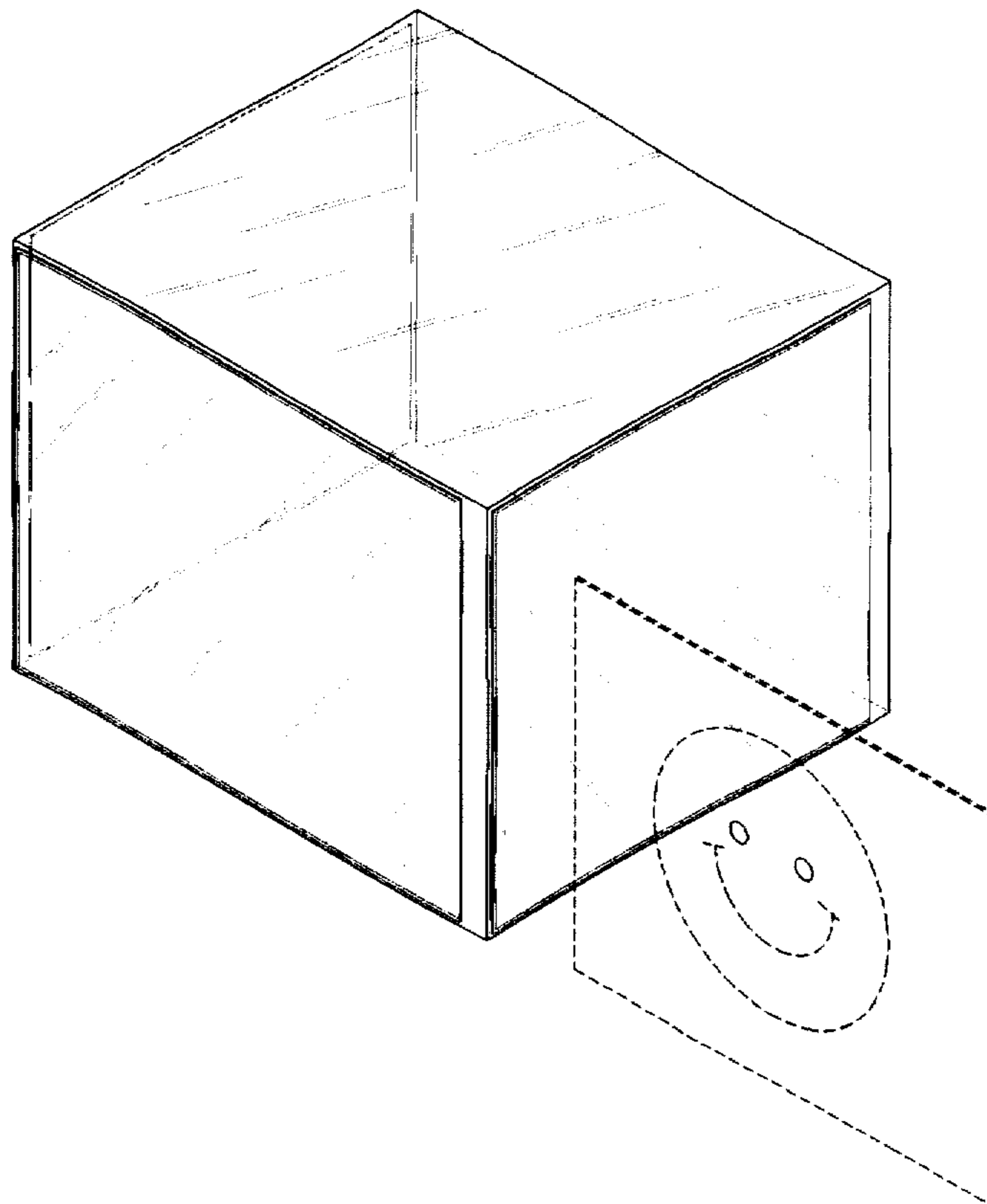

FIG. 1

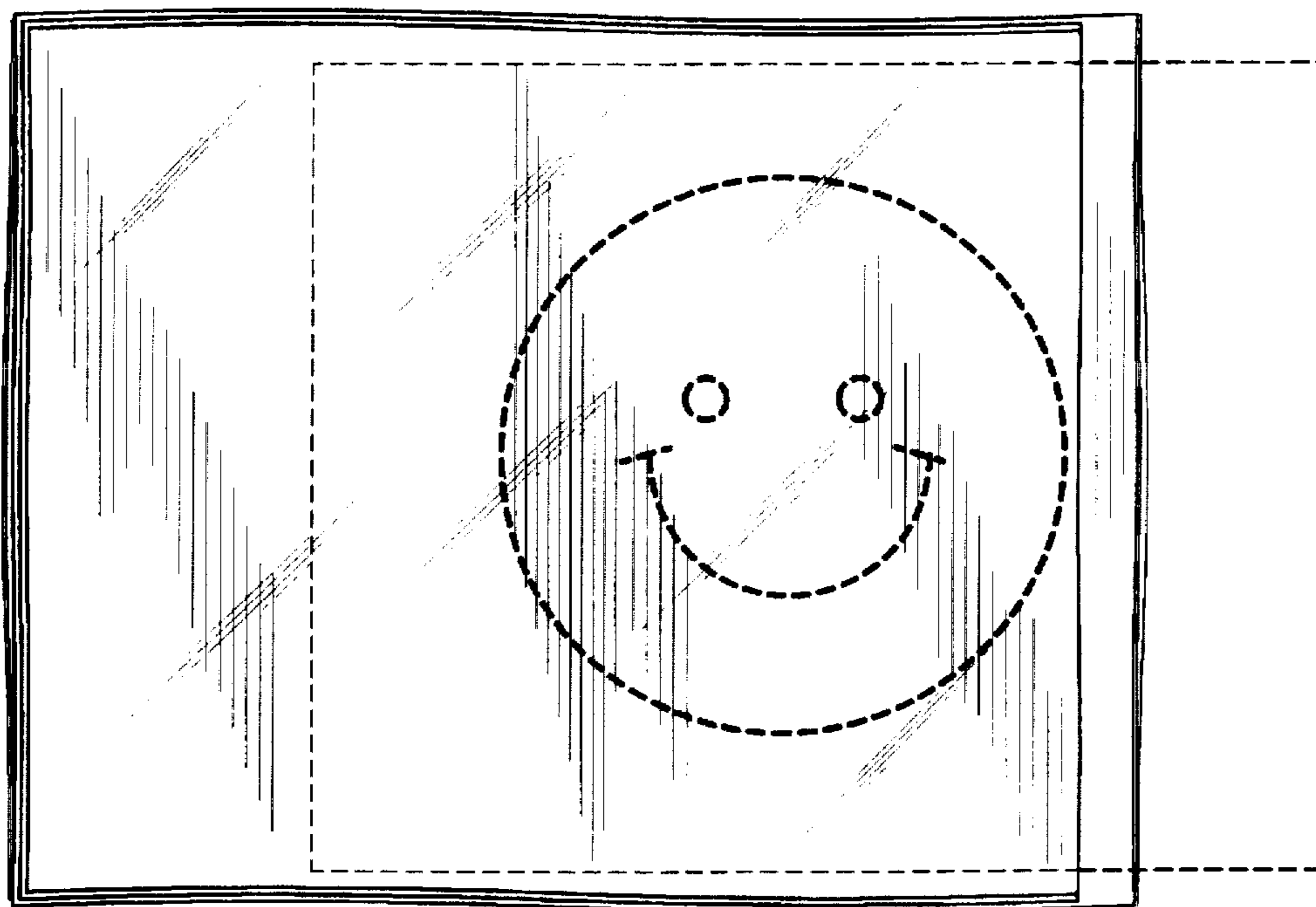

FIG. 2

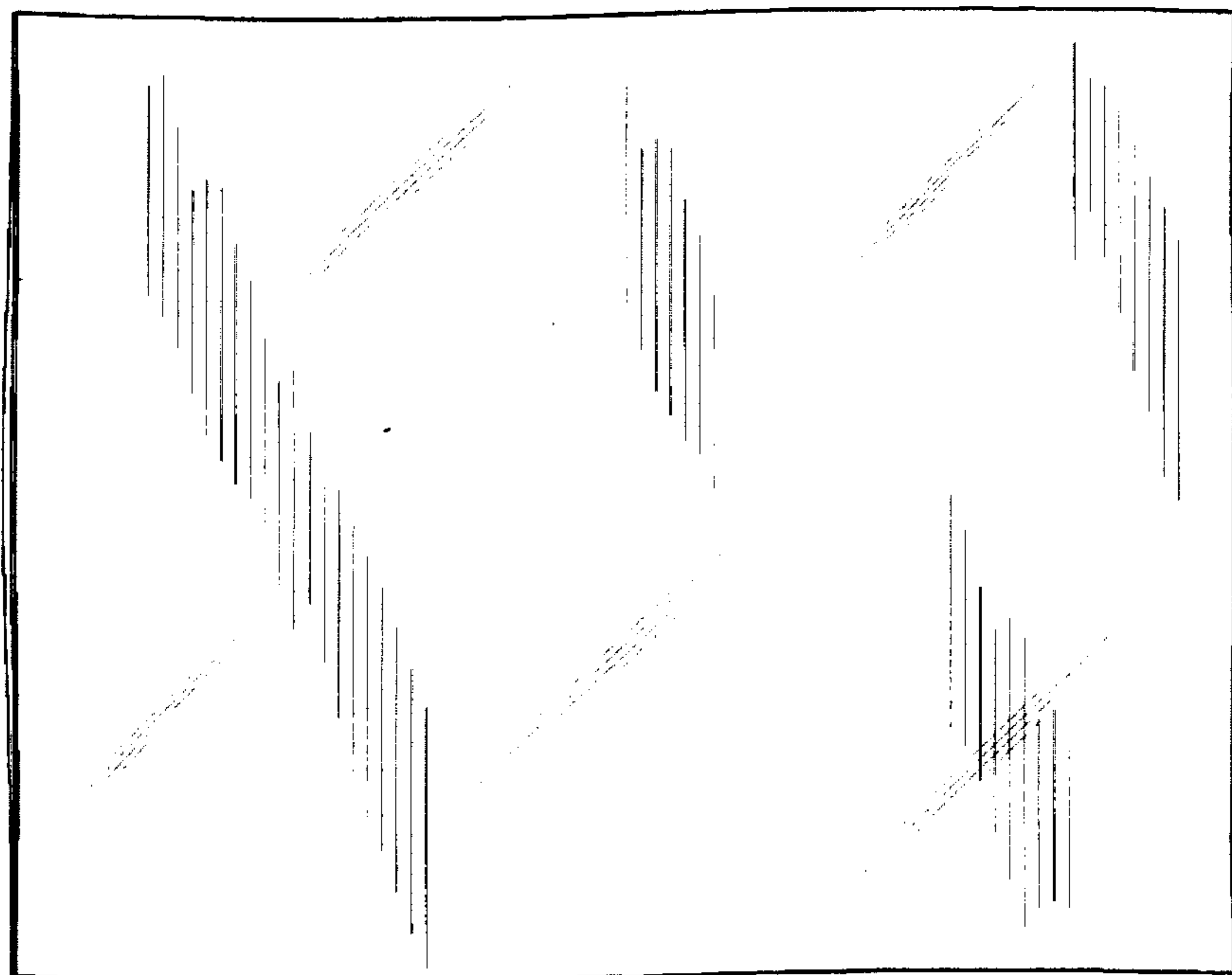

FIG. 3

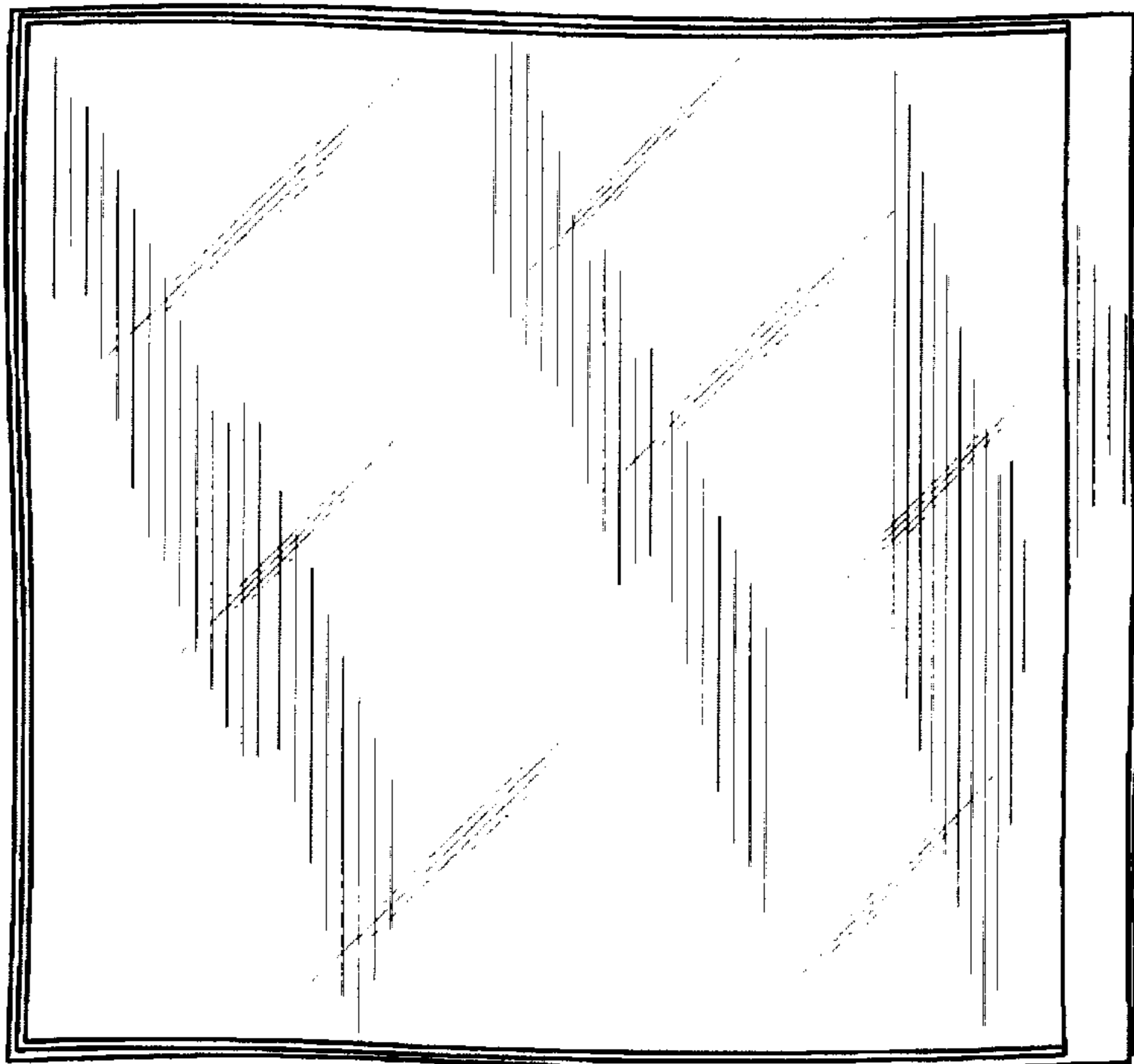

FIG. 4

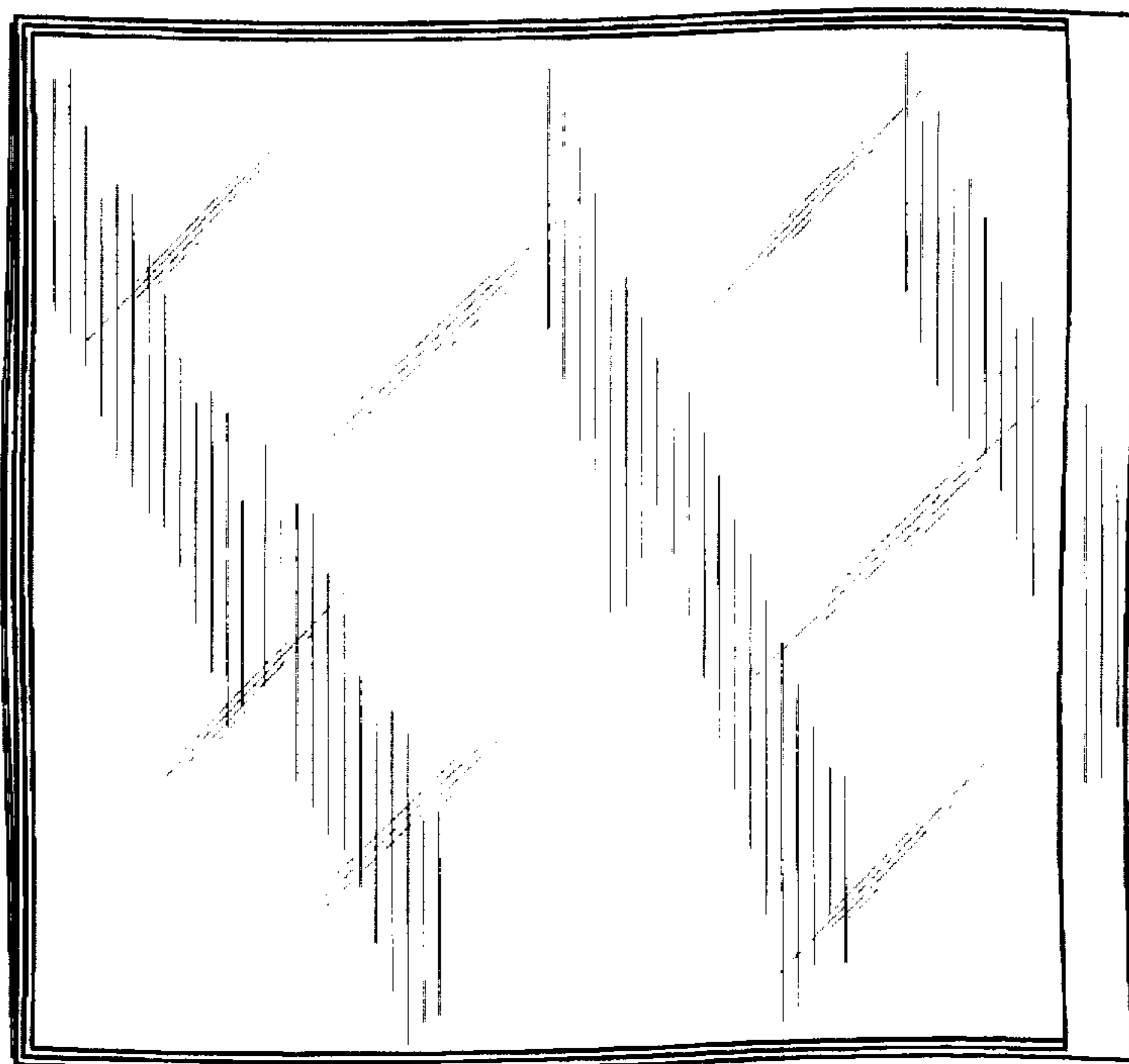

FIG. 5

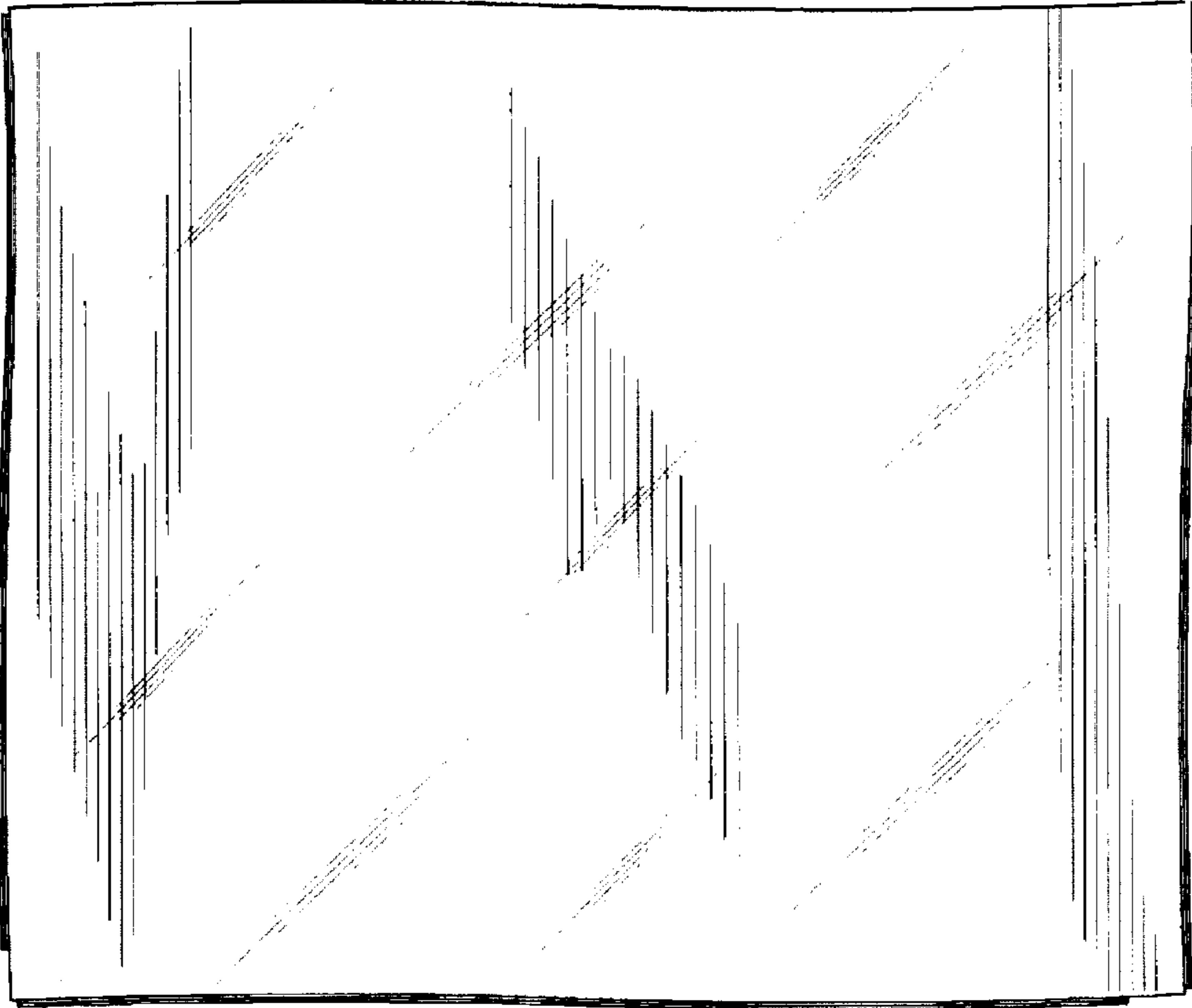

FIG. 6

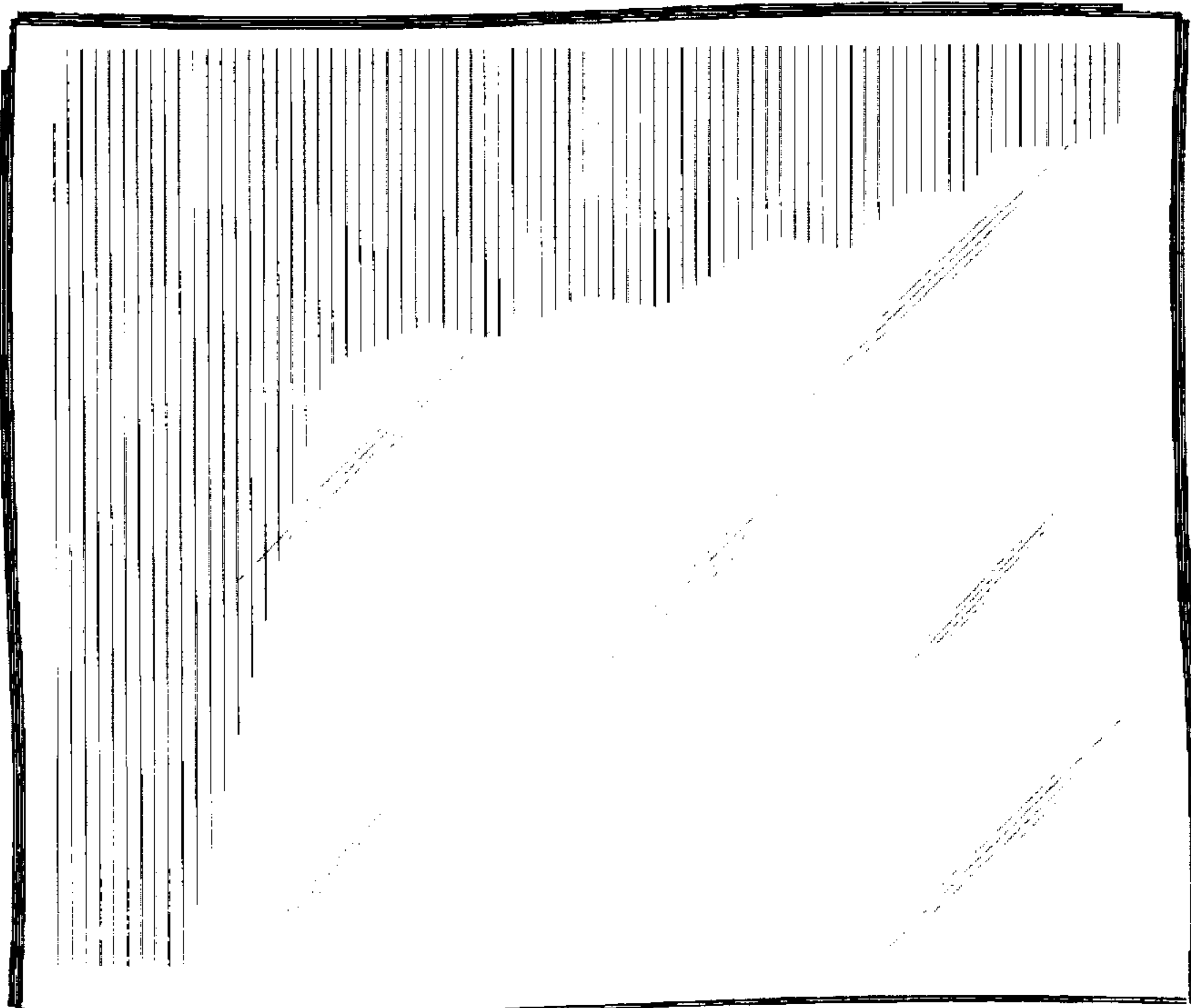

FIG. 7

