



US00D384637S

**United States Patent** [19]  
**Kinkead**

[11] **Patent Number:** **Des. 384,637**  
[45] **Date of Patent:** **\*\*Oct. 7, 1997**

[54] **NOSE CONE FOR JET SKI**

5,357,890 10/1994 Mason, Jr. et al. .... 114/219  
5,564,358 10/1996 Newton ..... 114/361

[76] **Inventor:** **Alan Kinkead**, 4650 W. Rte. K.  
Columbia, Mo. 65203

*Primary Examiner*—Kay H. Chin  
*Attorney, Agent, or Firm*—Kokjer, Kircher, Bowman &  
Johnson

[\*\*] **Term:** **14 Years**

[57] **CLAIM**

[21] **Appl. No.:** **62,948**

The ornamental design for a nose cone for jet ski, as shown  
and described.

[22] **Filed:** **Sep. 19, 1996**

[51] **LOC (6) Cl.** ..... **12-06**

**DESCRIPTION**

[52] **U.S. Cl.** ..... **D12/317; D12/318**

FIG. 1 is a side elevation view showing the environment of  
the present invention with the device on a jet ski shown in  
broken lines;

[58] **Field of Search** ..... **D12/317, 318;**  
**114/361, 364, 343, 219**

FIG. 2 is a top plan elevation view thereof;

FIG. 3 is a side elevation view thereof;

FIG. 4 is a left end view of FIG. 3;

FIG. 5 is a right end view of FIG. 3; and,

FIG. 6 is a bottom plan view thereof.

[56] **References Cited**

**U.S. PATENT DOCUMENTS**

D. 370,657 6/1996 Block, Jr. .... D12/317  
4,815,412 3/1989 Cassaro, Jr. .... 114/219 X  
5,291,848 3/1994 Wilhelm et al. .... 114/343 X

**1 Claim, 2 Drawing Sheets**

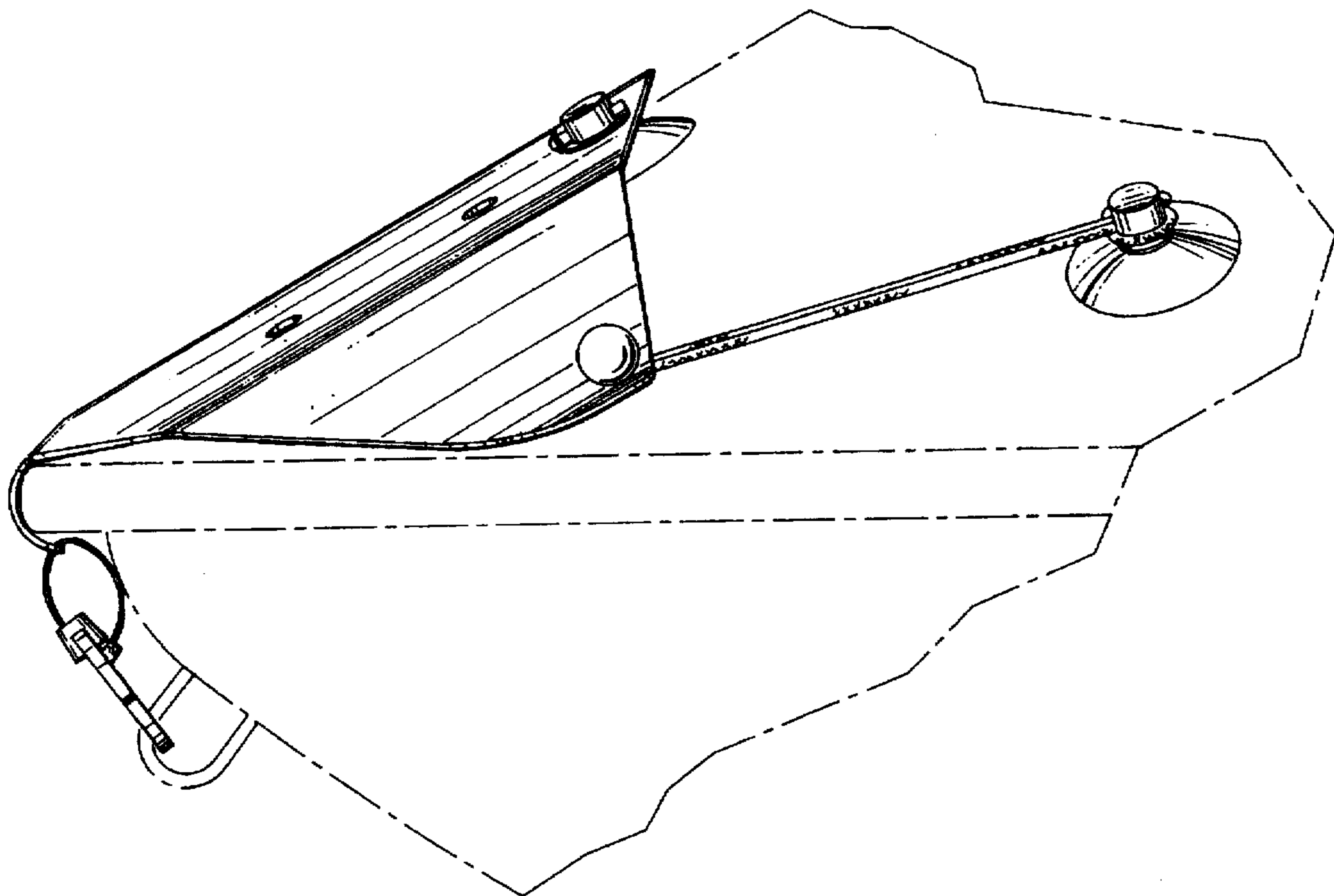

*Fig. 1.*

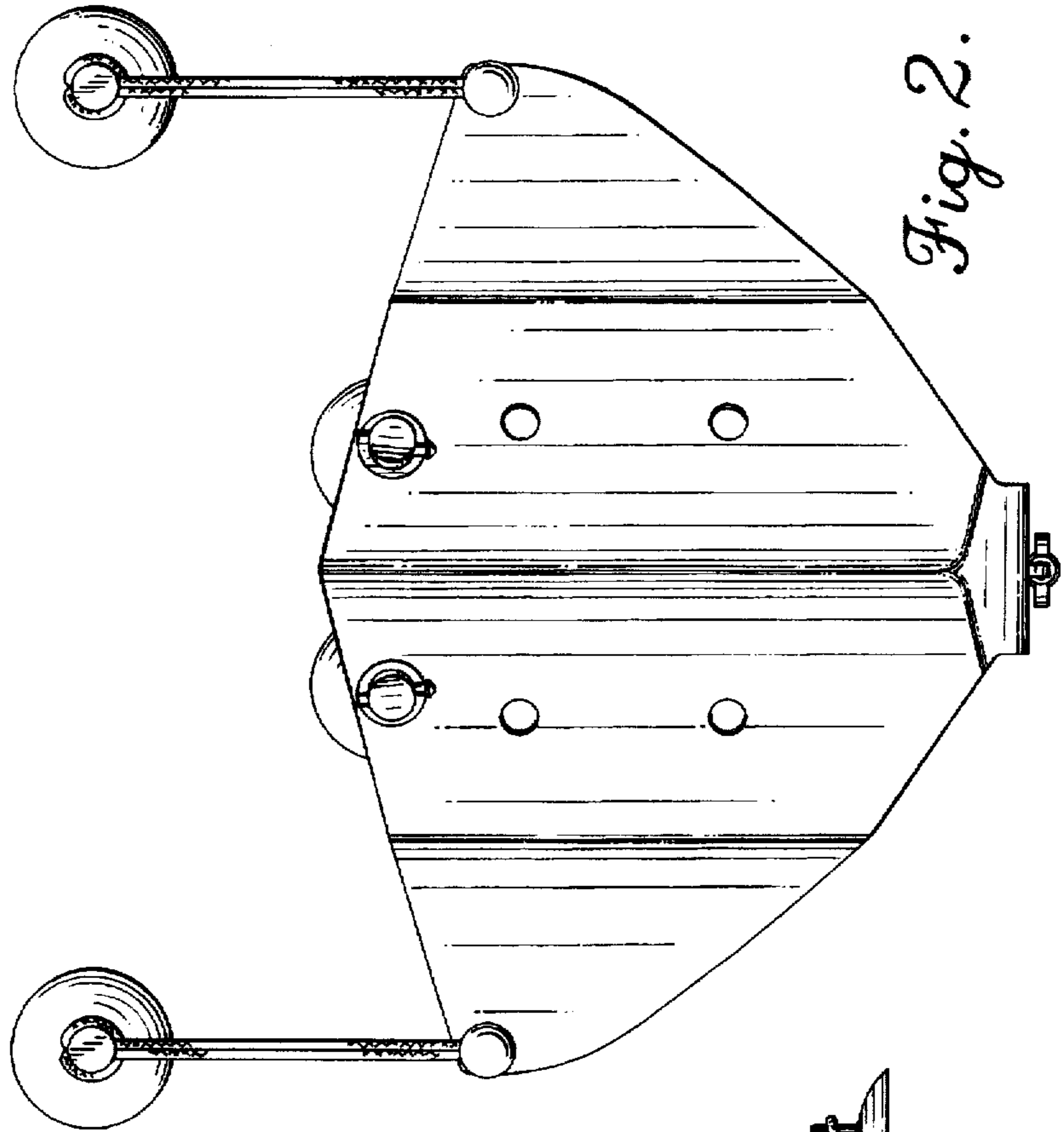
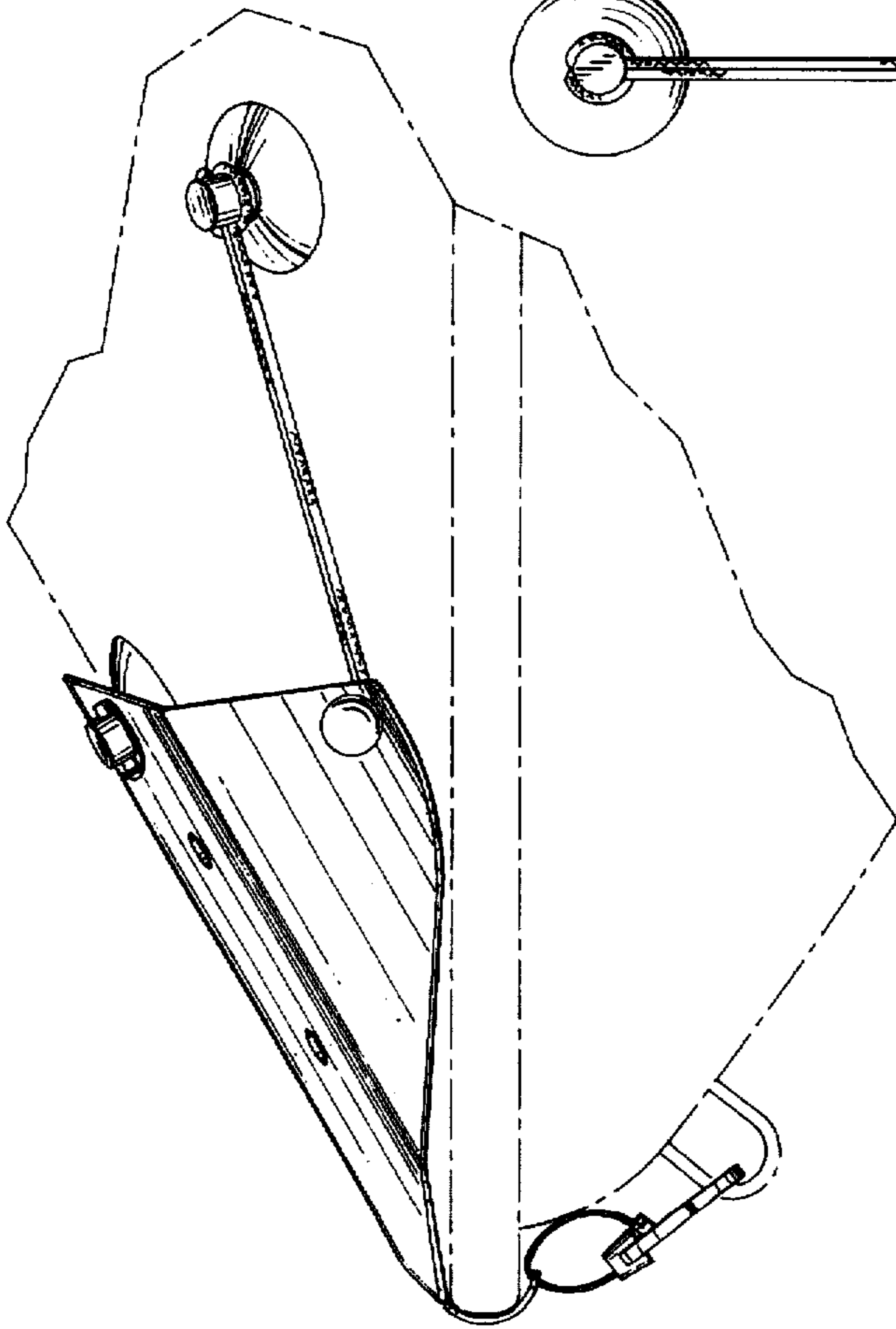

*Fig. 2.*

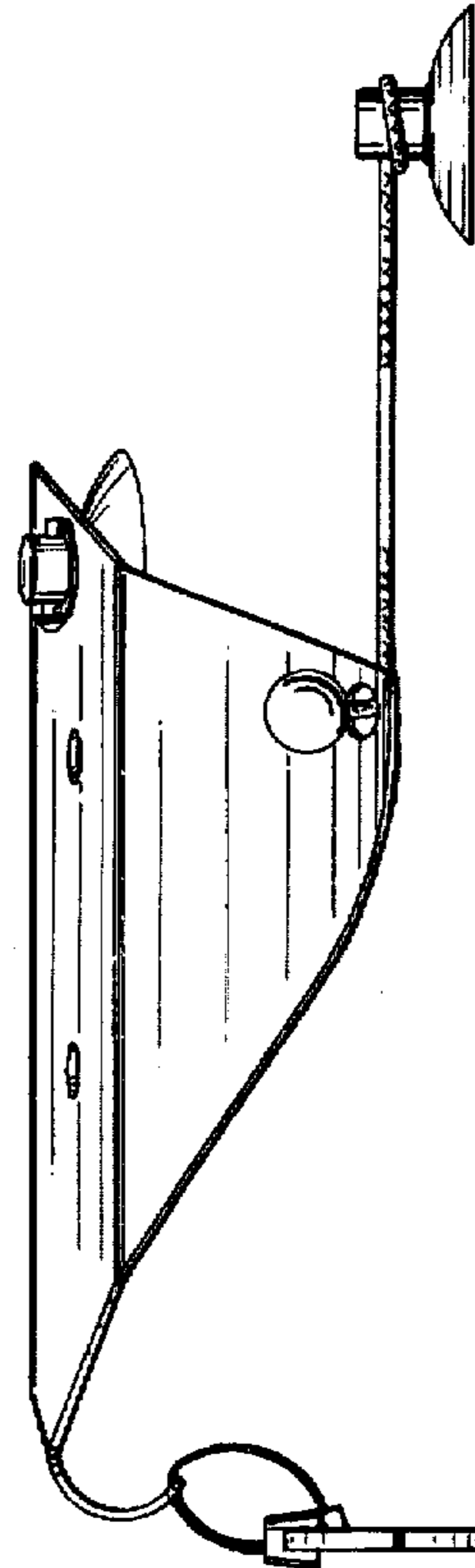

*Fig. 3.*

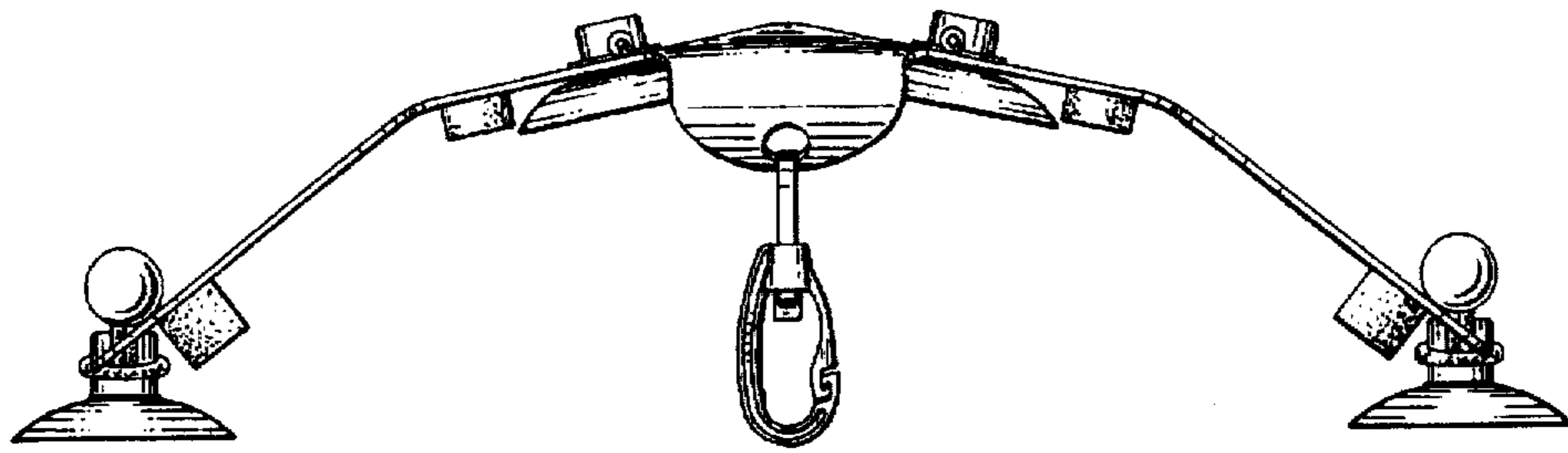

*Fig. 4.*

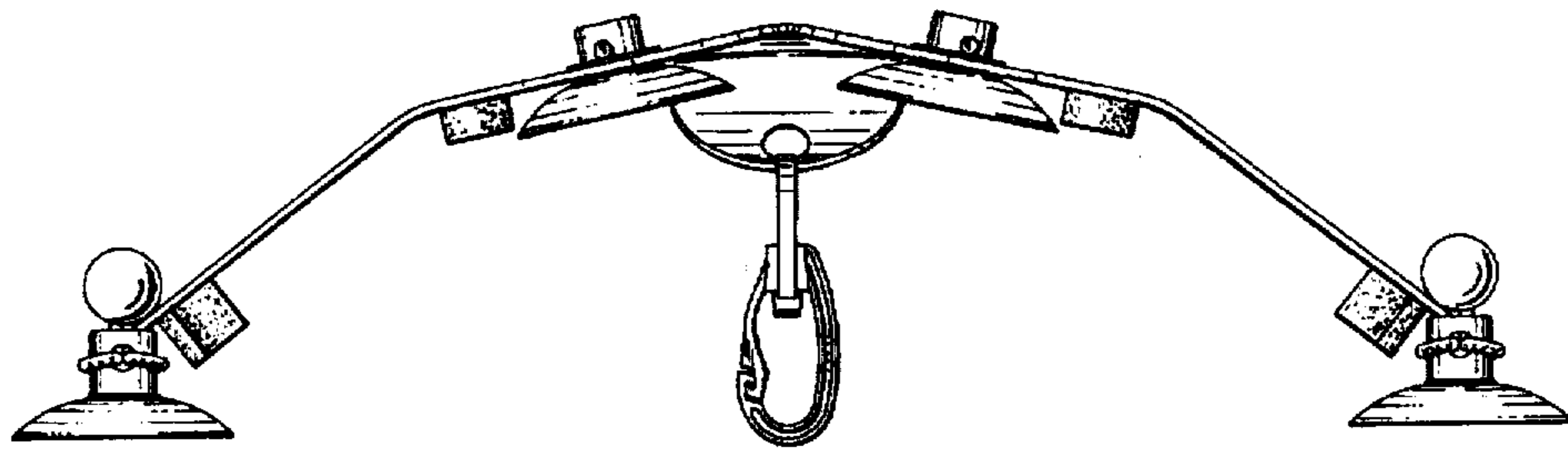

*Fig. 5.*

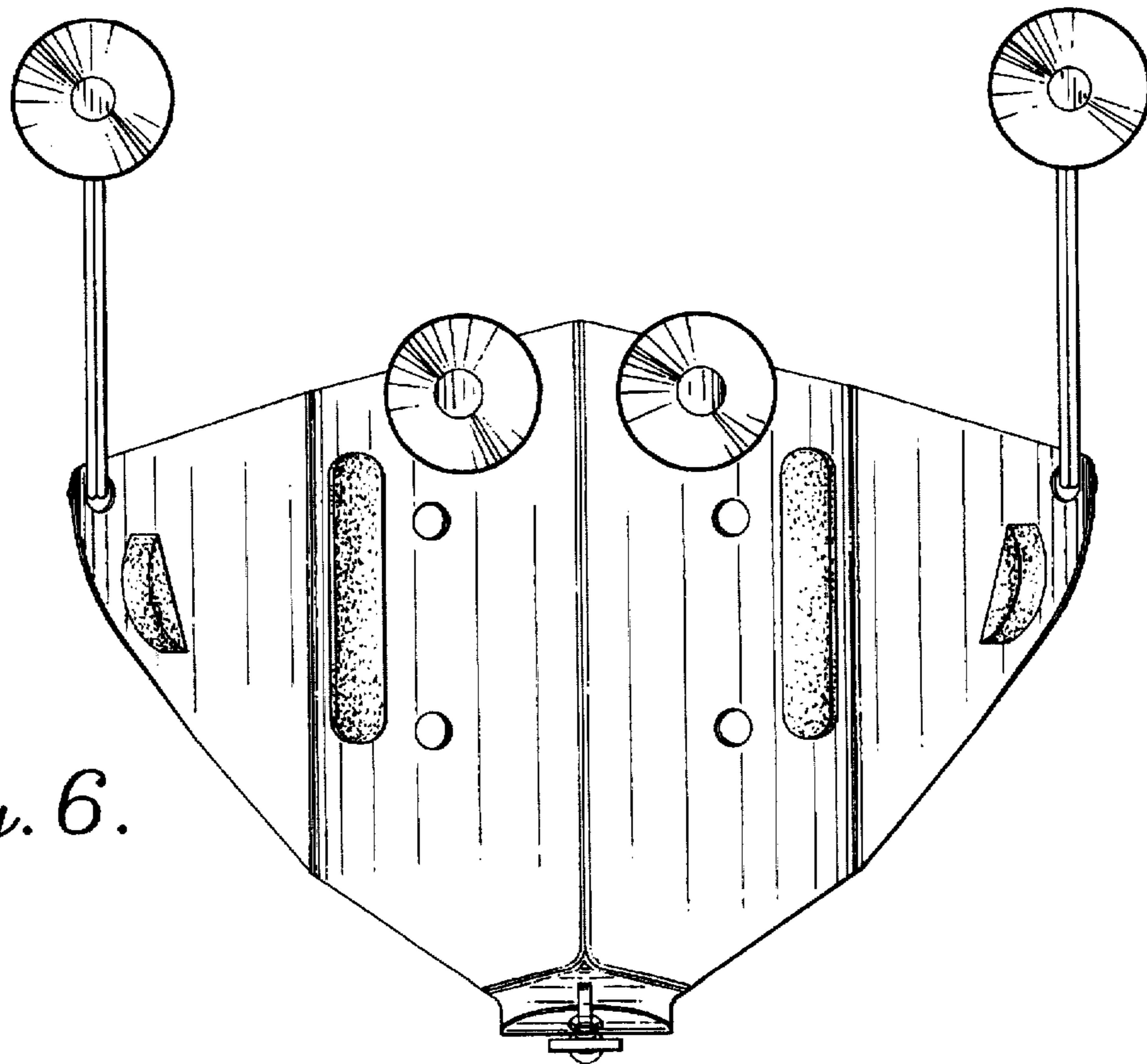

*Fig. 6.*