



US00D384579S

# United States Patent [19] Lee

[11] Patent Number: **Des. 384,579**  
[45] Date of Patent: **\*\*Oct. 7, 1997**

[54] **PACKAGING FOR CABLES**

[75] Inventor: **Noel Lee, Daly City, Calif.**

[73] Assignee: **Monster Cable International, Ltd.**  
**Bermuda**

[\*\*] Term: **14 Years**

[21] Appl. No.: **60,101**

[22] Filed: **Sep. 23, 1996**

[51] LOC (6) Cl. .... **09-07**

[52] U.S. Cl. .... **D9/415**

[58] Field of Search ..... **D9/415, 418, 414,**  
**D9/337; 206/461-471, 806, 495, 525, 225,**  
**349, 389, 775, 477**

[56] **References Cited**

**U.S. PATENT DOCUMENTS**

- D. 306,561 3/1990 Lee .
- D. 328,249 7/1992 Lee .
- D. 332,216 1/1993 Lee et al. .
- D. 332,398 1/1993 Lee et al. .
- D. 348,392 7/1994 Tannen ..... D9/415
- D. 351,342 10/1994 Lee et al. .
- D. 370,626 6/1996 Pass et al. .... D9/415
- D. 372,193 7/1996 Lee ..... D9/415

- 4,140,218 2/1979 Forte ..... 206/806 X
- 4,531,637 7/1985 Cusmano ..... 206/461
- 5,143,215 9/1992 Hartley et al. .... 206/461 X
- 5,311,989 5/1994 Ward et al. .... 206/471 X
- 5,358,113 10/1994 Hallenbrand ..... 206/463 X

**OTHER PUBLICATIONS**

Techform Inc., Nov. 1982.  
Modern Packaging, 1941, p. 300.  
Modern Packaging, Mar. 1982, p. 22.

*Primary Examiner*—Prabhakar G. Deshmukh  
*Attorney, Agent, or Firm*—Haynes and Boone, L.L.P.

[57] **CLAIM**

The ornamental design for the packaging for cables, as shown and described.

**DESCRIPTION**

FIG. 1 is a perspective view of the packaging for cables showing my new design;  
FIG. 2 is a top plan view thereof;  
FIG. 3 is a front elevational view thereof;  
FIG. 4 is a bottom plan view thereof;  
FIG. 5 is a rear elevational view thereof;  
FIG. 6 is a right side elevational view thereof; and,  
FIG. 7 is a left side elevational view thereof.

**1 Claim, 3 Drawing Sheets**

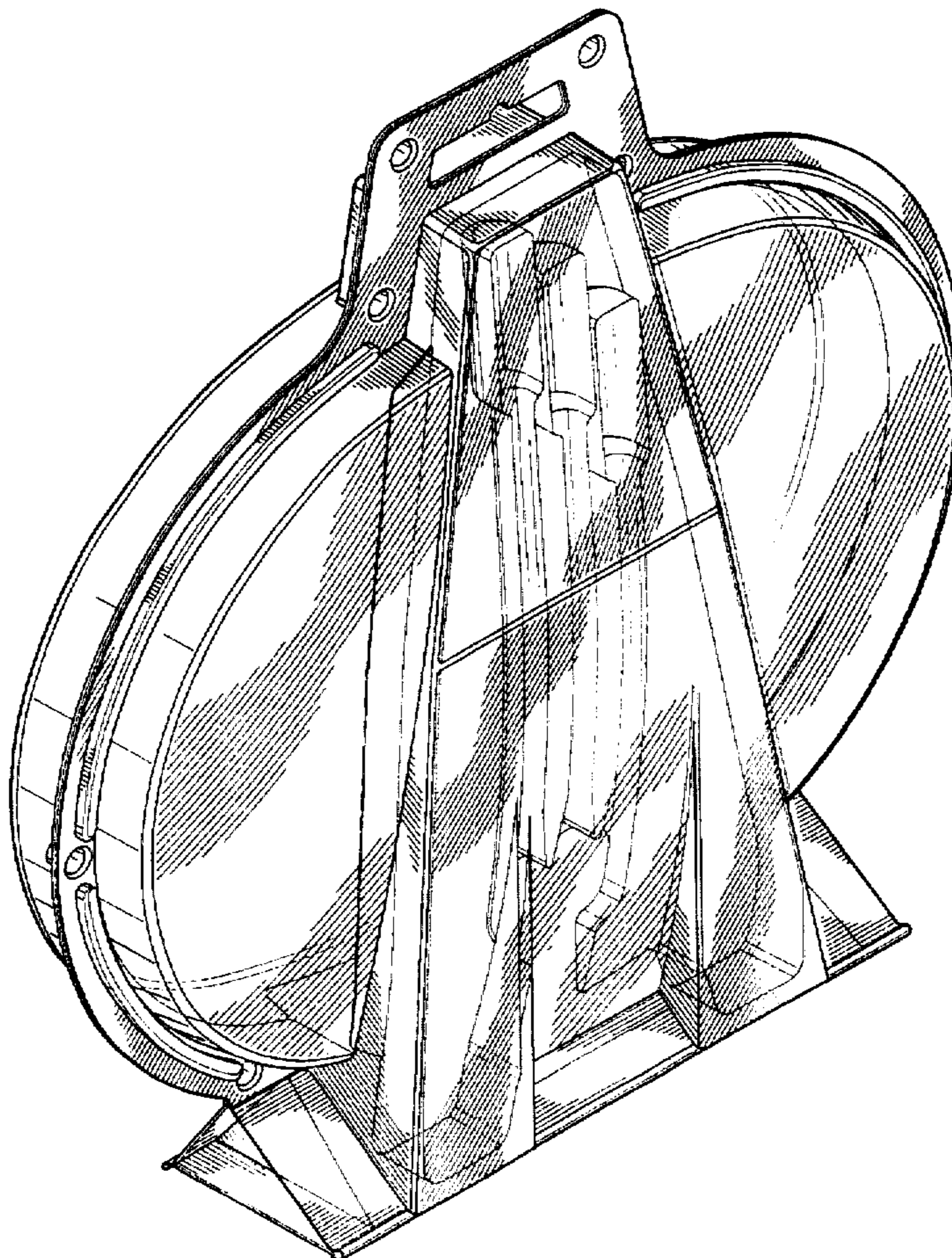



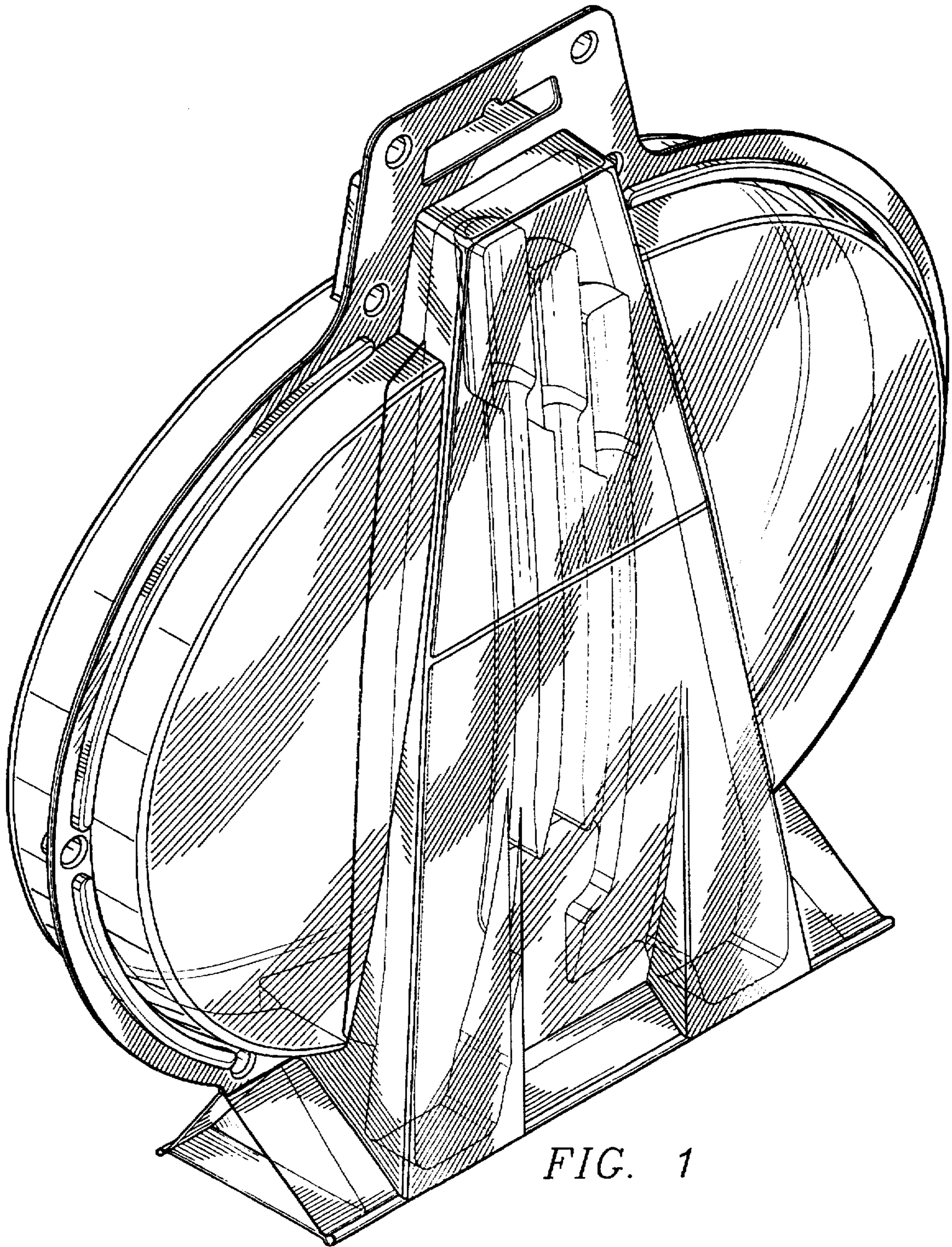

FIG. 1



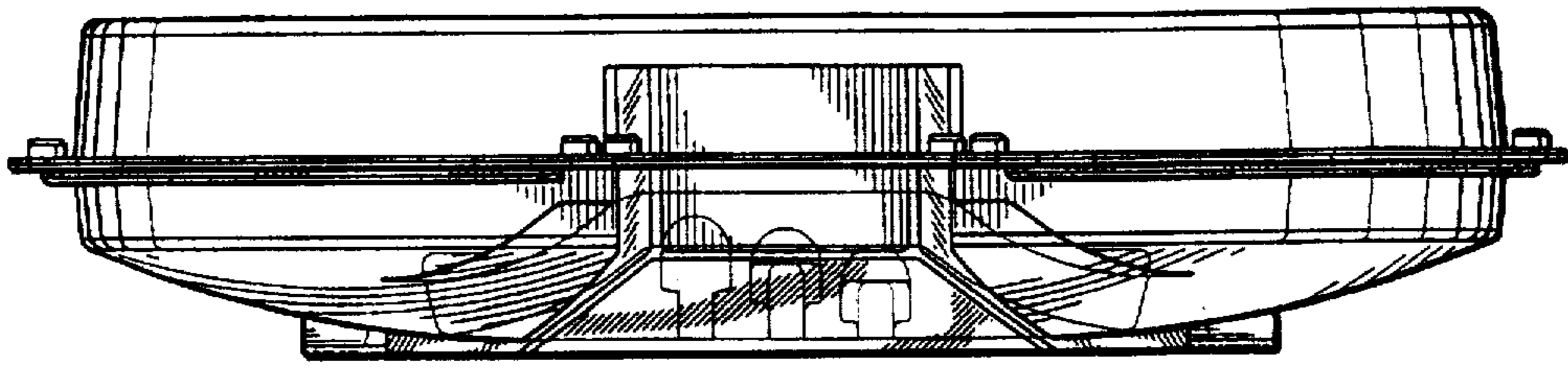

FIG. 2

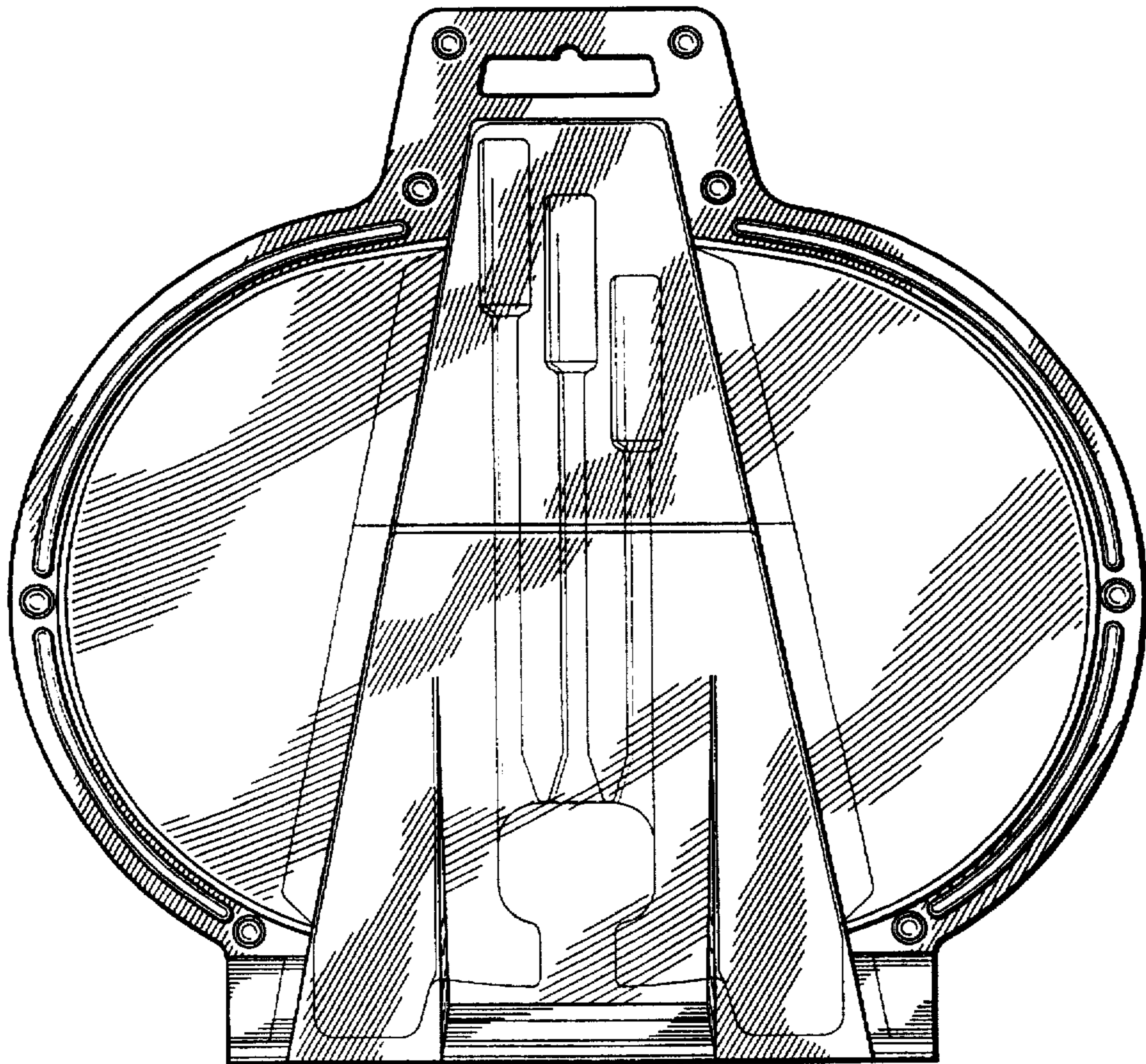

FIG. 3

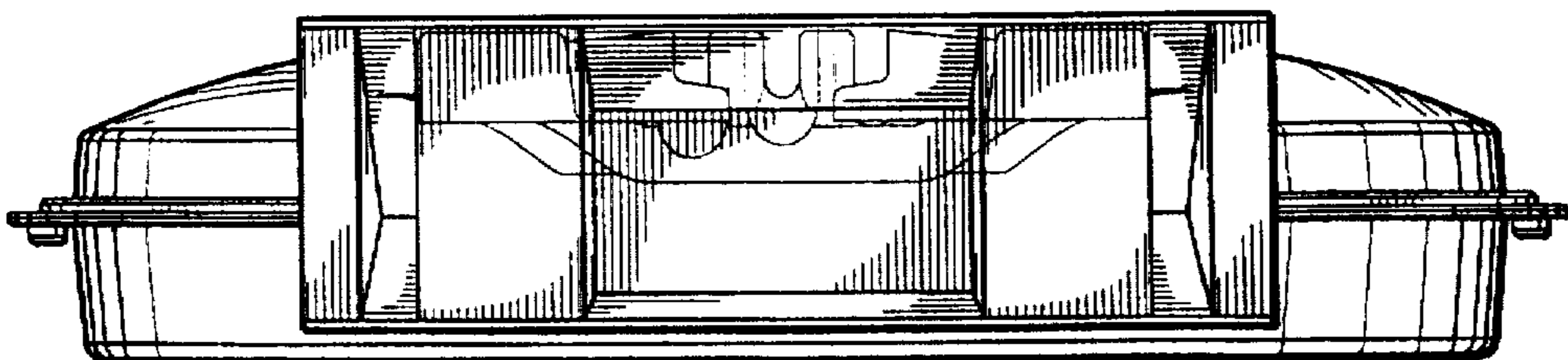

FIG. 4

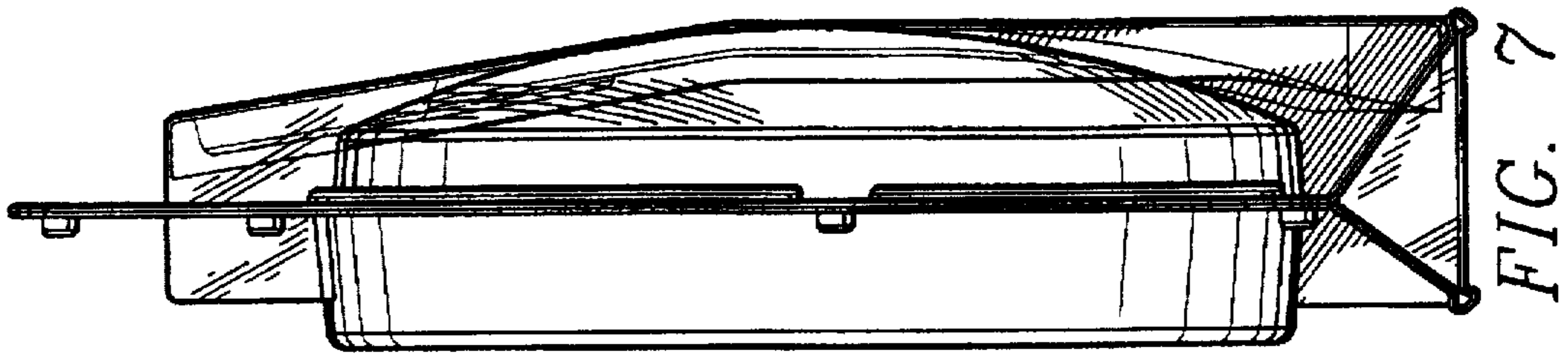

FIG. 7

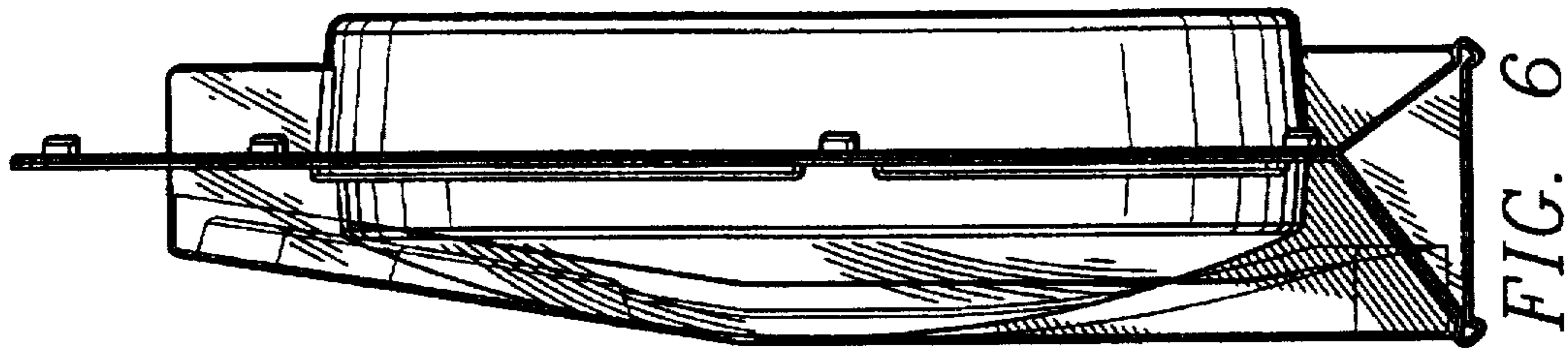

FIG. 6

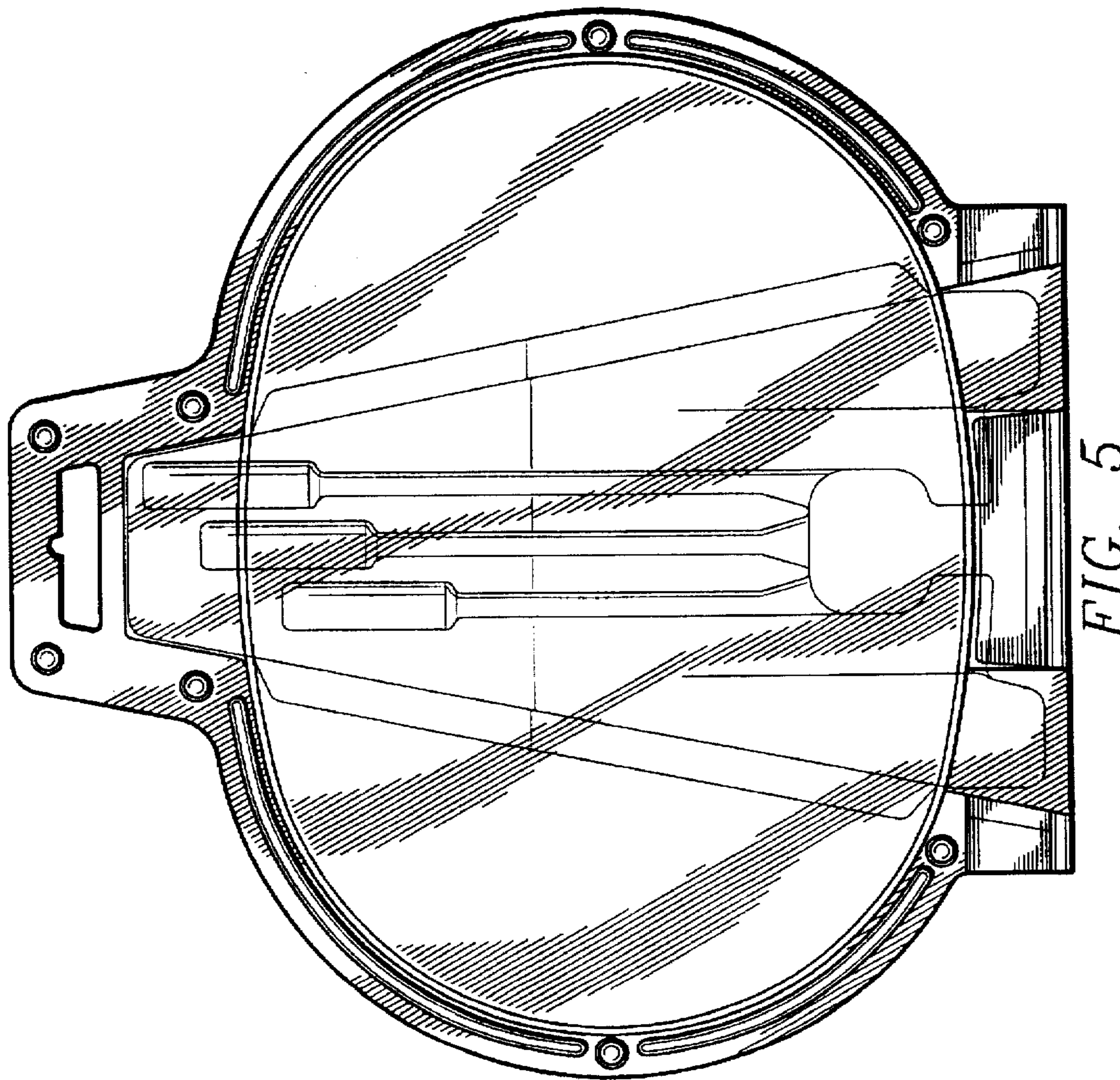

FIG. 5