



US00D384561S

# United States Patent [19] Carbone

[11] Patent Number: **Des. 384,561**  
[45] Date of Patent: **\*\*Oct. 7, 1997**

[54] CAN OPENER

D. 324,157 2/1992 Gildersleve ..... D8/35  
5,313,708 5/1994 Edwards et al. .... 30/423 X

[75] Inventor: **Richard J. Carbone**, Southbury, Conn.

*Primary Examiner*—Caron D. Veynar  
*Attorney, Agent, or Firm*—Barry E. Deutsch

[73] Assignee: **Black & Decker Inc.**, Newark, Del.

[\*\*] Term: **14 Years**

[57] **CLAIM**

[21] Appl. No.: **48,907**

The ornamental design for a can opener, as shown and described.

[22] Filed: **Jan. 16, 1996**

**DESCRIPTION**

[51] LOC (6) Cl. .... **07-99**

FIG. 1 is a perspective view taken from the front, right and top of a can opener illustrating my new design;  
FIG. 2 is a right side elevational view thereof;  
FIG. 3 is a left side elevational view thereof;  
FIG. 4 is a front elevational view thereof;  
FIG. 5 is a rear elevational view thereof;  
FIG. 6 is a top plan view thereof; and,  
FIG. 7 is a bottom plan view thereof.  
FIGS. 2-7 are drawn on a reduced scale from FIG. 1.

[52] U.S. Cl. .... **D8/36**

[58] Field of Search ..... D8/33, 36, 37,  
D8/34; 30/400, 401, 403-405, 416, 421,  
423, 426, 433, 123, 408, 419, 424, 417;  
81/3.2, 3.25, 3.33

[56] **References Cited**

**U.S. PATENT DOCUMENTS**

D. 243,819 3/1977 Avise et al. .... D8/36

**1 Claim, 4 Drawing Sheets**

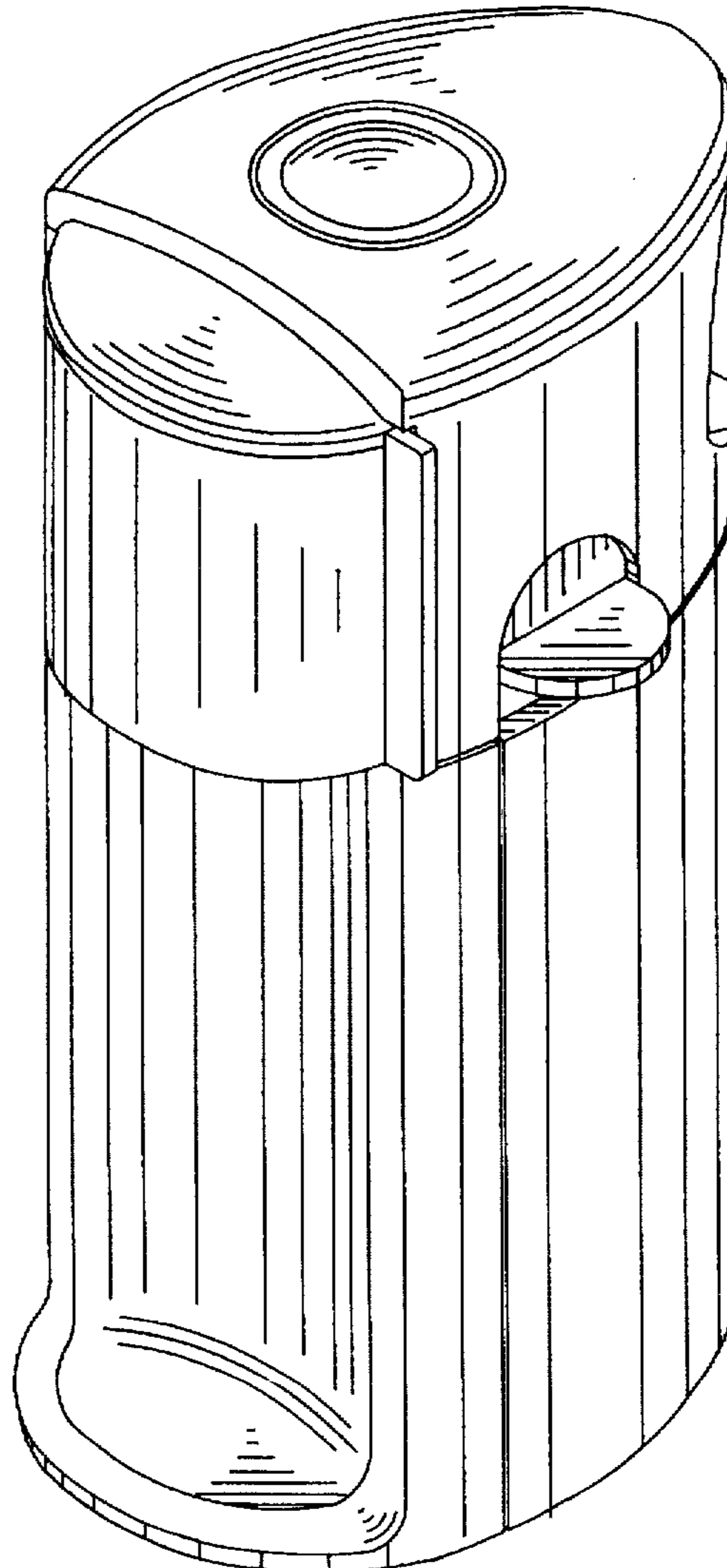
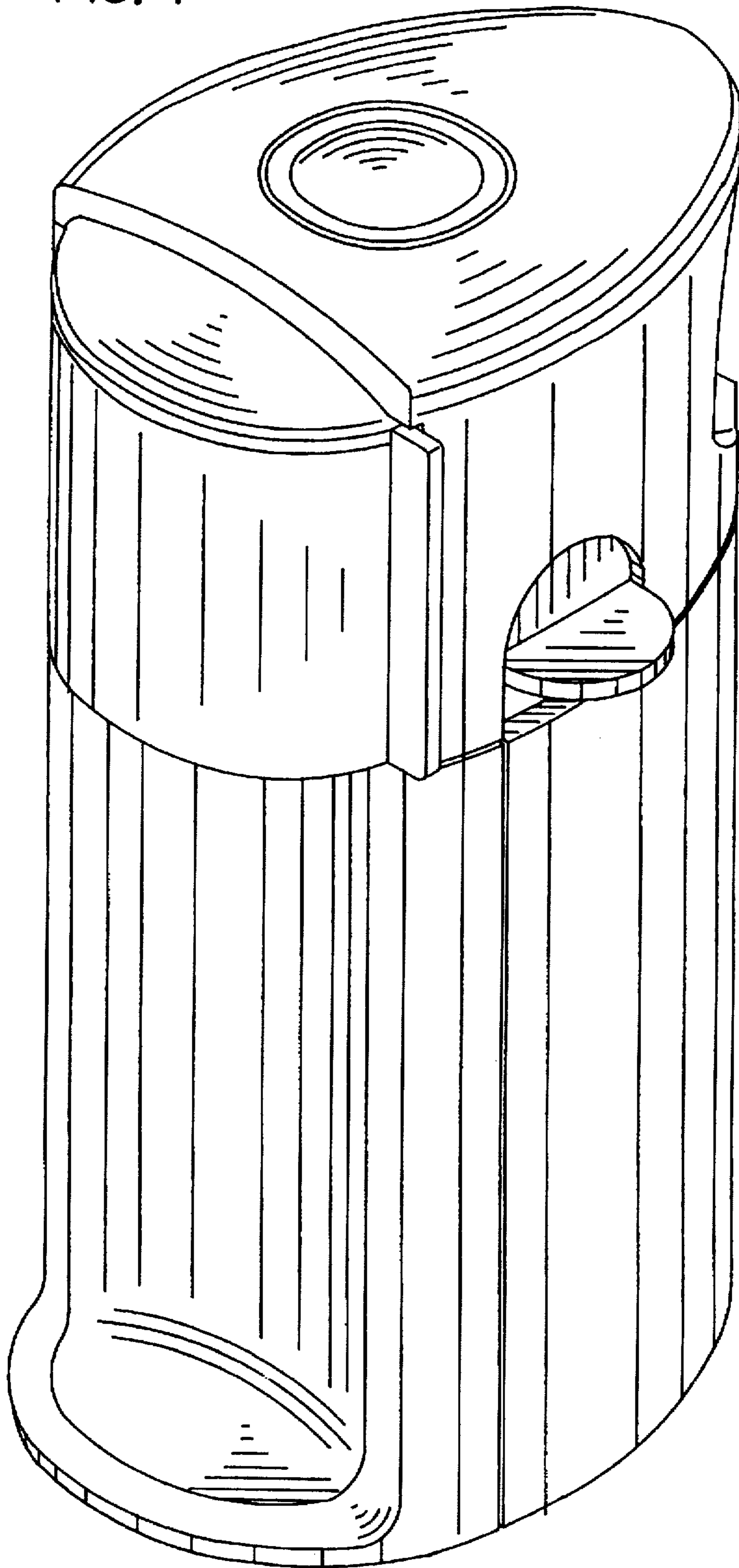

FIG. 1



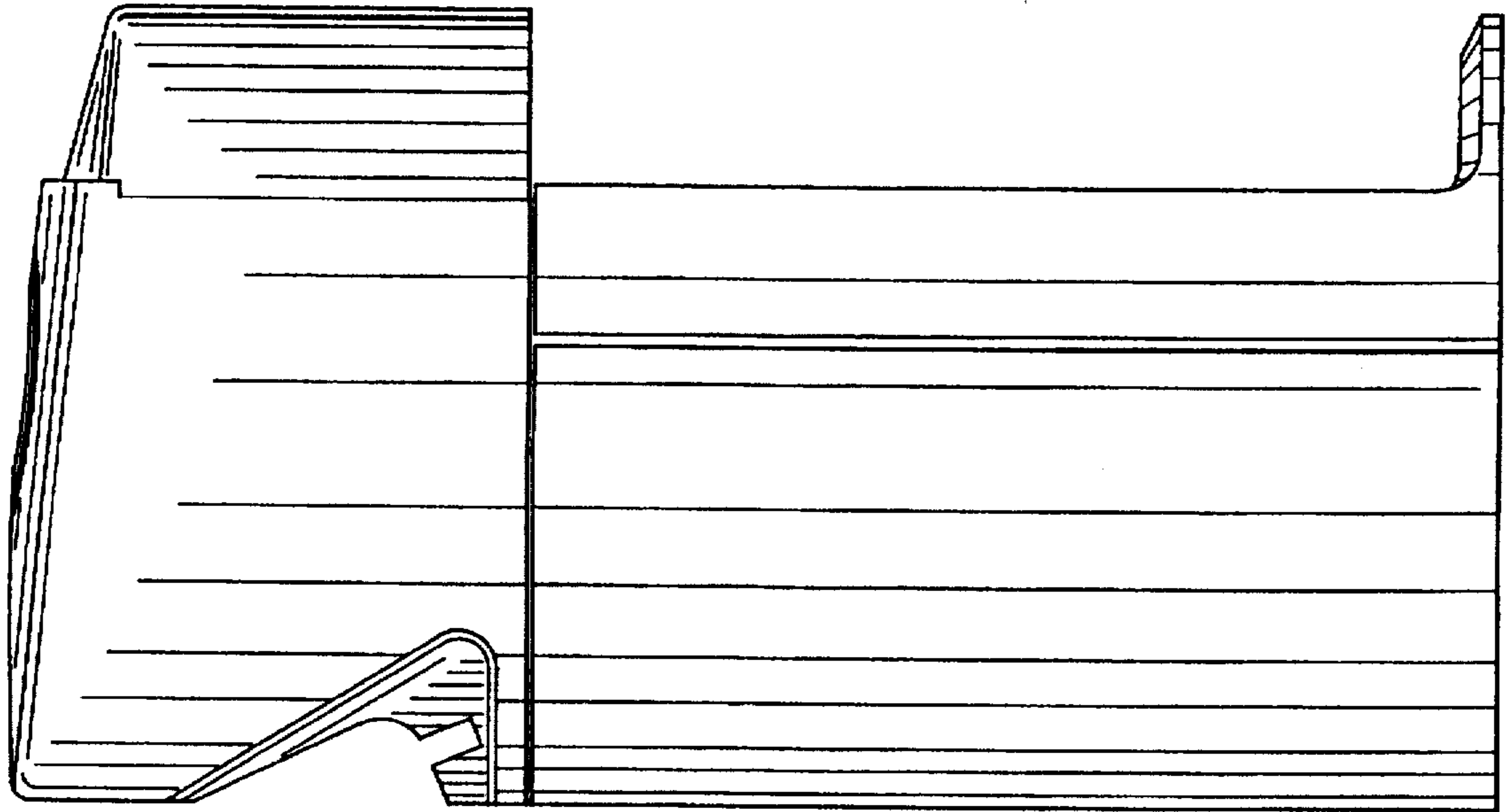

FIG. 3

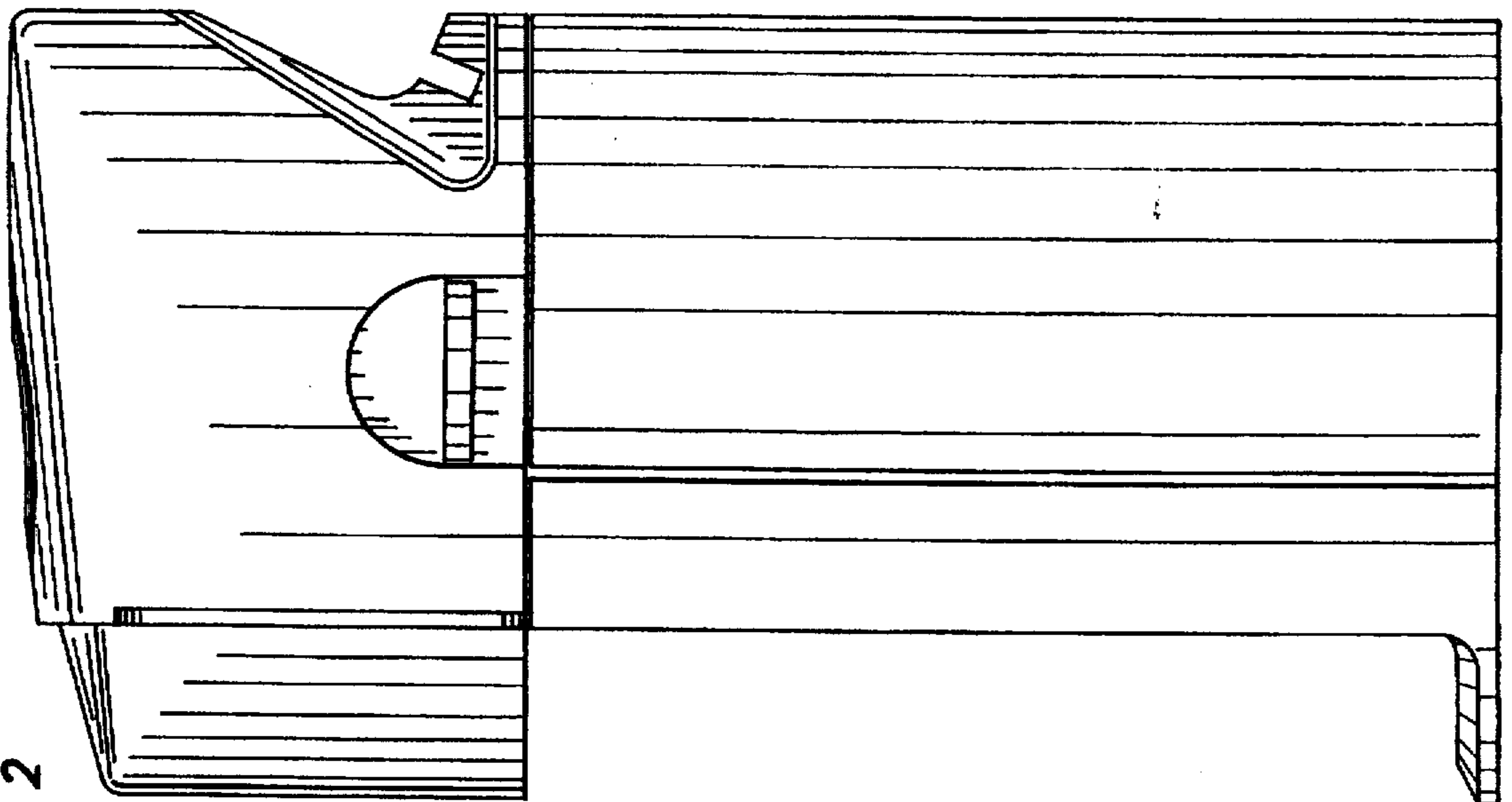
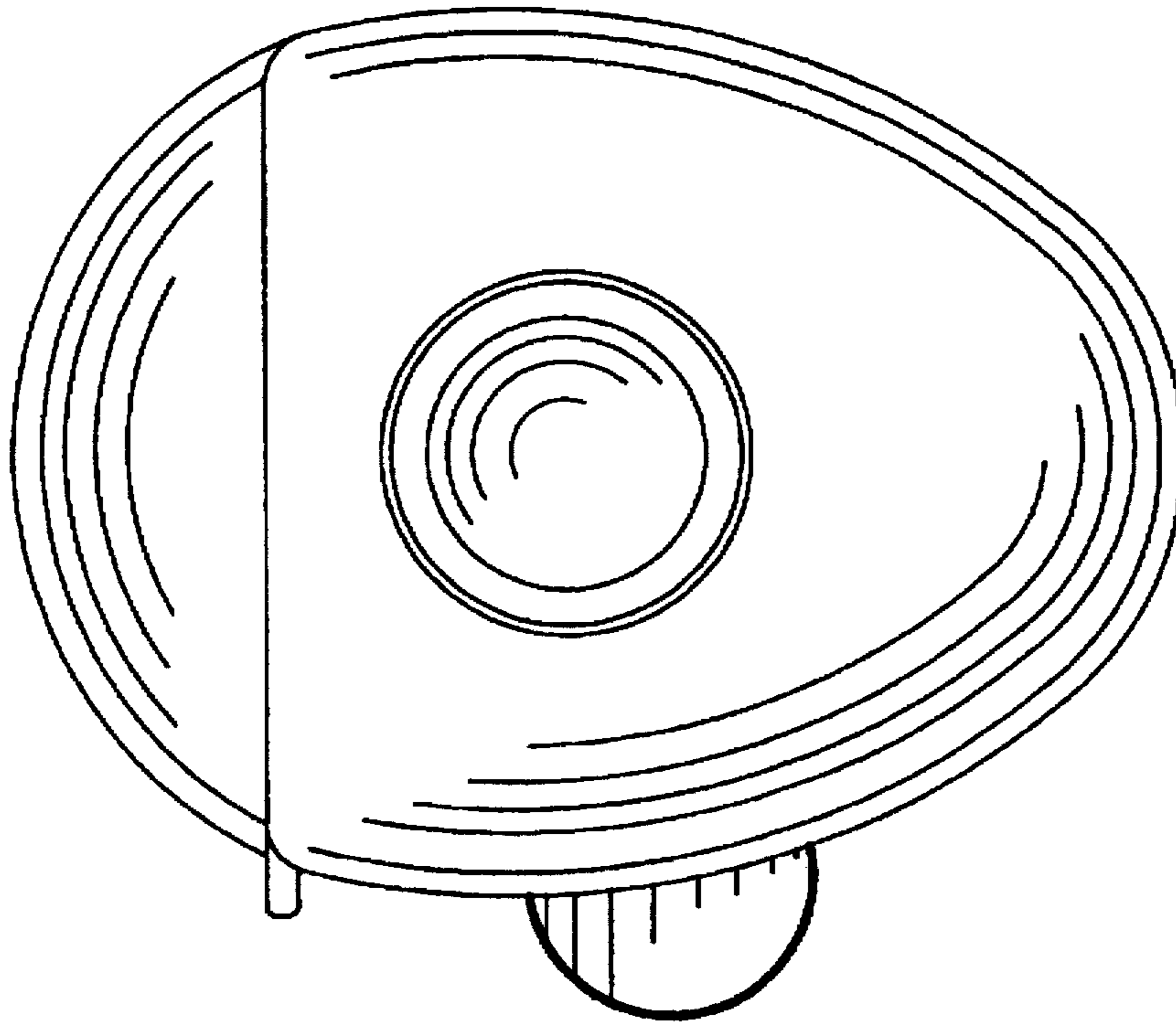

FIG. 2

**FIG. 6**



**FIG. 7**

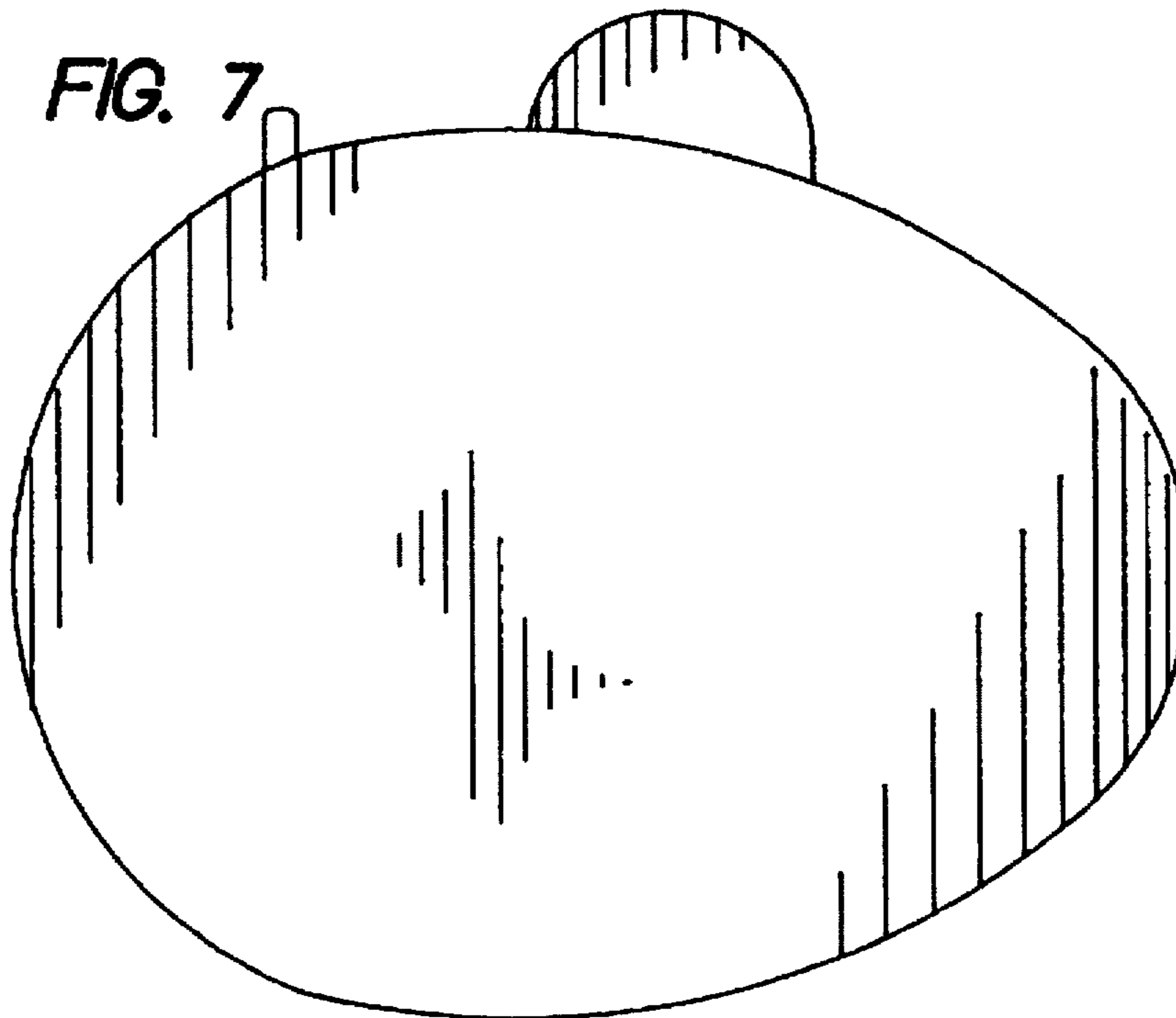

FIG. 4

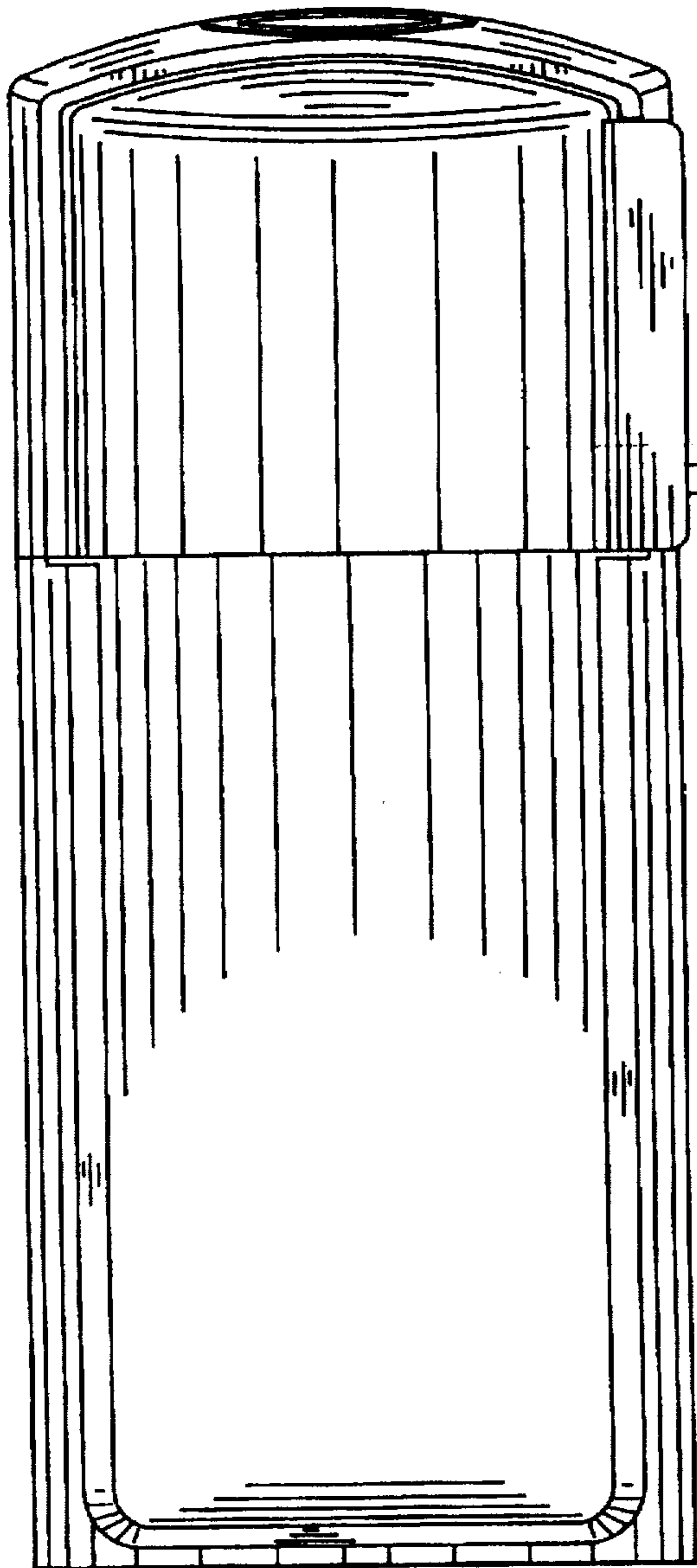

FIG. 5

