

US00D384466S

United States Patent [19]

[11] Patent Number: **Des. 384,466**

Taylor

[45] Date of Patent: ****Sep. 30, 1997**

- [54] **DROP SHOULDER CREEPER WITH T-BAR SUPPORT AND TILTING HEADREST**
- [76] Inventor: **Ken Taylor**, 2621 Atlantic St., Merced, Calif. 95340
- [**] Term: **14 Years**
- [21] Appl. No.: **56,721**
- [22] Filed: **Jul. 8, 1996**
- [51] LOC (6) Cl. **12-02**
- [52] U.S. Cl. **D34/23**
- [58] Field of Search D34/12, 23; 280/32.6, 280/32.5, 79.11

2,780,472	2/1957	Weldon, Sr.	280/32.6
4,570,957	2/1986	Rose	280/32.6
4,721,316	1/1988	Whiteside	280/32.6
4,792,147	12/1988	Wissing	280/32.6
4,875,694	10/1989	Hamrick	280/32.6
4,895,380	1/1990	Brooks et al.	280/32.6
5,108,118	4/1992	Schaevitz	280/32.6
5,174,592	12/1992	Pool	280/32.6
5,195,763	3/1993	Scott et al.	280/32.6
5,213,350	5/1993	Hermanson	280/32.6
5,330,209	7/1994	Pool	280/32.6
5,378,003	1/1995	Burd et al.	280/32.6
5,397,139	3/1995	Simpson et al.	280/32.6
5,472,219	12/1995	Eckstrum	280/32.6
5,527,051	6/1996	Plaza	280/32.6

Primary Examiner—**Kay H. Chin**
 Attorney, Agent, or Firm—**Stein, Pendorf & Van Der Wall**

[56] References Cited

U.S. PATENT DOCUMENTS

D. 230,971	3/1974	Shanklin .	
D. 242,909	1/1977	Miller	D12/31
D. 270,962	10/1983	Martell	D34/23
D. 296,597	7/1988	Adams	D34/23
D. 298,374	11/1988	Hamrick	D34/23
D. 299,076	12/1988	Whiteside	D34/23
D. 301,078	5/1989	Szpot	D34/23
D. 301,791	6/1989	Osborne	D34/23
D. 309,967	8/1990	Fagan	D34/23
D. 319,717	9/1991	Schultz	D34/23
D. 320,484	10/1991	Wallin	D34/23
D. 321,072	10/1991	Bennett et al.	D34/23
D. 321,578	11/1991	Gilbert	D34/23
D. 325,799	4/1992	Chen	D34/23
D. 330,619	10/1992	Gilbert et al.	D34/23
D. 335,733	5/1993	Zimmer	D34/23
D. 351,707	10/1994	Pill	D34/23
D. 354,599	1/1995	Young	D34/23
1,104,398	7/1914	Zimmerman .	
1,769,548	7/1930	Rodin .	
2,154,952	4/1939	Mahloch .	
2,210,585	8/1940	Hulbert .	
2,288,568	6/1942	Holmes .	
2,487,706	11/1949	Happ	280/61.5
2,509,934	5/1950	Murray	280/61.5
2,595,783	5/1952	Griffin	280/61.5

[57] CLAIM

The ornamental design for a drop shoulder creeper with T-bar support and tilting headrest, as shown and described.

DESCRIPTION

FIG. 1 is a front elevated view of the drop shoulder creeper with T-bar support and tilting headrest;
 FIG. 2 is a front view of the drop shoulder creeper with T-bar support and tilting headrest;
 FIG. 3 is a rear view of the drop shoulder creeper with T-bar support and tilting headrest;
 FIG. 4 is a side view of the drop shoulder creeper with T-bar support and tilting headrest;
 FIG. 5 is a mirror side view of the drop shoulder creeper with T-bar support and tilting headrest as shown in FIG. 4;
 FIG. 6 is a top view of the drop shoulder creeper with T-bar support and tilting headrest;
 FIG. 7 is a bottom view of the drop shoulder creeper with T-bar support and tilting headrest; and,
 FIG. 8 is a side view of the drop shoulder creeper with T-bar support and tilting headrest, illustrating the tilting headrest in a tilted position.

1 Claim, 6 Drawing Sheets

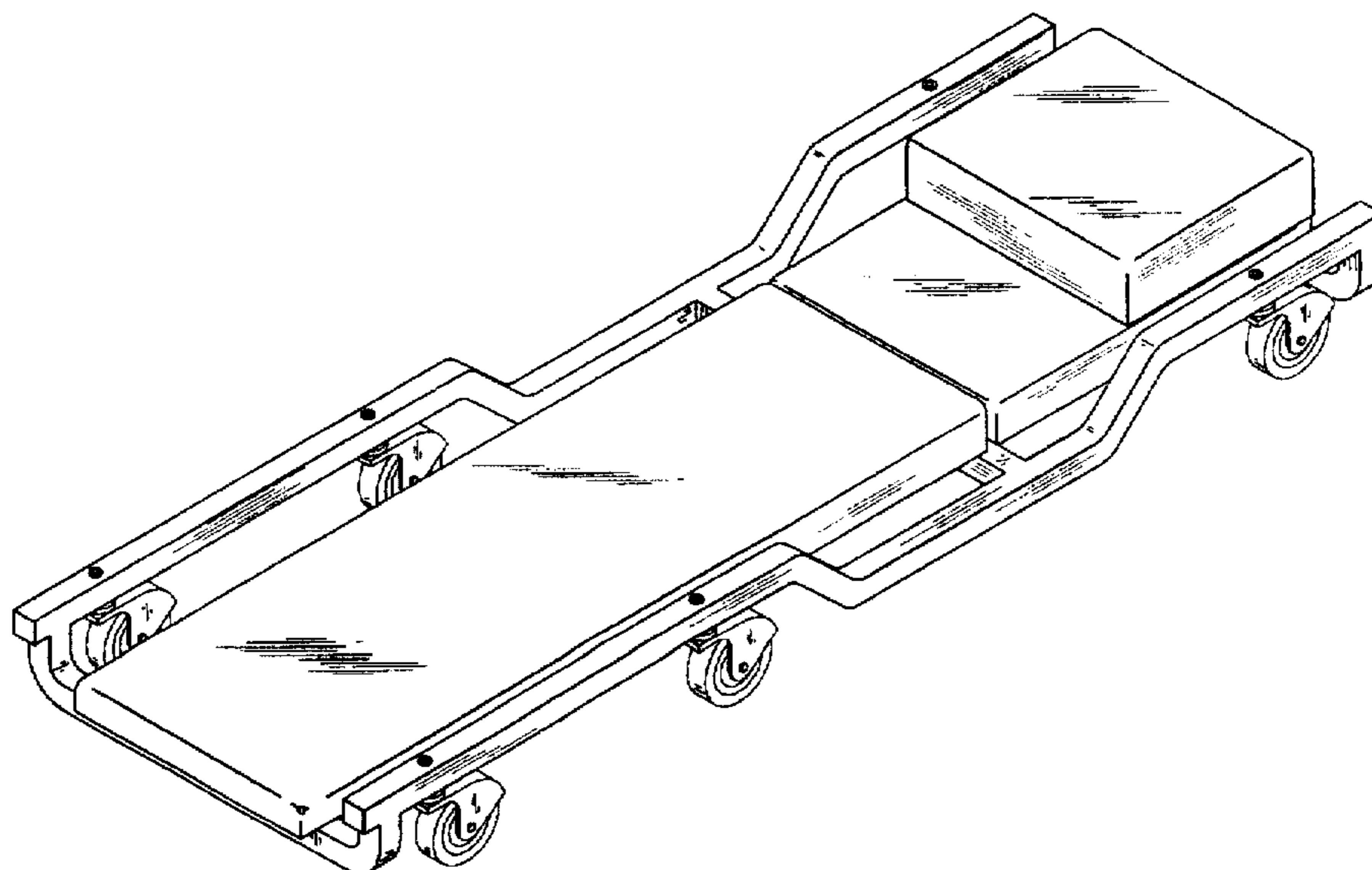

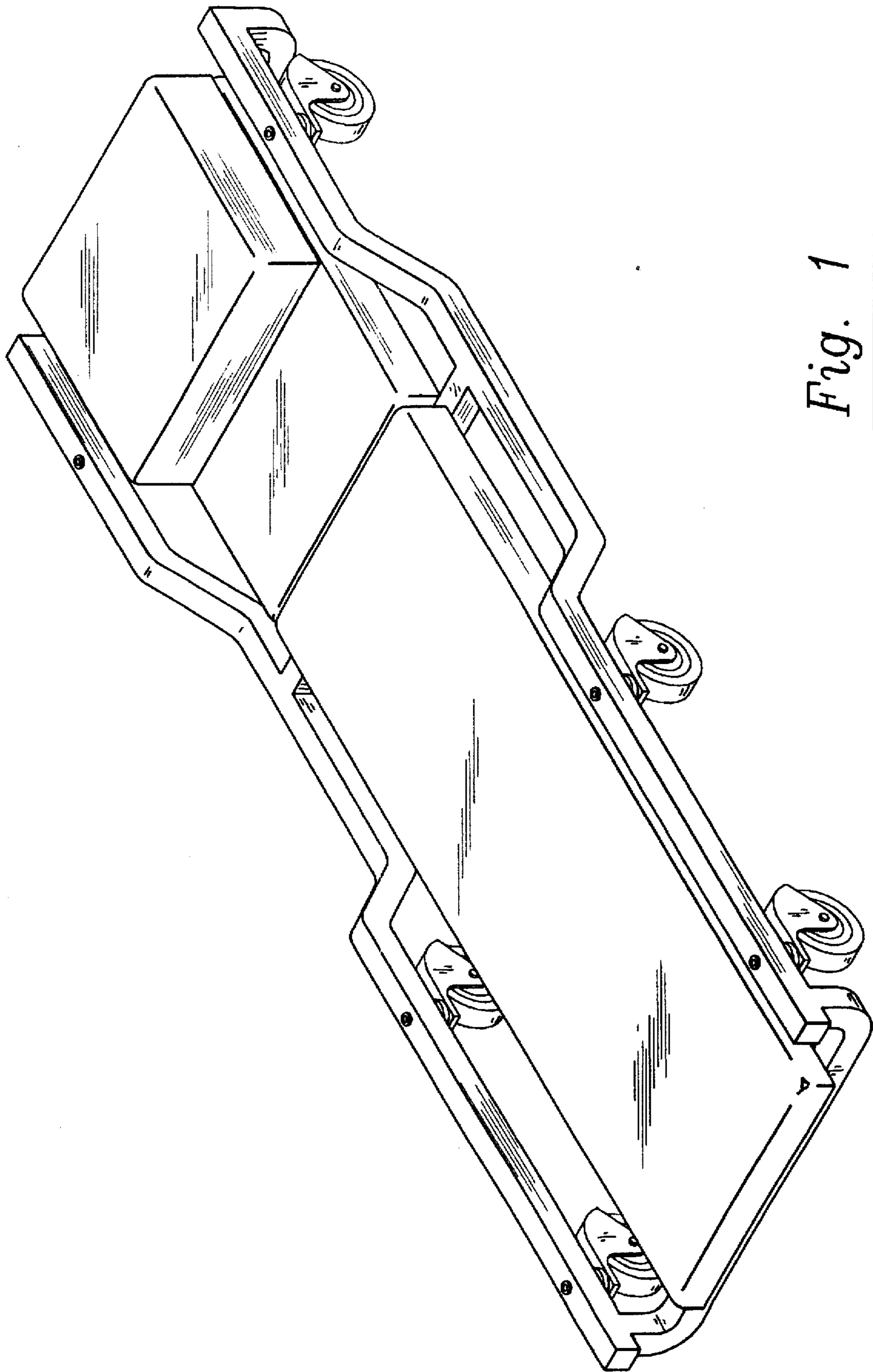

Fig. 1

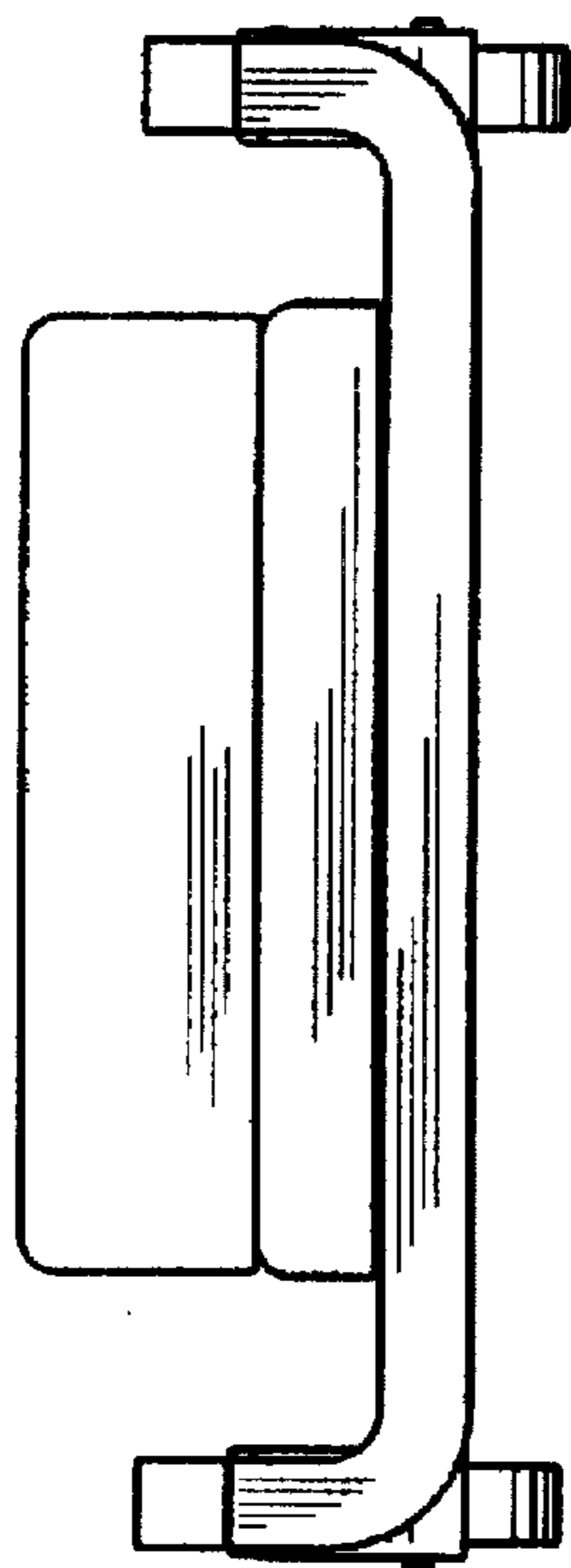

Fig. 3

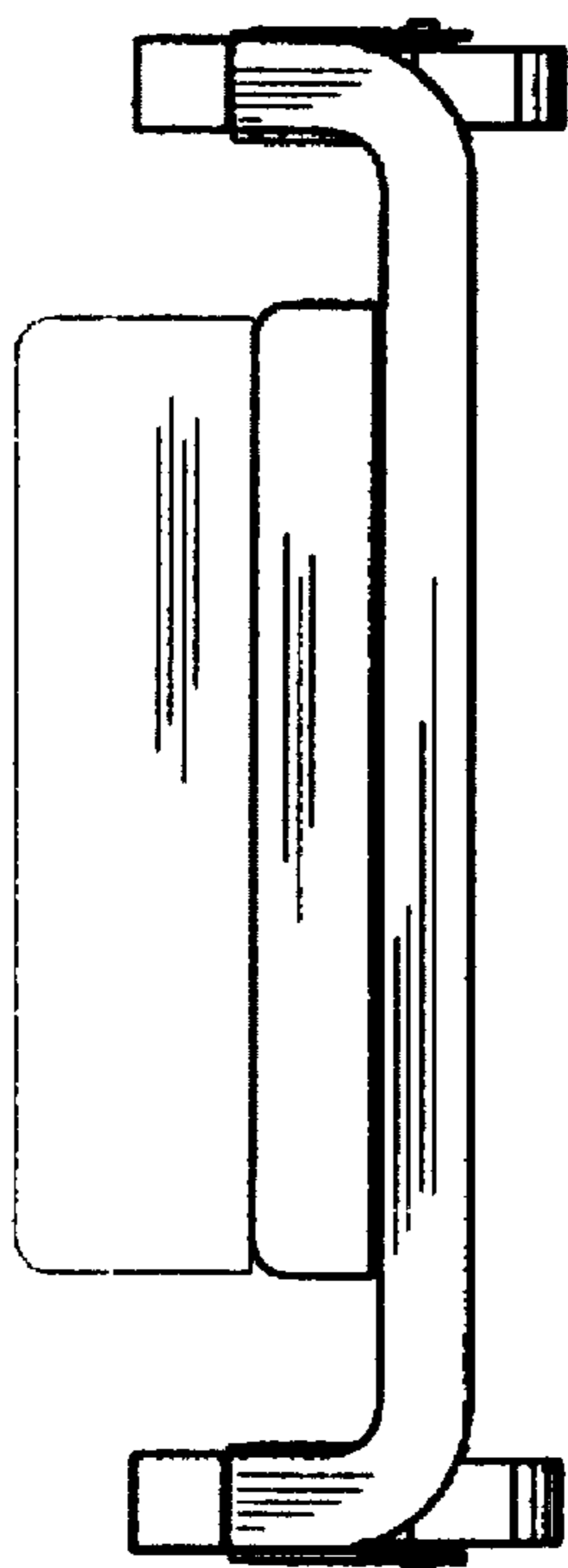

Fig. 2

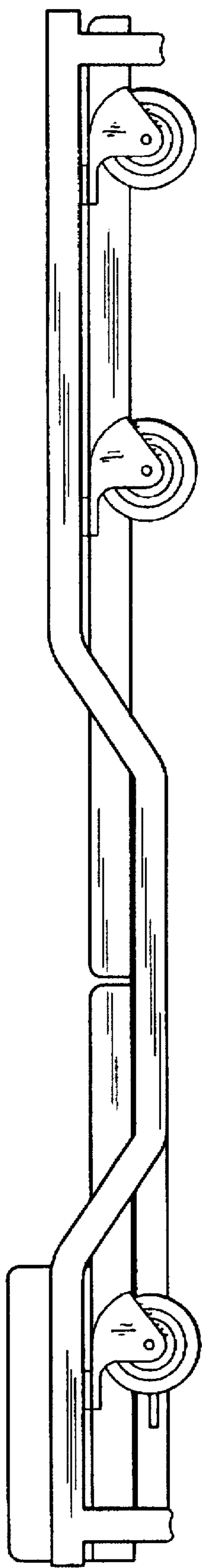

Fig. 4

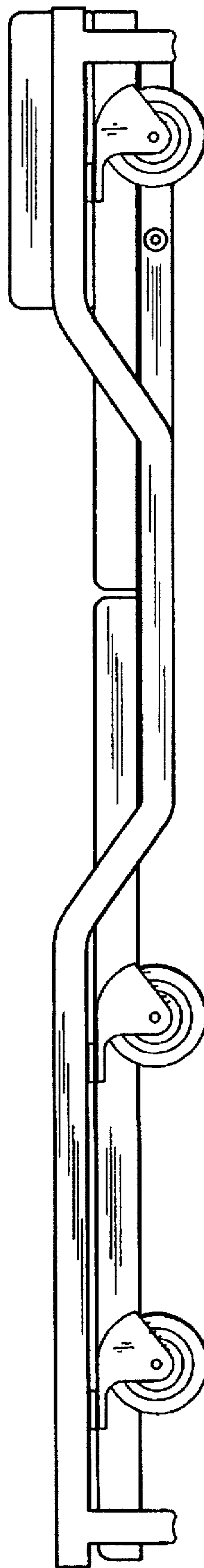

Fig. 5

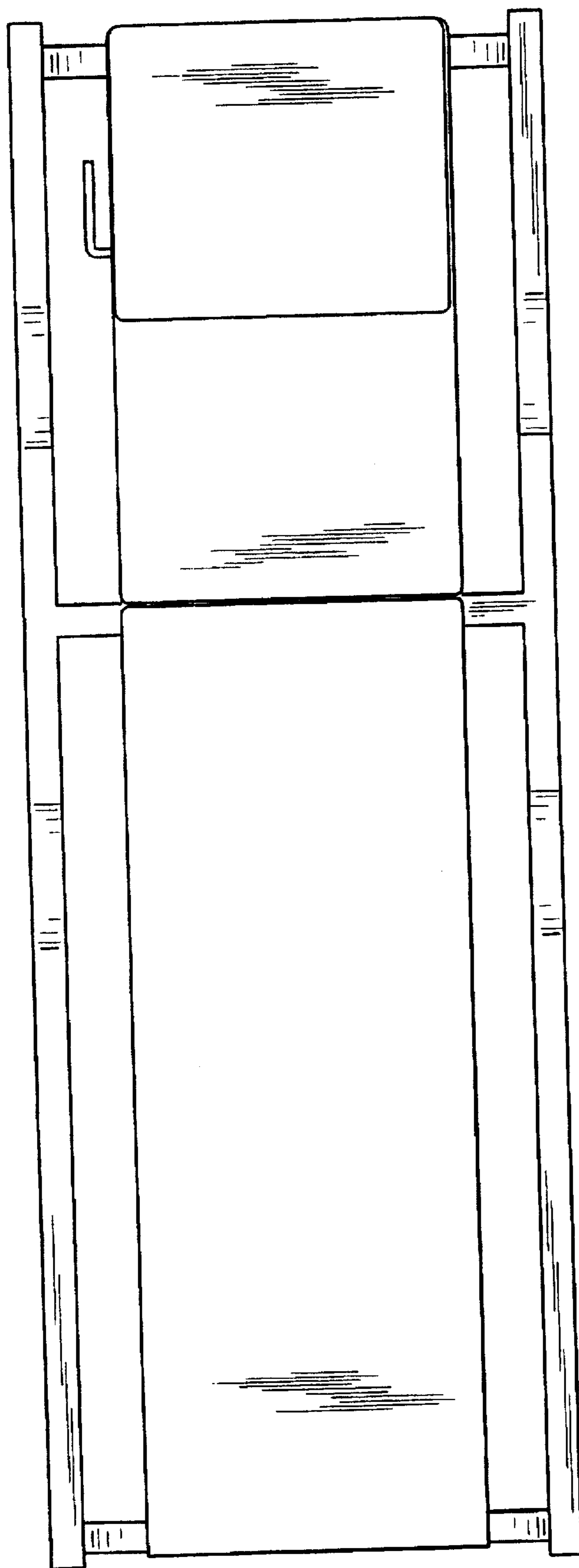

Fig. 6

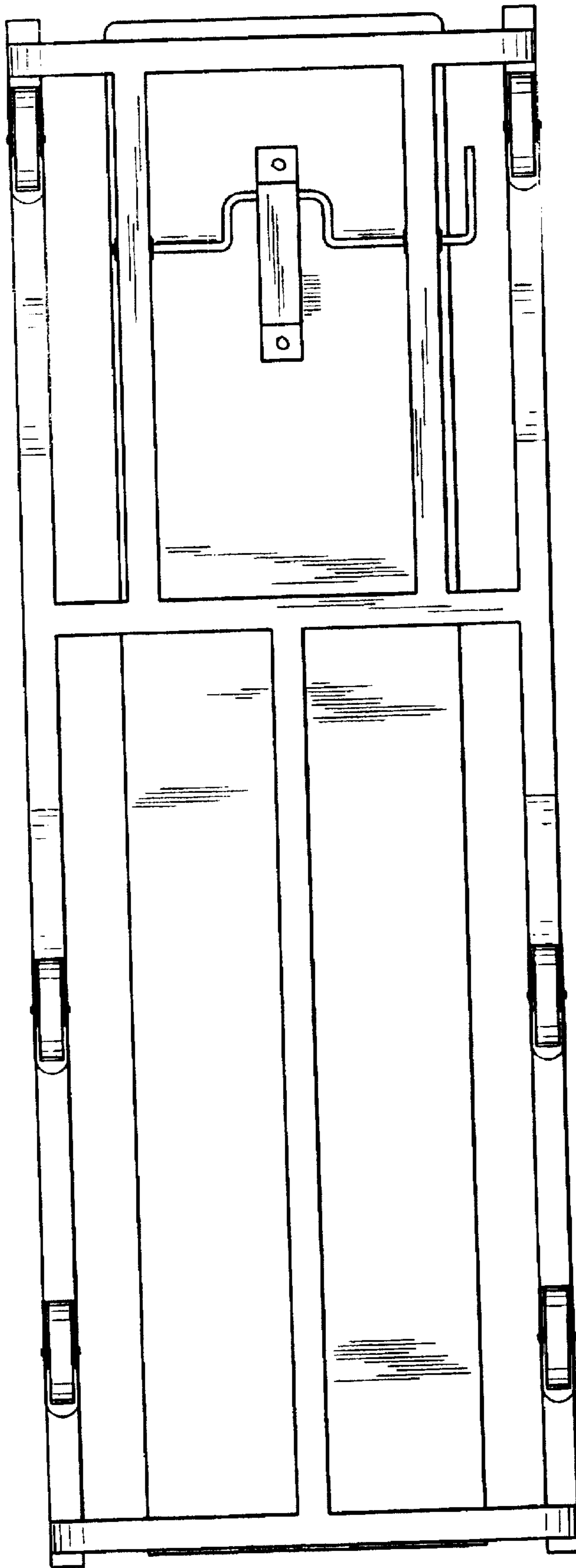

Fig. 7

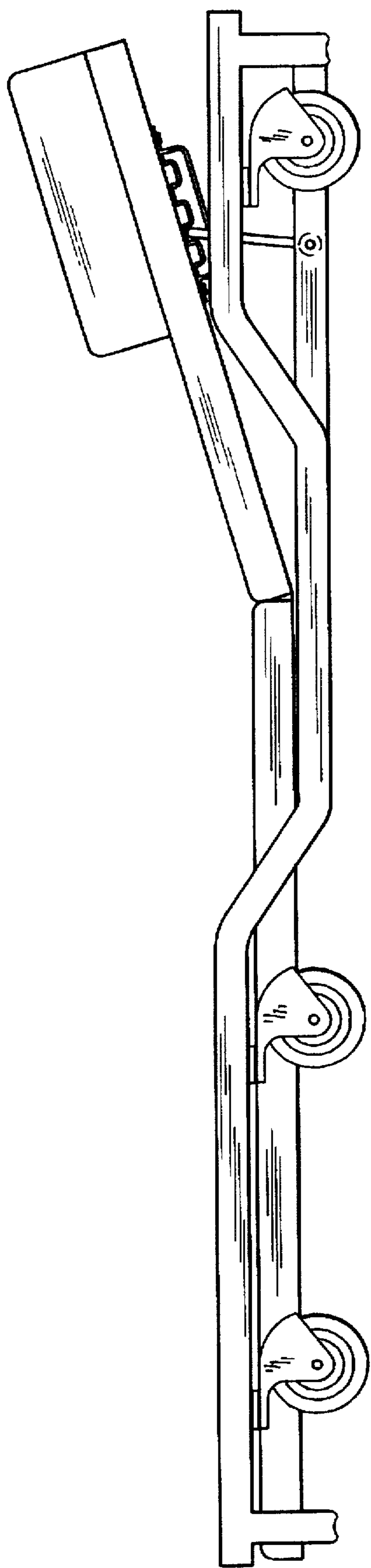

Fig. 8