



US00D384459S

# United States Patent [19]

Eisenman

[11] Patent Number: Des. 384,459

[45] Date of Patent: \*\*Sep. 30, 1997

[54] CLIP FOR USE IN LAUNDERING SOCKS

[76] Inventor: Kevin Eisenman, 134 N. Ellsworth St., Allentown, Pa. 18103

[\*\*] Term: 14 Years

[21] Appl. No.: 55,006

[22] Filed: May 28, 1996

[51] LOC (6) Cl. .... 07-05

[52] U.S. Cl. .... D32/61; D8/395; D28/39

[58] Field of Search .... D32/61-65; D28/39-42; D8/394, 395; 140/82, 83; 24/455, 3.1, 570; 223/90, 91, DIG. 2

D. 312,773	12/1990	Salinas	.....	D28/39
D. 367,744	3/1996	White	.....	D32/61
2,481,791	9/1949	Spokus	.....	D28/42
2,572,643	10/1951	Mauil	.....	D32/63

Primary Examiner—A. Hugo Word  
Assistant Examiner—Robin V. Taylor

### [57] CLAIM

The ornamental design for a clip for use in laundering socks, as shown and described.

### DESCRIPTION

FIG. 1 is a front elevational view of the clip for use in laundering socks showing my new design;  
FIG. 2 is a rear elevational view thereof;  
FIG. 3 is a right view thereof;  
FIG. 4 is a left view thereof;  
FIG. 5 is a top plan view thereof;  
FIG. 6 is a bottom plan view thereof; and,  
FIG. 7 is an isometric view thereof.

1 Claim, 3 Drawing Sheets

### [56] References Cited

#### U.S. PATENT DOCUMENTS

D. 32,357	3/1900	Herald	.....	D28/39
D. 199,310	10/1964	Rizzuto	.....	D32/61
D. 298,976	12/1988	Moore	.....	D32/61
D. 299,008	12/1988	Naslund	.....	D8/395
D. 311,078	10/1990	Holladay et al.	.....	D32/61

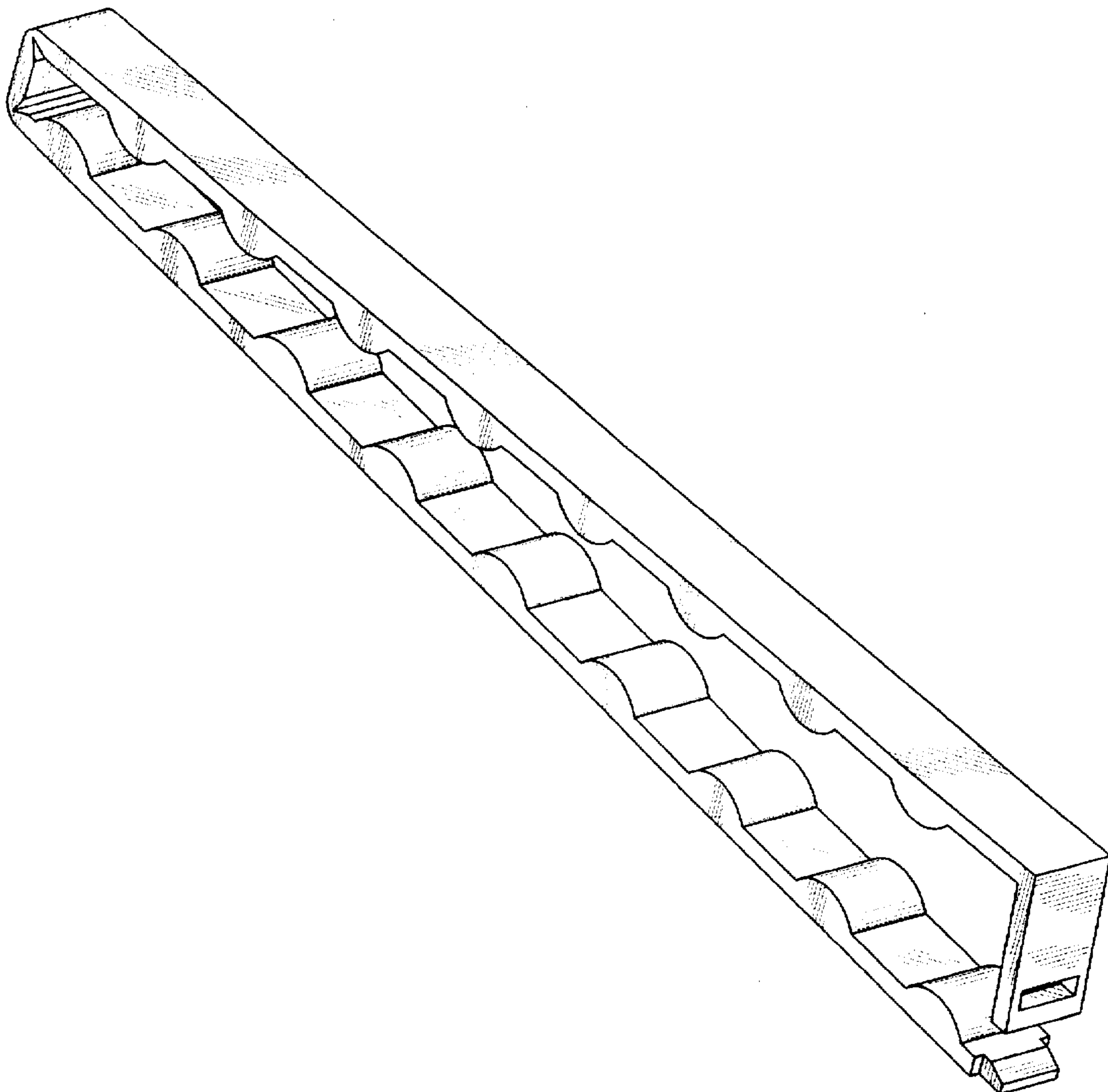

FIG. 1

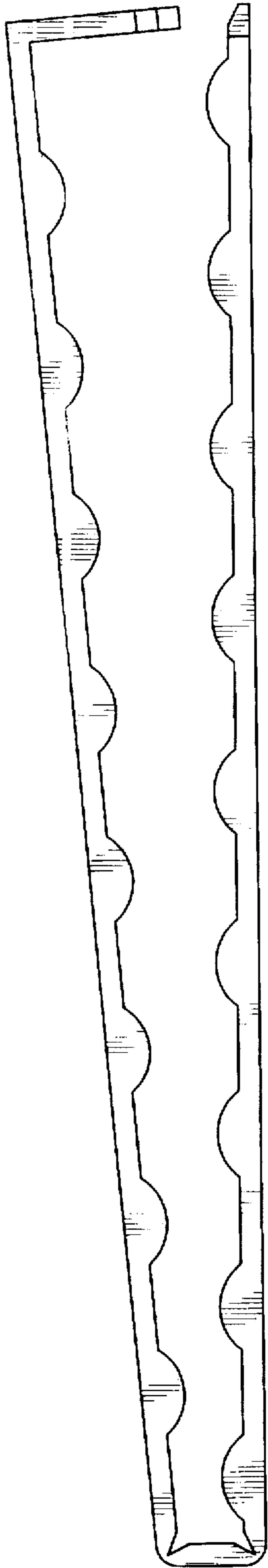

FIG. 2

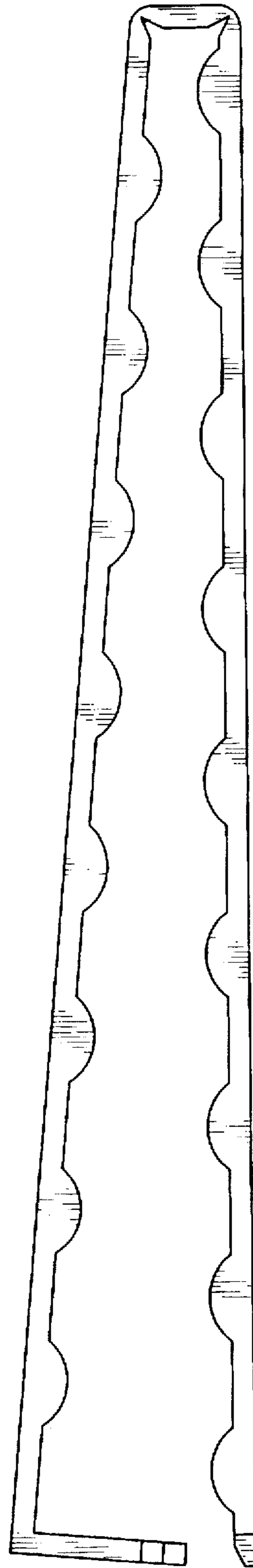

FIG. 3

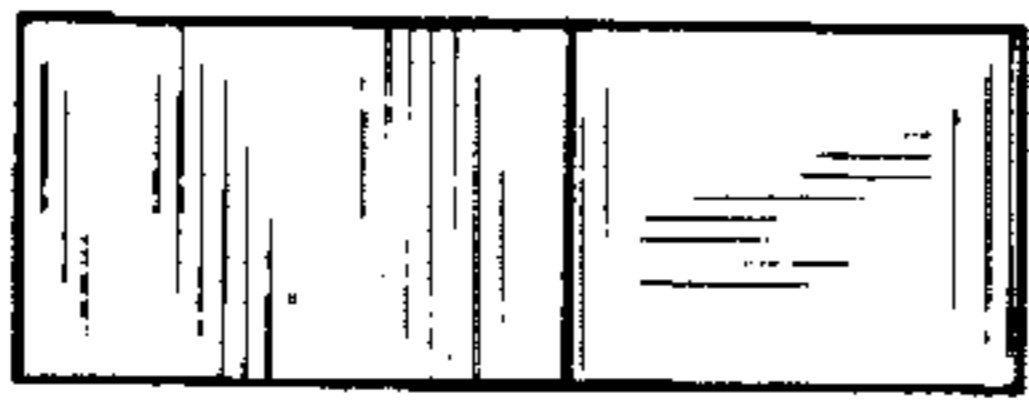

FIG. 4

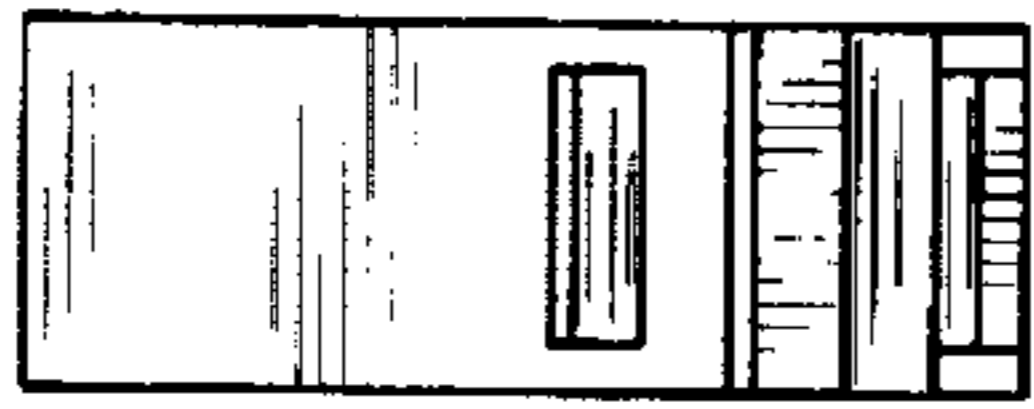

FIG. 5

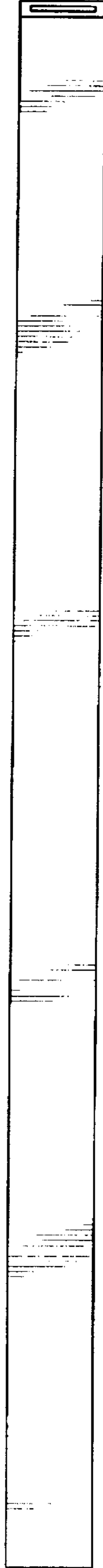

FIG. 6

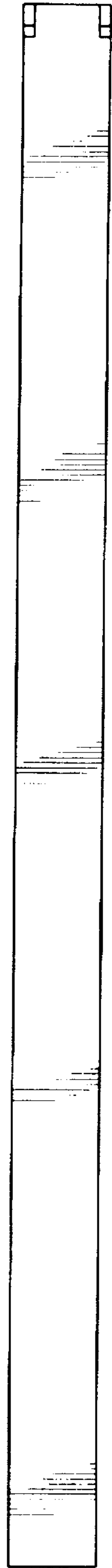

FIG. 7

