

US00D384339S

United States Patent [19]

Tochishita

[11] Patent Number: Des. 384,339

[45] Date of Patent: **Sep. 30, 1997

[54] **PORTABLE LAPTOP COMPUTER**

[75] Inventor: **Masaru Tochishita**, Osaka, Japan

[73] Assignee: **Matsushita Electric Industrial Co., Ltd.**, Osaka, Japan

[**] Term: **14 Years**

D. 364,387 11/1995 Chiba et al. D14/106
 D. 365,336 12/1995 Vossoughi et al. D14/106
 D. 365,337 12/1995 Tsiang et al. D14/106
 D. 367,046 2/1996 Haraga et al. D14/106

Primary Examiner—Freda Nunn
Attorney, Agent, or Firm—Sughrue, Mion, Zinn, Macpeak & Seas

[21] Appl. No.: **56,271**

[22] Filed: **Jun. 18, 1996**

[57] CLAIM

The ornamental design for a portable laptop computer, as shown and described.

[30] Foreign Application Priority Data

Dec. 20, 1995 [JP] Japan 7-38493

DESCRIPTION

[51] **LOC (6) Cl.** **14-02**

[52] **U.S. Cl.** **D14/106**

[58] **Field of Search** D14/100, 101, D14/106, 113, 115; D18/1, 7; 235/145 A, 145 R; 341/22, 23; 345/104, 156, 168, 173; 361/680-686; 364/708.1; 400/486, 489

FIG. 1 is a perspective view of the top, front and right side of a portable laptop computer showing my new design;
 FIG. 2 is a front elevational view thereof;
 FIG. 3 is a rear elevational view thereof;
 FIG. 4 is a left side elevational view thereof;
 FIG. 5 is a right side elevational view thereof;
 FIG. 6 is a top plan view thereof;
 FIG. 7 is a bottom plan view thereof; and,
 FIG. 8 is a view similar to FIG. 1 with the top closed.

[56] References Cited

U.S. PATENT DOCUMENTS

D. 363,471 10/1995 Shima et al. D14/106

1 Claim, 6 Drawing Sheets

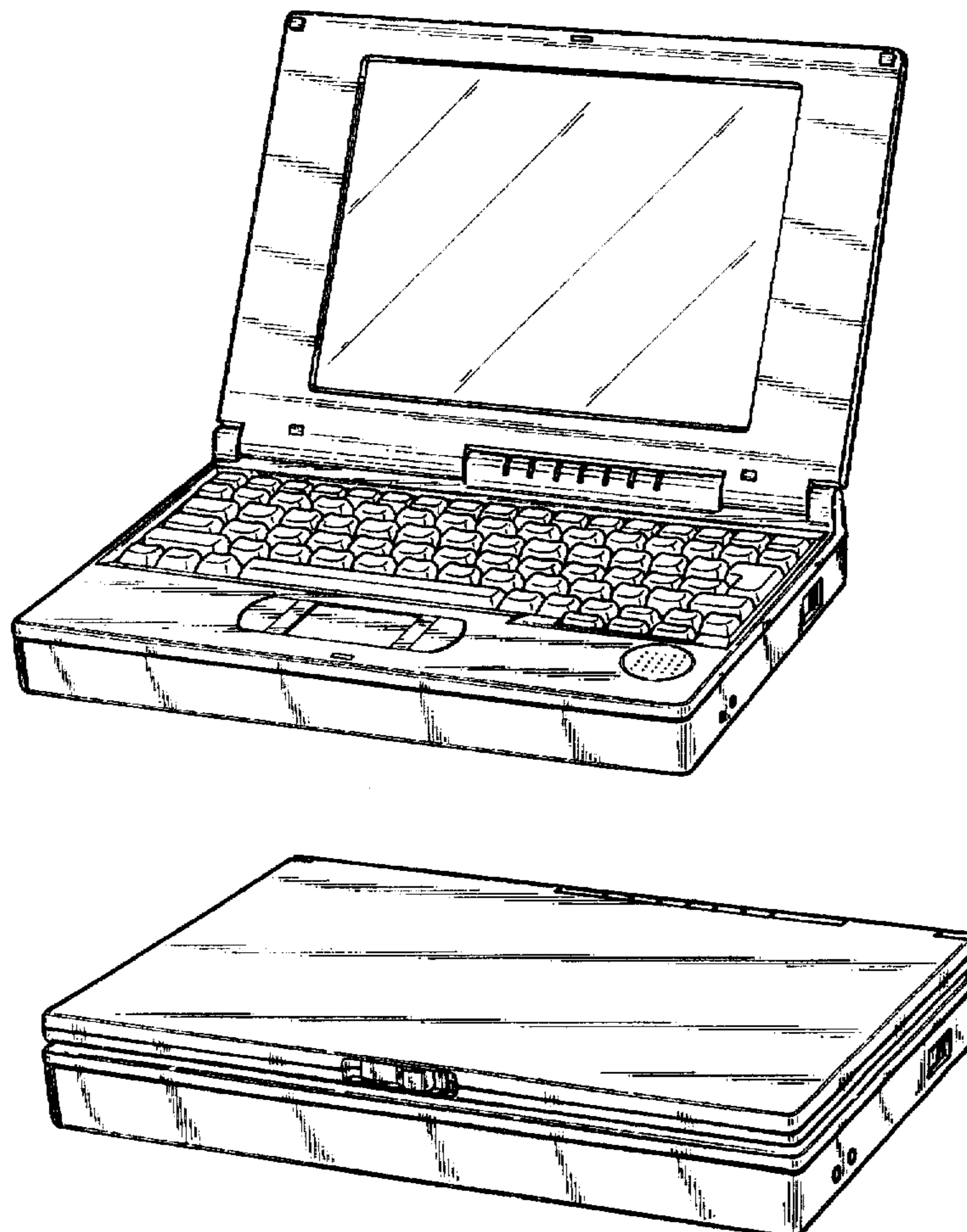

Fig. 1

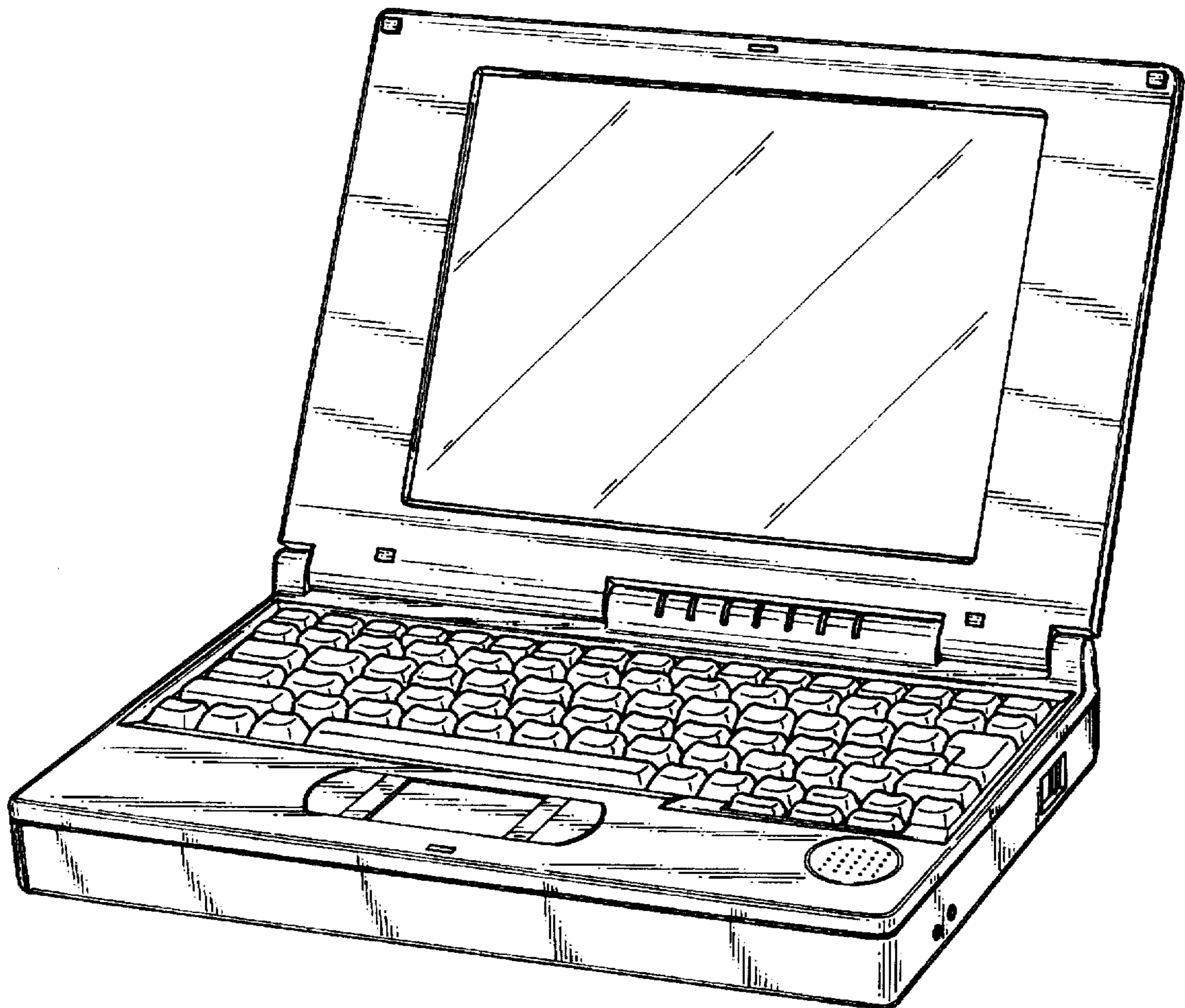

Fig. 2

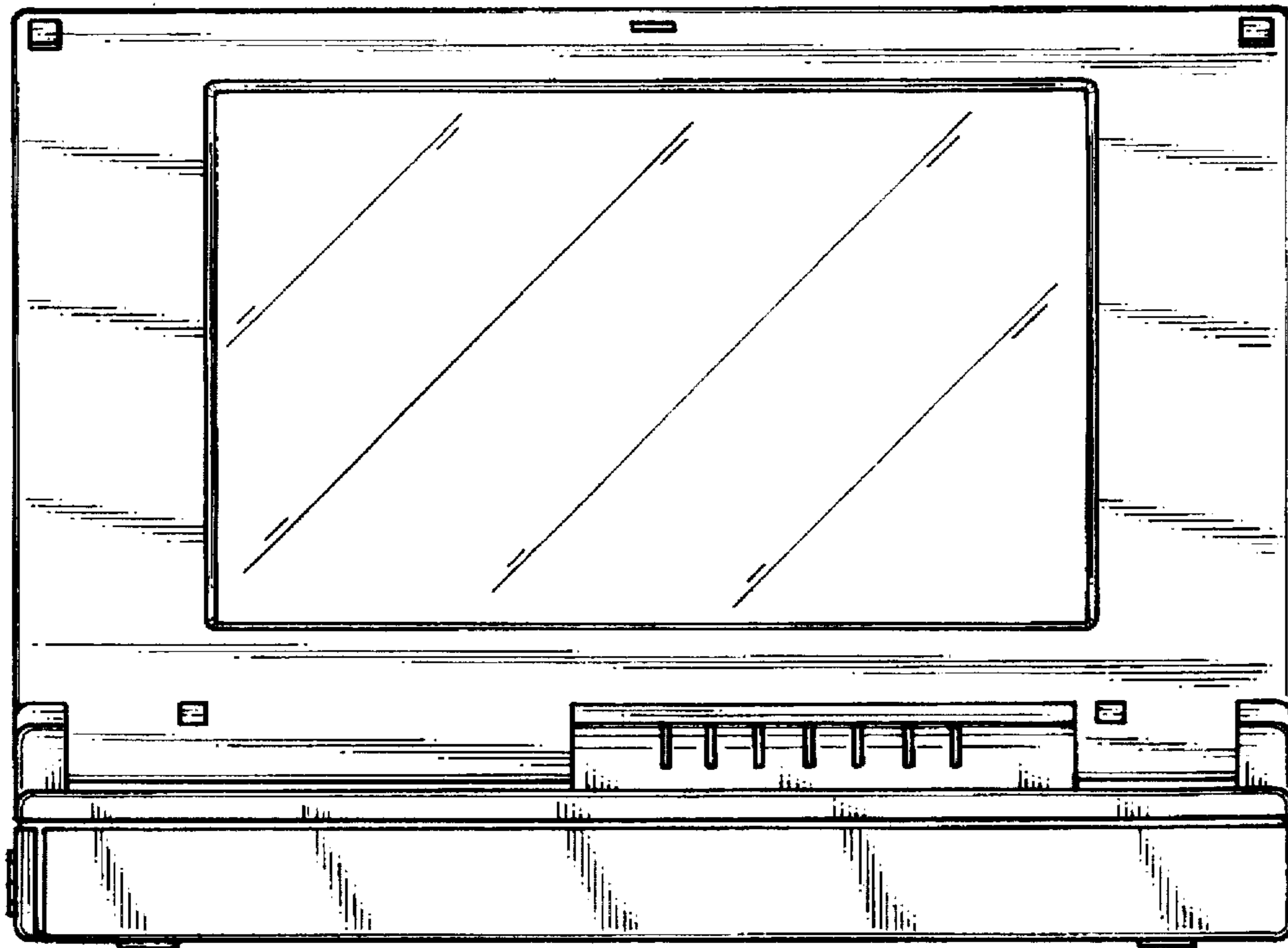

Fig. 3

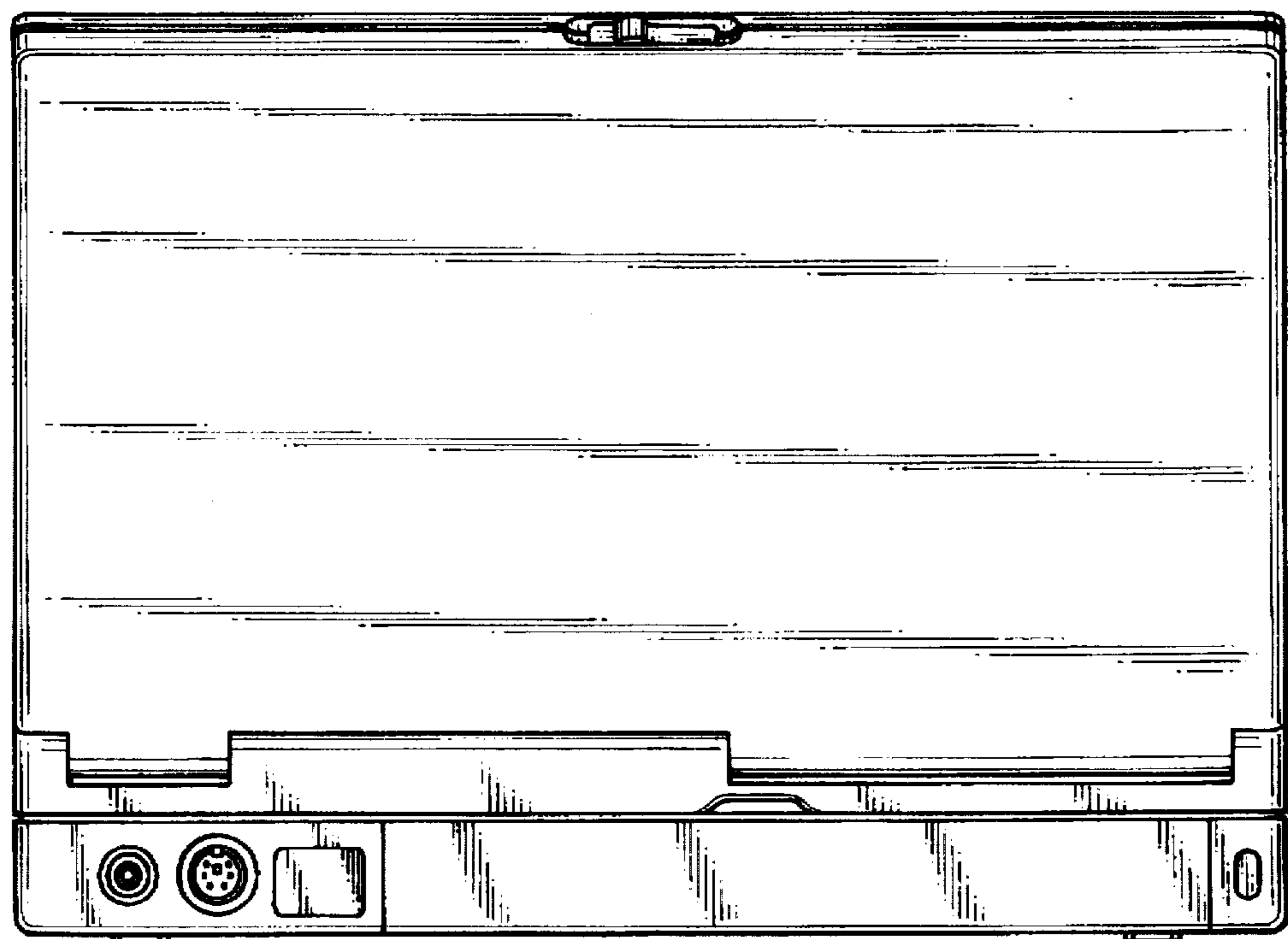

Fig. 4

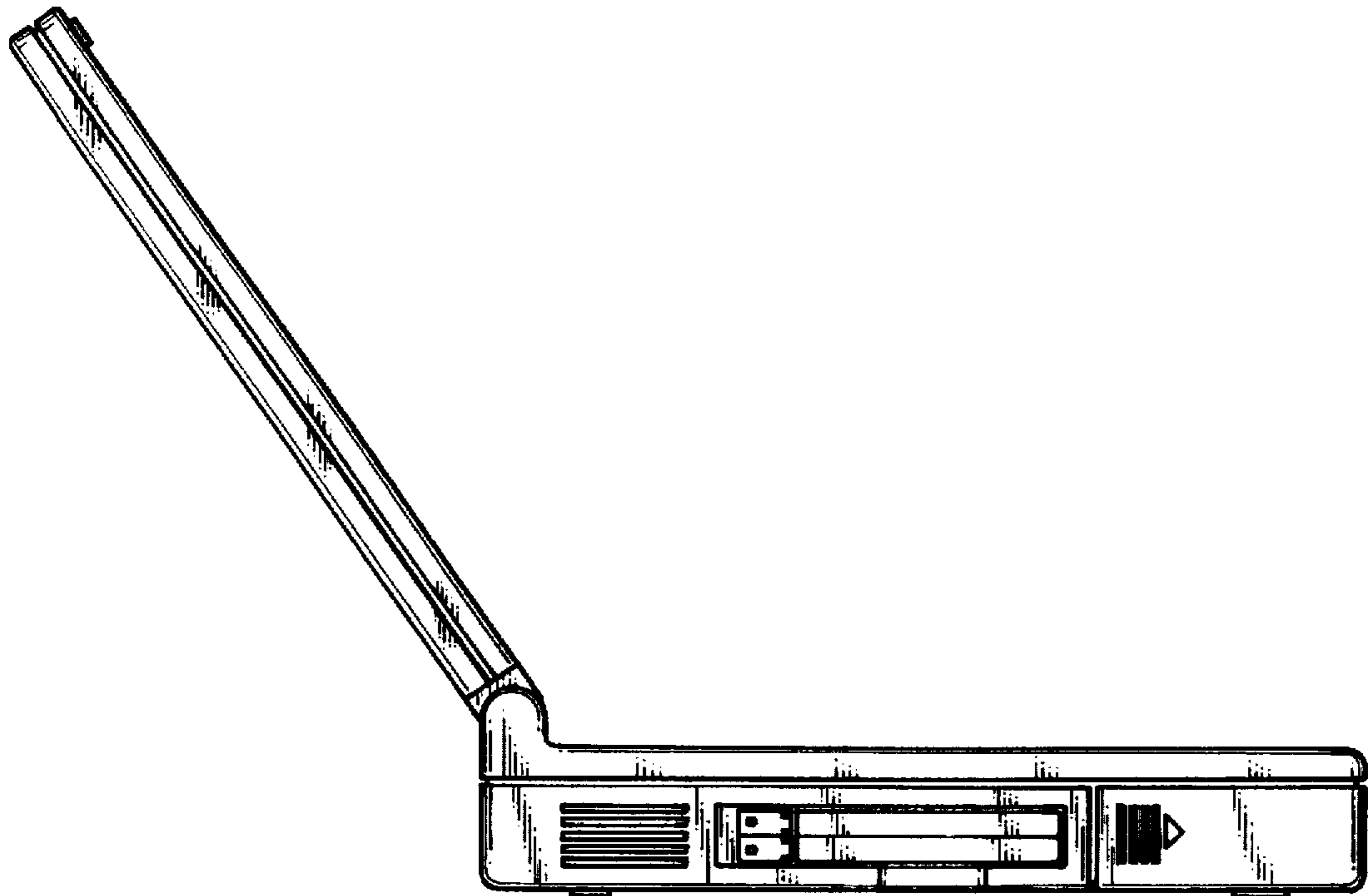

Fig. 5

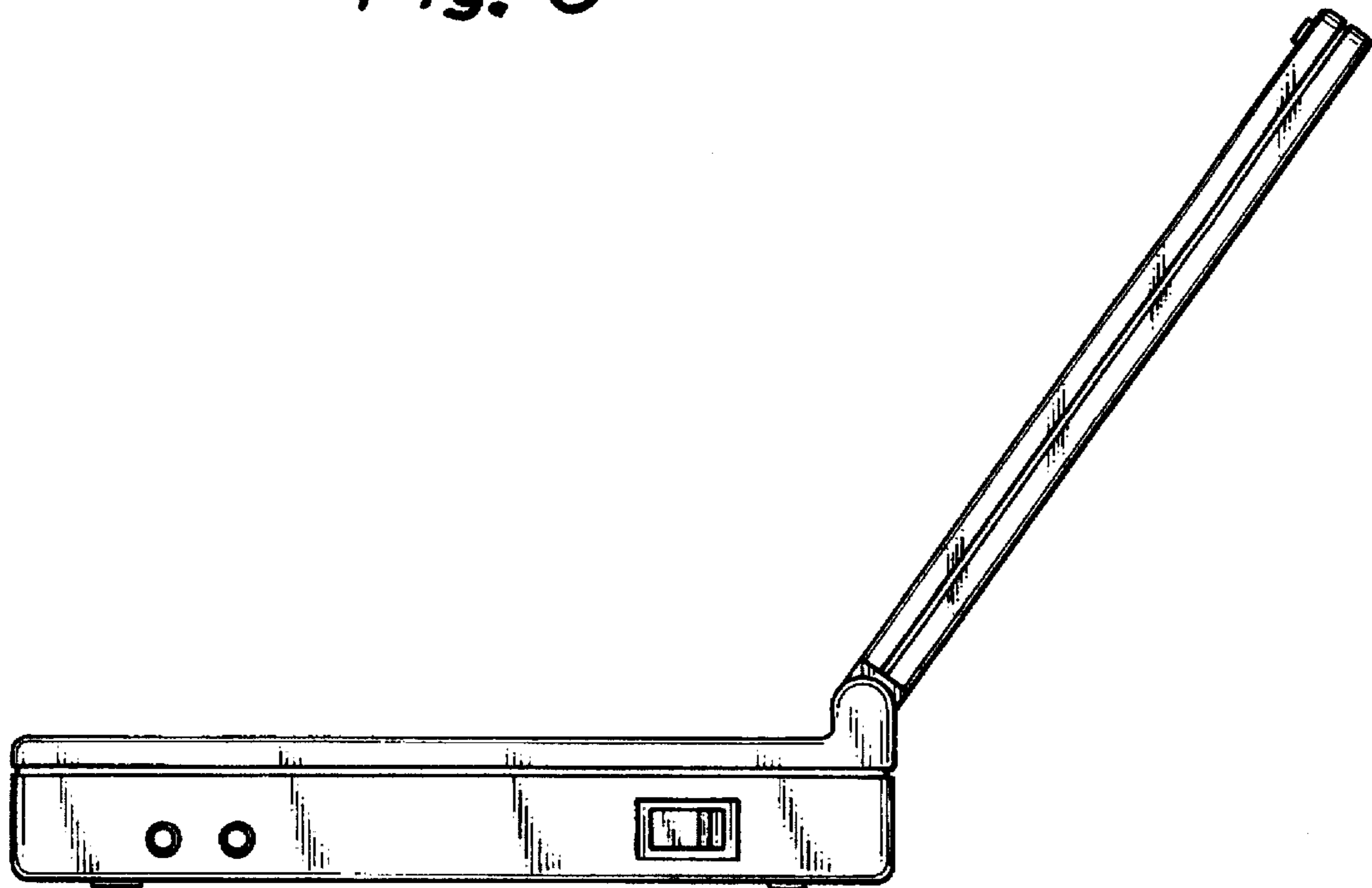

Fig. 6

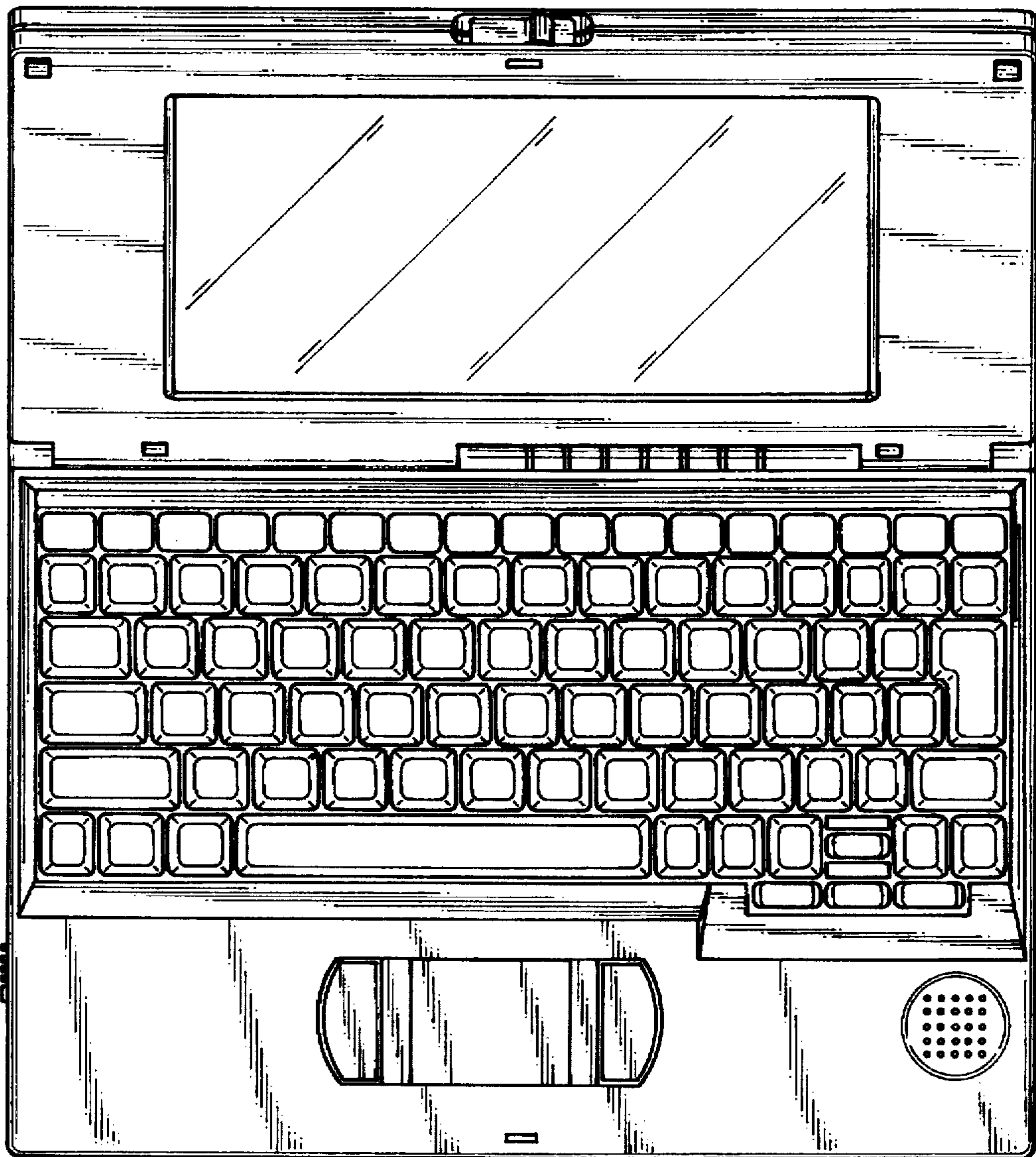

Fig. 7

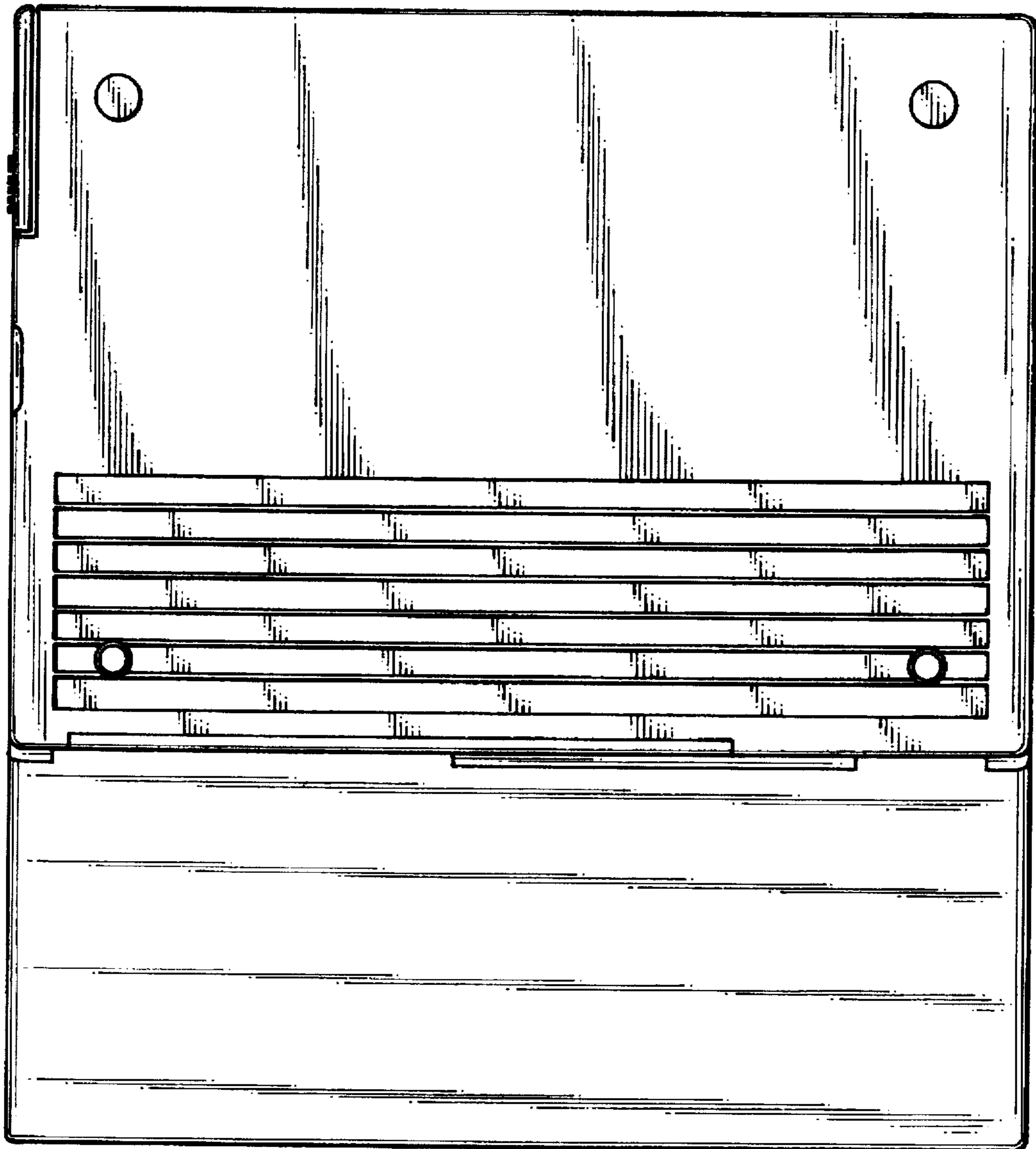

Fig. 8

