



US00D384329S

United States Patent [19]
Kammersgard et al.

[11] **Patent Number: Des. 384,329**
[45] **Date of Patent: **Sep. 30, 1997**

[54] **FLEXIBLE JUMPER**

[75] **Inventors: Dana W. Kammersgard, Vista; Angus R. Colson, Jr., Jamul; Cory Echito, San Diego, all of Calif.**

[73] **Assignee: Artecon, Carlsbad, Calif.**

[**] **Term: 14 Years**

[21] **Appl. No.: 47,800**

[22] **Filed: Oct. 27, 1995**

Related U.S. Application Data

[60] **Continuation of Ser. No. 40,142, Jun. 12, 1995, Pat. No. Des. 375,724, which is a division of Ser. No. 28,436, Sep. 15, 1994, abandoned.**

[51] **LOC (6) Cl. 13-03**

[52] **U.S. Cl. D13/146; D13/145**

[58] **Field of Search D13/146, 147, D13/145; 439/507, 509, 655, 246, 247, 460**

[56] **References Cited**

U.S. PATENT DOCUMENTS

D. 317,291	6/1991	Esslinger	D13/133
D. 356,295	3/1995	Shoda et al.	D13/146
4,272,148	6/1981	Knack, Jr.	439/455
4,950,178	8/1990	Harvey et al.	439/507
5,044,984	9/1991	Mosser et al.	439/569 X
5,080,609	1/1992	Fabian et al.	439/540

OTHER PUBLICATIONS

Connectors on pp. 126 and 127 of *Global Computer Supplies* Nov. 1993 catalog.

Connectors on p. 65 of *MCM Electronics Catalog No.27*, Summer 1991.

Connectors on p. 68 of *MCM Electronics Catalog No.27*, Summer 1991.

Primary Examiner—Joel Sincavage

Attorney, Agent, or Firm—John J. Murphey; Murphey Law Offices

[57] **CLAIM**

The inventors claim the ornamental design of the flexible jumper, as shown in the eight figures and described.

DESCRIPTION

FIG. 1 is a left side view of the flexible jumper in its straightened configuration;

FIG. 2 is a top view of the straightened flexible jumper showing our new design;

FIG. 3 is a right side view of our new design;

FIG. 4 is a bottom view of the straightened flexible jumper showing our new design;

FIG. 5 is one end view of our new design showing the female end of the flexible jumper;

FIG. 6 is a trimetric view of our flexible jumper in its curved, mostly used configuration;

FIG. 7 is a trimetric view of our flexible jumper in its straightened configuration; and,

FIG. 8 is the other end view of our new design showing the male end of the flexible jumper.

1 Claim, 3 Drawing Sheets

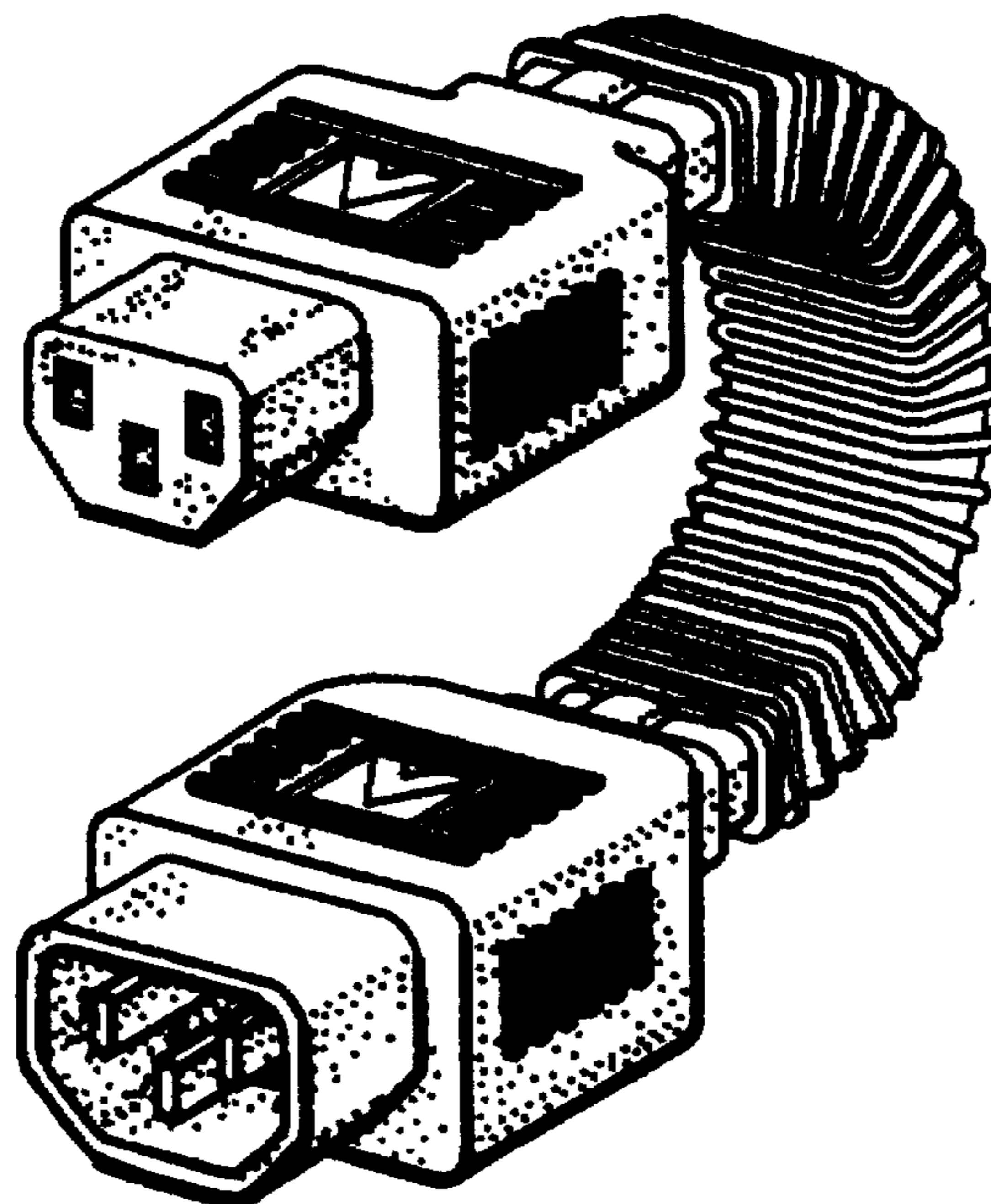

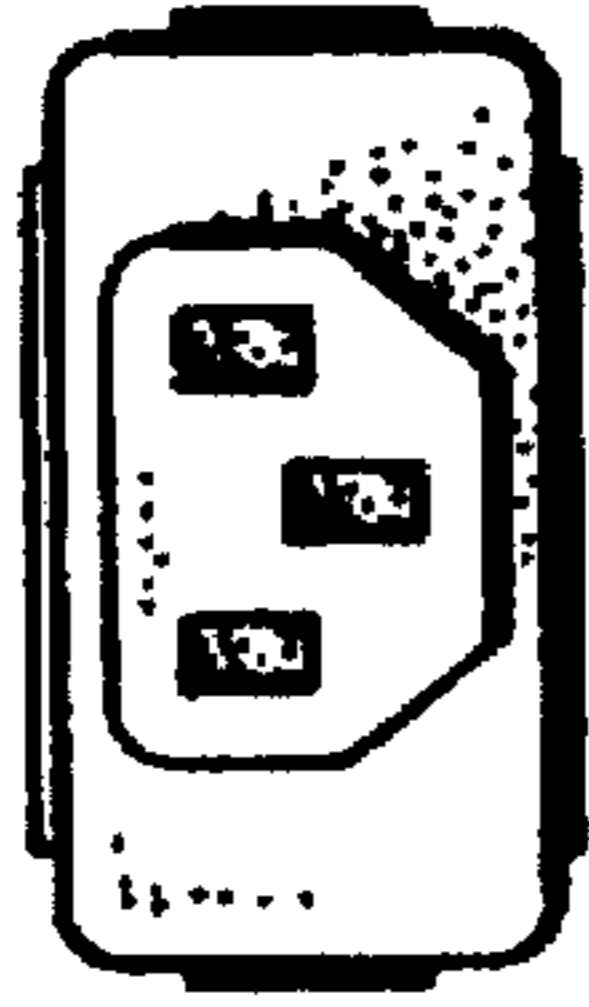

FIG. 5

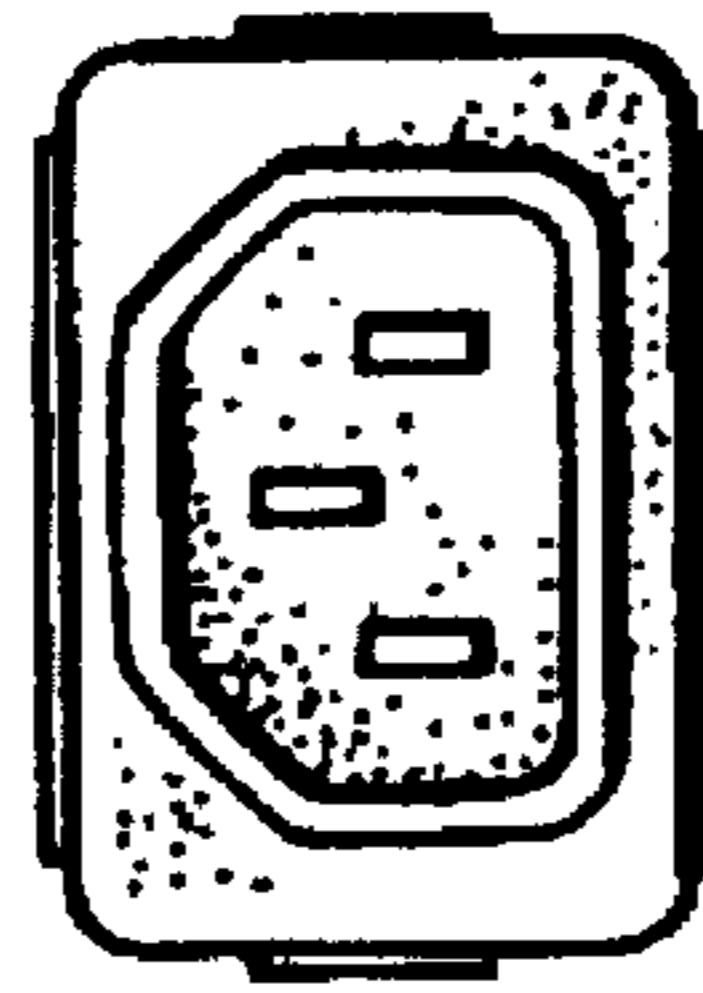

FIG. 8

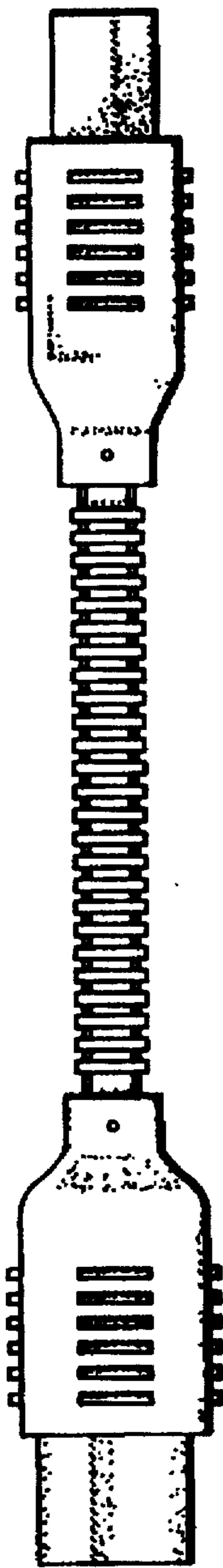

FIG. 1

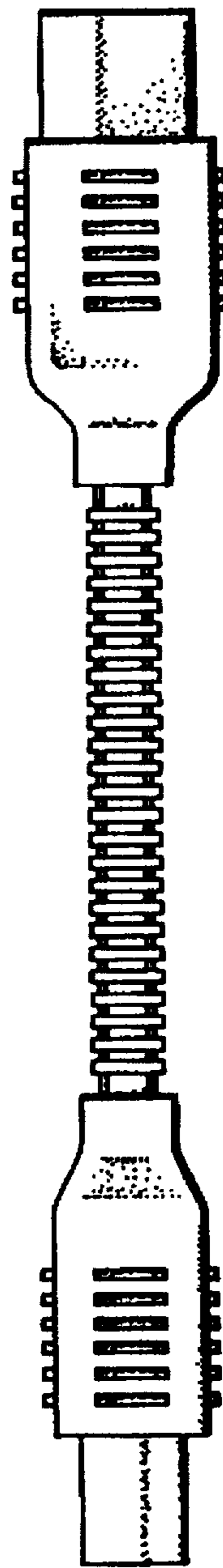

FIG. 3

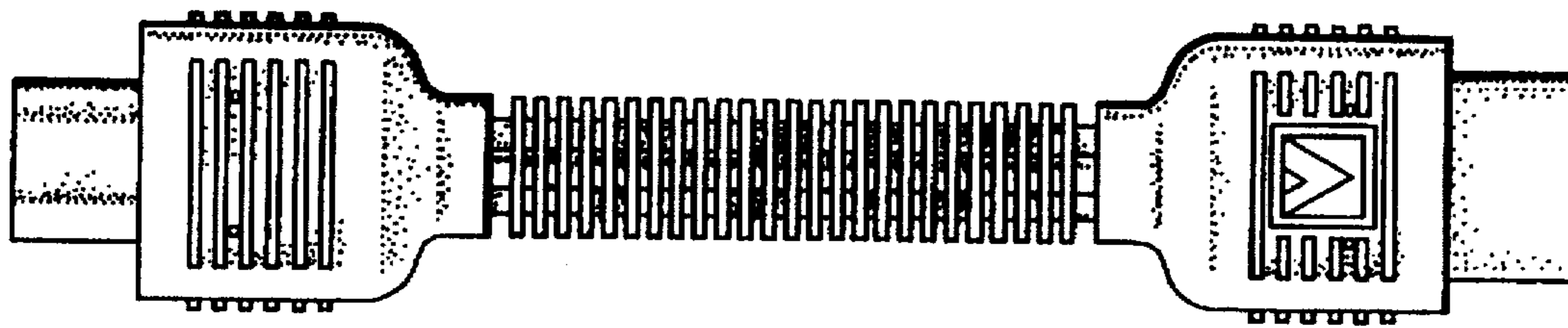

FIG. 4

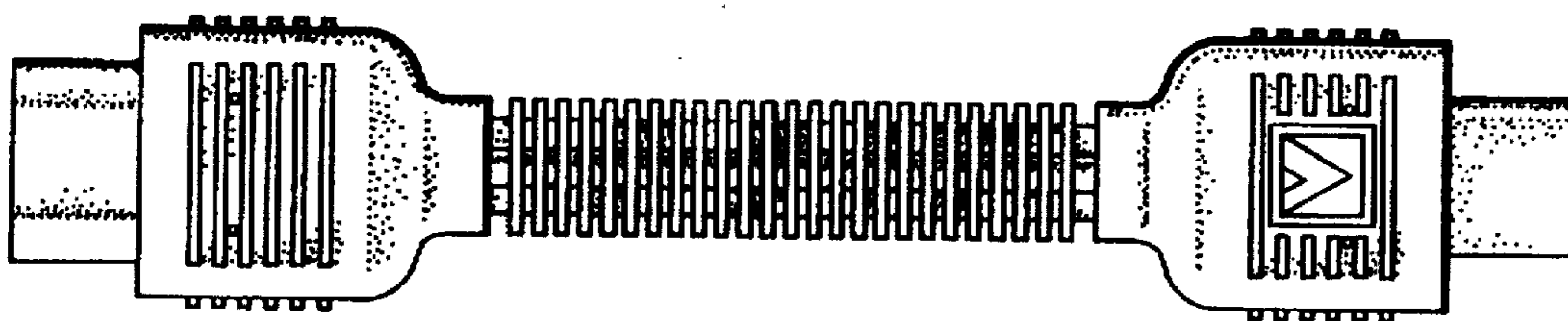

FIG. 2

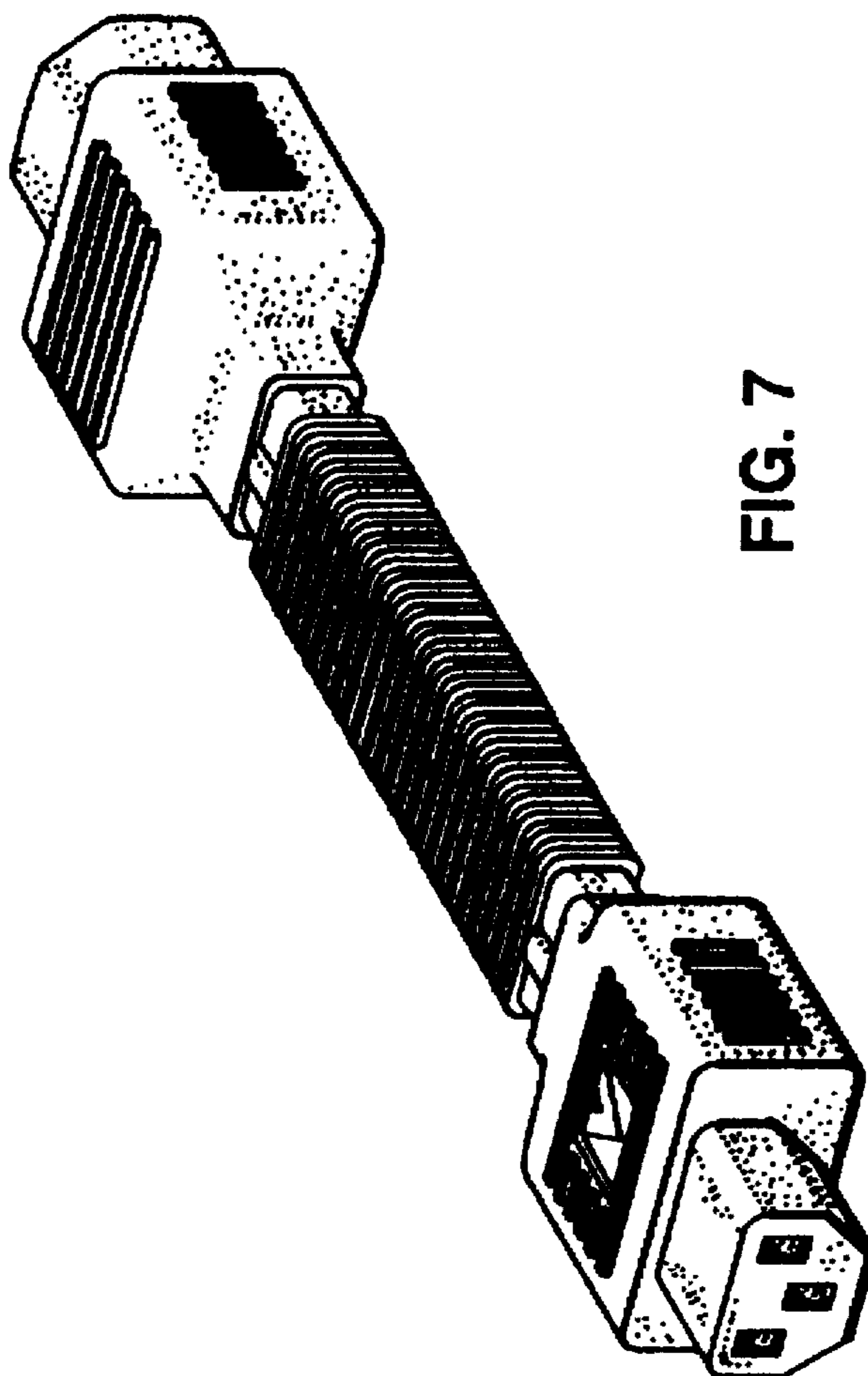

FIG. 7

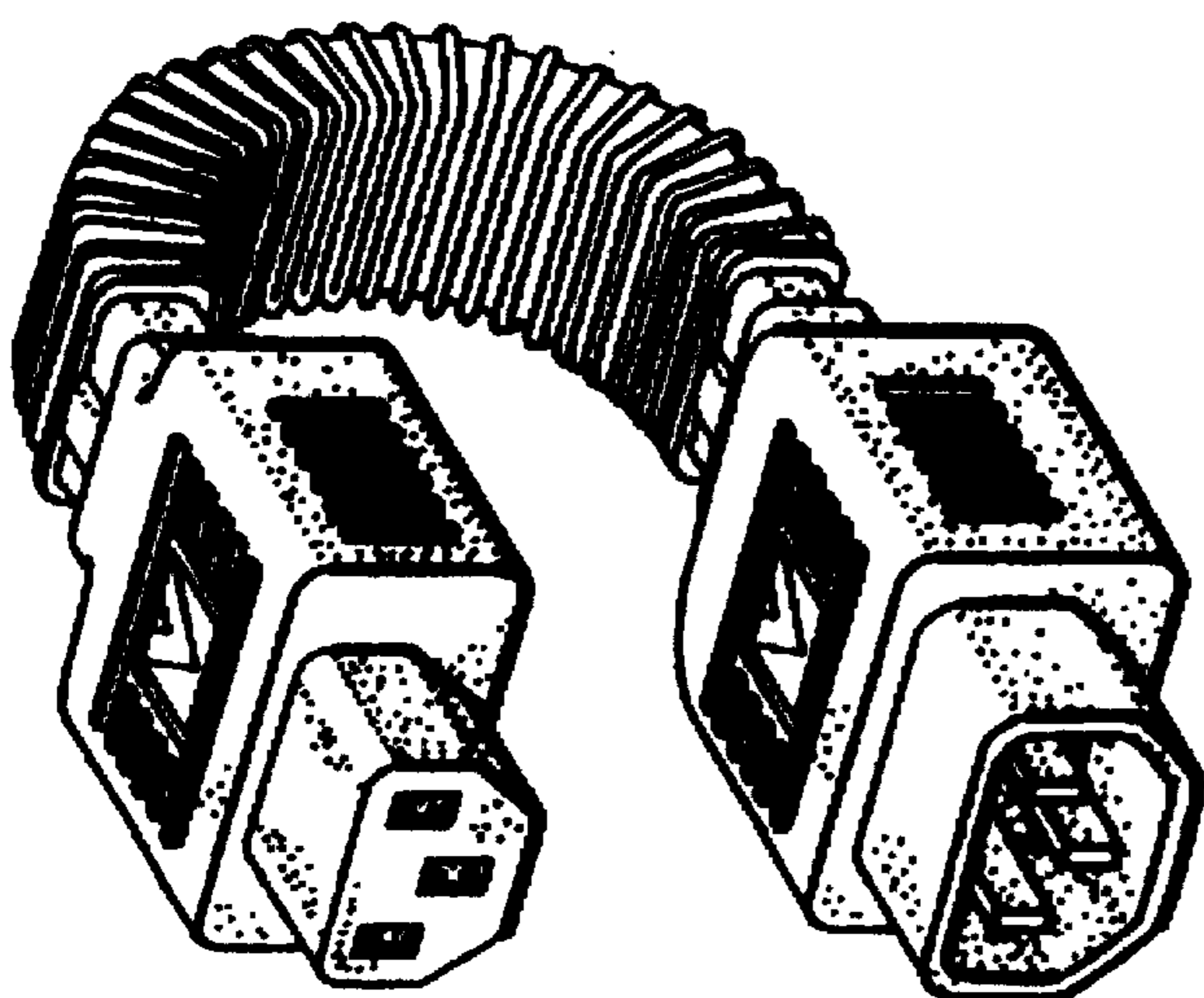

FIG. 6