



US00D384219S

United States Patent [19]

[11] Patent Number: Des. 384,219

Natuzzi et al.

[45] Date of Patent: **Sep. 30, 1997

[54] SEAT

[75] Inventors: Pasquale Natuzzi; Raffaella Lucarelli, both of Santeramo in Colle, Italy

[73] Assignee: Industrie Natuzzi, Spa, Bari, Italy

[**] Term: 14 Years

[21] Appl. No.: 59,250

[22] Filed: Sep. 5, 1996

[51] LOC (6) Cl. 06-01

[52] U.S. Cl. D6/381; D6/334; D6/335

[58] Field of Search D6/334, 335, 336, D6/364, 371, 373, 381, 500, 501, 502; 297/232, 445.1

[56] References Cited

U.S. PATENT DOCUMENTS

D. 361,909	9/1995	Natuzzi et al.	D6/381
D. 363,388	10/1995	Natuzzi et al.	D6/381
D. 365,456	12/1995	Natuzzi et al.	D6/381
D. 366,370	1/1996	Natuzzi et al.	D6/381
D. 369,475	5/1996	Natuzzi et al.	D6/335
D. 369,480	5/1996	Natuzzi et al.	D6/381

OTHER PUBLICATIONS

- Natuzzi Model 1100, Oct. 1993, International Home Furnishings Market, High Point, NC.
- Natuzzi Model 1182, Apr. 1994, at International Home Furnishings Market in High Point, North Carolina.
- Natuzzi Model 1264, Mar. 1995, at International Home Furnishings Market in High Point, North Carolina.
- Natuzzi Model 161, Oct. 1986, at International Home Furnishings Market in High Point, North Carolina.
- Natuzzi Model 166, Nov. 1986, at International Home Furnishings Market in High Point, North Carolina.
- Natuzzi Model 415, Oct. 1987, at International Home Furnishings Market in High Point, North Carolina.
- Natuzzi Model 455, Oct. 1988, at International Home Furnishings Market in High Point, North Carolina.
- Natuzzi Model 462, Oct. 1988, at International Home Furnishings Market in High Point, North Carolina.

- Natuzzi Model 459, Oct. 1988, at International Home Furnishings Market in High Point, North Carolina.
- Natuzzi Model 709, Oct. 1989, at International Home Furnishings Market in High Point, North Carolina.
- Natuzzi Model 856, Oct. 1991, at International Home Furnishings Market in High Point, North Carolina.
- Natuzzi Model 880, Oct. 1991, at International Home Furnishings Market at High Point, North Carolina.
- Natuzzi Model 932, Apr. 1992, at International Home Furnishings Market in High Point, North Carolina.
- Natuzzi Model 970, Oct. 1992, at International Home Furnishings Market in High Point, North Carolina.
- Natuzzi Model 1020, Apr. 1993, at International Home Furnishings Market in High Point, North Carolina.
- Natuzzi Model 1074, Oct. 1993, at International Home Furnishings Market in High Point, North Carolina.
- Natuzzi Model 1076, Oct. 1993, at International Home Furnishings Market in High Point, North Carolina.
- Natuzzi Model 1083, Oct. 1993, at International Home Furnishings Market in High Point, North Carolina.
- Natuzzi Model 1089, Oct. 1993, at International Home Furnishings Market in High Point, North Carolina.
- Natuzzi Model 1087, Oct. 1993, at International Home Furnishings Market in High Point, North Carolina.
- Natuzzi Model 1127, Jan. 1994, at International Home Furnishings Market in High Point, North Carolina.

Primary Examiner—Gary D. Watson
Attorney, Agent, or Firm—Bell, Seltzer, Park & Gibson, P.A.

[57] CLAIM

The ornamental design for a seat, as shown and described.

DESCRIPTION

- FIG. 1 is a front perspective view of a seat showing our new design in the form of a sofa;
- FIG. 2 is a front elevational view thereof;
- FIG. 3 is a top plan view thereof;
- FIG. 4 is a right side elevational view, the left side being a mirror image thereof;
- FIG. 5 is a rear perspective view thereof;
- FIG. 6 is a front elevational view of a seat showing our new design in the form of a loveseat;
- FIG. 7 is a front elevational view of a seat showing our new design in the form of a chair;

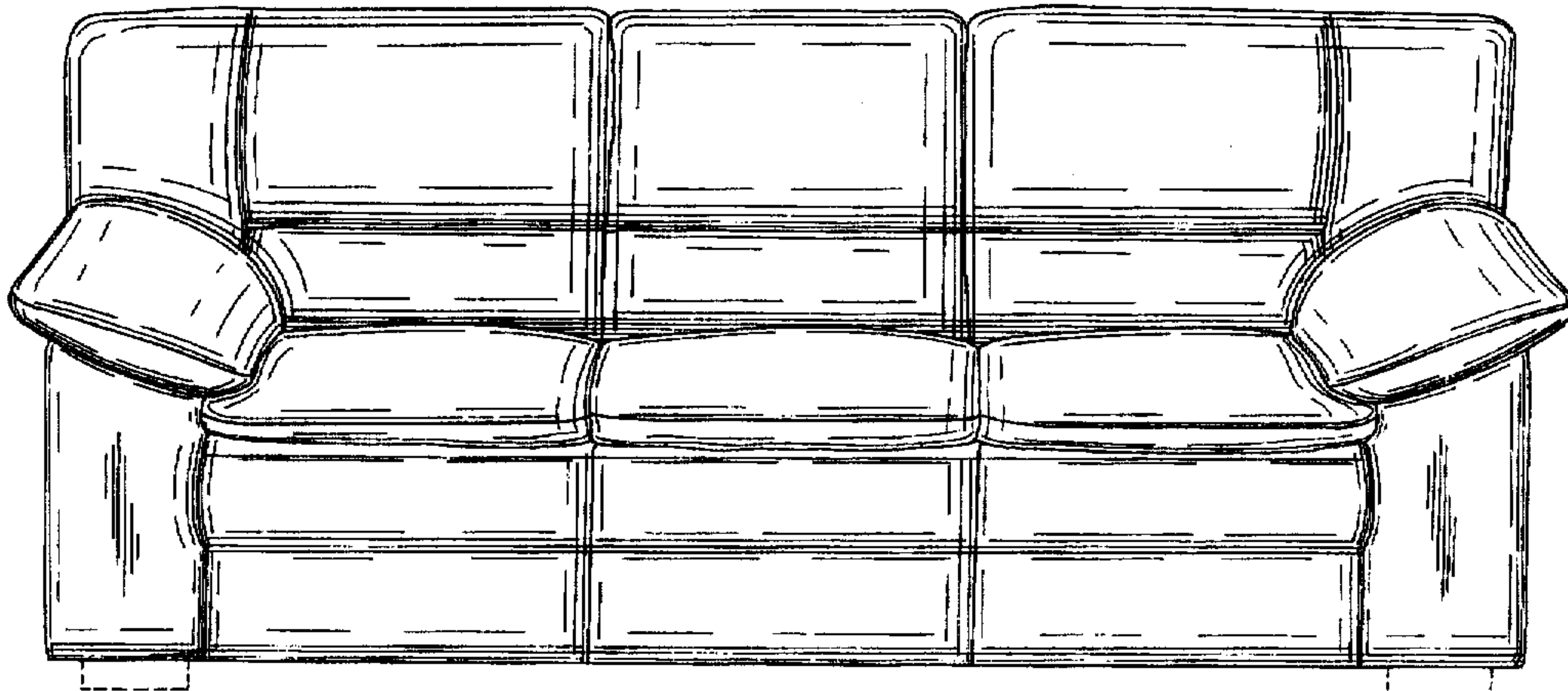

FIG. 8 is a front perspective view of a seat showing our new design in the form of a sectional sofa; and, FIG. 9 is a top plan view thereof.

The broken lines shown herein are for illustrative purposes only and form no part of the claimed design.

The rear views of FIGS. 6, 7, and 8 are like FIG. 5, the difference being a matter of length.

FIGS. 2 through 9 have been shown on a reduced scale with respect to FIG. 1 but FIG. 5 is on a larger scale than FIGS. 2, 3, 4, 6, 7, 8 and 9.

1 Claim, 5 Drawing Sheets

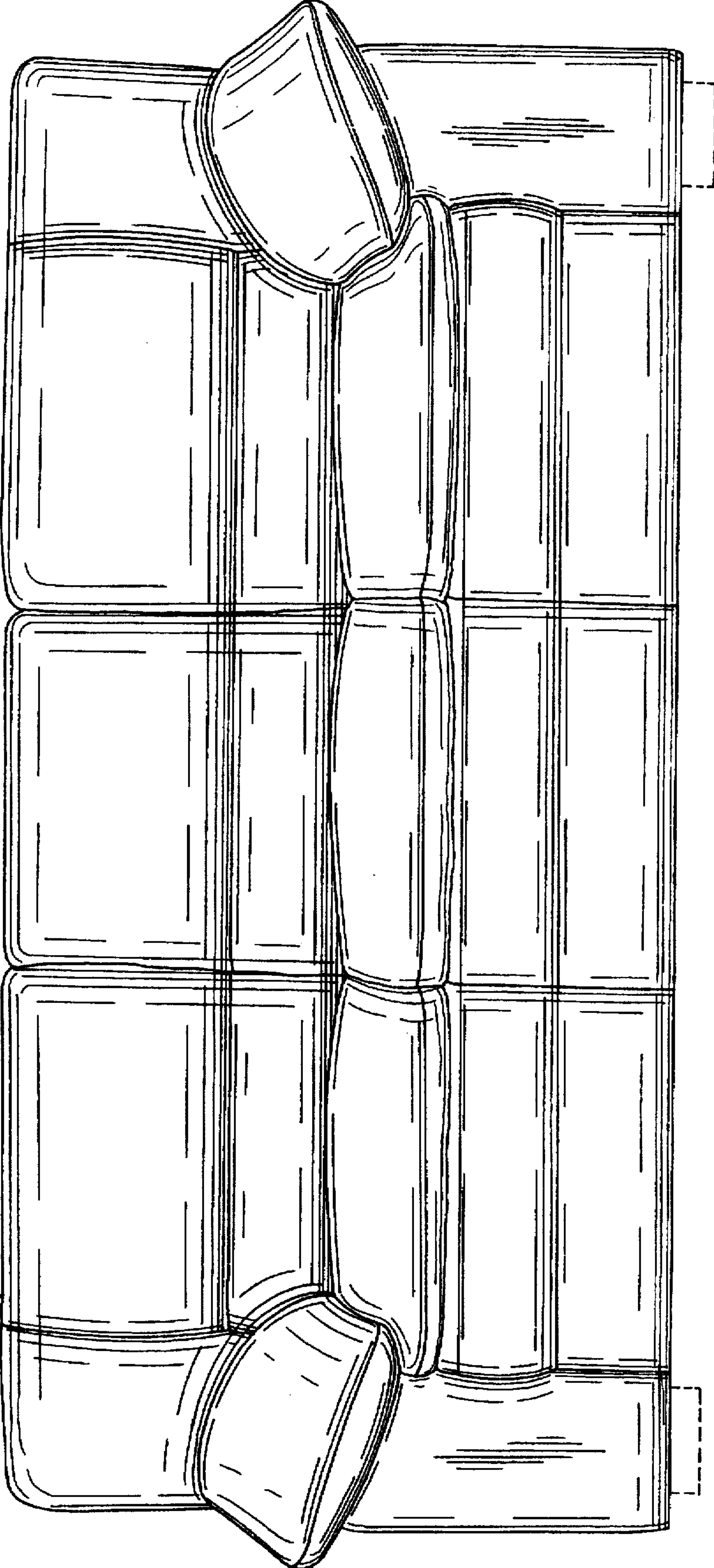

FIG. 1.

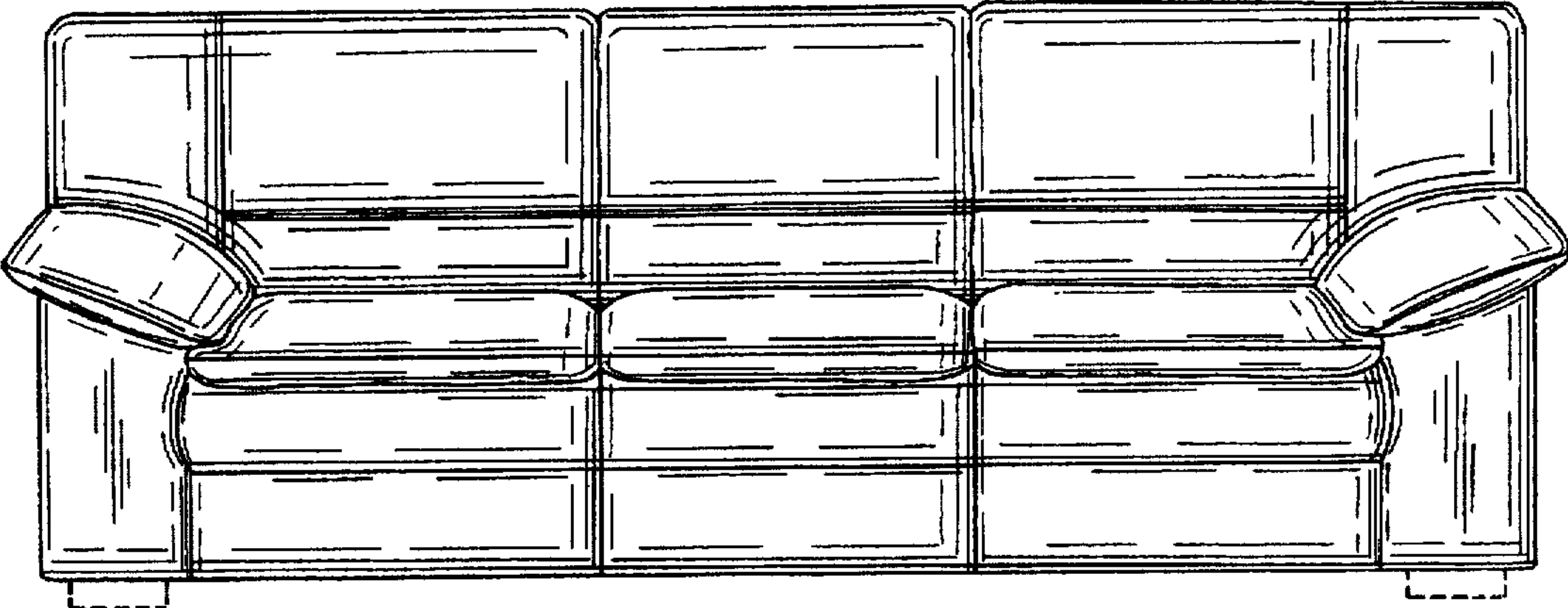

FIG. 2.

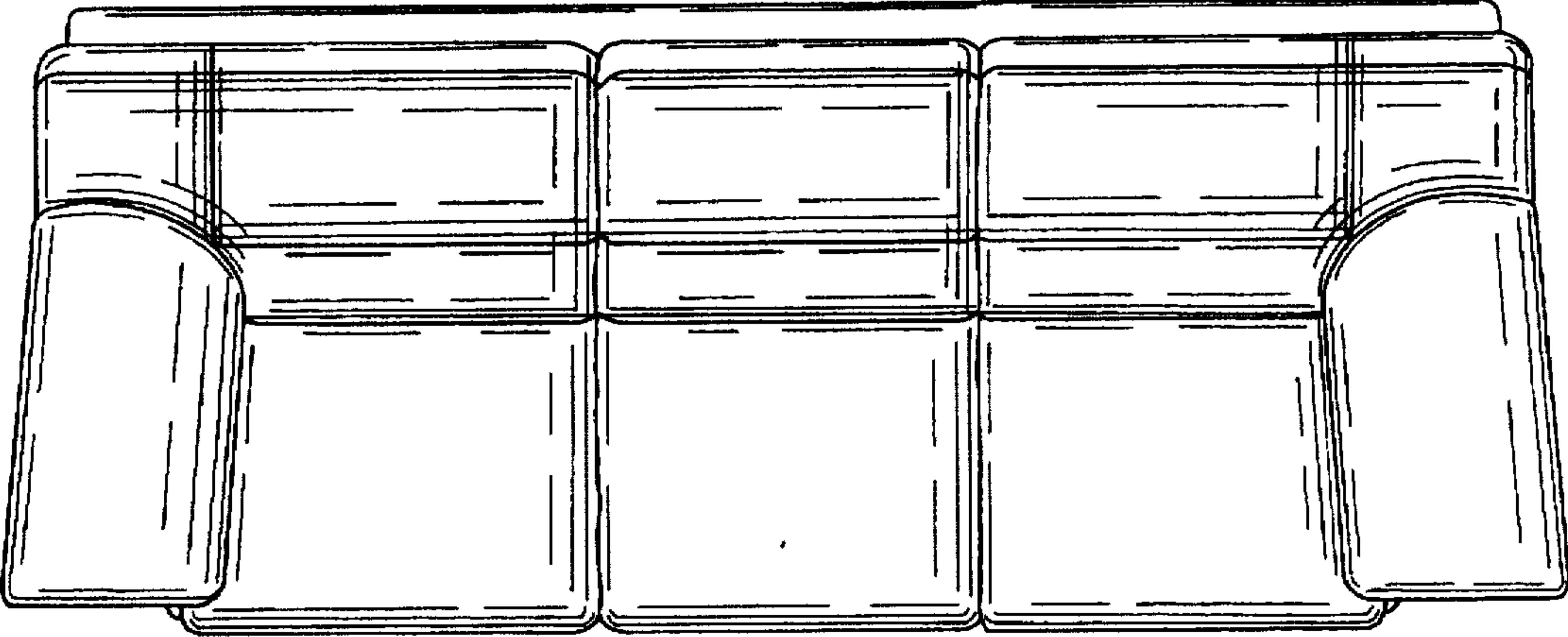

FIG. 3.

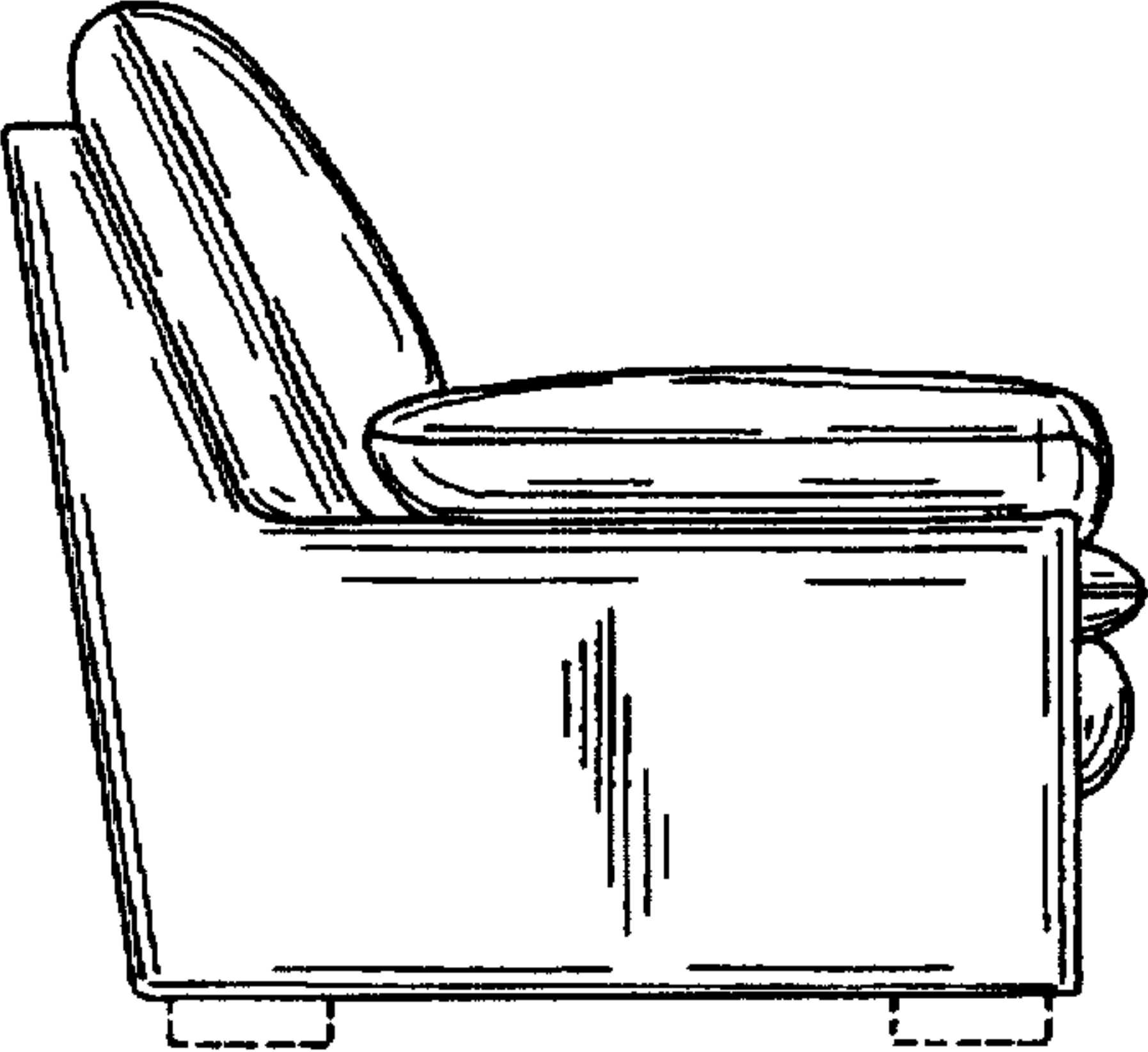

FIG. 4.

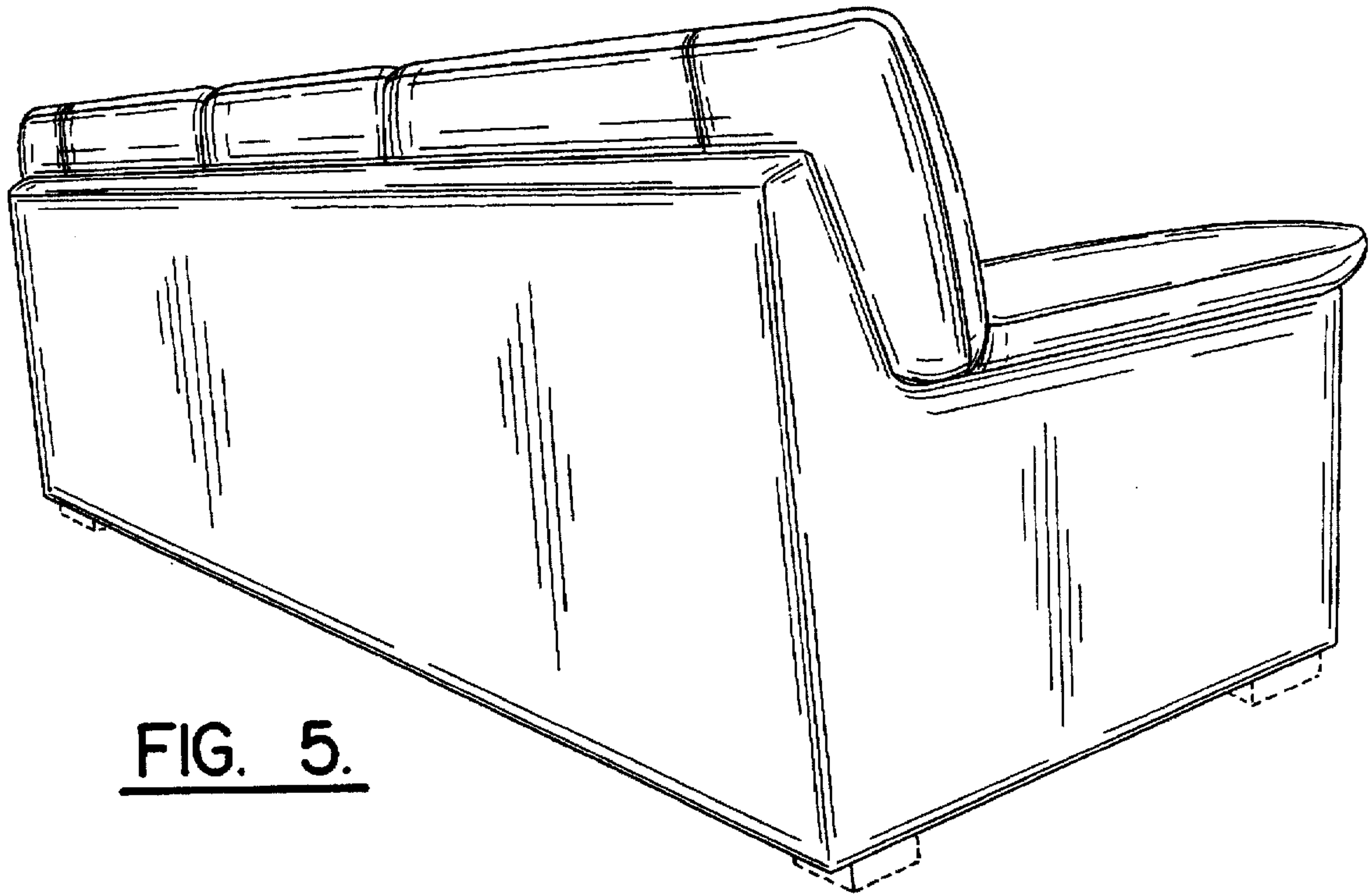

FIG. 5.

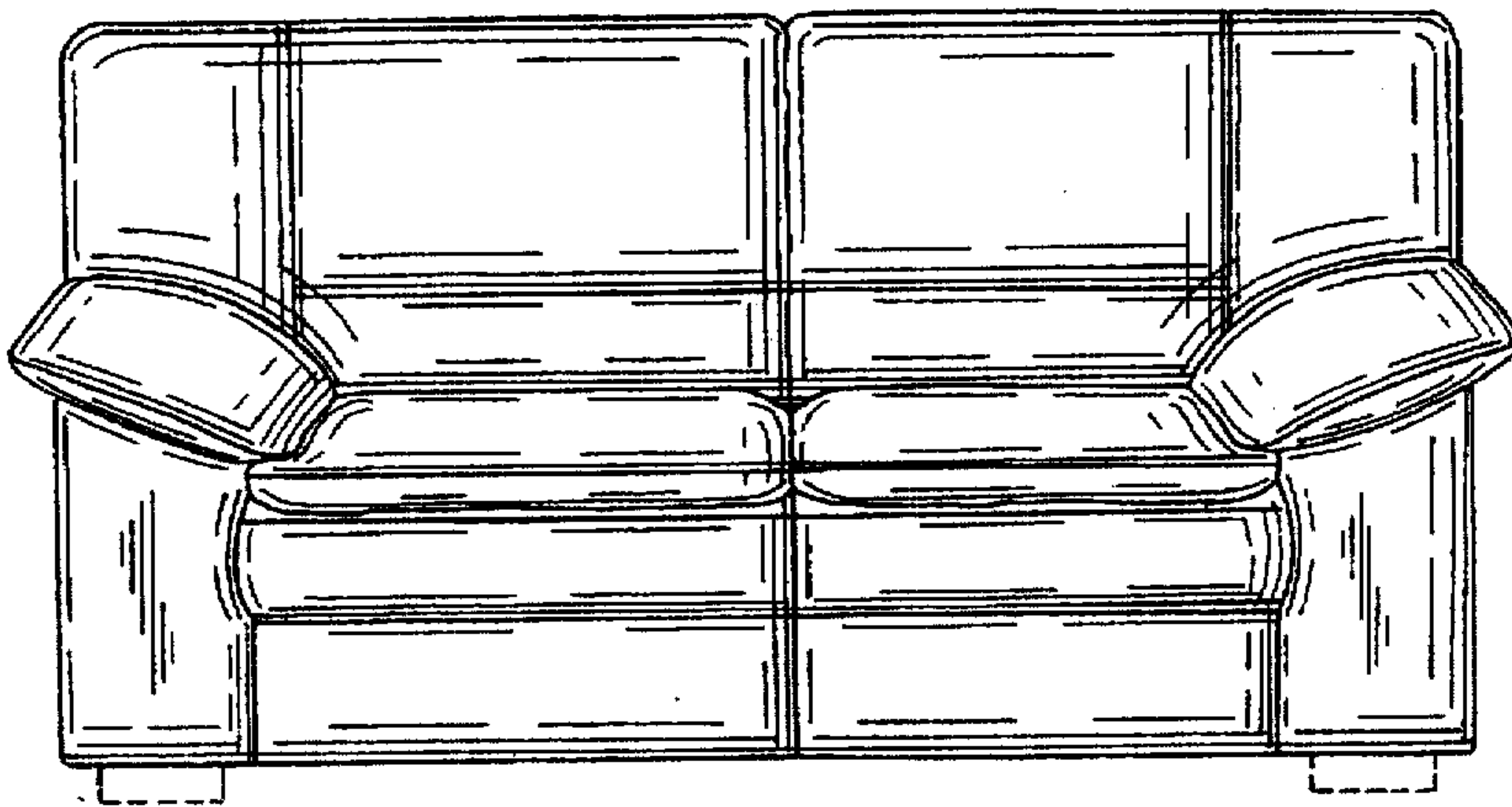
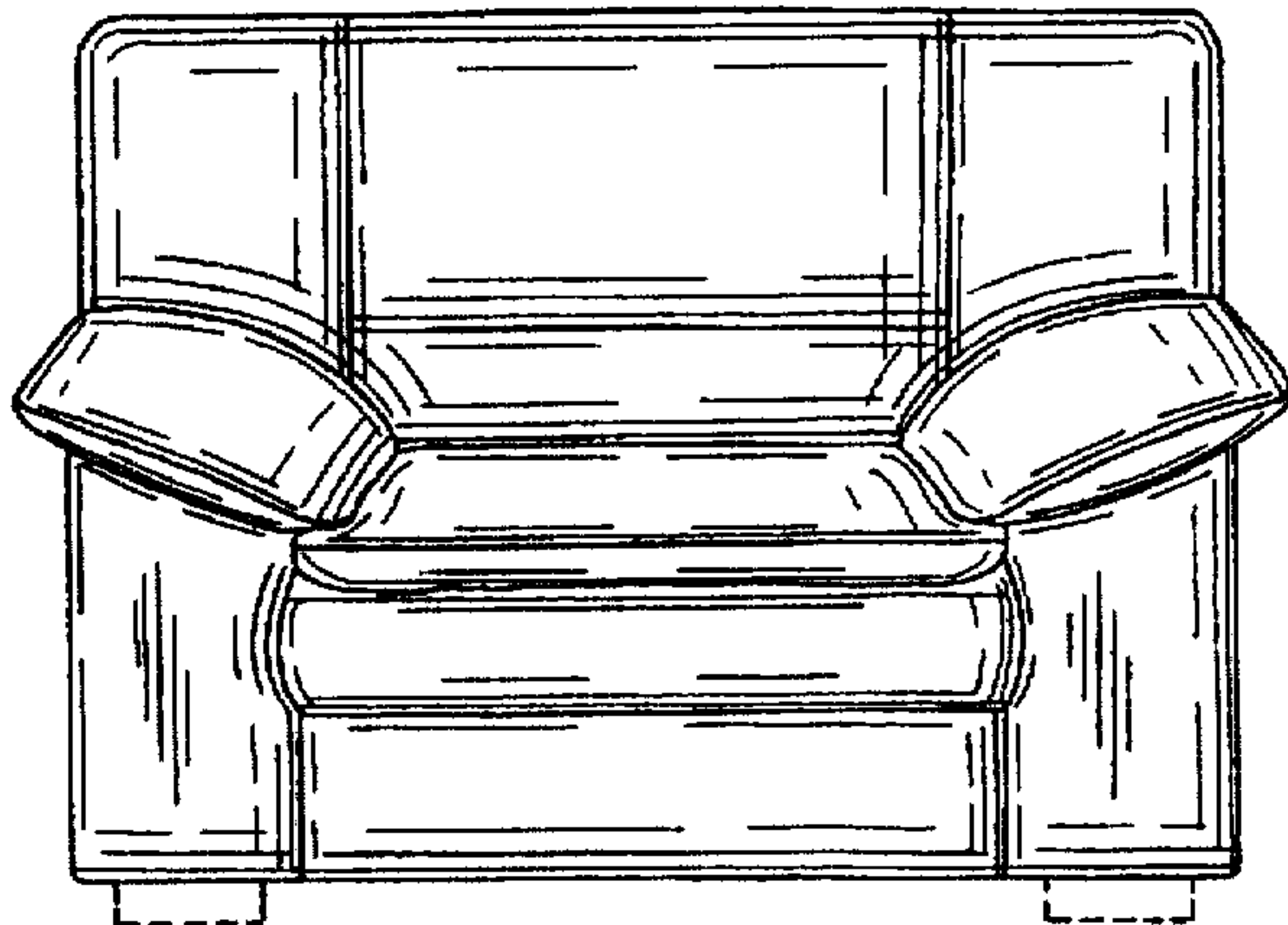

FIG. 6.

FIG. 7.



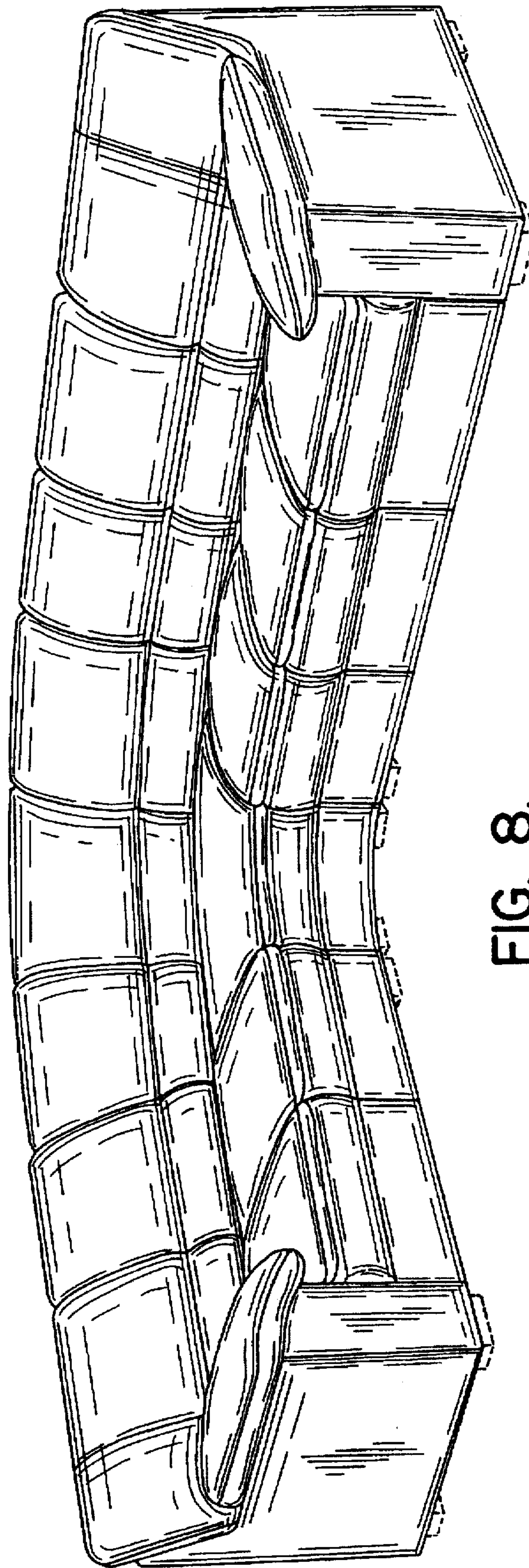

FIG. 8.

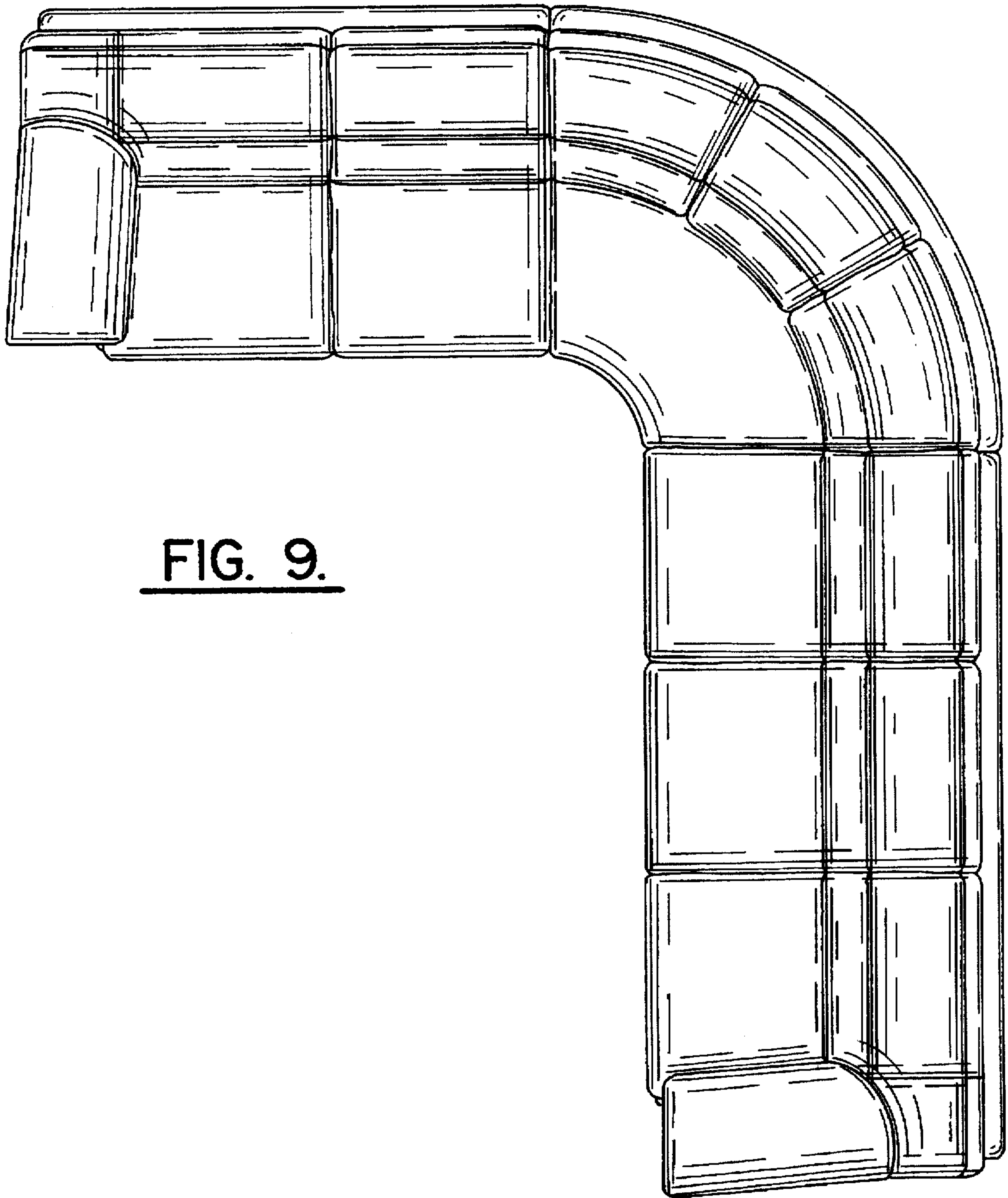

FIG. 9.