



US00D384218S

# United States Patent [19]

Natuzzi et al.

[11] Patent Number: Des. 384,218

[45] Date of Patent: \*\*Sep. 30, 1997

[54] SEAT

[75] Inventors: Pasquale Natuzzi, Santeramo In Colle; Arcangelo Scarati, Talsano, both of Italy

[73] Assignee: Industrie Natuzzi, SpA, Bari, Italy

[\*\*] Term: 14 Years

[21] Appl. No.: 59,249

[22] Filed: Sep. 5, 1996

[51] LOC (6) Cl. .... 06-01

[52] U.S. Cl. .... D6/381; D6/334

[58] Field of Search ..... D6/334, 335, 364, D6/371, 373, 381, 500, 501, 502; 297/232, 445.1

### [56] References Cited

#### U.S. PATENT DOCUMENTS

D. 360,774	8/1995	Natuzzi et al. ....	D6/381
D. 361,909	9/1995	Natuzzi et al. ....	D6/381
D. 364,975	12/1995	Natuzzi et al. ....	D6/381
D. 367,371	2/1996	Natuzzi et al. ....	D6/381
D. 370,363	6/1996	Natuzzi et al. ....	D6/381

#### OTHER PUBLICATIONS

Natuzzi Model 462, Oct. 1988, at International Home Furnishings Market in High Point, North Carolina.  
 Natuzzi Model 485, Apr. 1989, at International Home Furnishings Market in High Point, North Carolina.  
 Natuzzi Model 803, Oct. 1990, at International Home Furnishings Market in High Point, North Carolina.  
 Natuzzi Model 827, Apr. 1991, at International Home Furnishings Market in High Point, North Carolina.  
 Natuzzi Model 881, Oct. 1991, at International Home Furnishings Market in High Point, North Carolina.  
 Natuzzi Model 882, Oct. 1991, at International Home Furnishings Market in High Point, North Carolina.  
 Natuzzi Model 892, Oct. 1991, at International Home Furnishings Market in High Point, North Carolina.

Natuzzi Model 954, Oct. 1992, at International Home Furnishings Market in High Point, North Carolina.  
 Natuzzi Model 1040, Apr. 1993, at International Home Furnishings Market in High Point, North Carolina.  
 Natuzzi Model 1074, Oct. 1993, at International Home Furnishings Market in High Point, North Carolina.  
 Natuzzi Model 1098, Oct. 1993, at International Home Furnishings Market in High Point, North Carolina.  
 Natuzzi Model 1154, Apr. 1994 at International Home Furnishings Market in High Point, North Carolina.  
 Natuzzi Model 1156, Apr. 1994, at International Home Furnishings Market in High Point, North Carolina.  
 Natuzzi Model 1168, Apr. 1994, at International Home Furnishings Market in High Point, North Carolina.

Primary Examiner—Gary D. Watson  
 Attorney, Agent, or Firm—Bell, Seltzer, Park & Gibson, P.A.

### [57] CLAIM

The ornamental design for a seat, as shown and described.

### DESCRIPTION

FIG. 1 is a front perspective view of a seat showing our new design in the form of a sofa;  
 FIG. 2 is a front elevational view thereof;  
 FIG. 3 is a top plan view thereof;  
 FIG. 4 is a right side elevational view, the left side being a mirror image thereof;  
 FIG. 5 is a rear perspective view thereof;  
 FIG. 6 is a front elevational view of a seat showing our new design in the form of a loveseat; and,  
 FIG. 7 is a front elevational view of a seat showing our new design in the form of a chair.  
 The broken lines shown herein are for illustrative purposes only and form no part of the claimed design.  
 The rear views of FIGS. 6 and 7 are like FIG. 5, the difference being a matter of length.  
 FIGS. 2 through 7 have been shown on a reduced scale with respect to FIG. 1 but FIG. 5 is on a larger scale than FIGS. 2, 3, 4, 6 and 7.

1 Claim, 3 Drawing Sheets

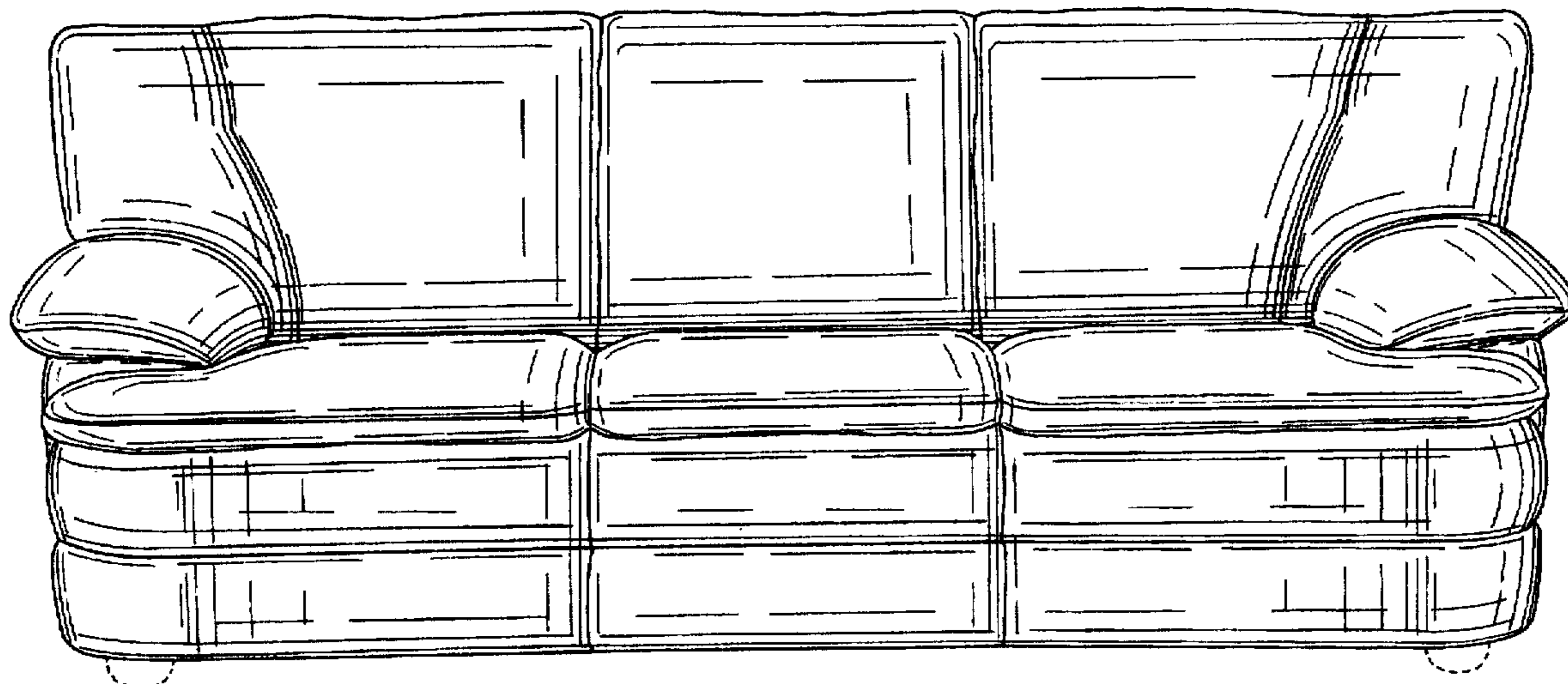

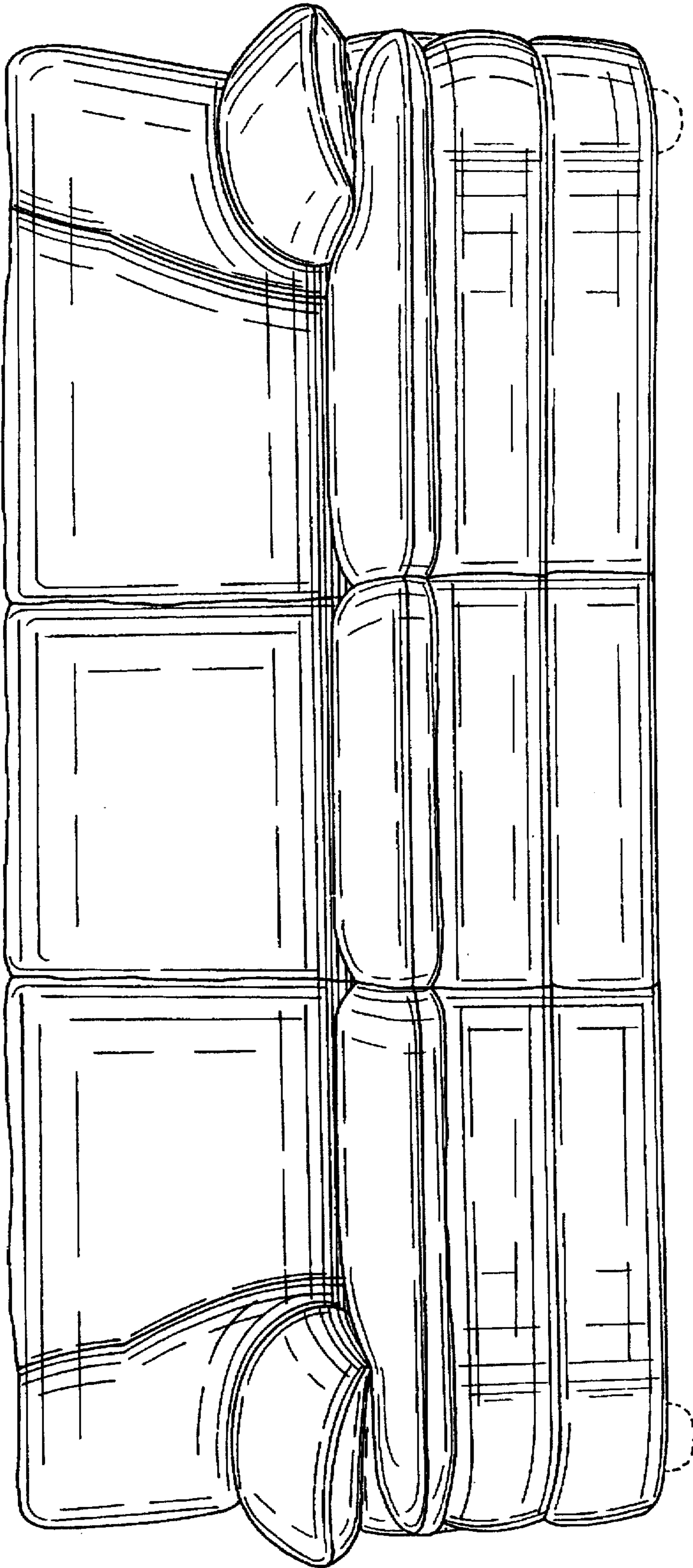

FIG. 1.



FIG. 2.



FIG. 3.

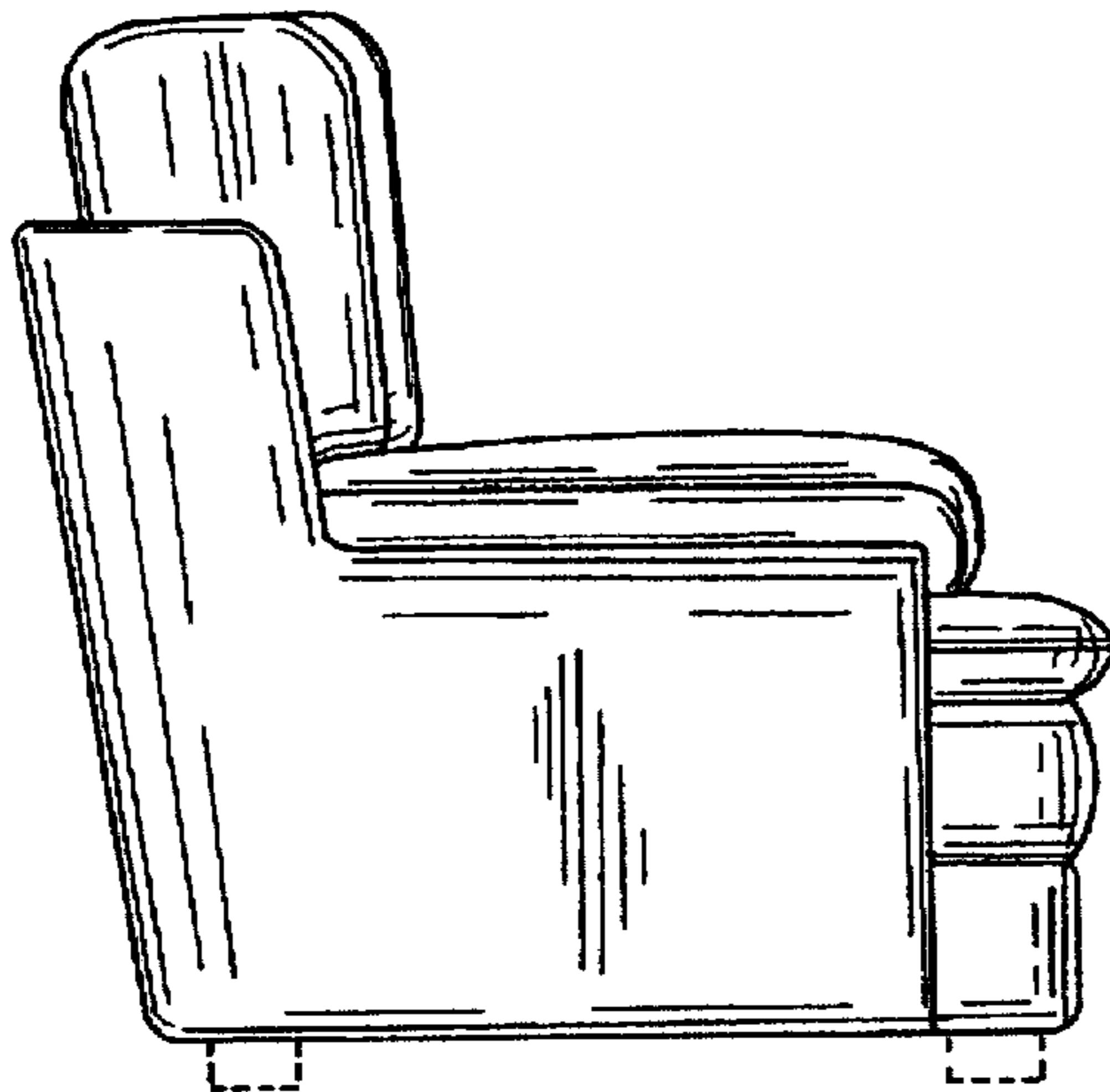

FIG. 4.

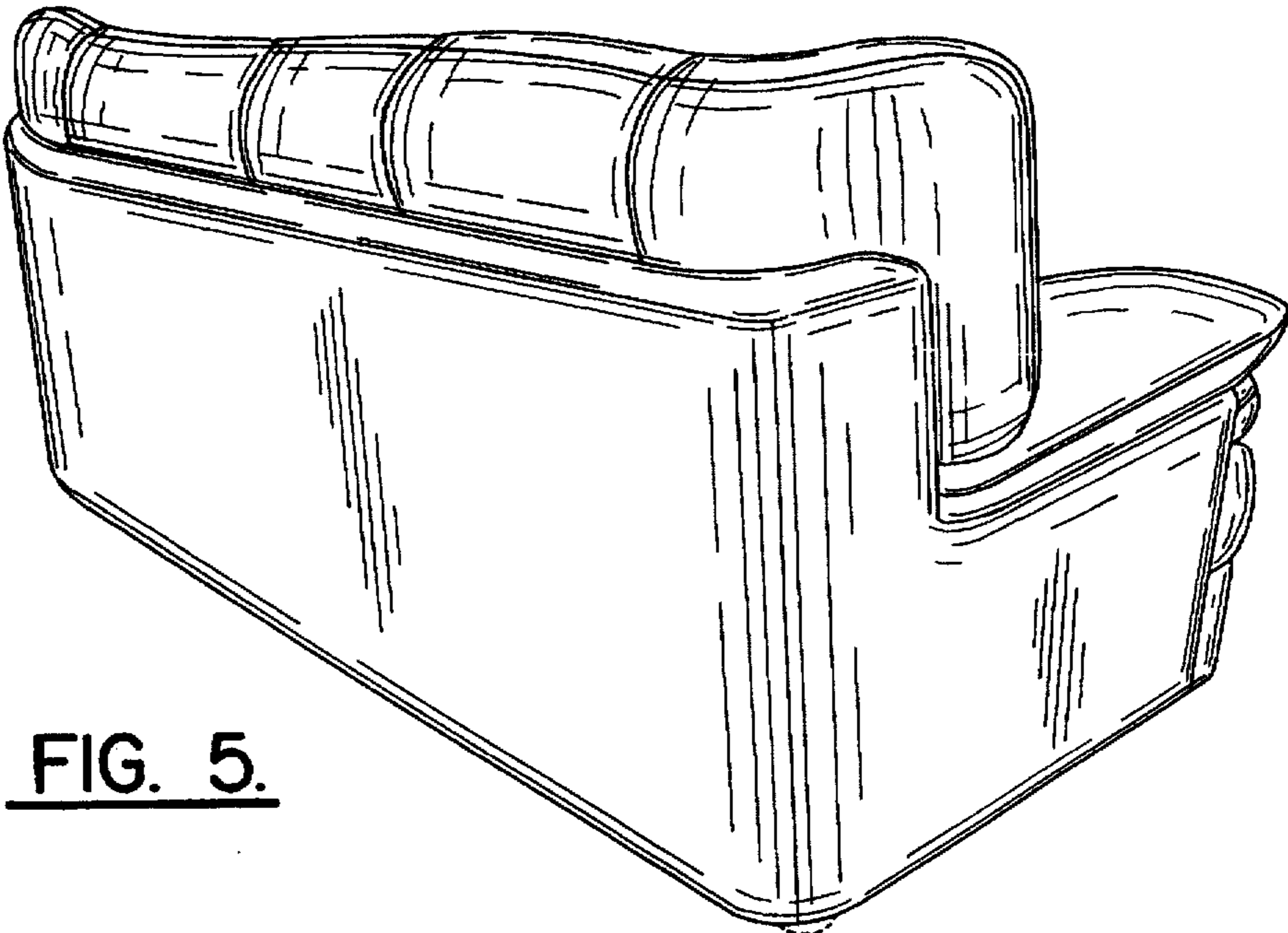

FIG. 5.

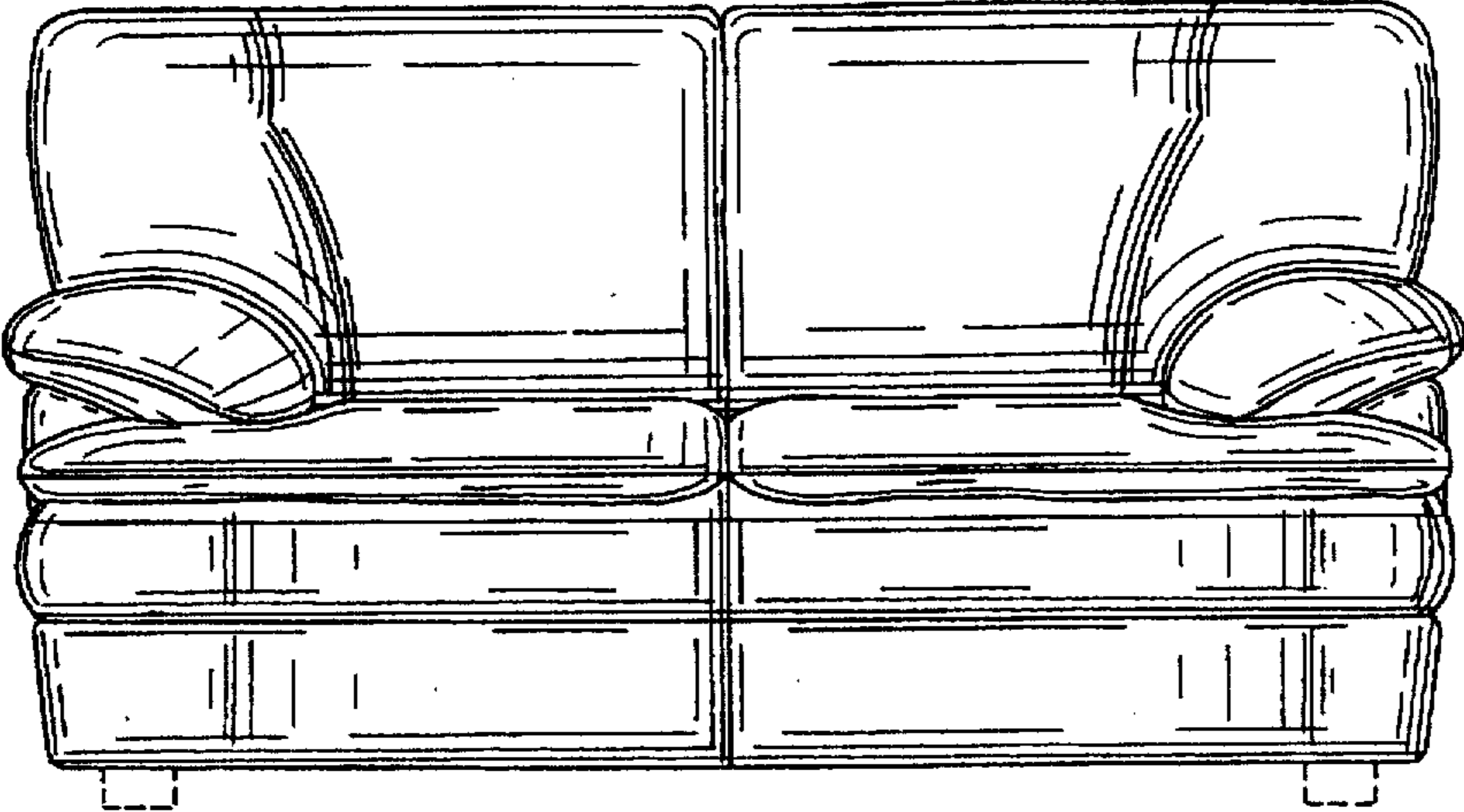

FIG. 6.

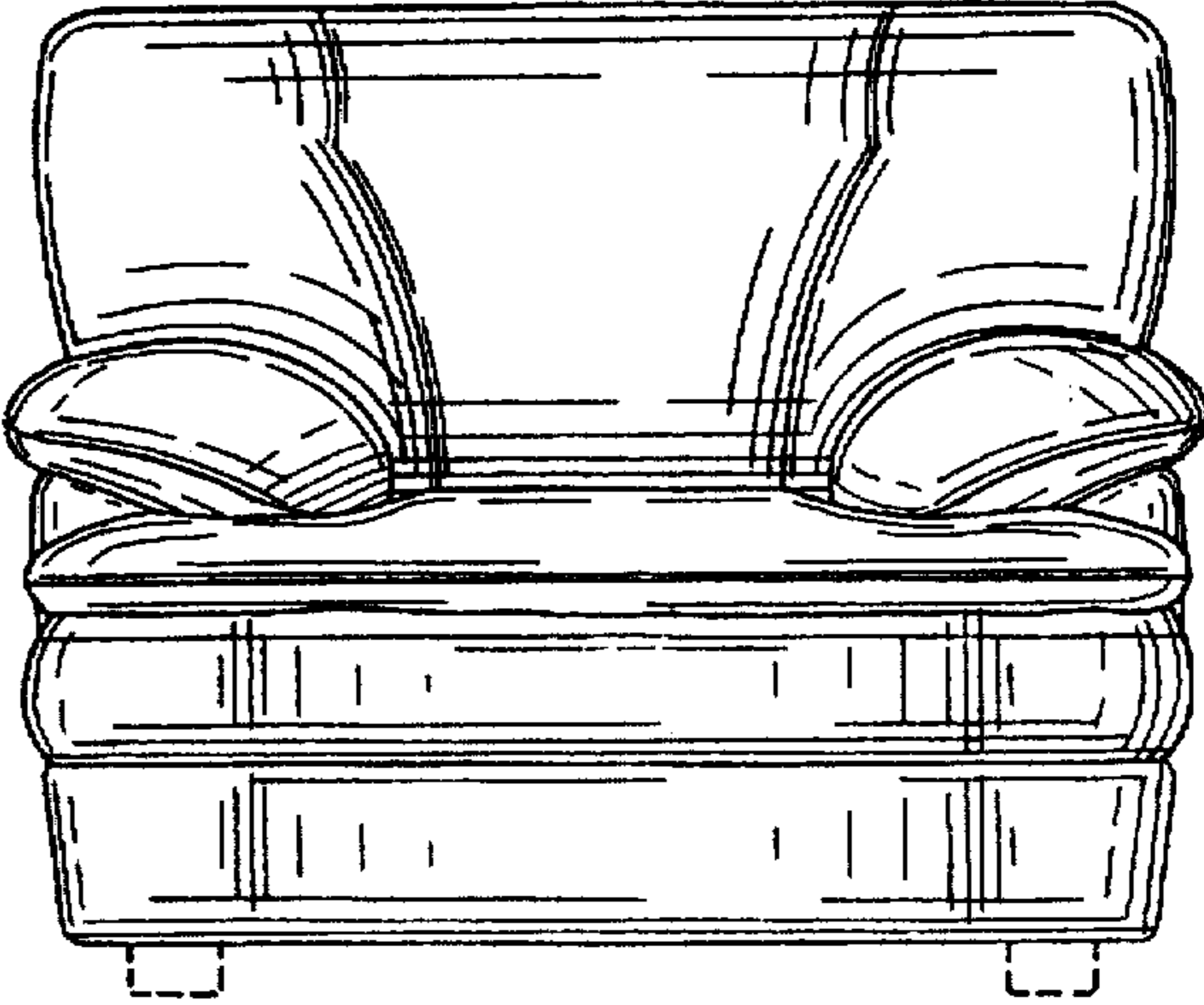

FIG. 7.