



US00D384217S

United States Patent [19]

[11] Patent Number: **Des. 384,217**

Natuzzi et al.

[45] Date of Patent: ****Sep. 30, 1997**

[54] SEAT

[75] Inventors: **Pasquale Natuzzi**, Santeramo In Colle;
Domenico Abbruzzese, Gioia del Colle,
both of Italy

[73] Assignee: **Industrie Natuzzi, Spa**, Bari, Italy

[**] Term: **14 Years**

[21] Appl. No.: **59,246**

[22] Filed: **Sep. 5, 1996**

[51] LOC (6) Cl. **06-01**

[52] U.S. Cl. **D6/381; D6/334**

[58] Field of Search **D6/334, 335, 364,**
D6/371, 373, 381, 500, 501, 502; 297/232,
445.1

[56] References Cited

U.S. PATENT DOCUMENTS

| | | | |
|------------|---------|---------------------|--------|
| D. 351,954 | 11/1994 | Gera | D6/381 |
| D. 360,542 | 7/1995 | Natuzzi et al. | D6/381 |
| D. 360,774 | 8/1995 | Natuzzi et al. | D6/381 |
| D. 362,562 | 9/1995 | Natuzzi et al. | D6/381 |
| D. 365,457 | 12/1995 | Natuzzi et al. | D6/381 |
| D. 374,355 | 10/1996 | Natuzzi et al. | D6/381 |

OTHER PUBLICATIONS

- Natuzzi Model 444, Apr. 1988, at International Home Furnishings Market in High Point, North Carolina.
- Natuzzi Model 492, Apr. 1989, at International Home Furnishings Market in High Point, North Carolina.
- Natuzzi Model 734, Apr. 1990, at International Home Furnishings Market in High Point, North Carolina.
- Natuzzi Model 738, Apr. 1990, at International Home Furnishings Market in High Point, North Carolina.
- Natuzzi Model 750, Oct. 1990, at International Home Furnishings Market in High Point, North Carolina.
- Natuzzi Model 751, Apr. 1990, at International Home Furnishings Market in High Point, North Carolina.
- Natuzzi Model 758, Apr. 1990, at International Home Furnishings Market in High Point, North Carolina.
- Natuzzi Model 785, Oct. 1990, at International Home Furnishings Market in High Point, North Carolina.

- Natuzzi Model 798, Oct. 1990, at International Home Furnishings Market in High Point, North Carolina.
- Natuzzi Model 900, Apr. 1992, at International Home Furnishings Market in High Point, North Carolina.
- Natuzzi Model 911, Apr. 1992, at International Home Furnishings Market in High Point, North Carolina.
- Natuzzi Model 915, Apr. 1992, at International Home Furnishings Market in High Point, North Carolina.
- Natuzzi Model 925, Apr. 1992, at International Home Furnishings Market in High Point, North Carolina.
- Natuzzi Model 1066, Oct. 1993, at International Home Furnishings Market in High Point, North Carolina.
- Natuzzi Model 1068, Oct. 1993, at International Home Furnishings Market in High Point, North Carolina.

(List continued on next page.)

Primary Examiner—Gary D. Watson
Attorney, Agent, or Firm—Bell, Seltzer, Park & Gibson, P.A.

[57] CLAIM

The ornamental design for a seat, as shown and described.

DESCRIPTION

FIG. 1 is a front perspective view of a seat showing our new design in the form of a sofa;
 FIG. 2 is a front elevational view thereof;
 FIG. 3 is a top plan view thereof;
 FIG. 4 is a right side elevational view, the left side being a mirror image thereof;
 FIG. 5 is a rear perspective view thereof;
 FIG. 6 is a front elevational view of a seat showing our new design in the form of a loveseat; and,
 FIG. 7 is a front elevational view of a seat showing our new design in the form of a chair.

The broken lines shown herein are for illustrative purposes only and form no part of the claimed design.

The rear views of FIGS. 6 and 7 are like FIG. 5, the difference being a matter of length.

FIGS. 2 through 7 have been shown on a reduced scale with respect to FIG. 1.

1 Claim, 3 Drawing Sheets

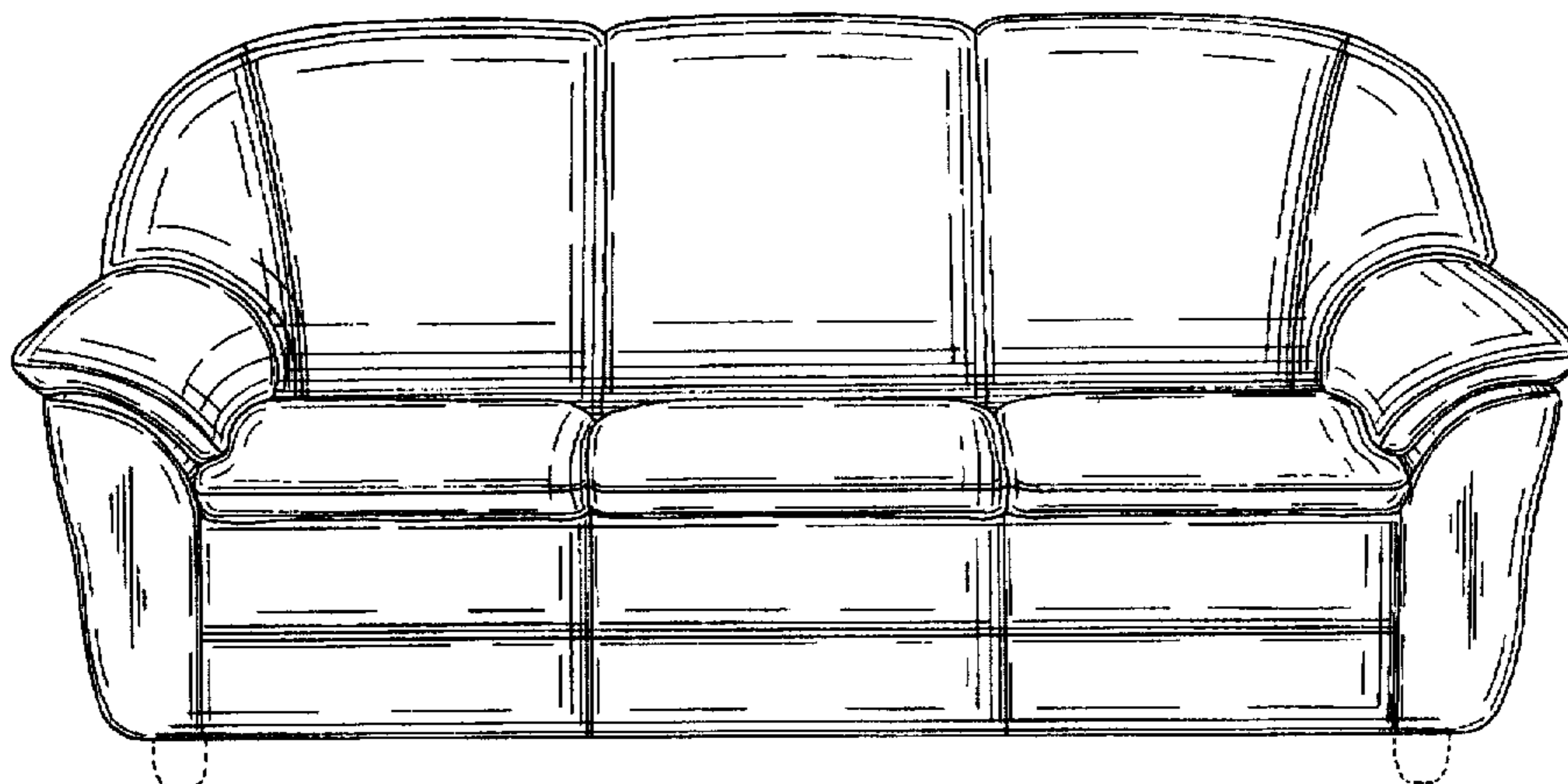

OTHER PUBLICATIONS

Natuzzi Model 1087, at International Home Furnishings Market in High Point, North Carolina.

Natuzzi Model 1100, Oct. 1993, at International Home Furnishings Market in High Point, North Carolina.

Natuzzi Model 1297, Mar. 1995, at International Home Furnishings Market in High Point, North Carolina.

Natuzzi Model 1342, Oct. 1994, at International Home Furnishings Market in High Point, North Carolina.

Natuzzi Model 1351, Sep. 1995, at International Home Furnishings Market in High Point, North Carolina.

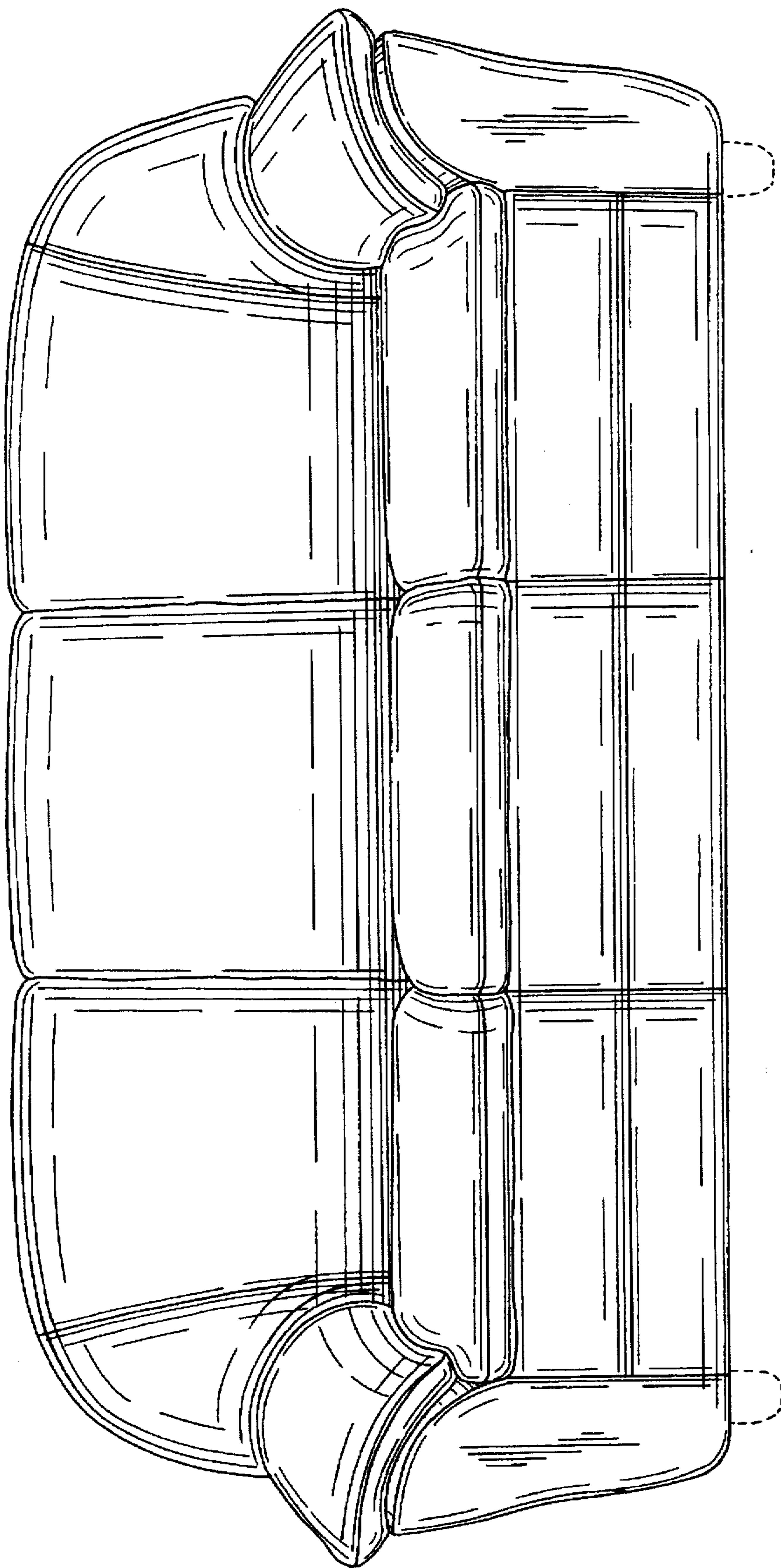

FIG. 1.

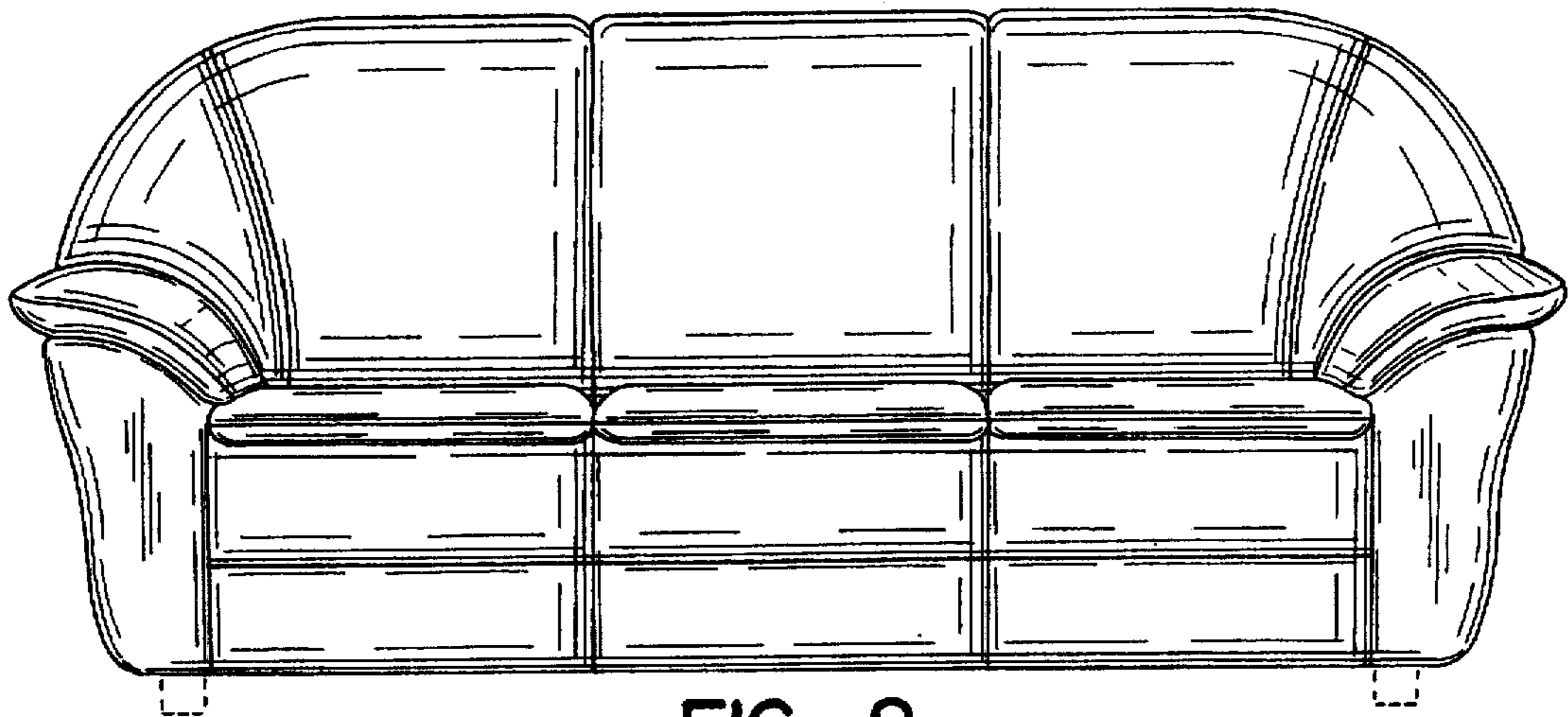

FIG. 2.

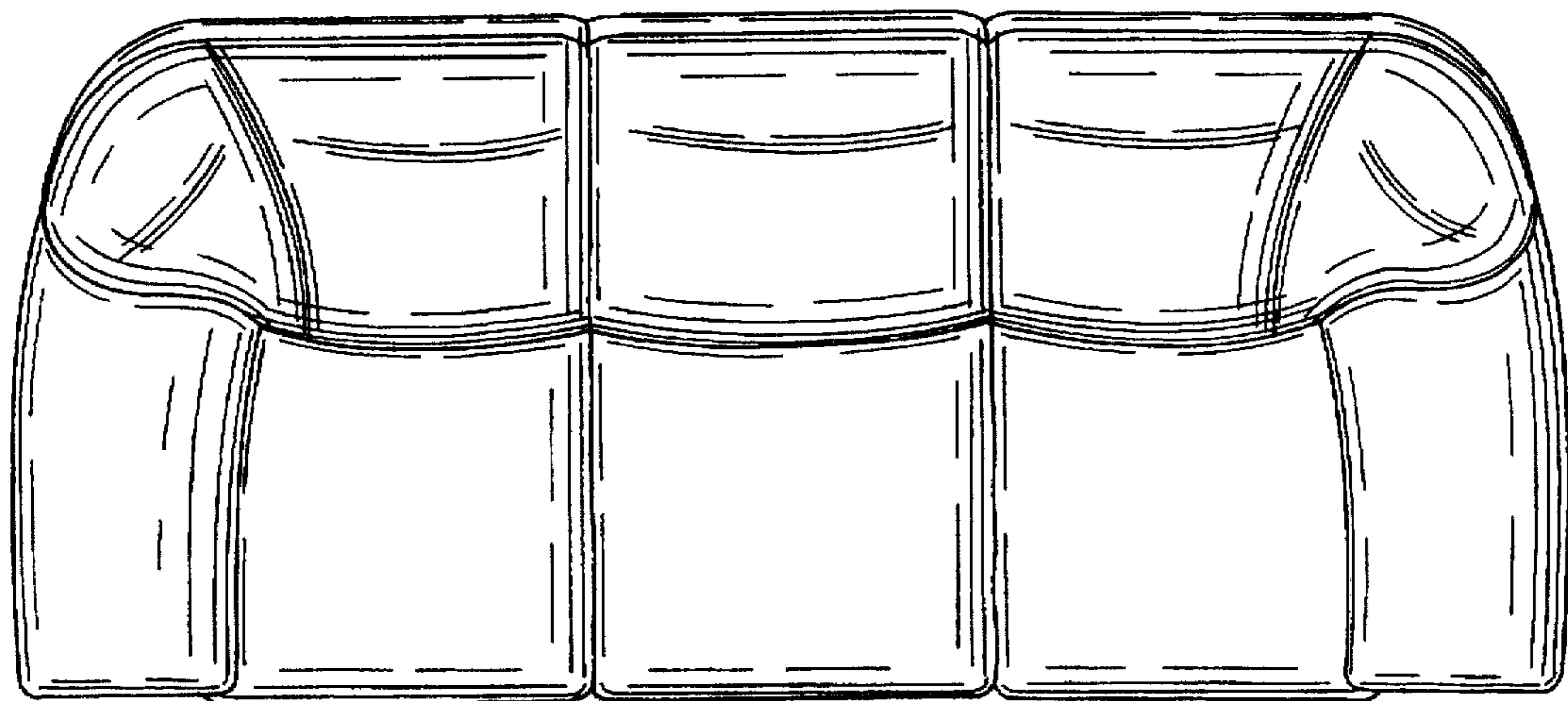

FIG. 3.

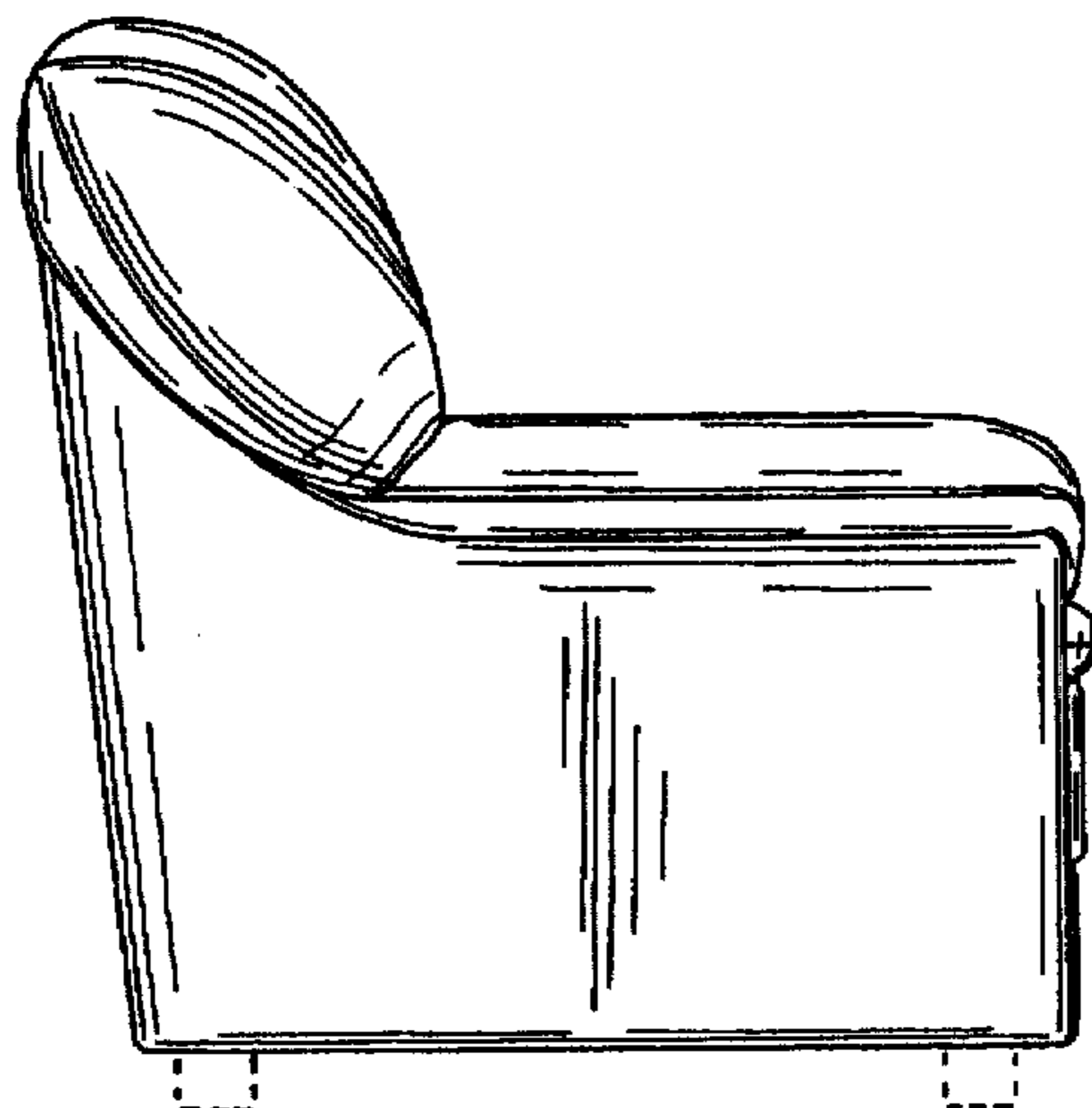

FIG. 4.

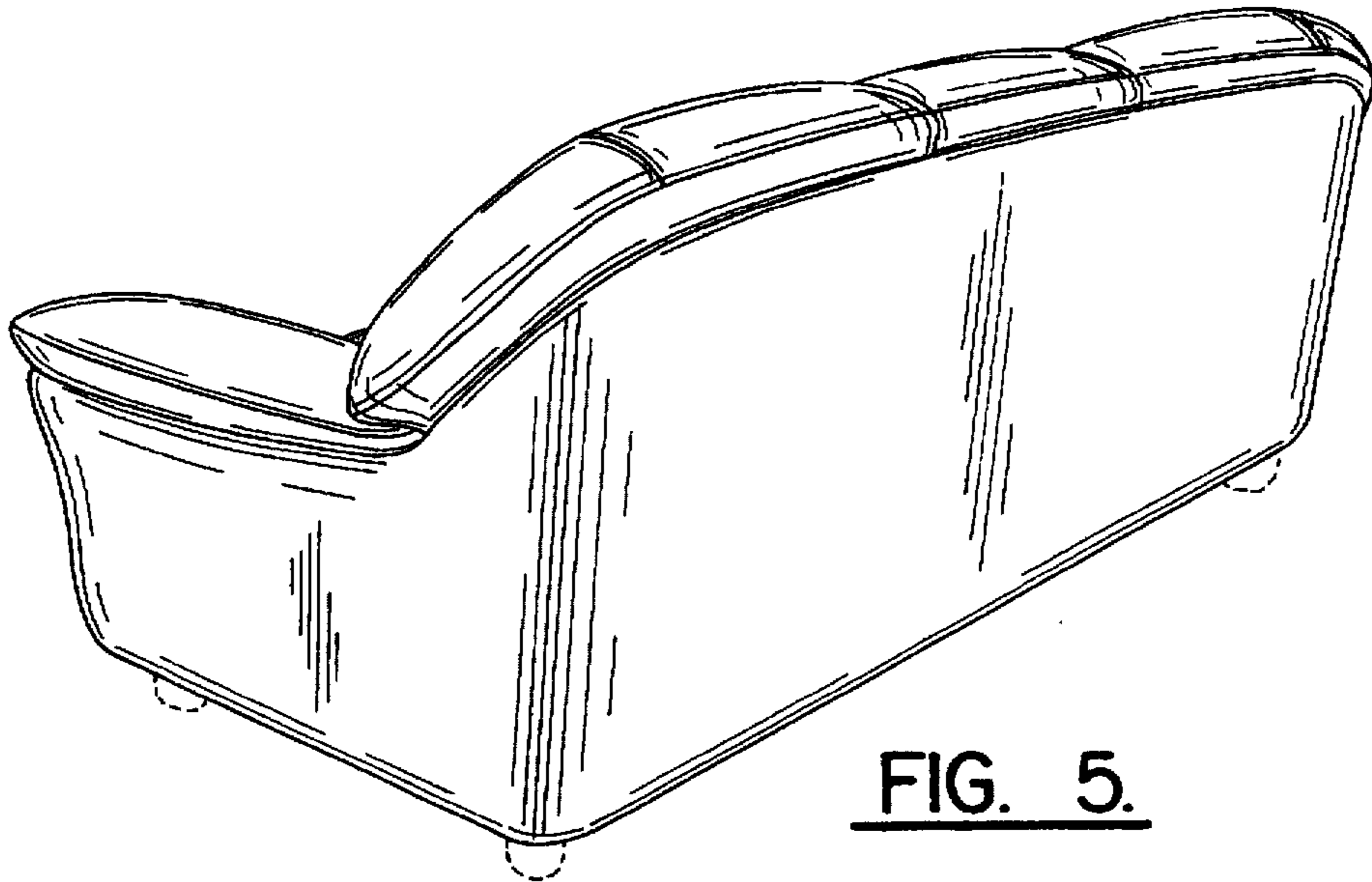

FIG. 5.

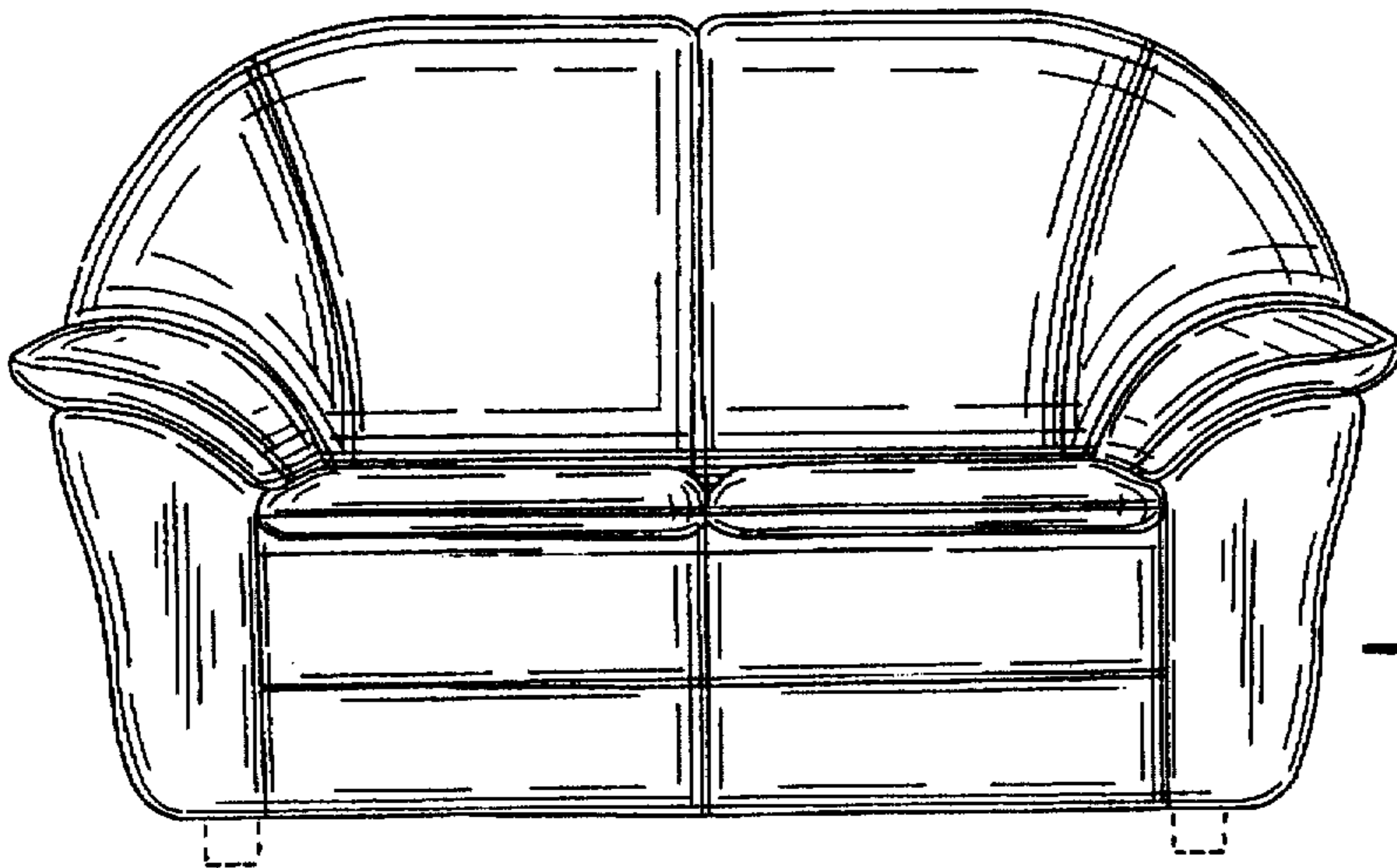

FIG. 6.

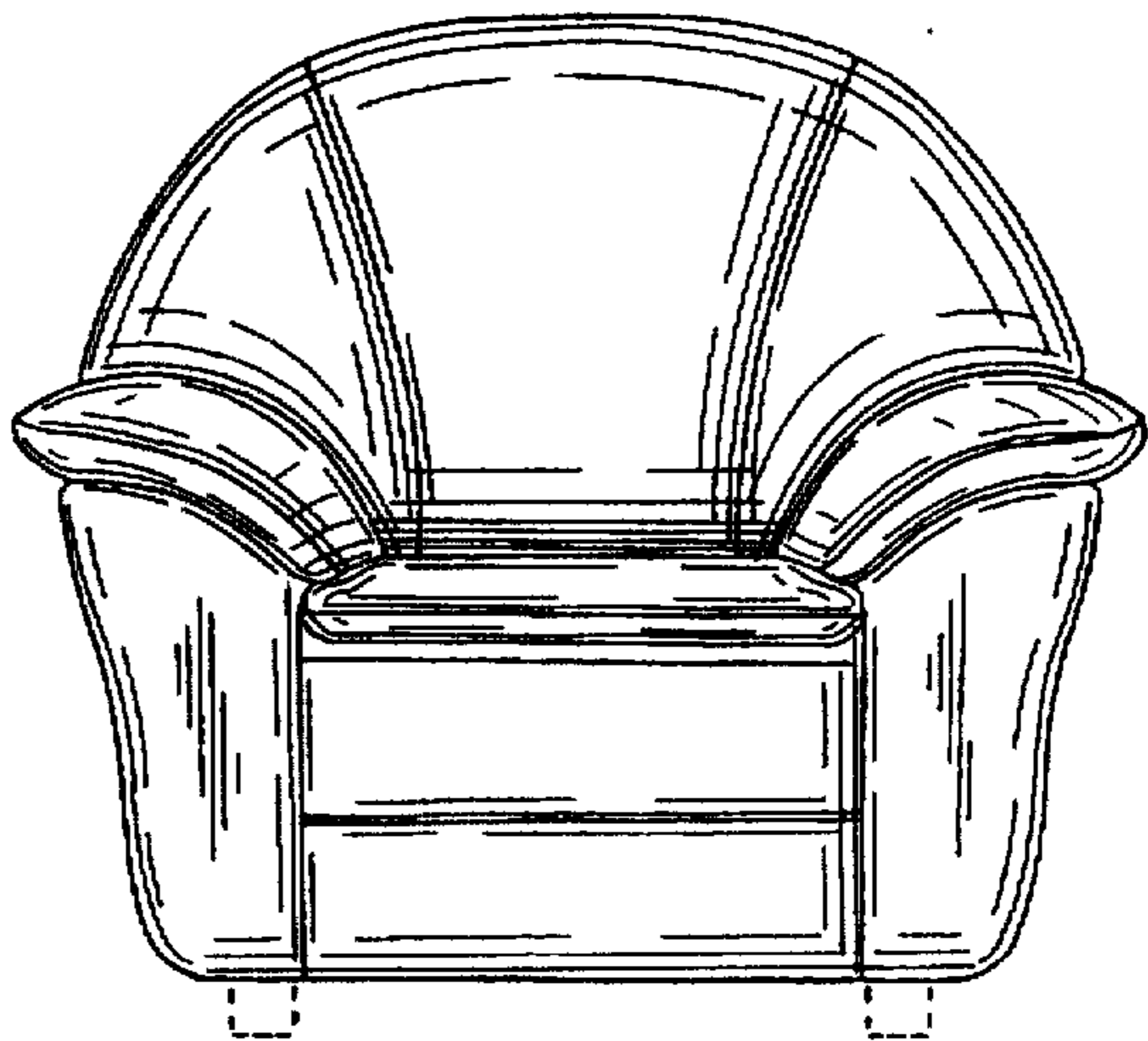

FIG. 7.