



US00D383967S

United States Patent [19]
DeMars

[11] **Patent Number: Des. 383,967**
[45] **Date of Patent: **Sep. 23, 1997**

[54] **UMBRELLA HOLDING CLAMP**

[76] **Inventor: Robert A. DeMars, 5000 N. Parkway Calabasas-Suite 233, Calabasas, Calif. 91302**

[**] **Term: 14 Years**

[21] **Appl. No.: 53,451**

[22] **Filed: Apr. 22, 1996**

[51] **LOC (6) Cl. 08-05**

[52] **U.S. Cl. D8/354**

[58] **Field of Search D8/349, 354, 383, D8/394, 396; 248/541; D6/416, 418**

[56] **References Cited**

U.S. PATENT DOCUMENTS

D. 345,814	4/1994	Wright, III	D8/396	X
640,446	1/1900	Converse	248/541	X
3,050,280	8/1962	Regan	248/541	X

OTHER PUBLICATIONS

Montrose Catalog, 1977, p. 225, needle protector bracket-item No. KSM-107 located at bottom of page.

Primary Examiner—Holly Baynham
Attorney, Agent, or Firm—Jack C. Munro

[57] **CLAIM**

The ornamental design for umbrella holding clamp, as shown and described.

DESCRIPTION

FIG. 1 is a front isometric view of the umbrella holding clamp showing my new design;

FIG. 2 is a top elevational view thereof;

FIG. 3 is a right side elevational view thereof;

FIG. 4 is a bottom view thereof;

FIG. 5 is a rear view thereof;

FIG. 6 is a front view thereof; and,

FIG. 7 is a fragmented isometric view of the second embodiment of the design shown in FIG. 1.

The undisclosed remaining portion of FIG. 7 is identical in appearance to the portions shown in the first embodiment and the view of FIG. 7 is shown fragmented for ease of illustration.

1 Claim, 1 Drawing Sheet

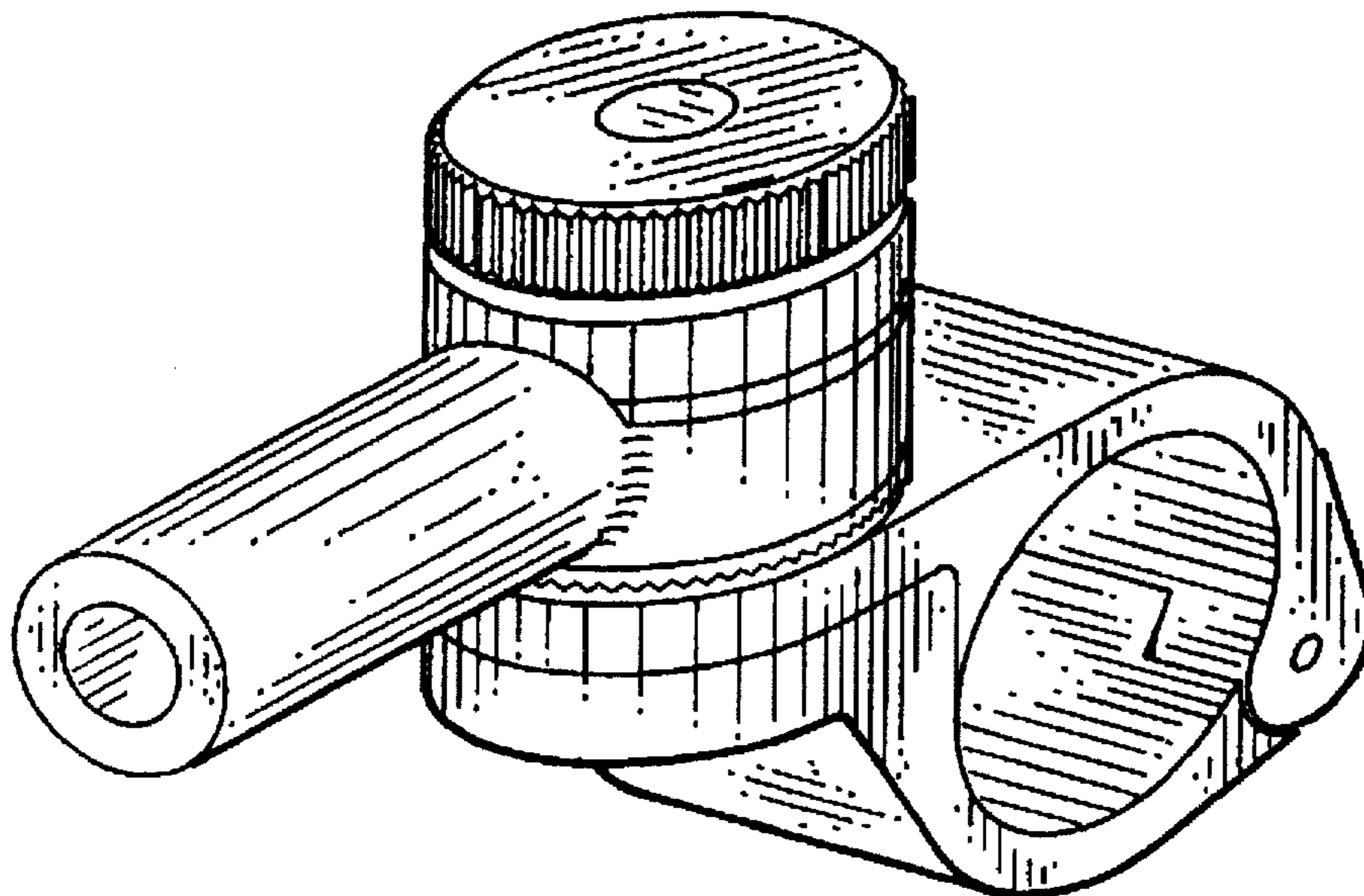

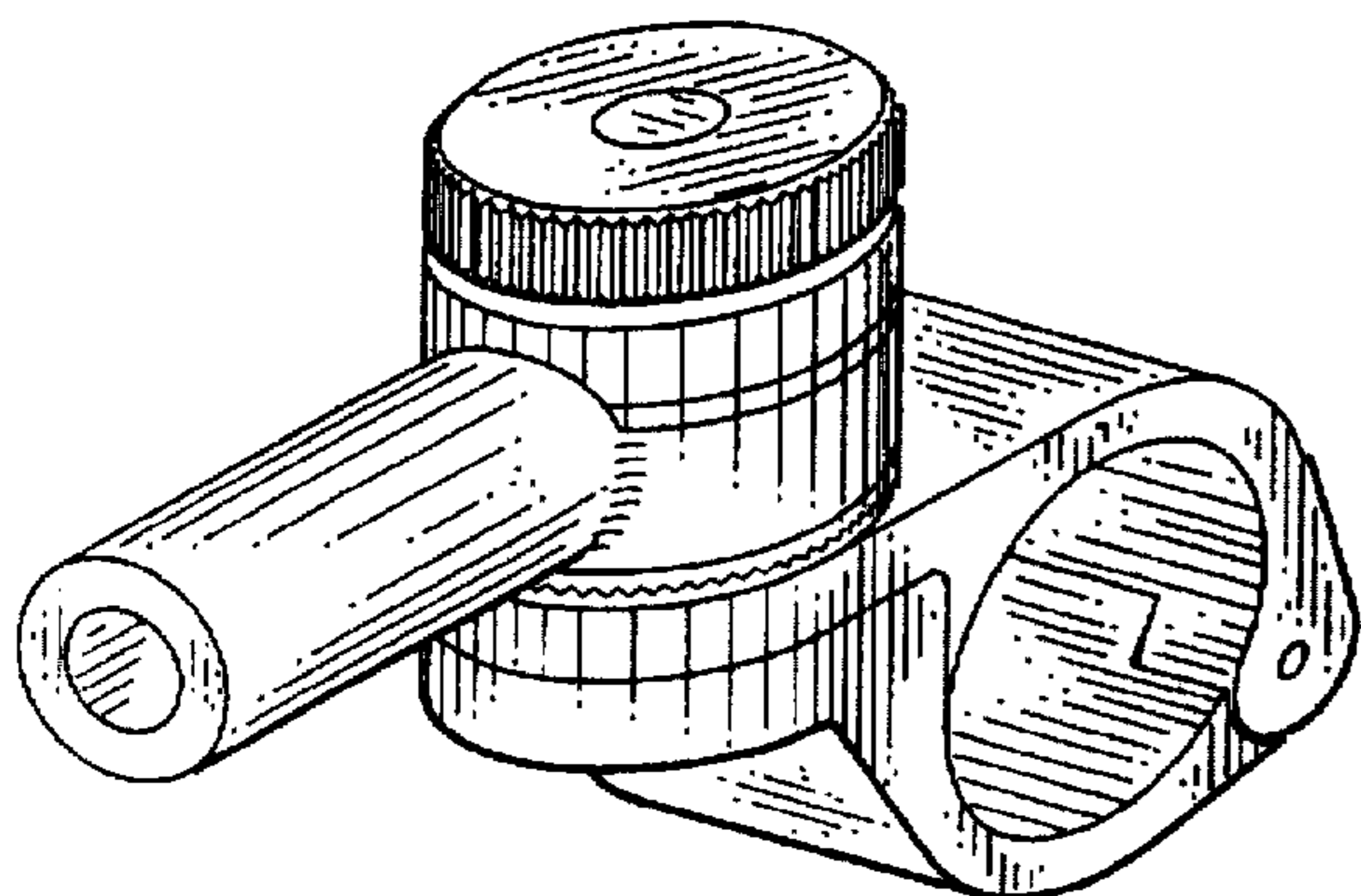

FIG. 1

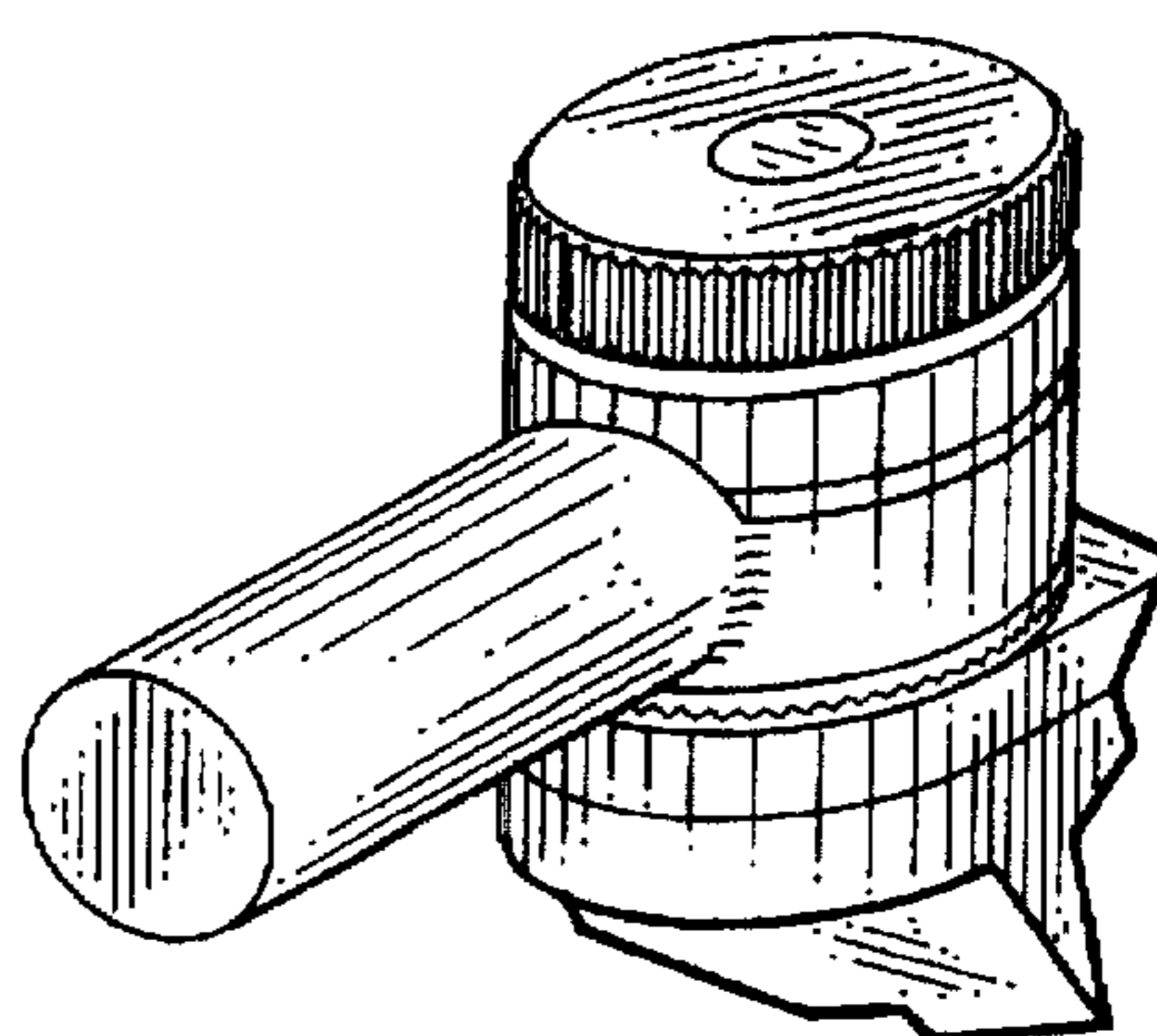

FIG. 7

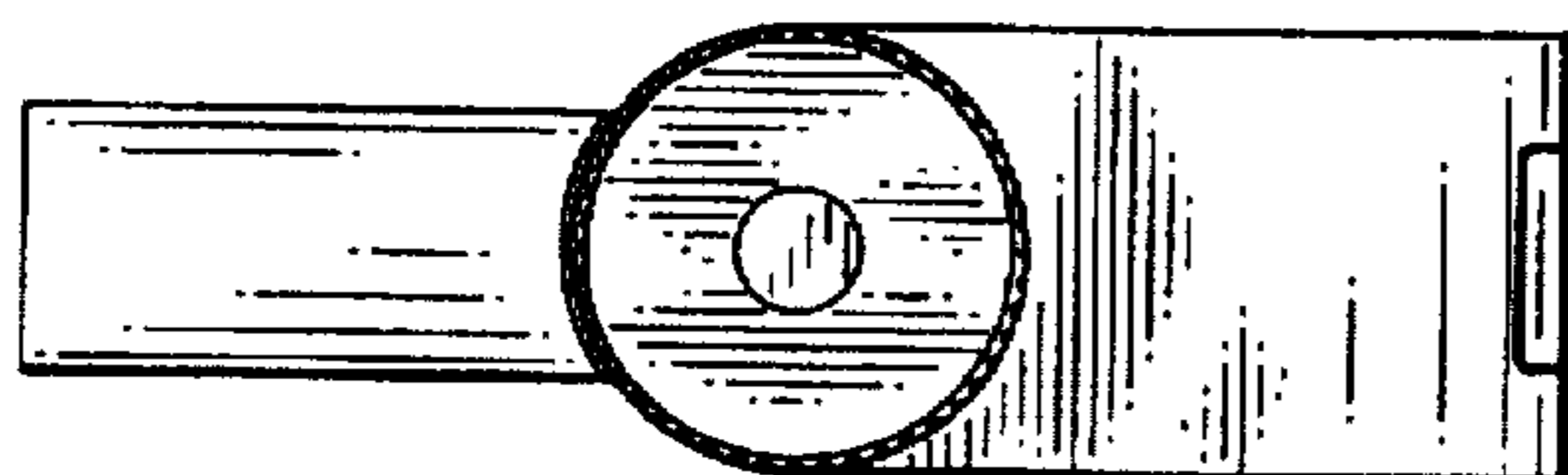

FIG. 2

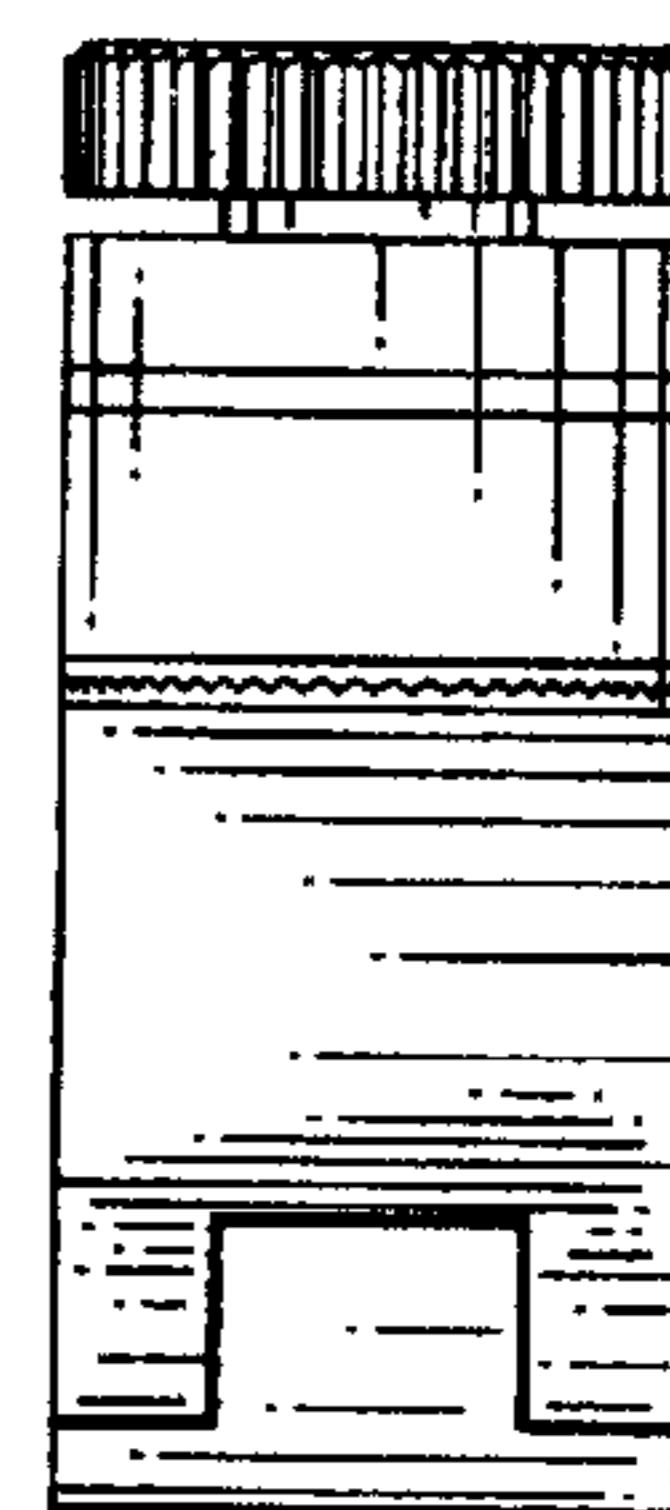

FIG. 5

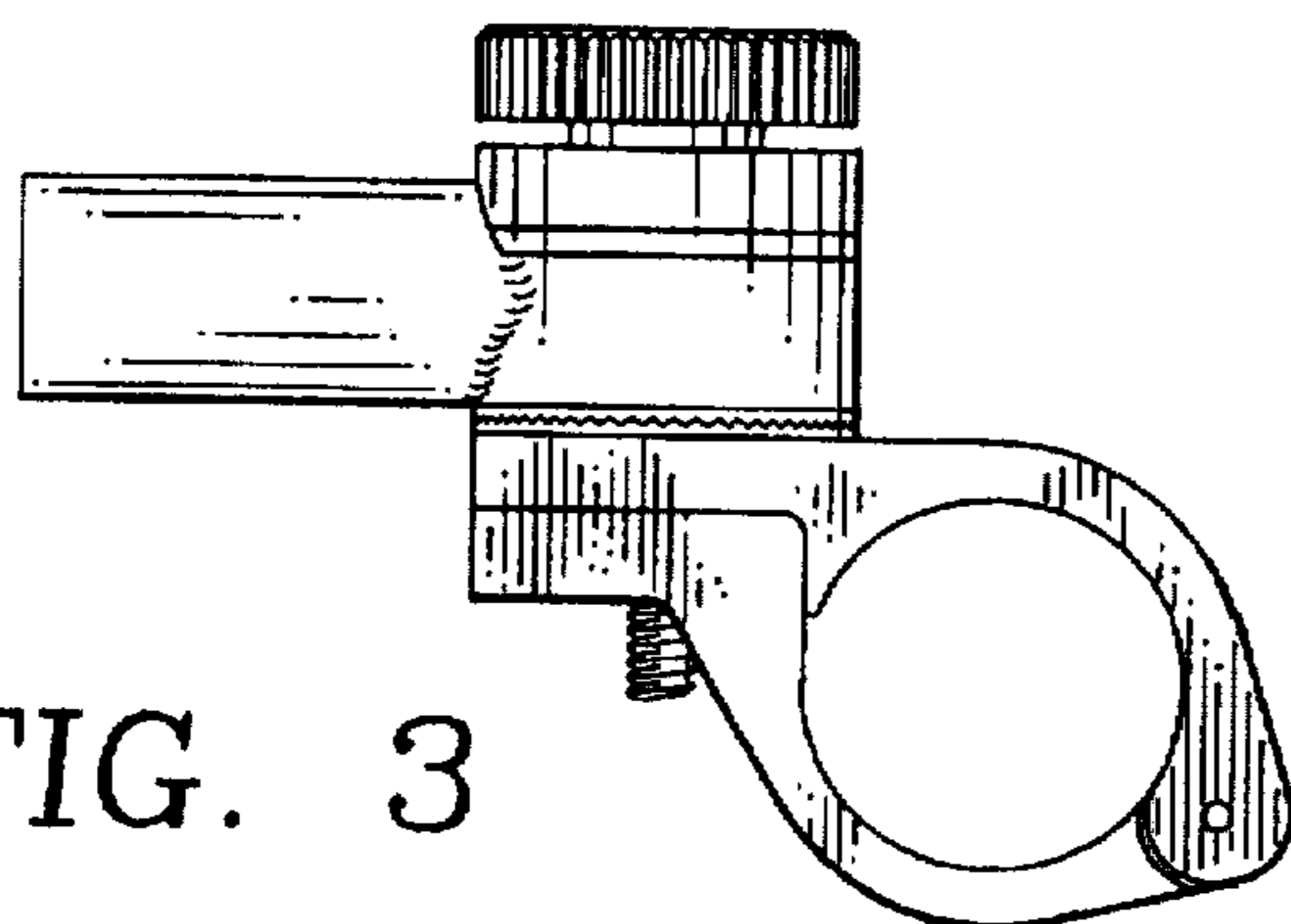

FIG. 3

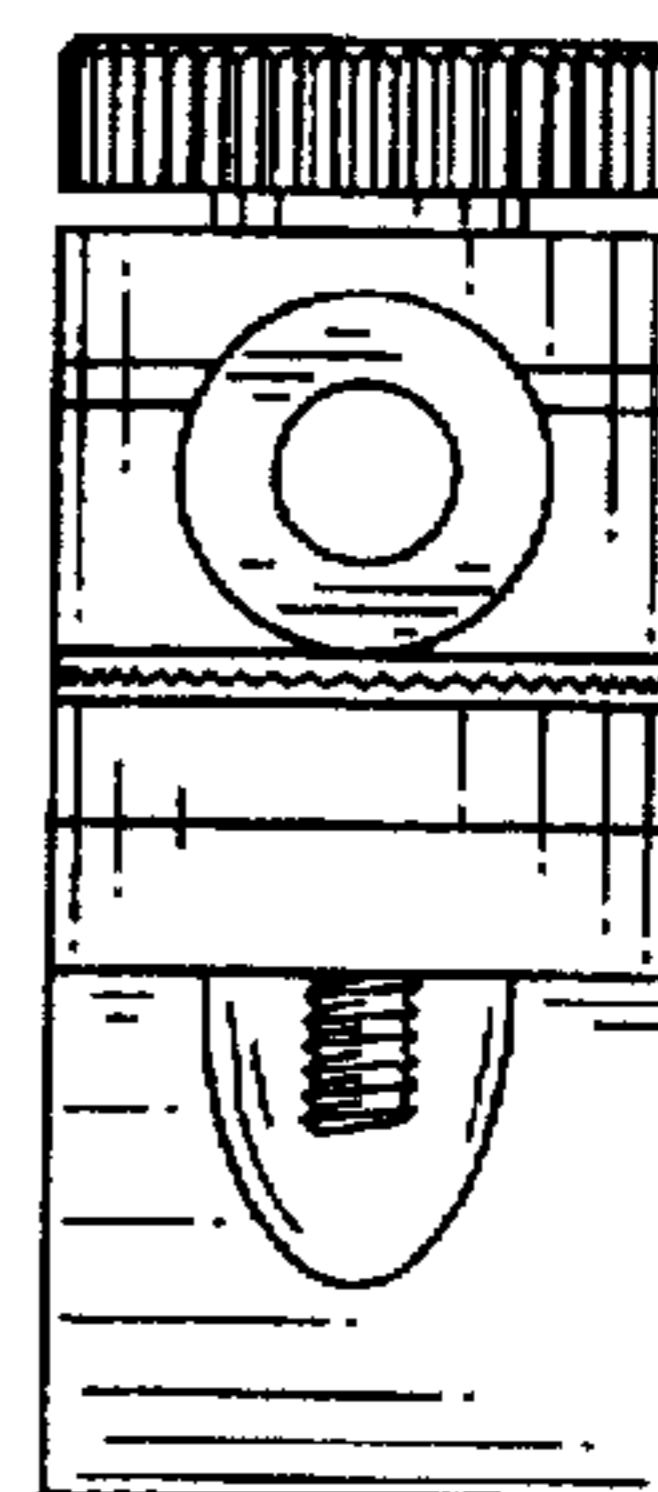

FIG. 6

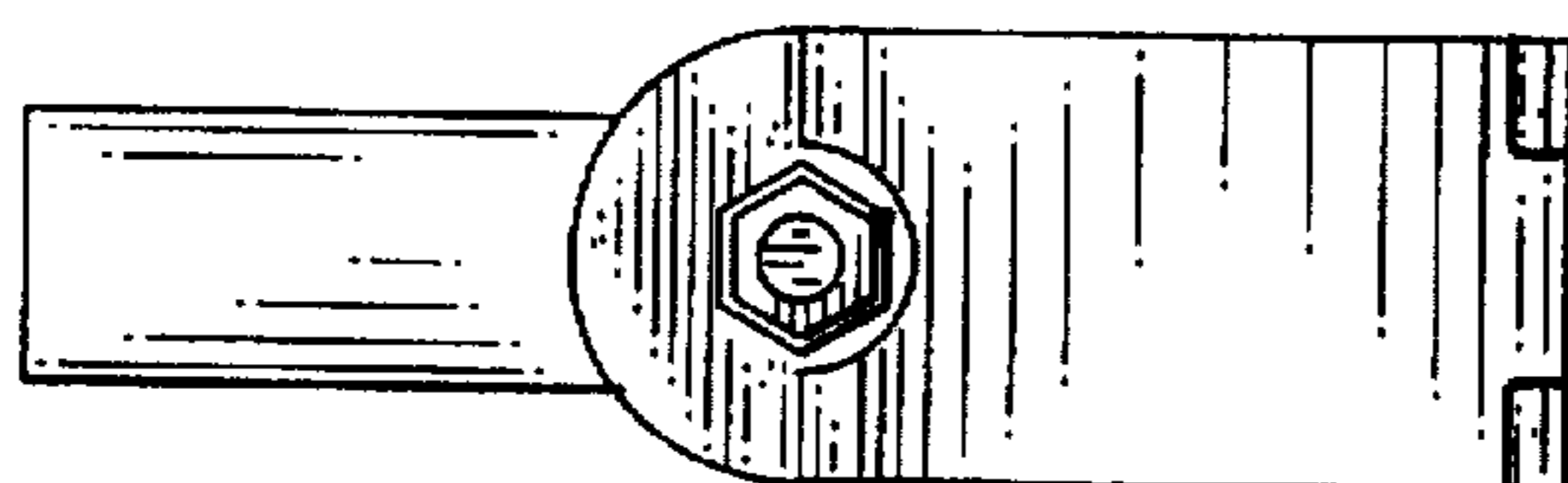

FIG. 4