

US00D383957S

United States Patent [19]
Cornell

[11] **Patent Number: Des. 383,957**
[45] **Date of Patent: **Sep. 23, 1997**

[54] **SCISSORS**
[75] **Inventor: Robert W. Cornell, Schofield, Wis.**
[73] **Assignee: Fiskars Inc., Madison, Wis.**
[**] **Term: 14 Years**

3,987,542 10/1976 Visco 30/233
4,074,430 2/1978 Sugiyama 30/260
5,341,573 8/1994 Linden et al. 30/254
5,379,521 1/1995 Lynders 30/233

[21] **Appl. No.: 47,807**
[22] **Filed: Nov. 6, 1995**

OTHER PUBLICATIONS

No. 86630, front and back view.
Wing Kwong Scissors Factory, Ltd., Items S811 and S900,
HKE Mar. 1989, p. 362.
Office Products, Item 113-C "Straight Trimmers", p. 310.
Flyer, "Scissors Molded to your Hand", 1 page, (Sep. 10,
1975).

Related U.S. Application Data

[63] **Continuation-in-part of Ser. No. 28,298, Sep. 12, 1994, Pat.
No. Des. 363,866.**

Primary Examiner—Ted Shooman
Assistant Examiner—Adir Aronovich
Attorney, Agent, or Firm—Foley & Lardner

[51] **LOC (6) Cl. 08-03**
[52] **U.S. Cl. D8/57**
[58] **Field of Search D8/57; 30/230-232,
30/233, 254, 255; 7/125, 132, 134, 135,
151**

[57] **CLAIM**

The ornamental design for the scissors, as shown and
described.

[56] **References Cited**

DESCRIPTION

U.S. PATENT DOCUMENTS

FIG. 1 is a perspective view of a scissors showing my new
design;
FIG. 2 is a front elevational view thereof;
FIG. 3 is a top plan view thereof;
FIG. 4 is a bottom plan view thereof;
FIG. 5 is a left side elevational view thereof;
FIG. 6 is a right side elevational view thereof; and,
FIG. 7 is a rear elevational view thereof.
The broken line showing of the blades and fasteners is for
illustrative purposes only and forms no part of the claimed
design.

D. 254,420	3/1980	Bächjström	D8/57
D. 267,309	12/1982	Lindén	D8/57
D. 267,773	2/1983	Lindén	D8/57
D. 272,227	1/1984	Linden et al.	D8/57
D. 277,450	2/1985	Hayashi	D8/57
D. 316,802	5/1991	Yamagishi	D8/57
D. 318,780	8/1991	Bendickson et al.	D8/57
D. 344,225	2/1994	Hendon et al.	D8/57
D. 358,748	5/1995	Ramsey et al.	D8/57
1,131,504	3/1915	Garen	7/135
2,682,108	6/1954	Shaler	30/230
3,913,422	10/1975	Weber	D8/57

1 Claim, 2 Drawing Sheets

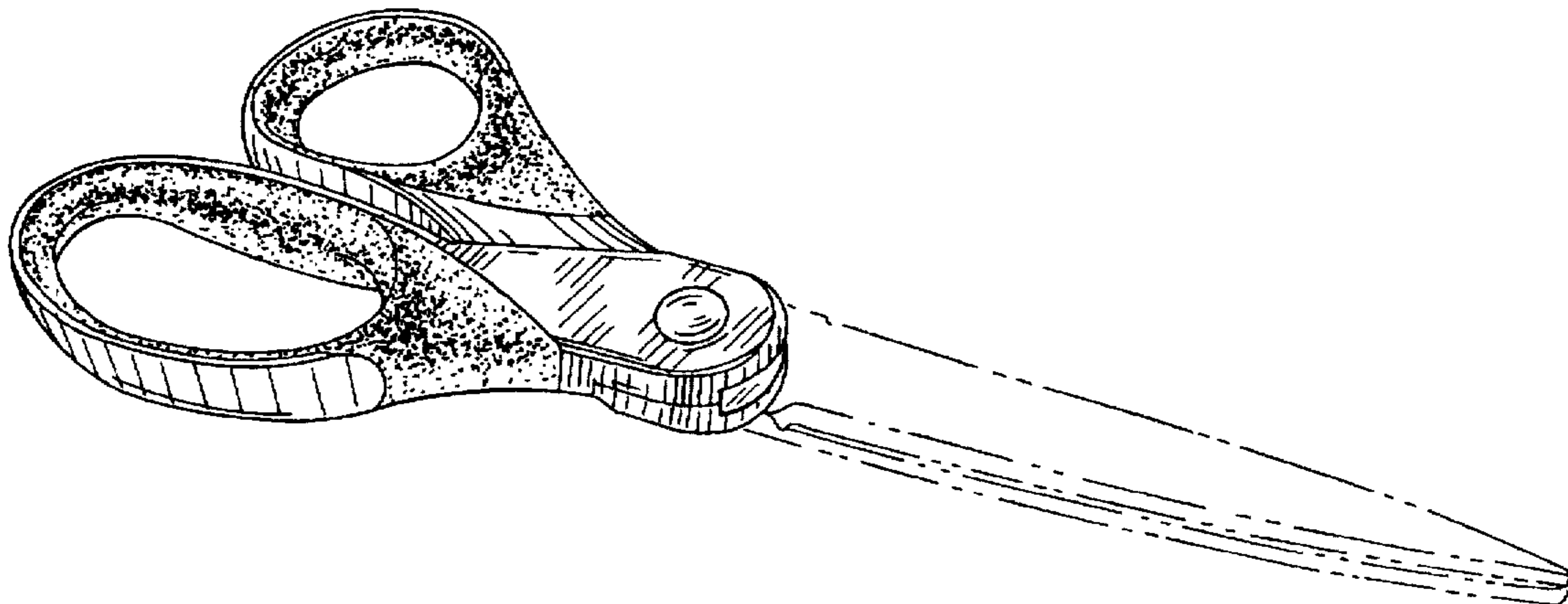

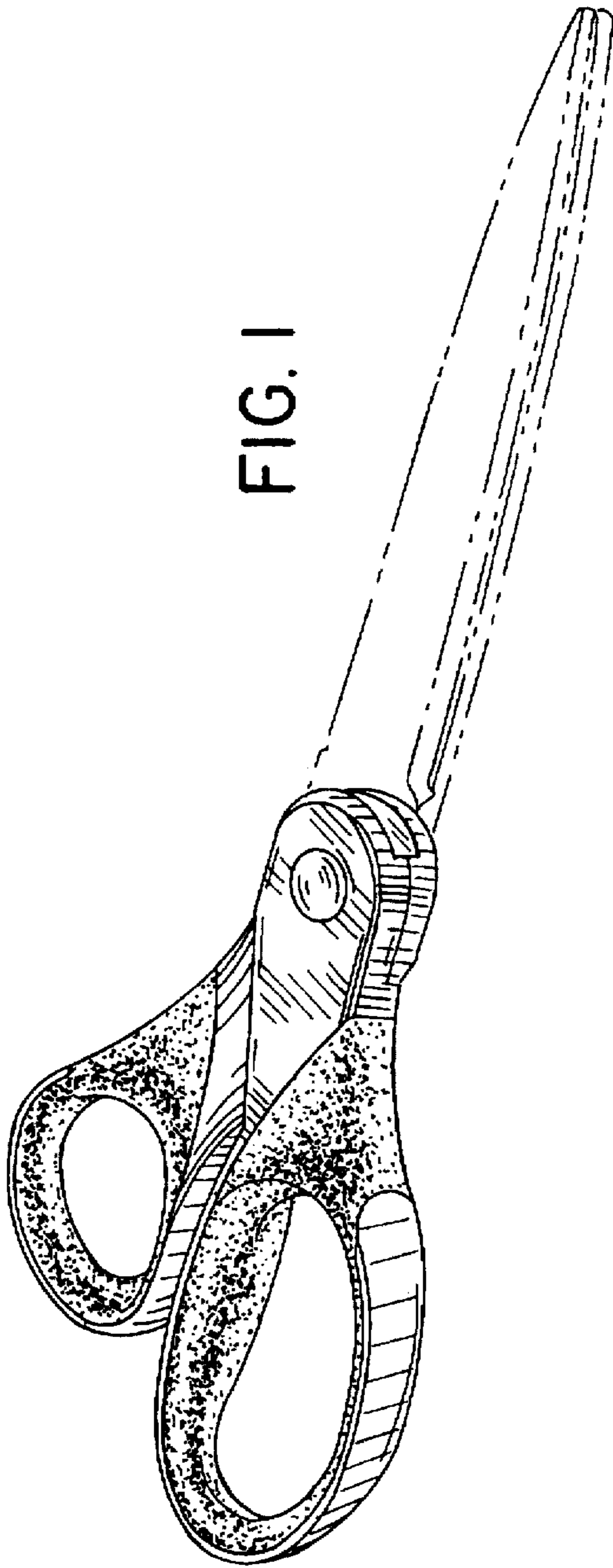

FIG. 1

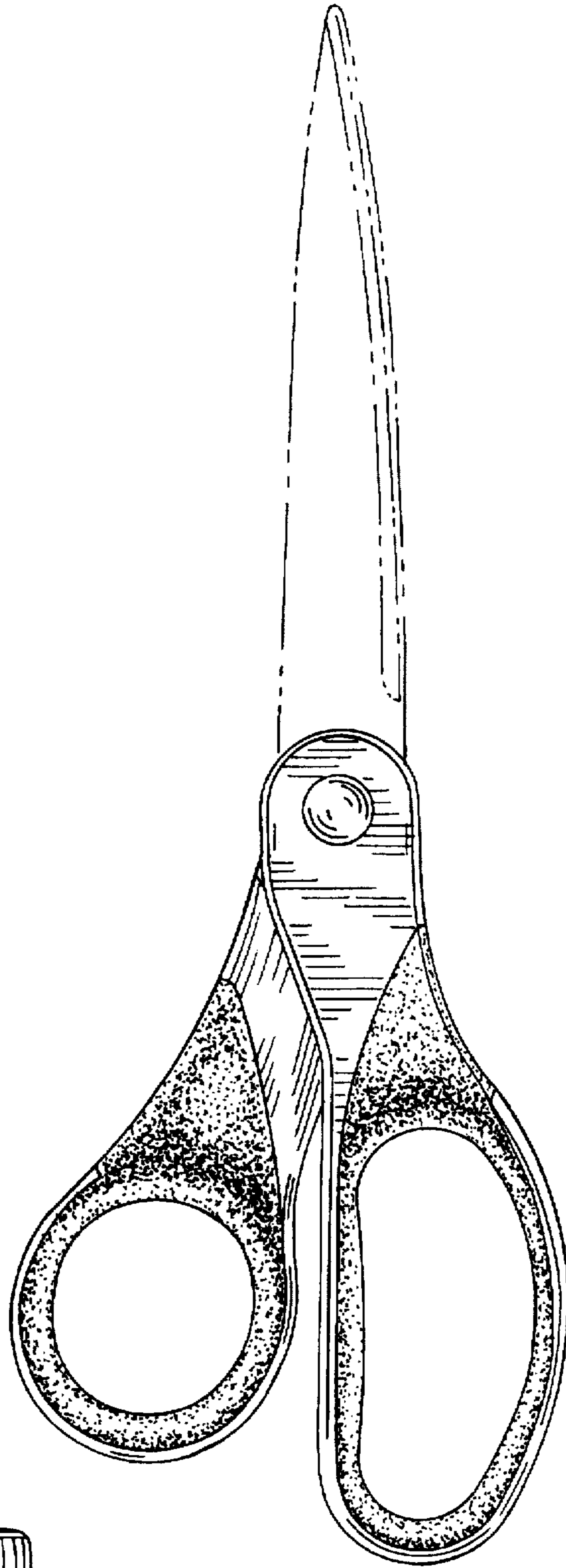

FIG. 3

FIG. 6

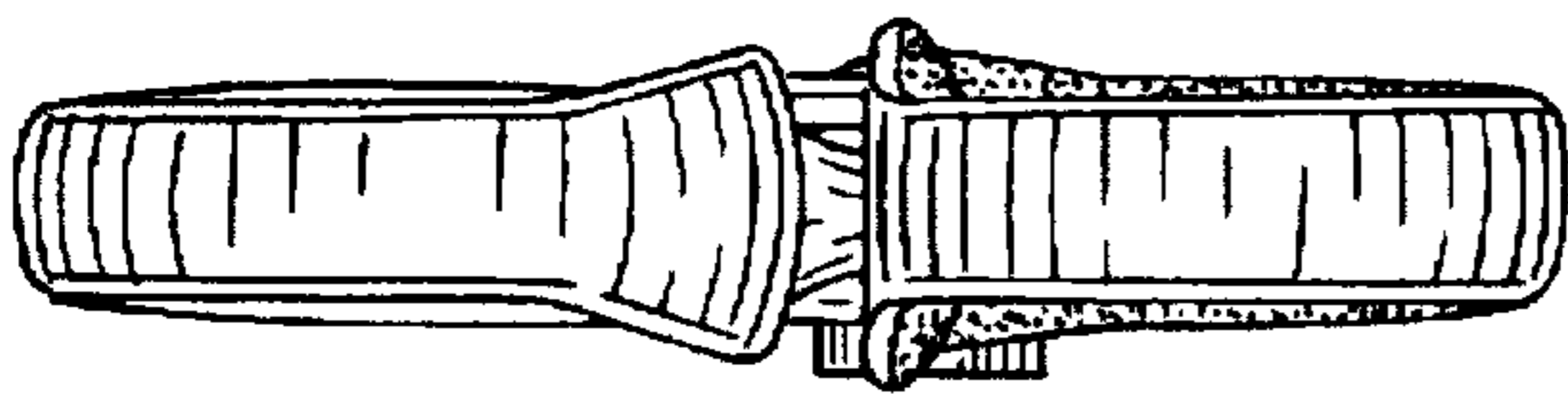

FIG. 4

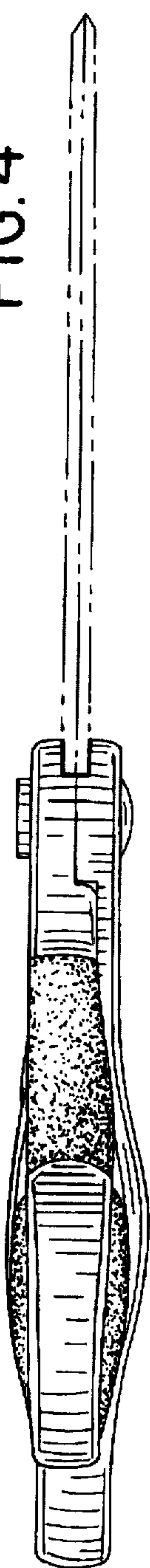

FIG. 5

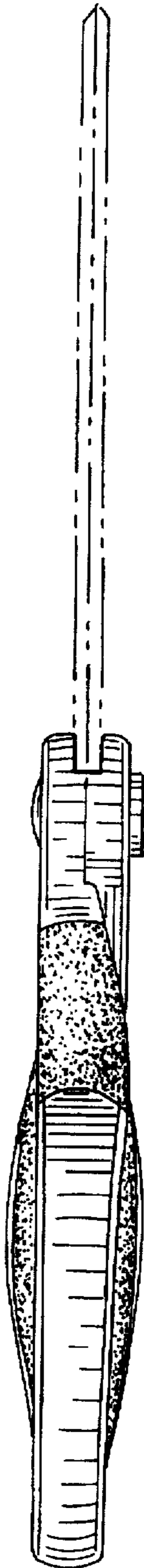

FIG. 2

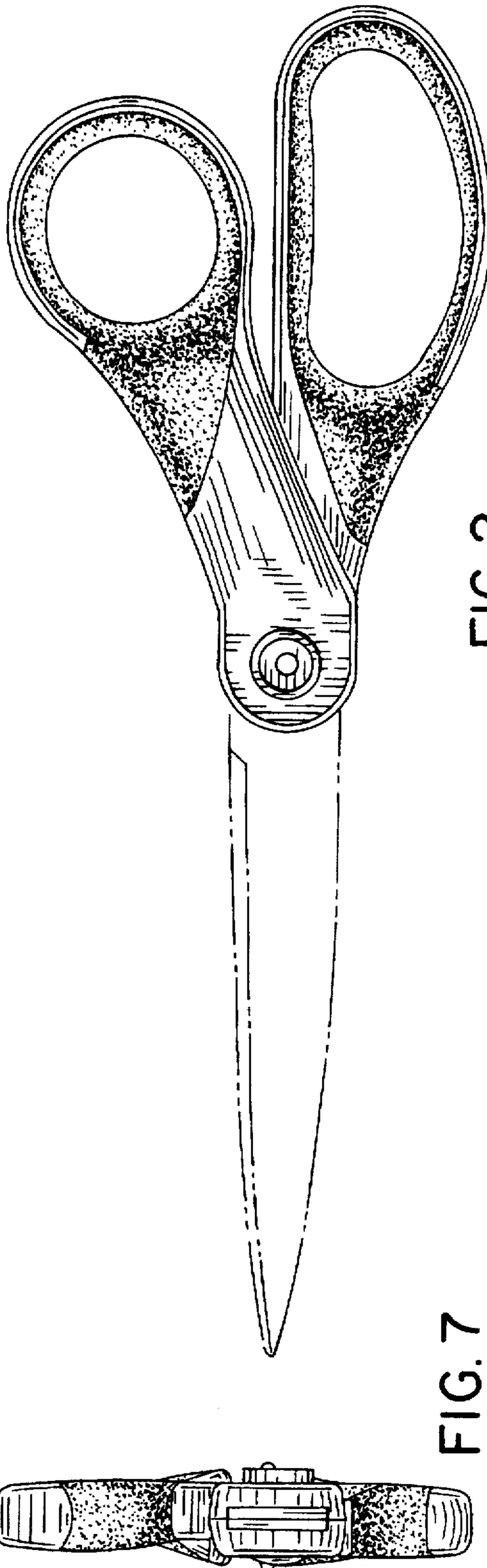

FIG. 7

