



US00D383899S

United States Patent [19]

[11] Patent Number: **Des. 383,899**

Rhee

[45] Date of Patent: ****Sep. 23, 1997**

[54] **STAND FOR GOLF BAG**

[76] Inventor: **Yong Su Rhee**, 138-26 Yun Hui 2nd Dong, Seo Dae Moon-Ku, Seoul, Rep. of Korea, 120-112

[**] Term: **14 Years**

[21] Appl. No.: **26,340**

[22] Filed: **Jul. 25, 1994**

[30] **Foreign Application Priority Data**

Mar. 15, 1994 [KR] Rep. of Korea 4886

[51] **LOC (6) Cl.** **03-99**

[52] **U.S. Cl.** **D3/320**

[58] **Field of Search** D3/255; 206/315.1, 206/315.2, 315.3, 315.4, 315.5, 315.6, 315.7, 315.8, 315.9

[56] **References Cited**

U.S. PATENT DOCUMENTS

1,840,663	1/1932	Gallagher	206/315.6
1,960,099	5/1934	Donovan	240/96
2,305,517	12/1942	Cox	248/96
3,758,061	9/1973	Townhill	248/96
3,787,017	1/1974	Saver	206/315.7 X
4,506,854	3/1985	Kim	248/96
4,676,464	6/1987	Reimers	248/96
4,921,192	5/1990	Jones	248/96
4,949,844	8/1990	Yang	206/315.7
5,147,089	9/1992	Anderson	248/96
5,152,483	10/1992	Maeng	248/96

(List continued on next page.)

OTHER PUBLICATIONS

The Golf Store Catalogue from Golfsmith, Apr. 1994, Nos. 366,368 and 369.

The Golf Store Catalogue from Golfsmith, Jun. 1994, p. 44, Nos. 366, 368 and 369.

Best! Products Catalogue, 1993 1994, p. 438, No. 12.

Golf Day, Catalog, No. 116A, pp. 12 and 28, Nos. 400-020, 400 021, 147-071, 516 200 and 575-001.

Primary Examiner—Louis S. Zarfes
Assistant Examiner—Catherine R. Oliver
Attorney, Agent, or Firm—Fisher, Christen, & Sabol

[57] **CLAIM**

The ornamental design for the stand for a golf bag, as shown and described.

DESCRIPTION

FIG. 1 is a front perspective view of the stand for a golf bag showing my new design;

FIG. 2 is a right side elevational view including the curved push rod;

FIG. 3 is a right side view, with the stand in an open extended position;

FIG. 4 is a bottom plan view;

FIG. 5 is a top plan view;

FIG. 6 is a rear elevational view;

FIG. 7 is a left side elevational view, including the curved push rod;

FIG. 8 is a front elevational view;

FIG. 9 is a front perspective view of a second embodiment;

FIG. 10 is a front perspective view of a third embodiment;

FIG. 11 is a right side elevational view of the second embodiment;

FIG. 12 is a right side view of the second embodiment, with the stand in an open extended position;

FIG. 13 is a bottom plan view of the second embodiment;

FIG. 14 is a top plan view thereof;

FIG. 15 is a rear elevational view thereof;

FIG. 16 is a left side elevational view thereof;

FIG. 17 is a front elevational view thereof;

FIG. 18 is a right side elevational view of a third embodiment;

FIG. 19 is a right side view thereof, with the stand in an open extended position;

FIG. 20 is a bottom plan view thereof;

FIG. 21 is a top plan view thereof;

FIG. 22 is a rear elevational view thereof;

FIG. 23 is a left side elevational view thereof; and,

FIG. 24 is a front elevational view.

The broken line showing of a golf bag is for illustrative purposes only and forms no part of the claimed design.

1 Claim, 7 Drawing Sheets

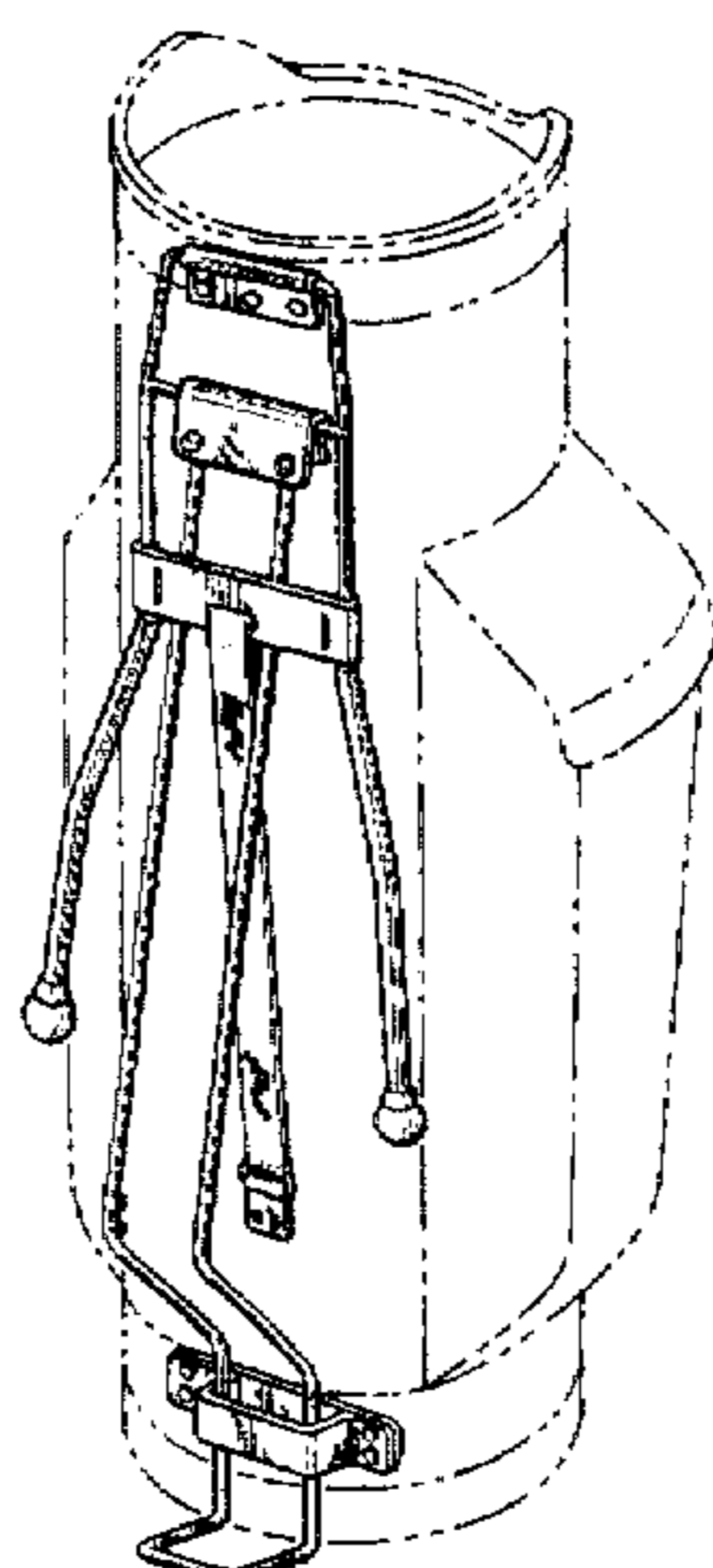

U.S. PATENT DOCUMENTS						
			5,303,888	4/1994	Seop	248/96
			5,314,150	5/1994	Seop	248/96
5,154,377	10/1992	Suk	5,339,951	8/1994	Chen	206/315.7
5,156,366	10/1992	Anderson	5,340,062	8/1994	Hsieh	206/315.7 X
5,178,273	1/1993	Igarashi	5,390,788	2/1995	Schenkkan	206/315.6 X
5,209,350	5/1993	Maeng	5,407,155	4/1995	Chung	206/315.7 X
5,236,085	8/1993	Quellais				

FIG. 1

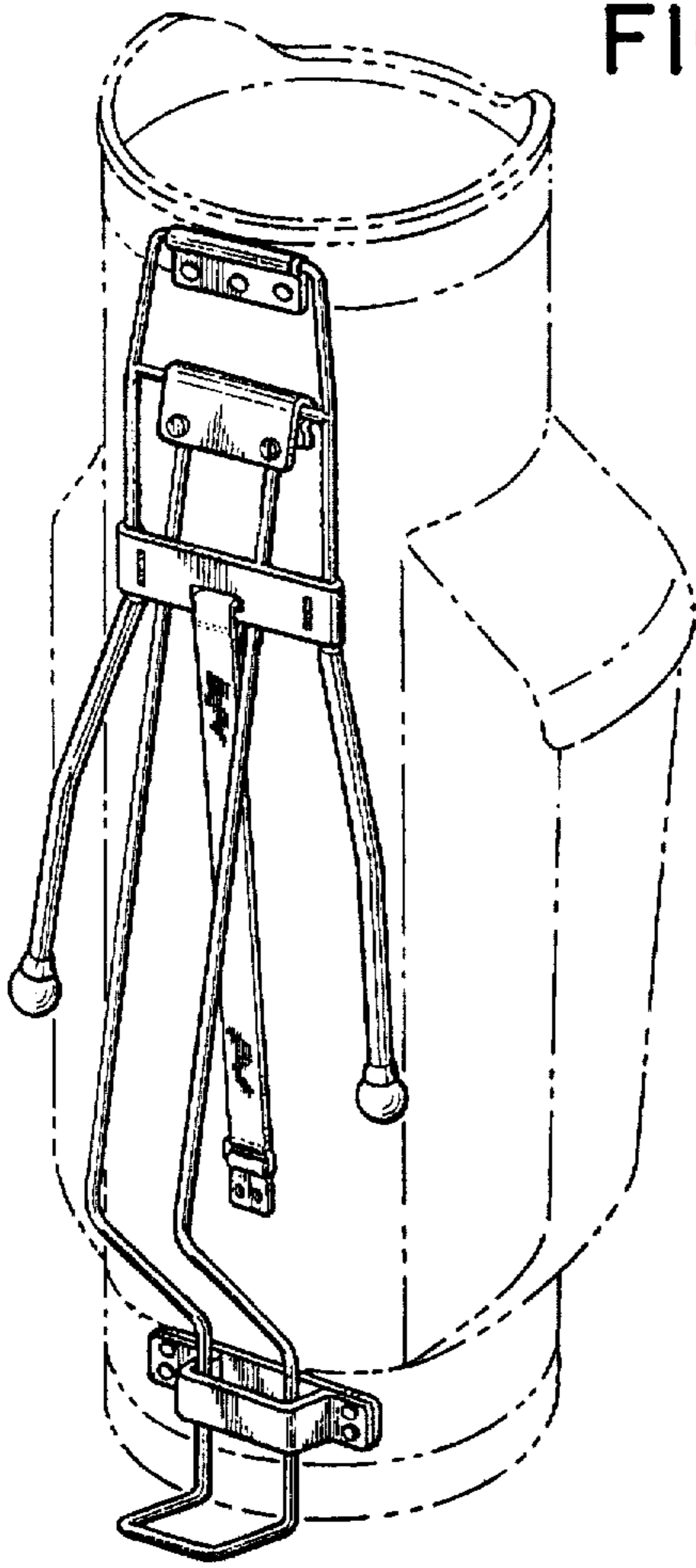

FIG. 2

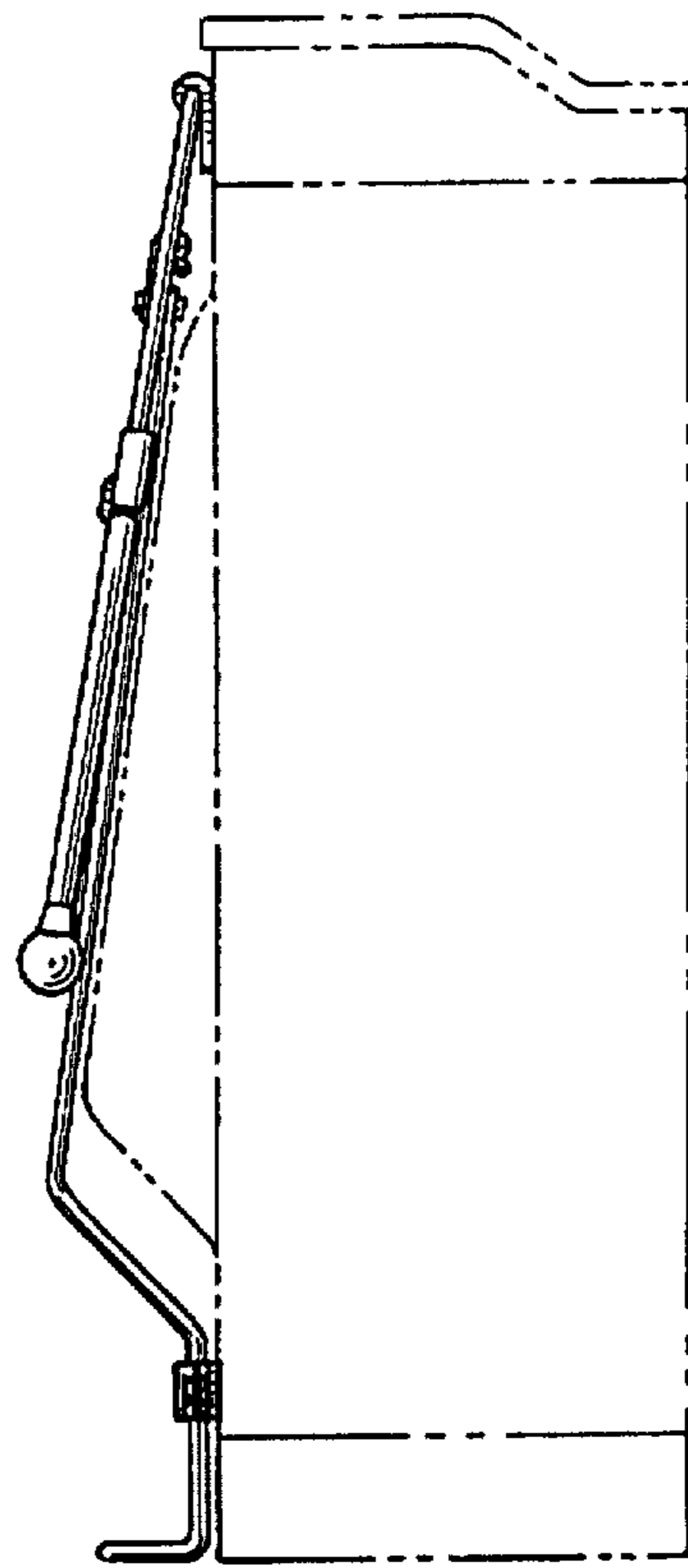

FIG. 3

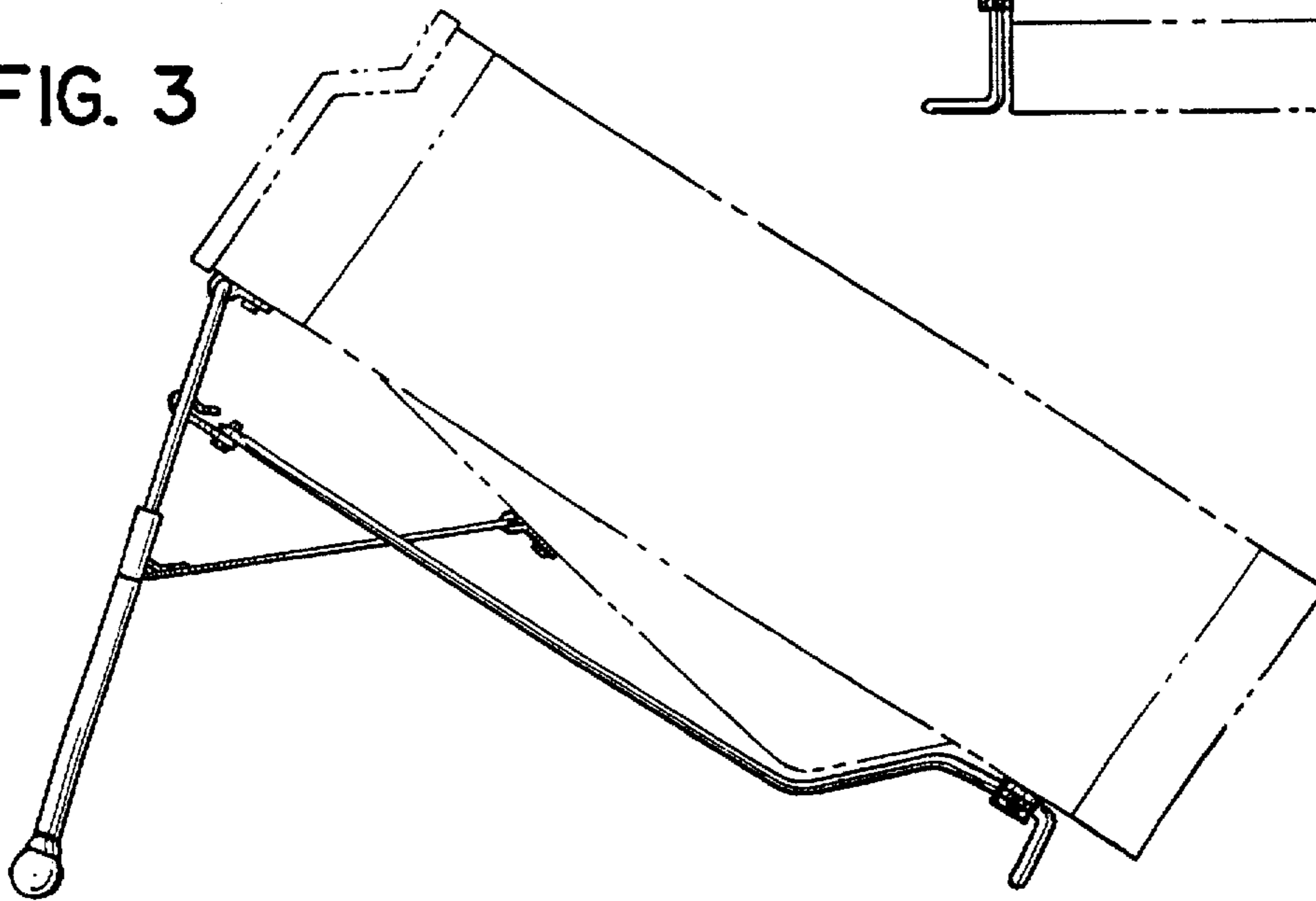

FIG. 4

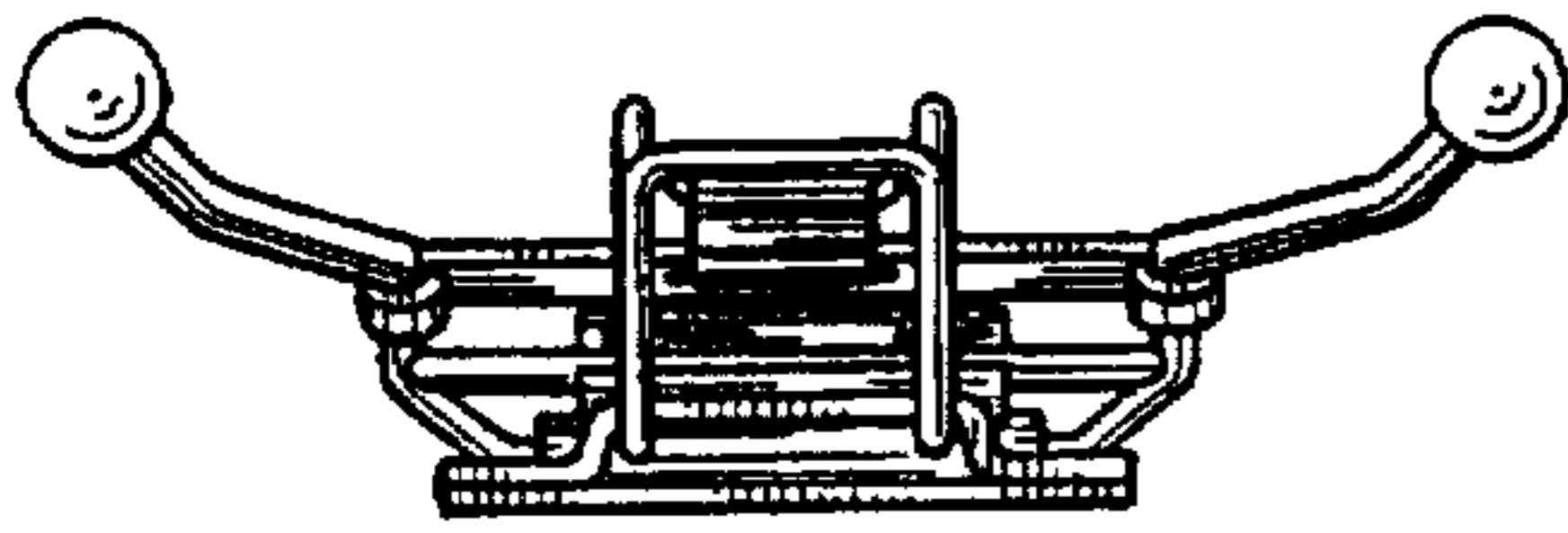

FIG. 5

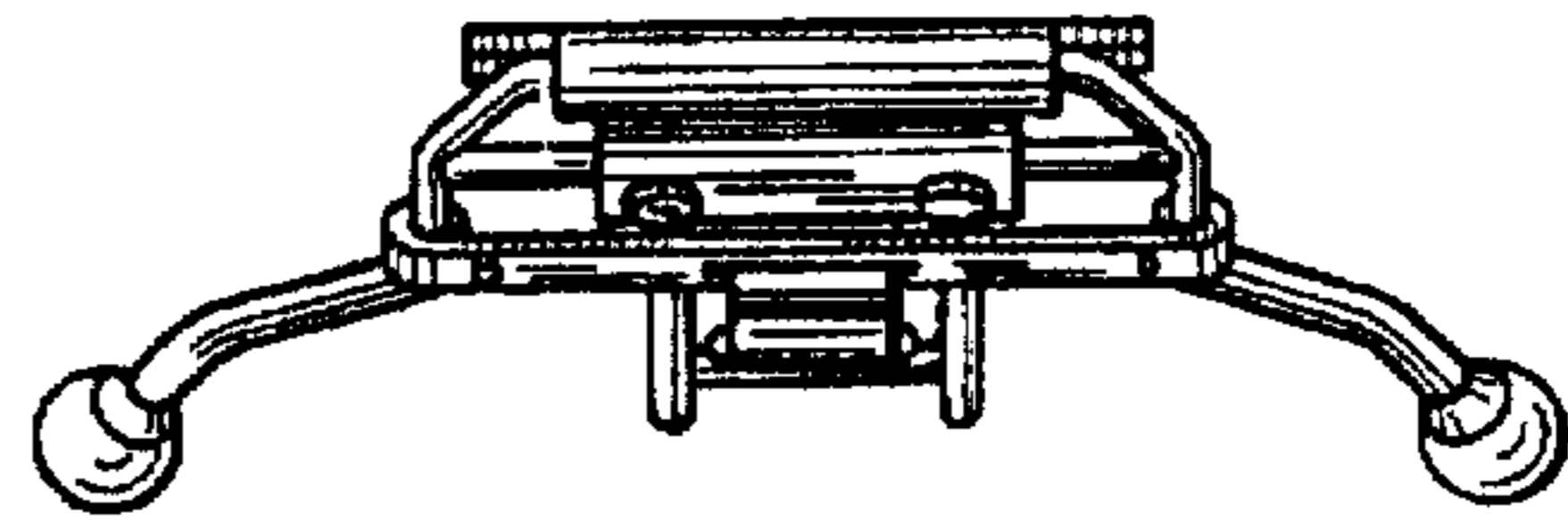

FIG. 6

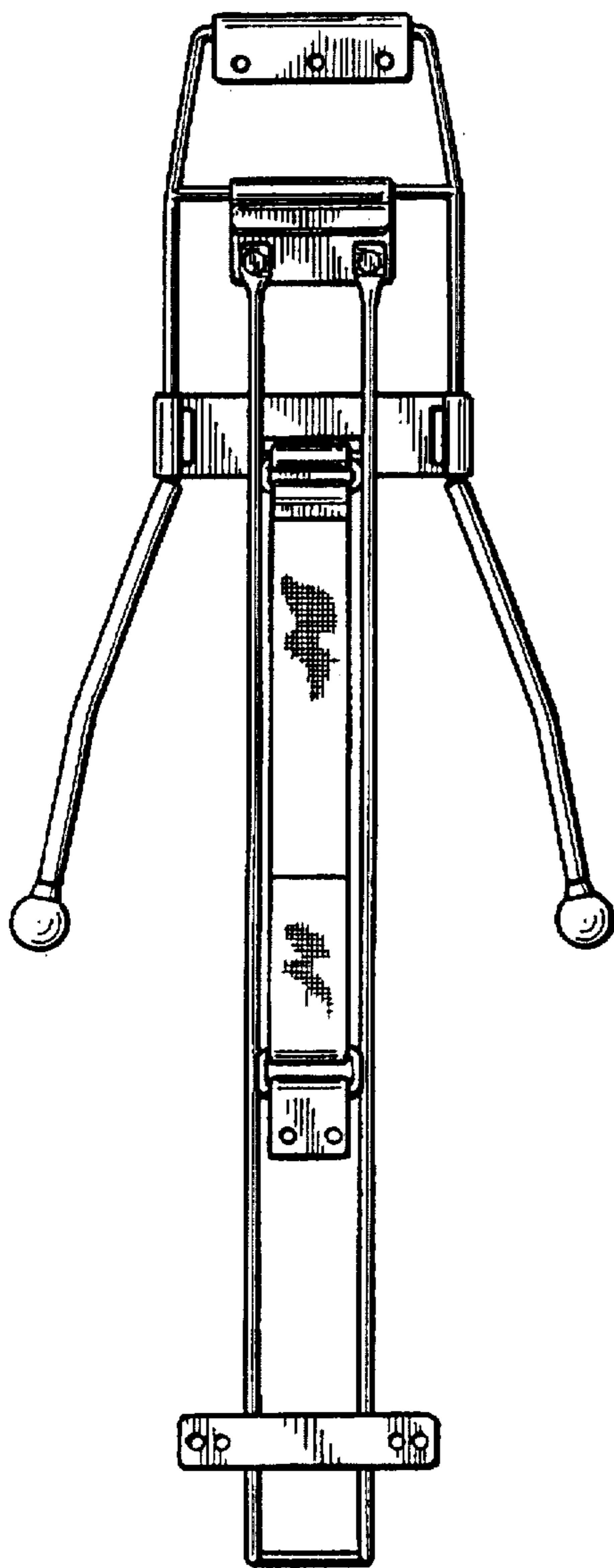

FIG. 7



FIG. 8

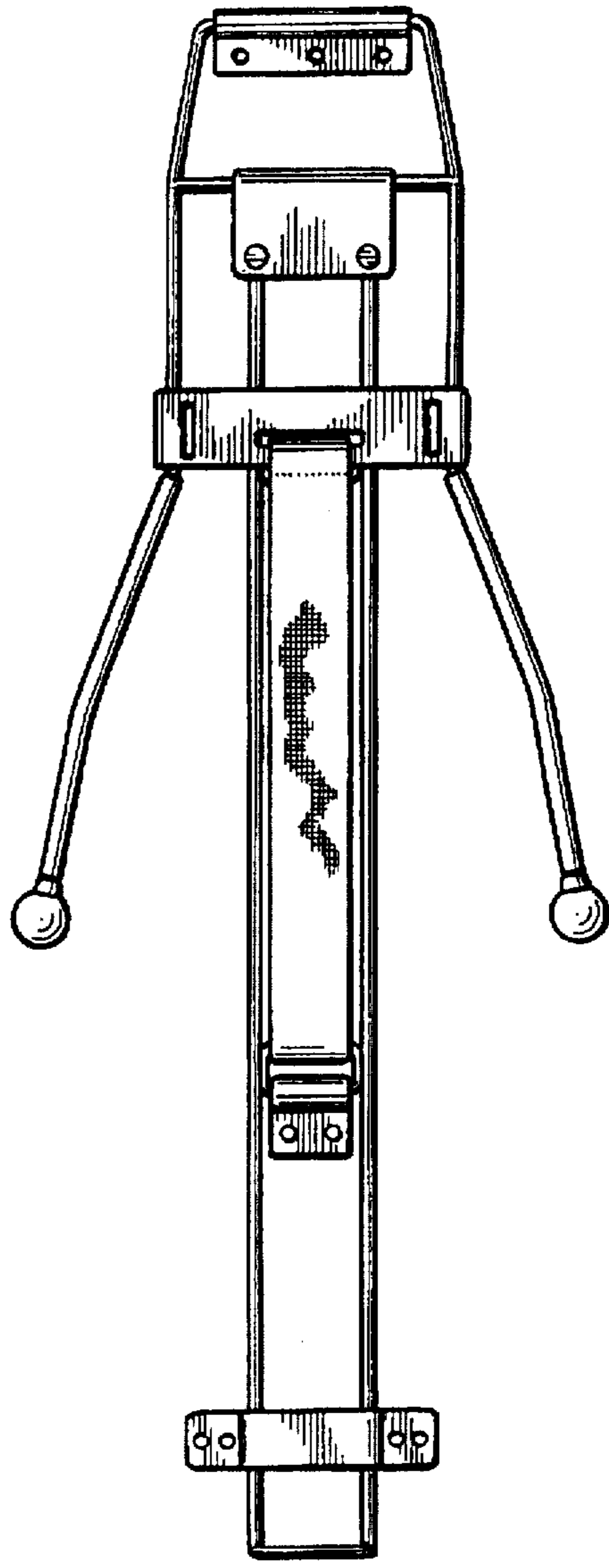

FIG. 10

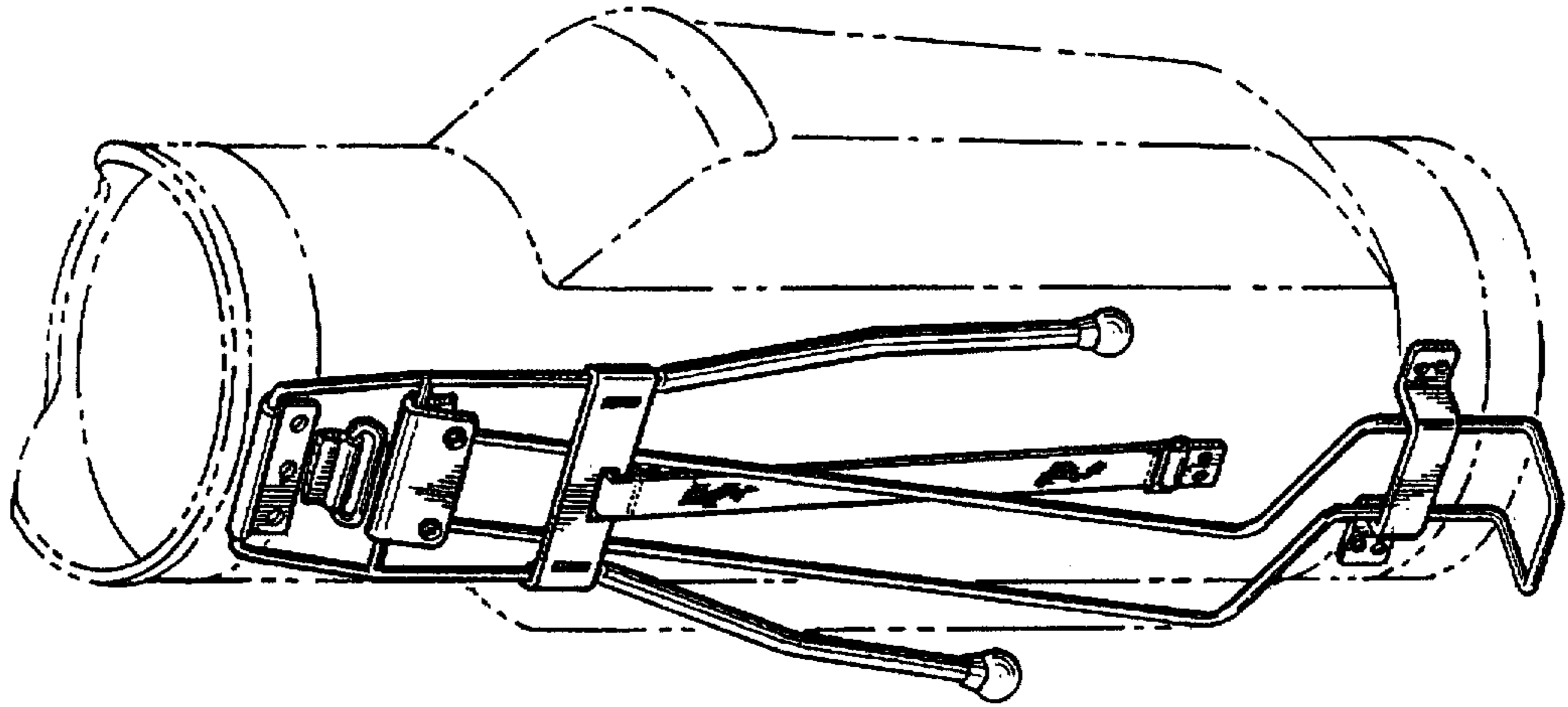

FIG. 9

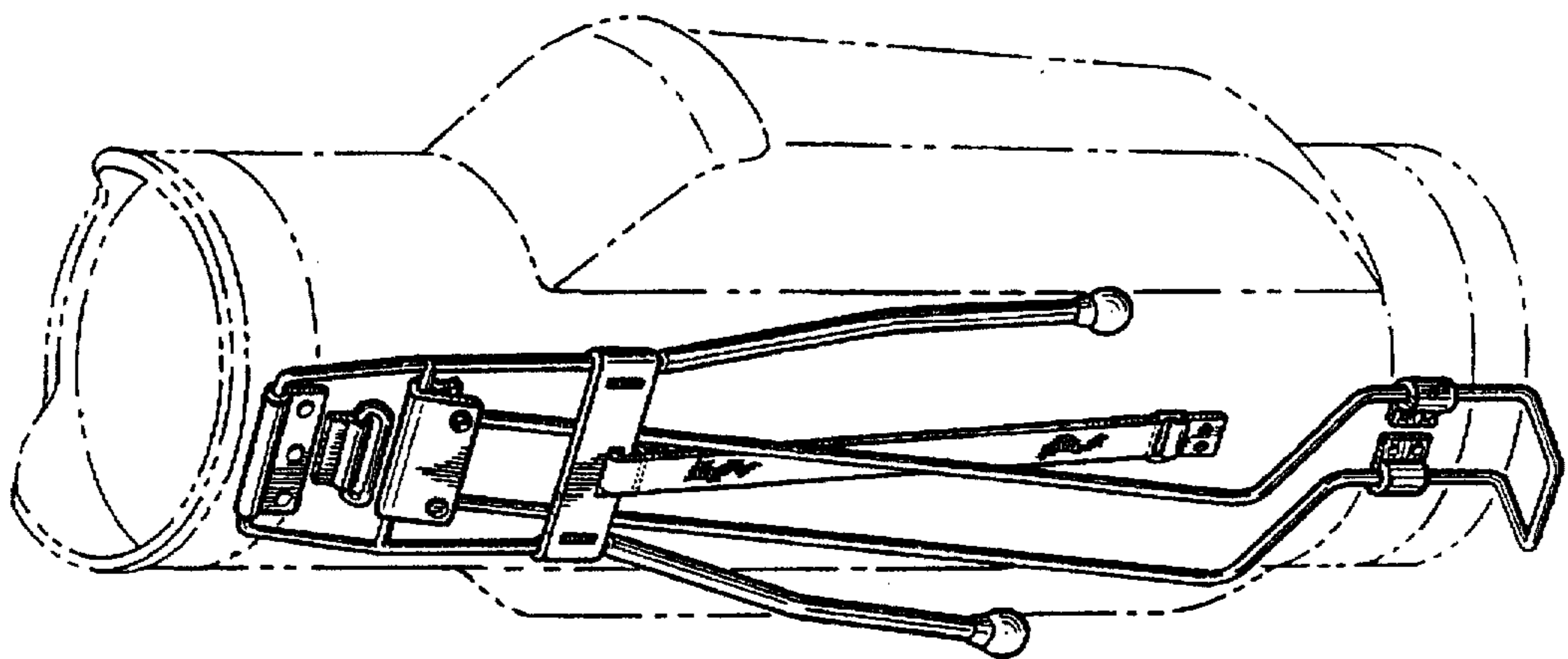

FIG. II

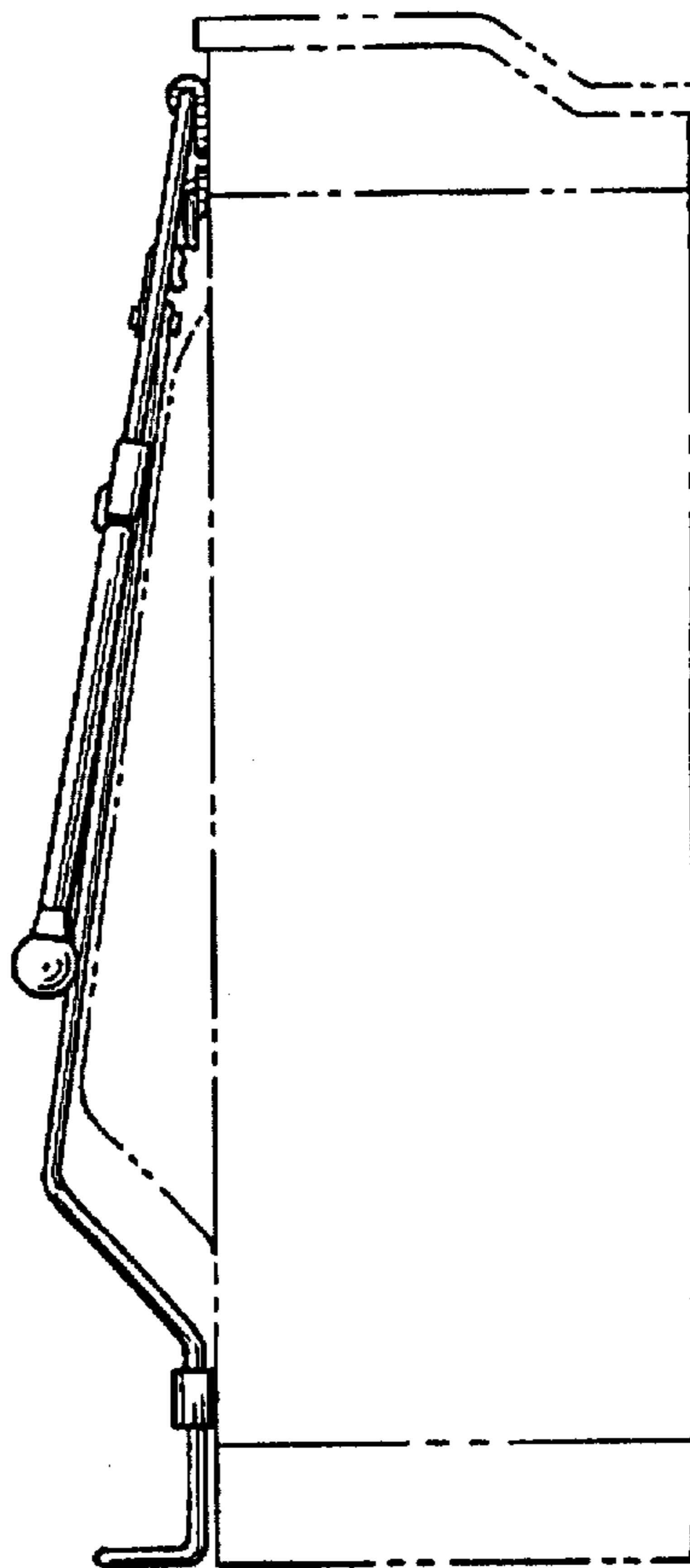

FIG. 12

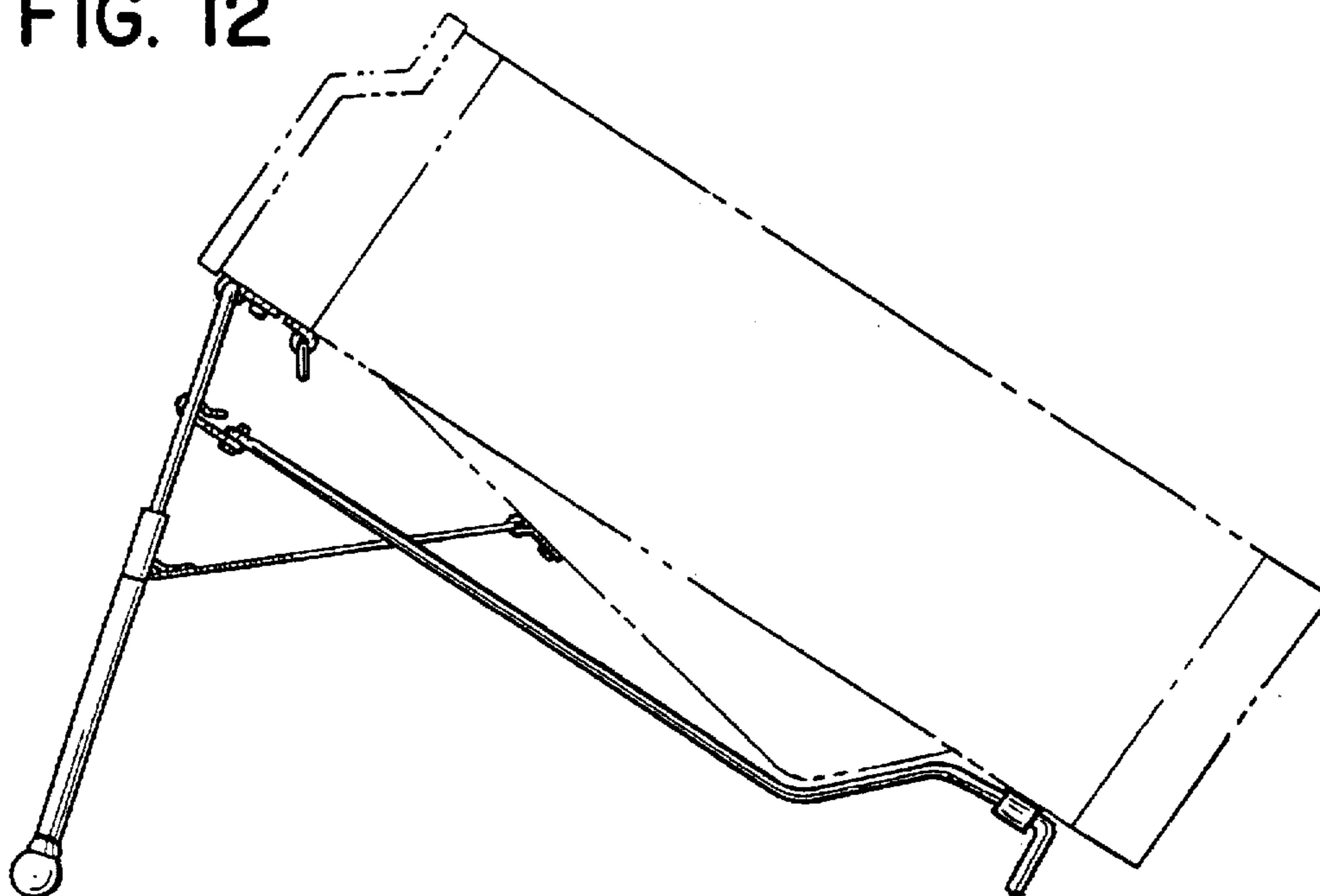

FIG. 13

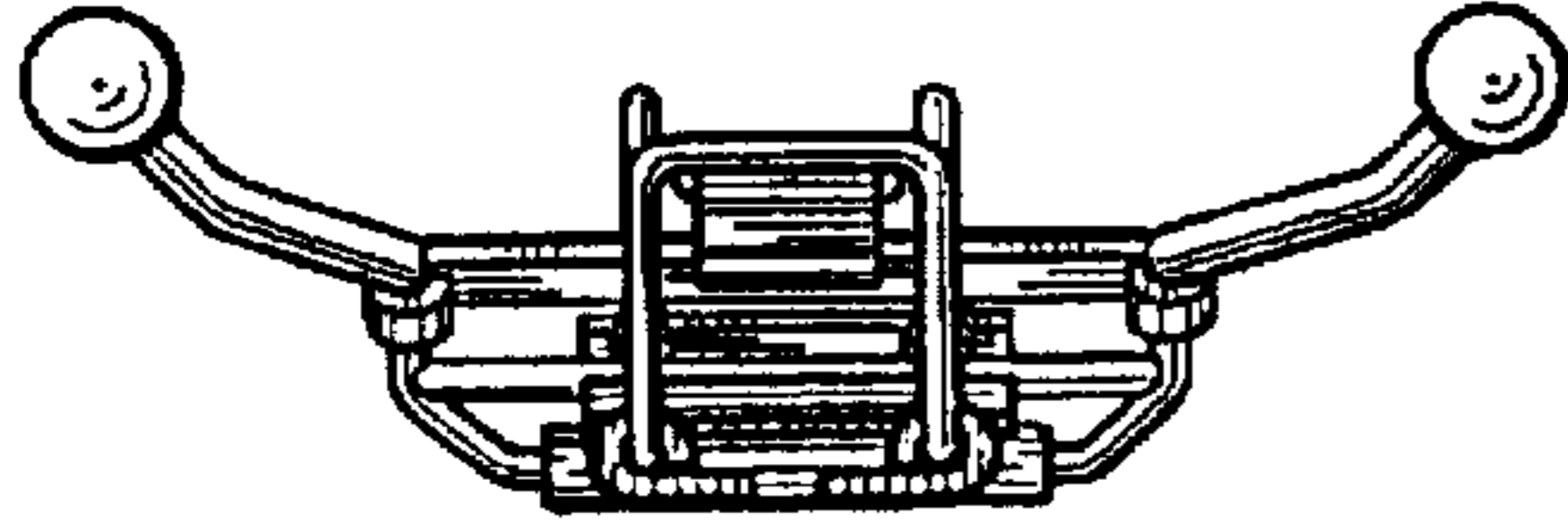

FIG. 14

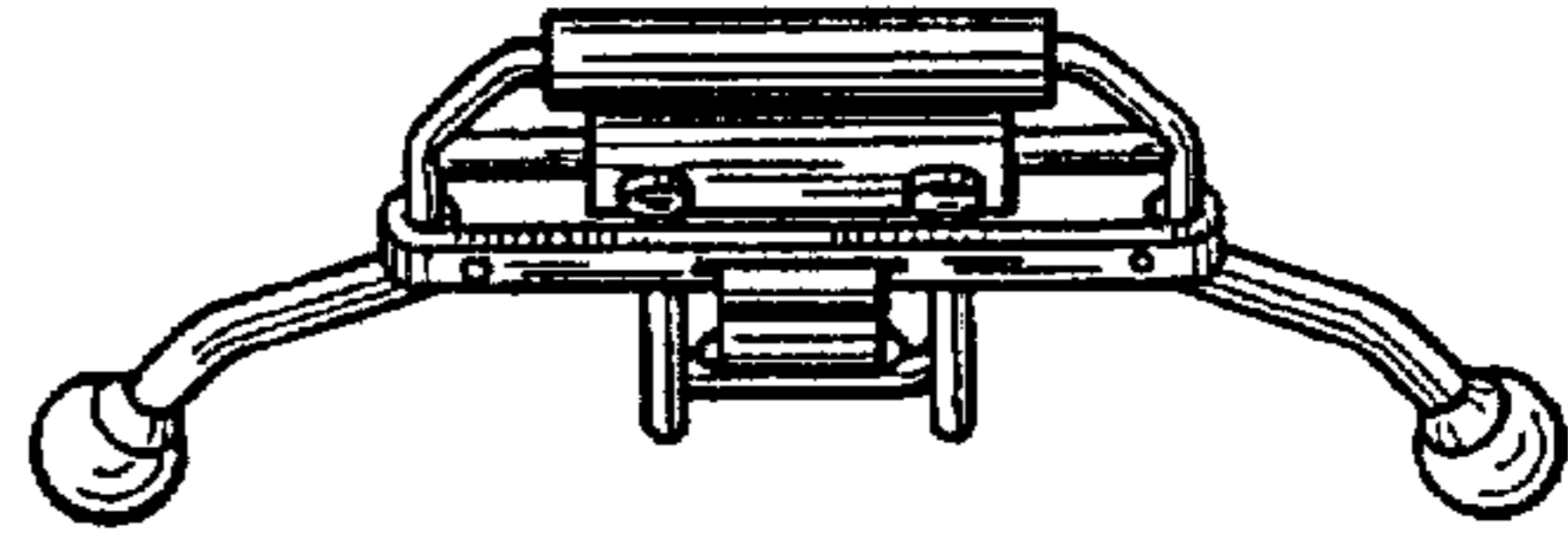

FIG. 15

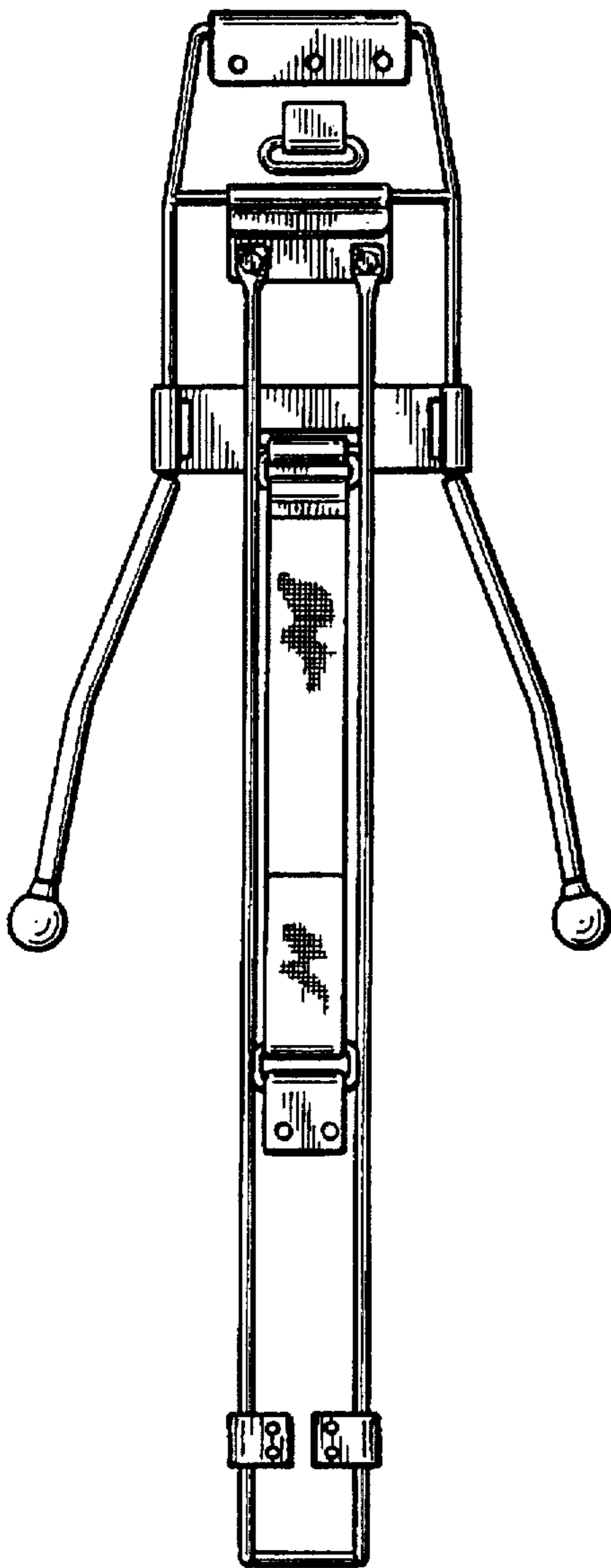

FIG. 16

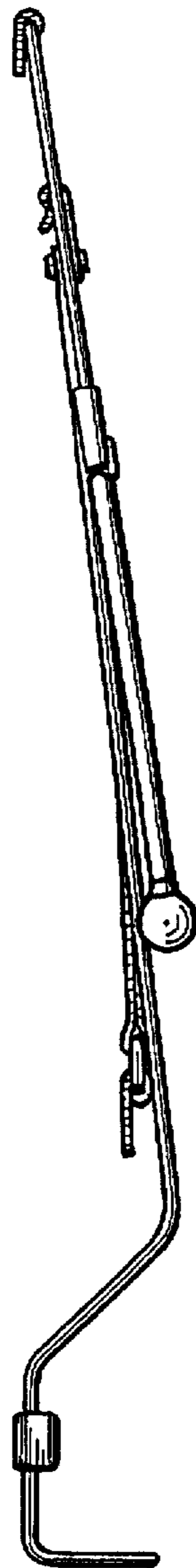

FIG. 17

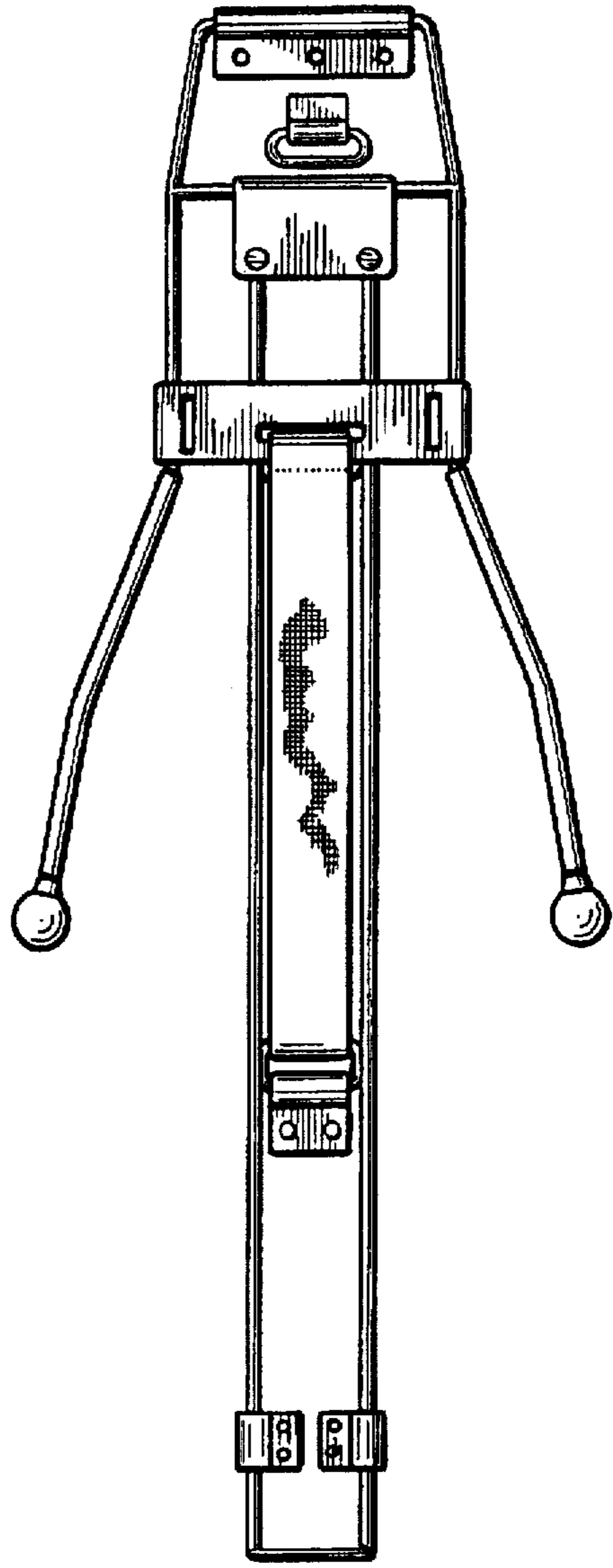

FIG. 18

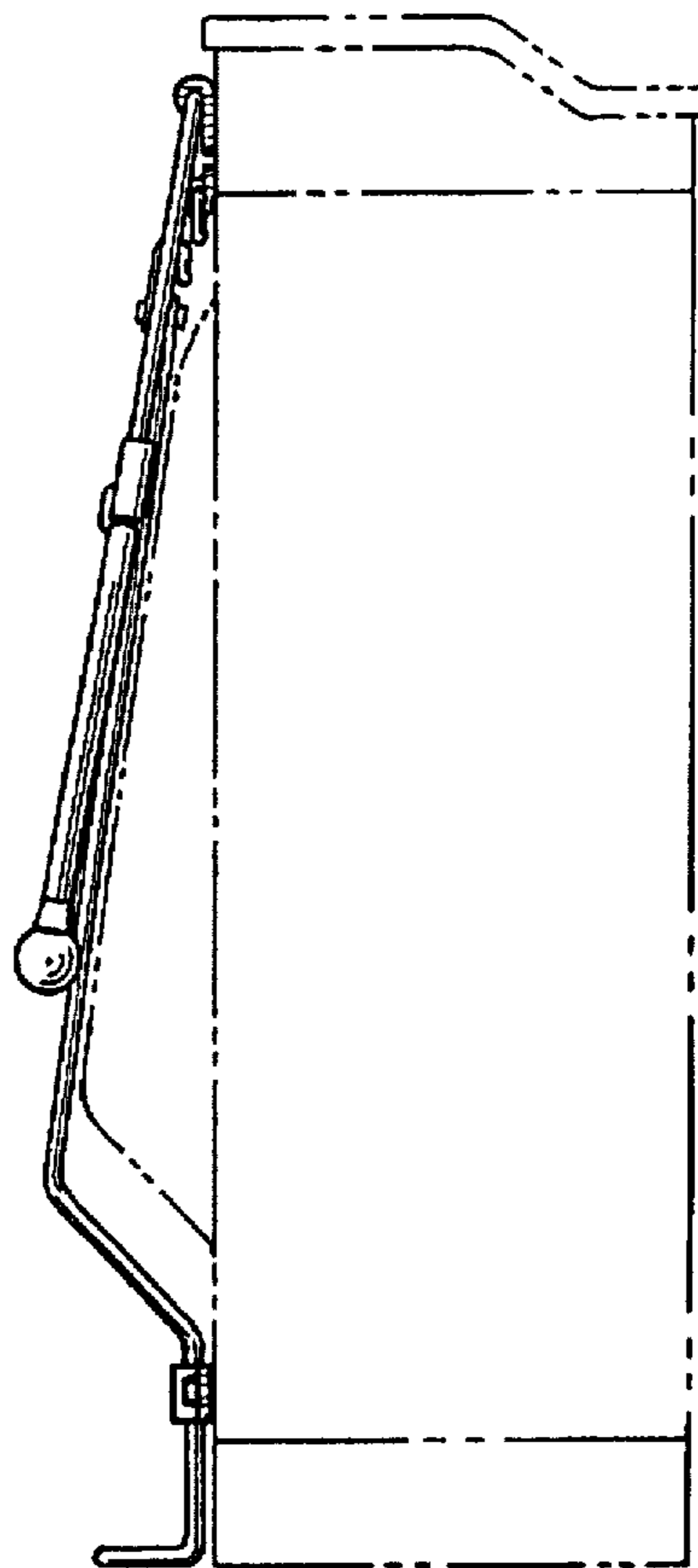

FIG. 19

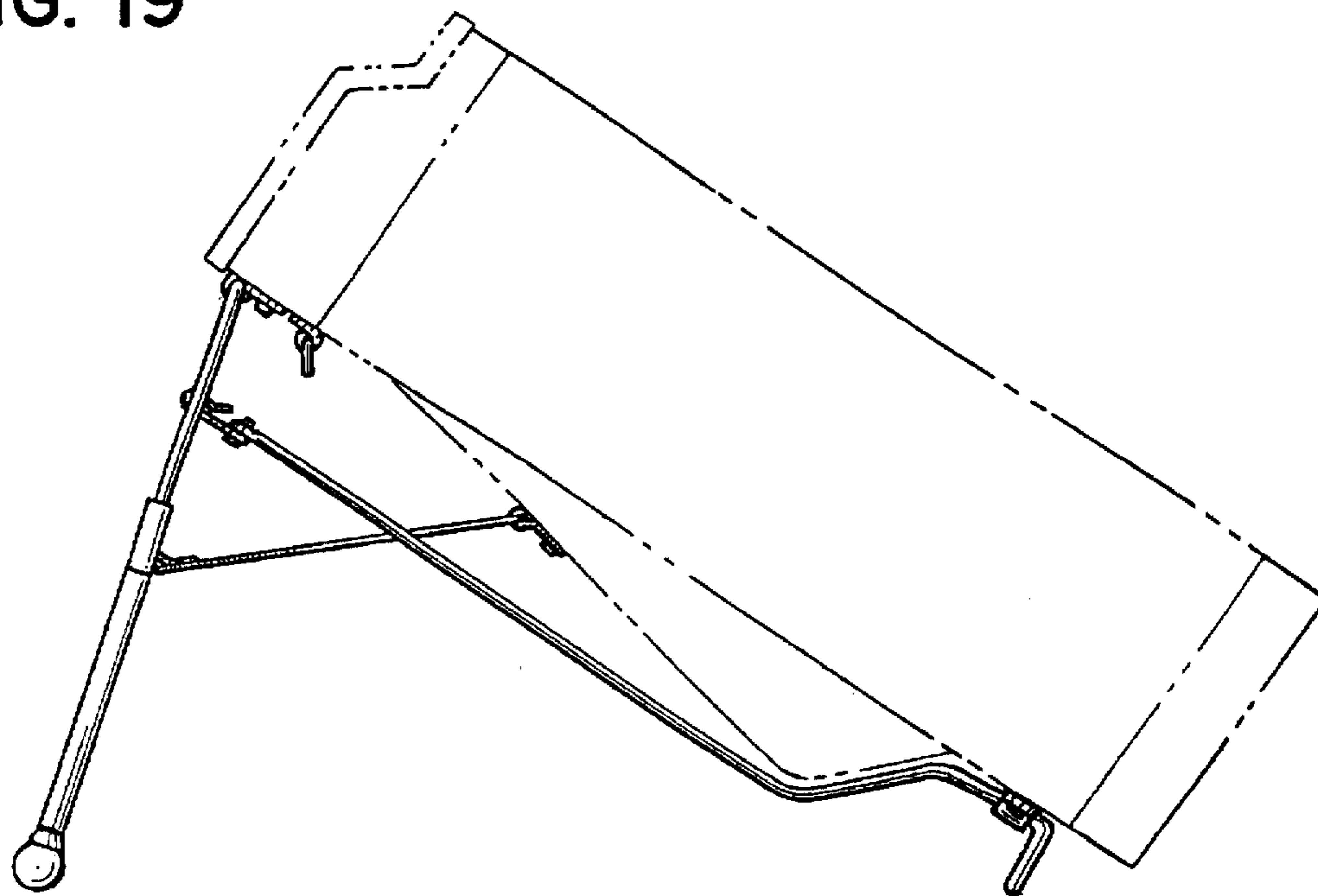

FIG. 20

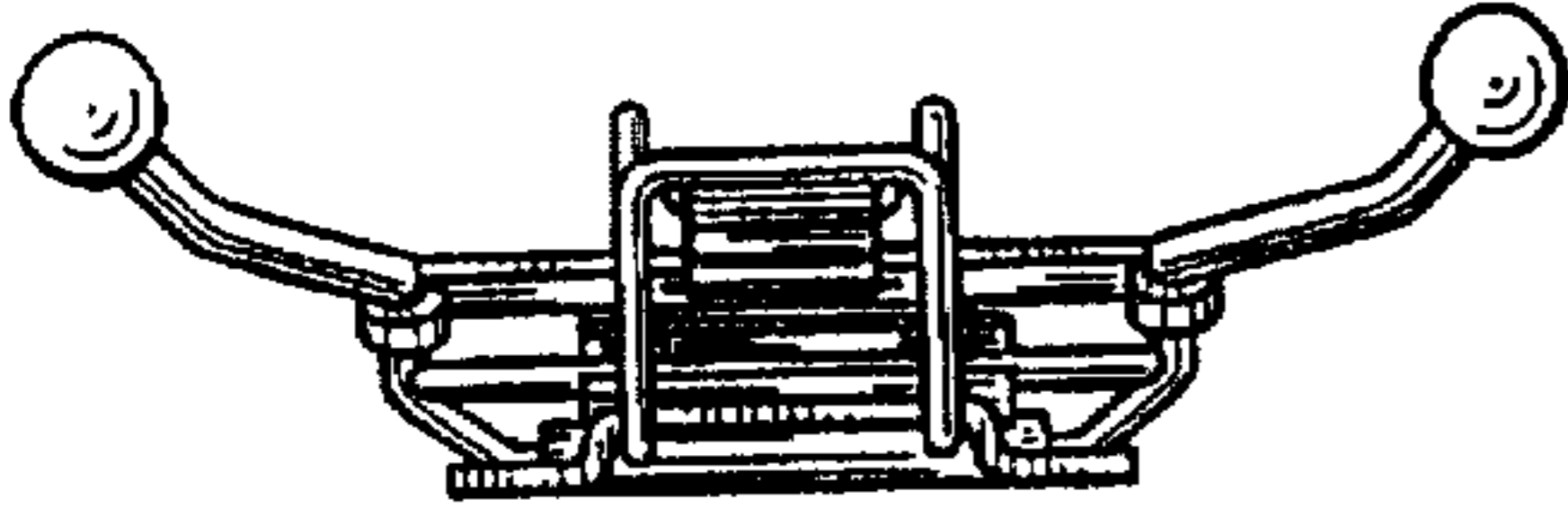

FIG. 21

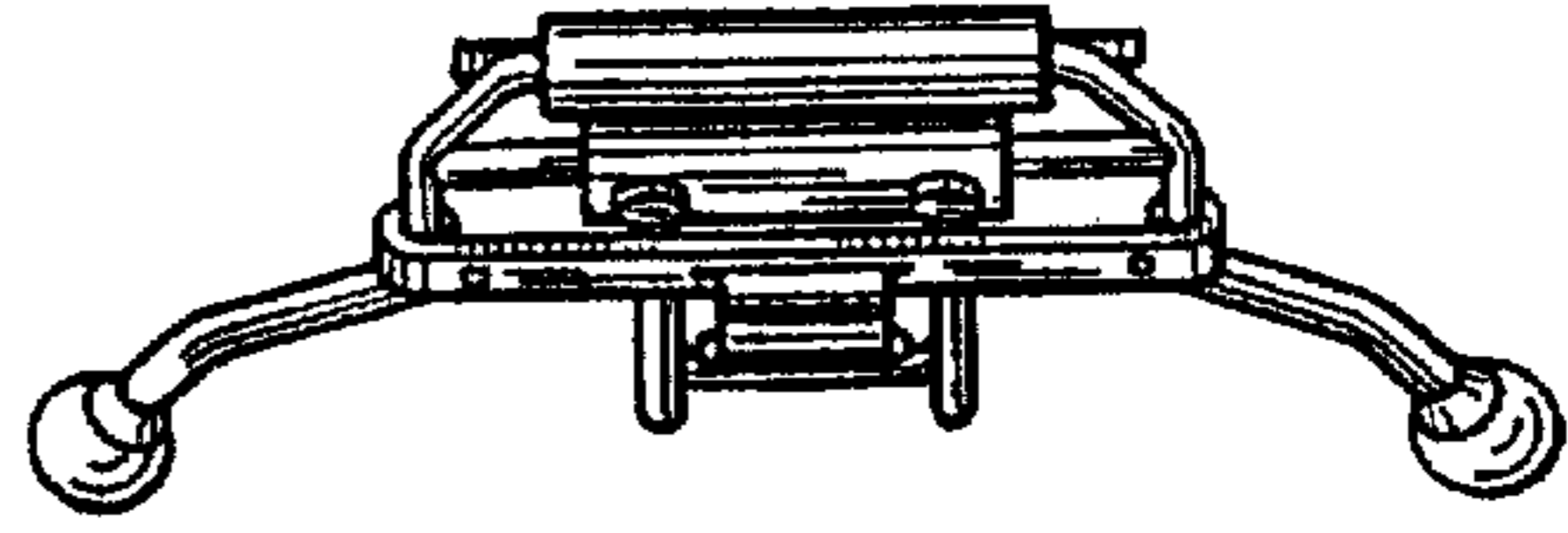

FIG. 22

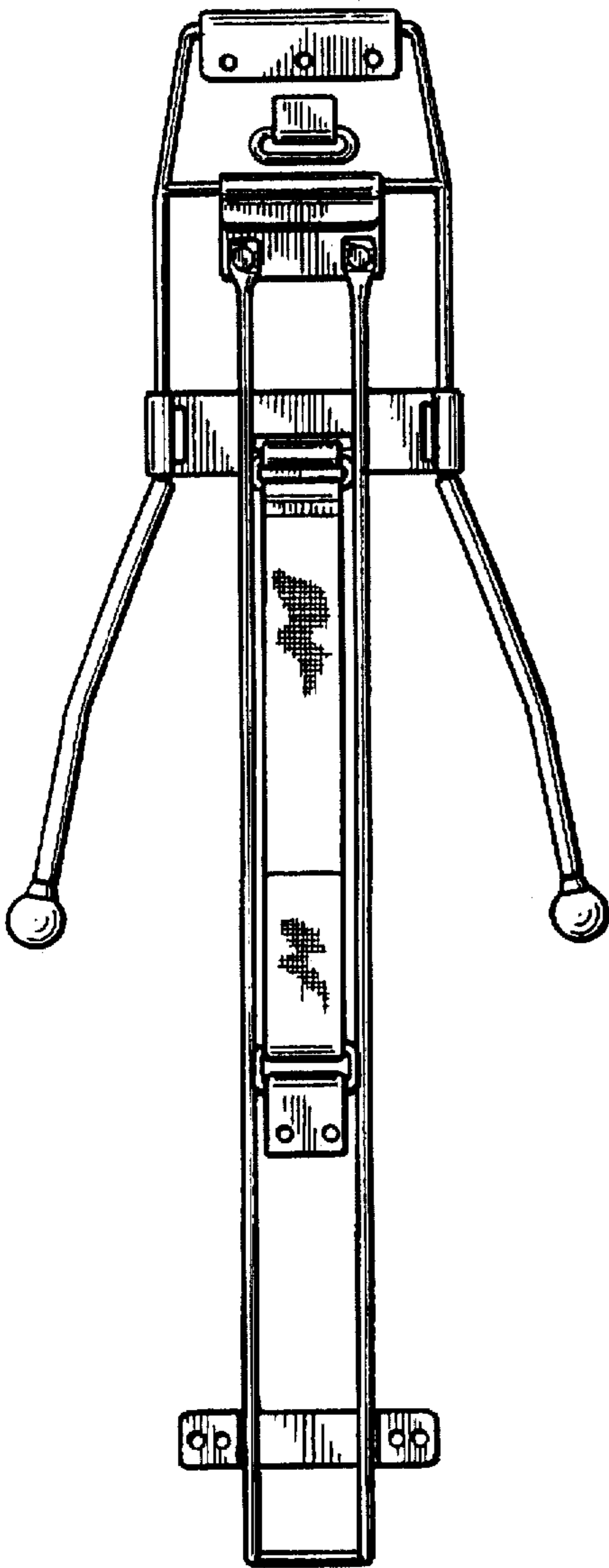

FIG. 23



FIG. 24

