



US00D383850S

United States Patent [19]
Machuron

[11] **Patent Number: Des. 383,850**

[45] **Date of Patent: **Sep. 16, 1997**

[54] **APPARATUS FOR REMOVING WRINKLES**

[75] **Inventor: Robert Machuron, Saint-Vallier, France**

[73] **Assignee: Ronic Industries, Nice, France**

[**] **Term: 14 Years**

[21] **Appl. No.: 56,436**

[22] **Filed: Jun. 28, 1996**

[30] **Foreign Application Priority Data**

Feb. 20, 1996 [FR] France 96 1091

[51] **LOC (6) Cl. 28-03**

[52] **U.S. Cl. D24/215; D32/70**

[58] **Field of Search D32/17, 68, 70; D24/200, 206, 214, 215; 38/74, 88; 219/245, 227, 228; 223/51; 601/15; 607/96, 108-111**

[56] **References Cited**

U.S. PATENT DOCUMENTS

- D. 143,884 2/1946 Snyder D32/70
- D. 157,605 3/1950 Krause D32/68 X
- D. 288,848 3/1987 Kaeser D24/214
- D. 301,074 5/1989 Terrailon D32/70
- D. 340,330 10/1993 Seguljic D32/70
- D. 360,509 7/1995 Maeda et al. D32/70
- 4,705,030 11/1987 Tepperberg D24/214 X

Primary Examiner—James Gandy
Assistant Examiner—Cathron B. Matta
Attorney, Agent, or Firm—Laubscher & Laubscher

[57] **CLAIM**

The ornamental design for an apparatus for removing wrinkles, as shown and described.

DESCRIPTION

FIG. 1 is a right elevational view of the apparatus for removing wrinkles;

FIG. 2 is a front elevational view of the apparatus for removing wrinkles;

FIG. 3 is a top plan view of the apparatus for removing wrinkles;

FIG. 4 is a rear elevational view of the apparatus for removing wrinkles;

FIG. 5 is a left side elevational view of the apparatus for removing wrinkles;

FIG. 6 is a bottom plan view of the apparatus for removing wrinkles; and,

FIG. 7 is a perspective view of the apparatus for removing wrinkles.

The broken line showing of a cord and electrical adapter box is for illustrative purposes only and forms no part of the claimed design.

1 Claim, 4 Drawing Sheets

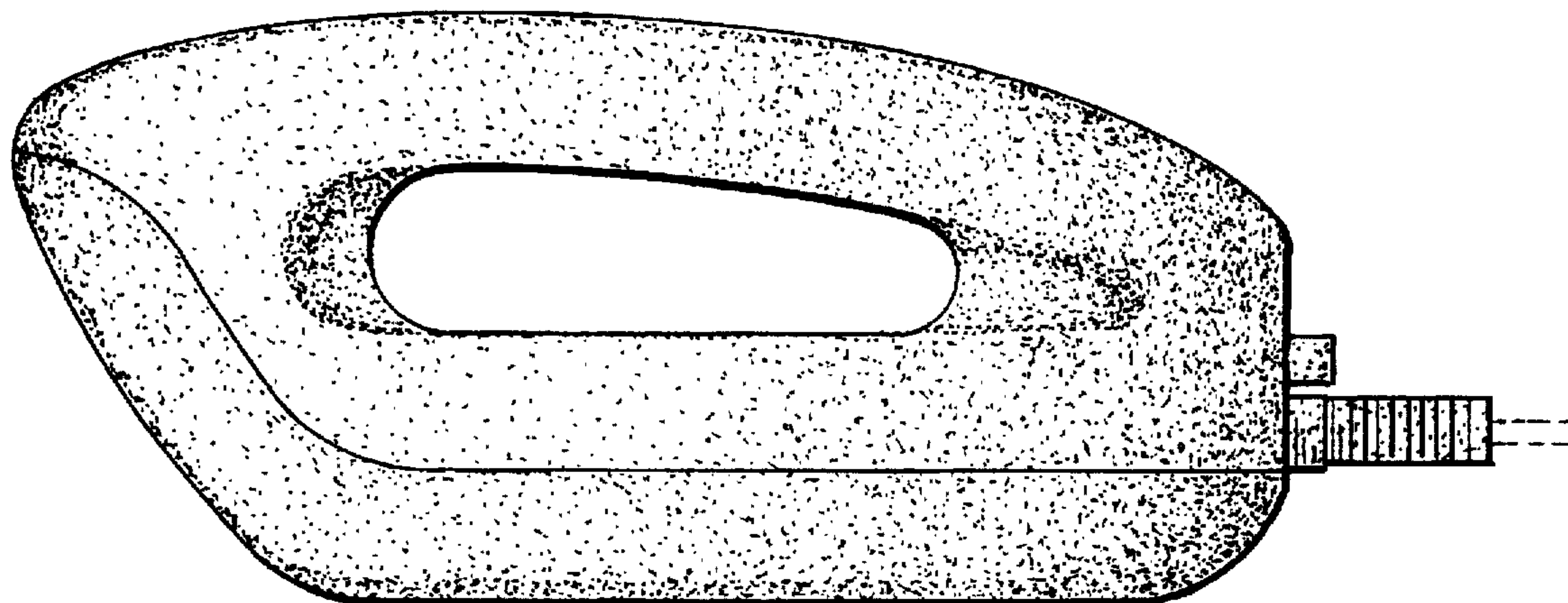

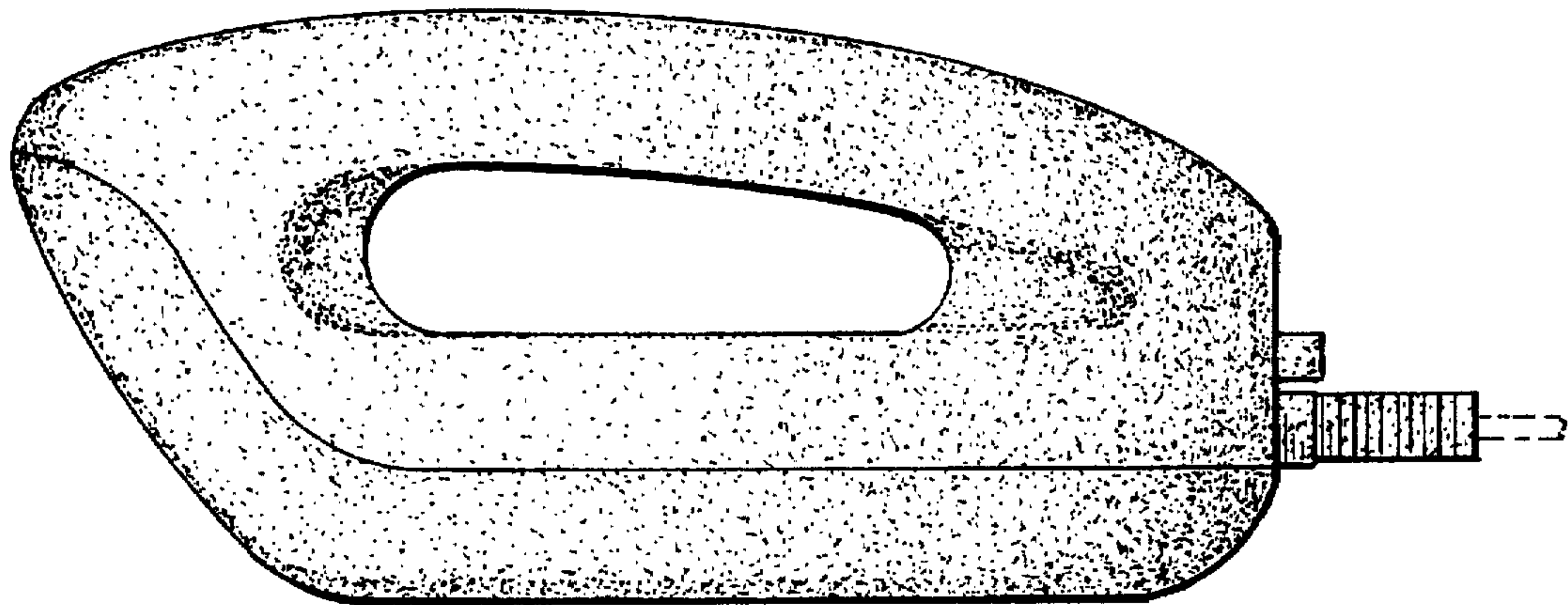

FIG. 1

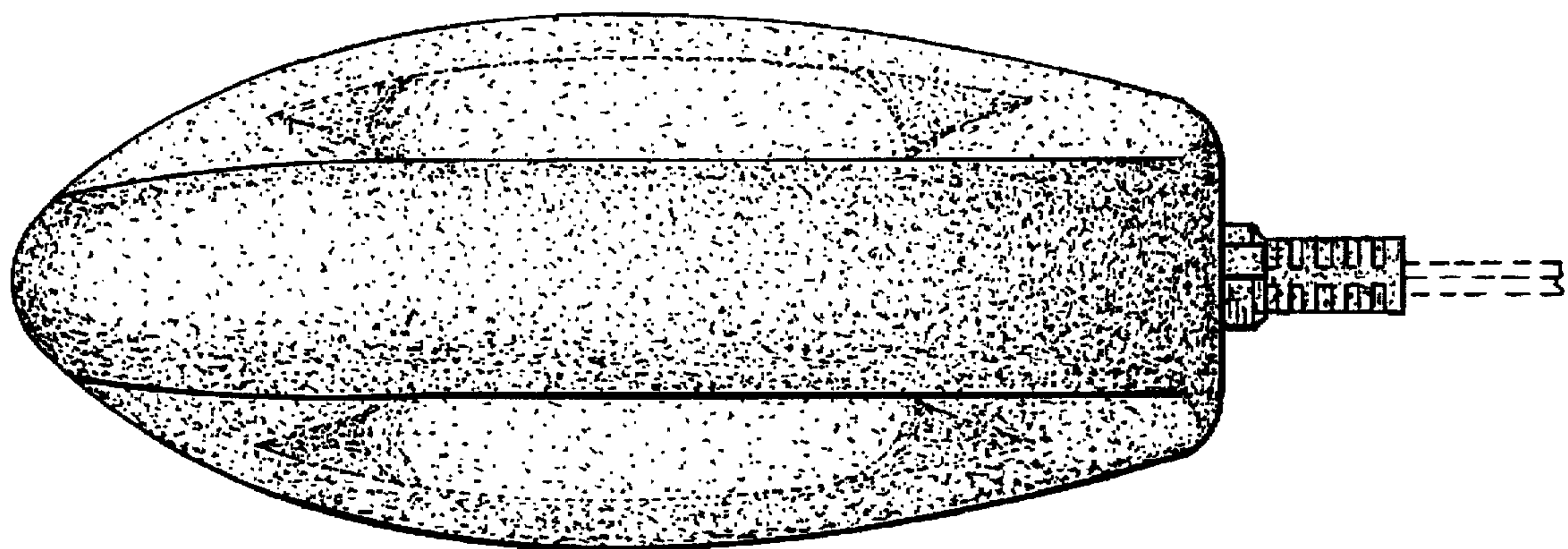

FIG. 3

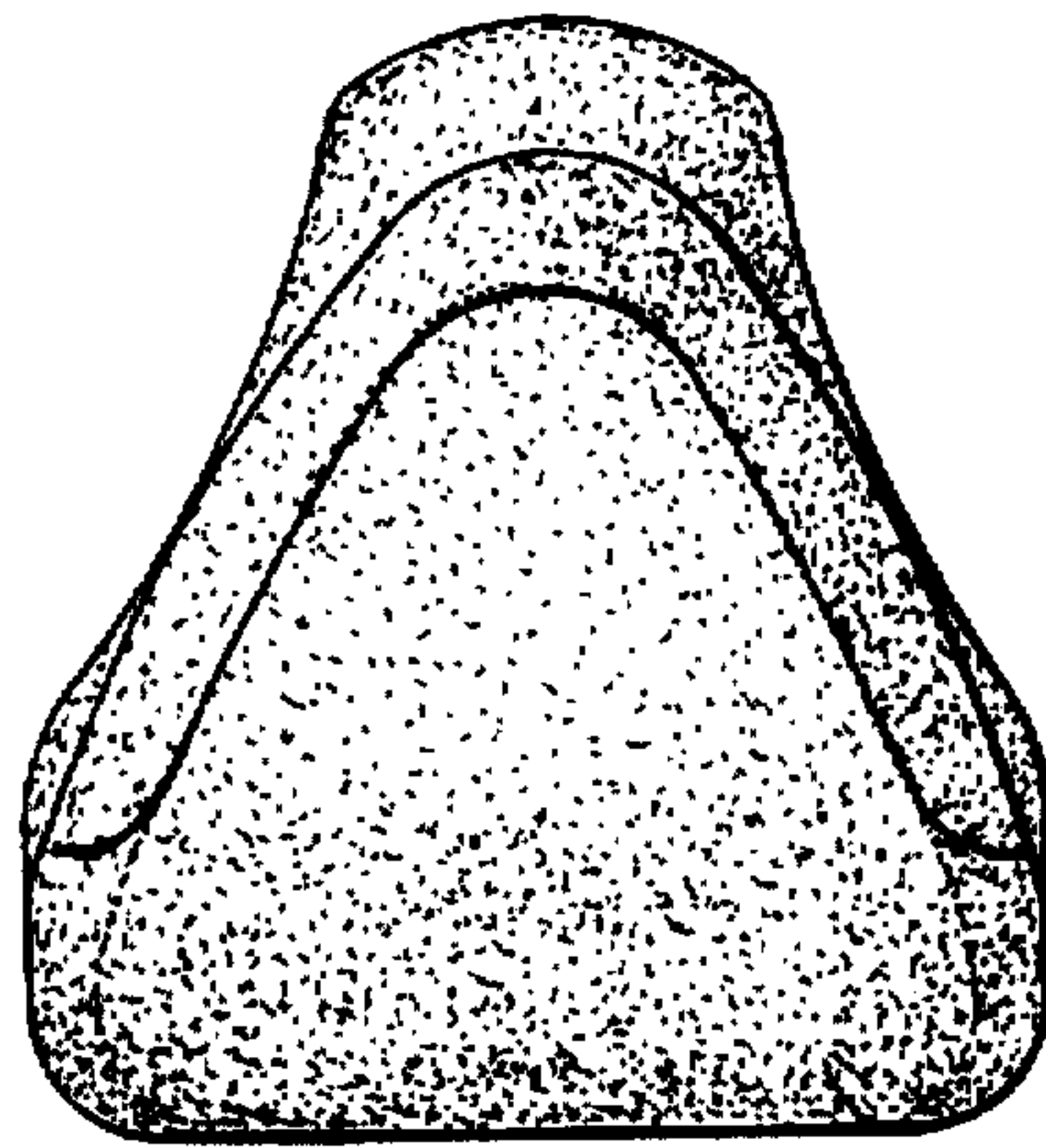

FIG. 2

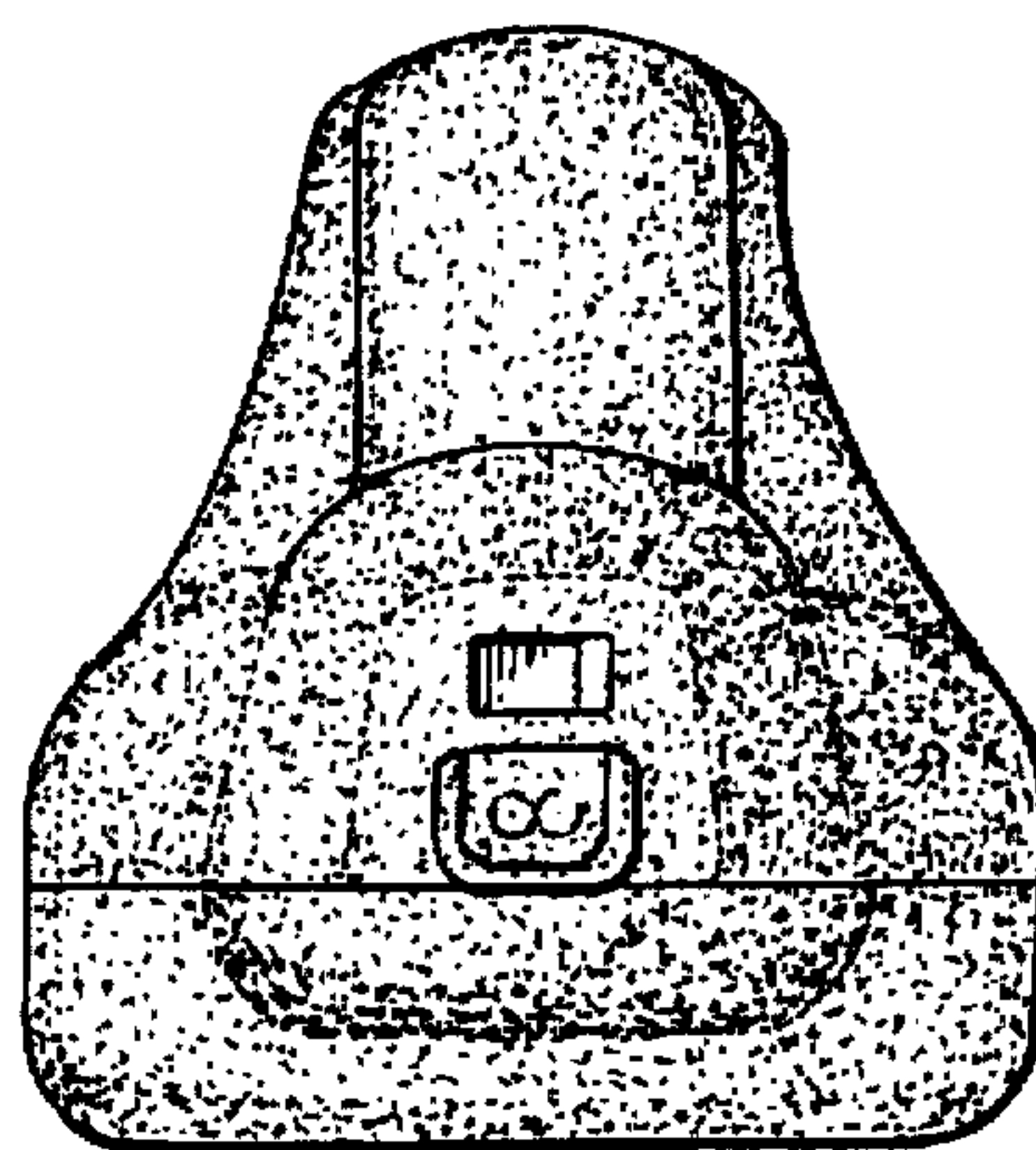

FIG. 4

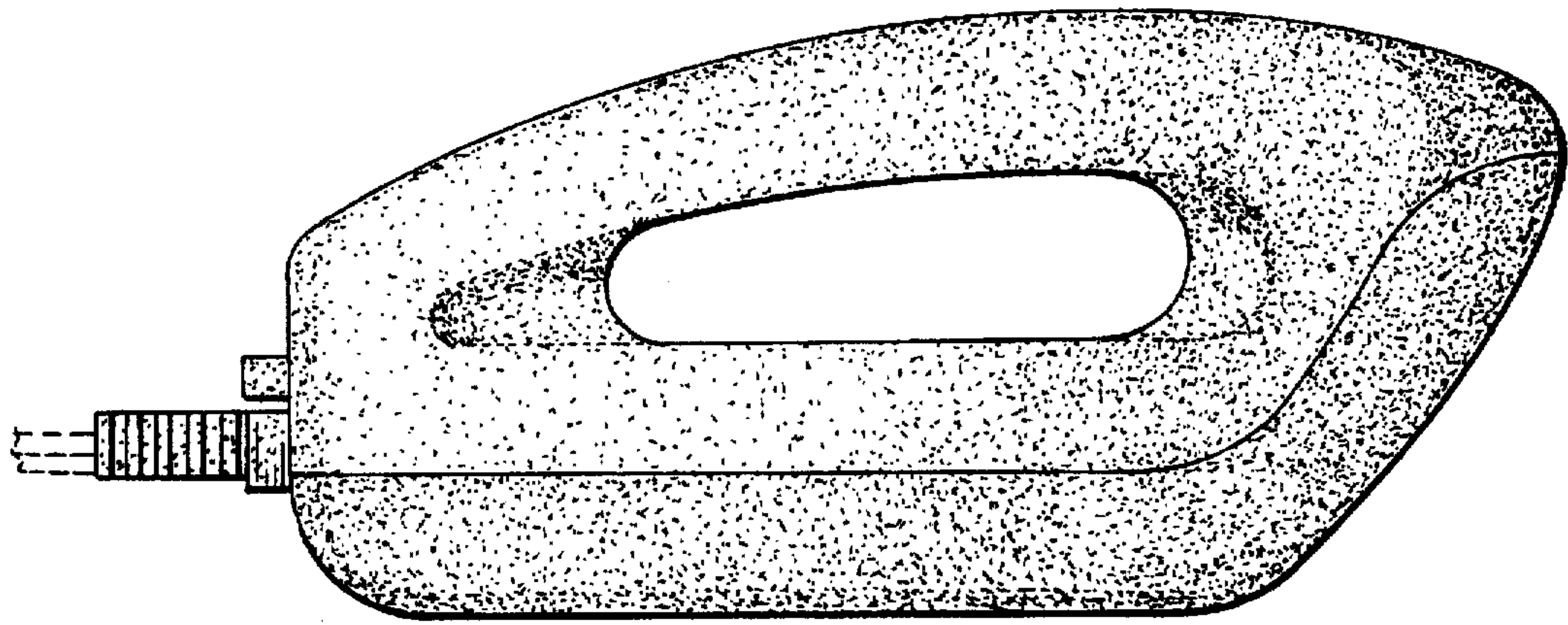

FIG. 5

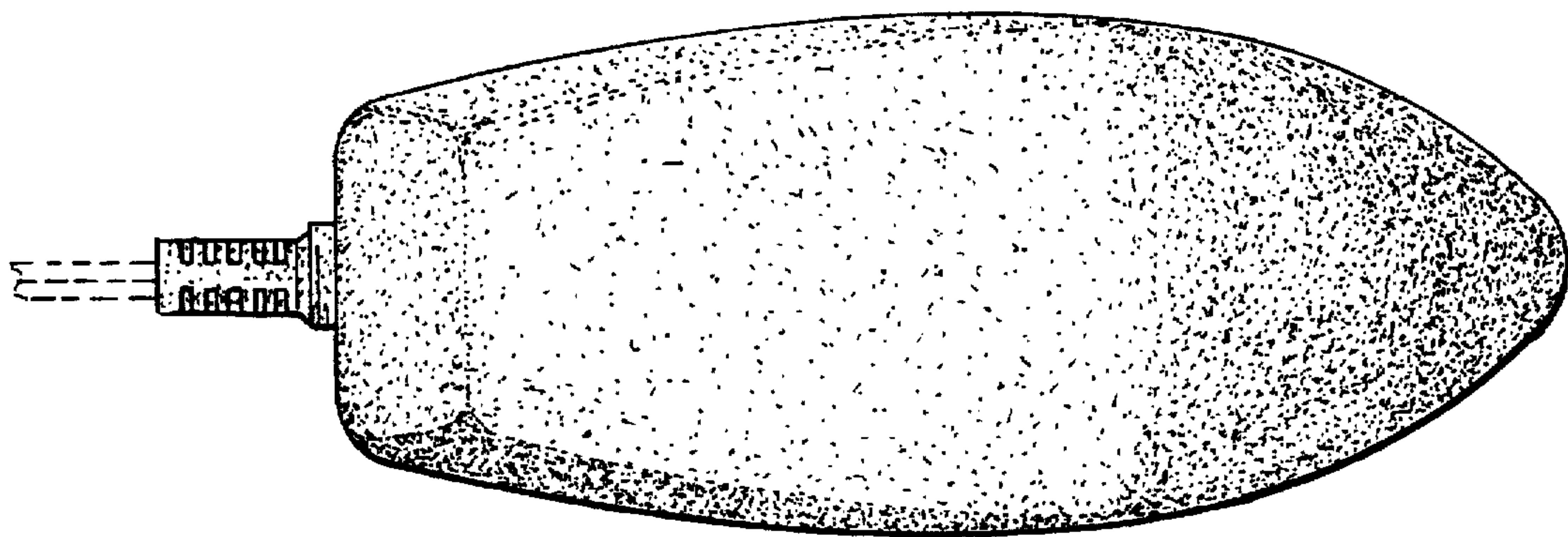

FIG. 6

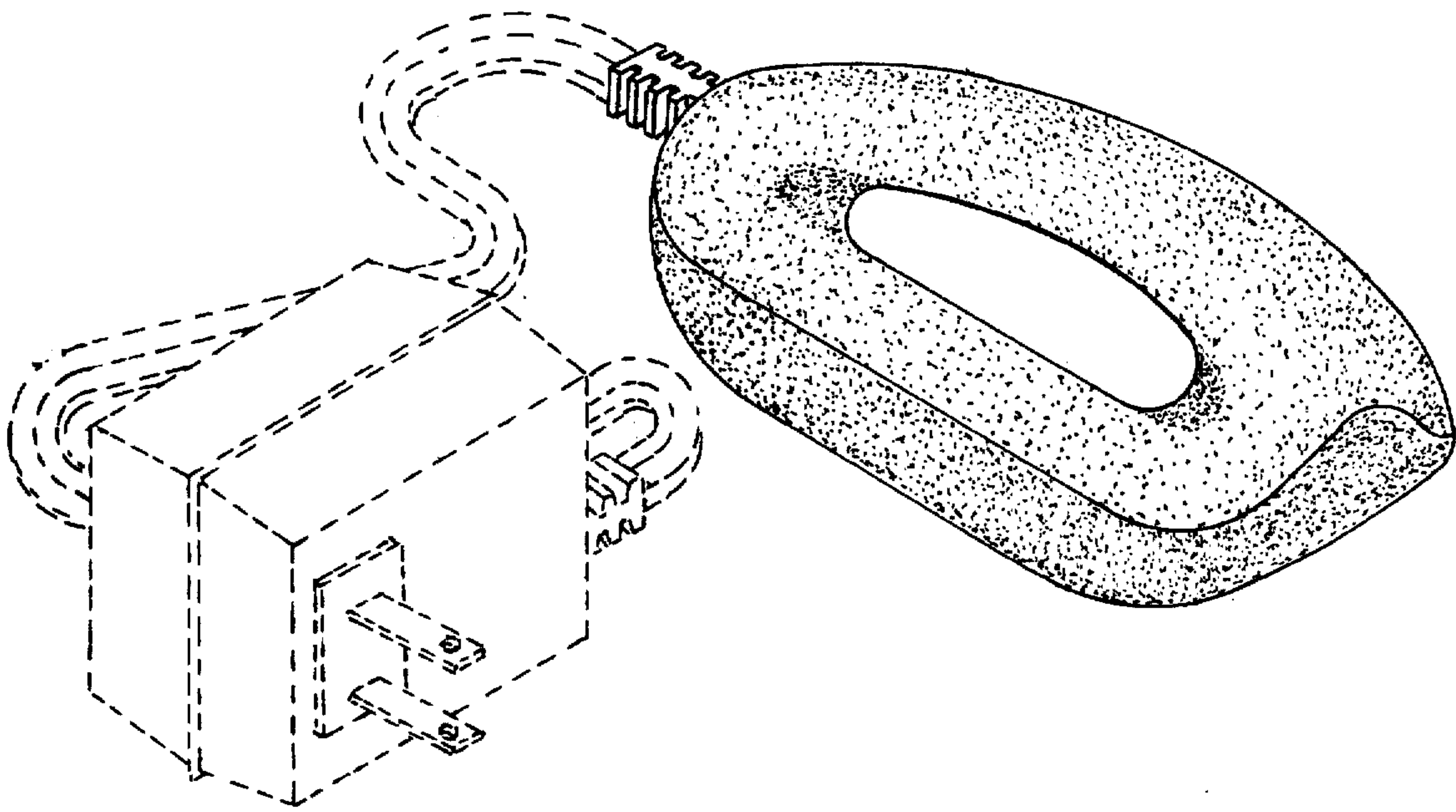

FIG. 7