



US00D383813S

United States Patent [19]

[11] Patent Number: **Des. 383,813**

Zoller

[45] Date of Patent: ****Sep. 16, 1997**

[54] **FOOT EXERCISE DEVICE**

4,422,635	12/1983	Herod et al.	482/80
5,069,445	12/1991	Mai	482/80
5,125,647	6/1992	Smith	482/80
5,186,700	2/1993	Wang	482/80

[76] Inventor: **Robert G. Zoller**, 4693 Slade Dr.,
Fairfield, Ohio 45014

[**] Term: **14 Years**

Primary Examiner—Philip S. Hyder
Attorney, Agent, or Firm—Harold H. Dutton, Jr.; Diane F. Liebman

[21] Appl. No.: **50,460**

[22] Filed: **Feb. 20, 1996**

[57] CLAIM

[51] LOC (6) Cl. **21-02**

The ornamental design for a foot exercise device, as shown.

[52] U.S. Cl. **D21/193; D21/191**

DESCRIPTION

[58] Field of Search D21/191, 192,
D21/193, 194, 195; 482/80, 128, 79, 51,
121, 123, 131

FIG. 1 is a perspective view of a foot exercise device showing my new design;

FIG. 2 is a right side view thereof;

FIG. 3 is a left side view thereof;

FIG. 4 is a front view thereof;

FIG. 5 is a rear view thereof;

FIG. 6 is a top view thereof; and,

FIG. 7 is a bottom view thereof.

[56] References Cited

U.S. PATENT DOCUMENTS

D. 251,313	3/1979	Jinotti	D21/194
D. 359,323	6/1995	Ross	D21/191
3,598,404	8/1971	Bowman	482/80
3,741,540	6/1973	Shimizu	482/128
4,111,416	9/1978	Jinotti	482/128

1 Claim, 4 Drawing Sheets

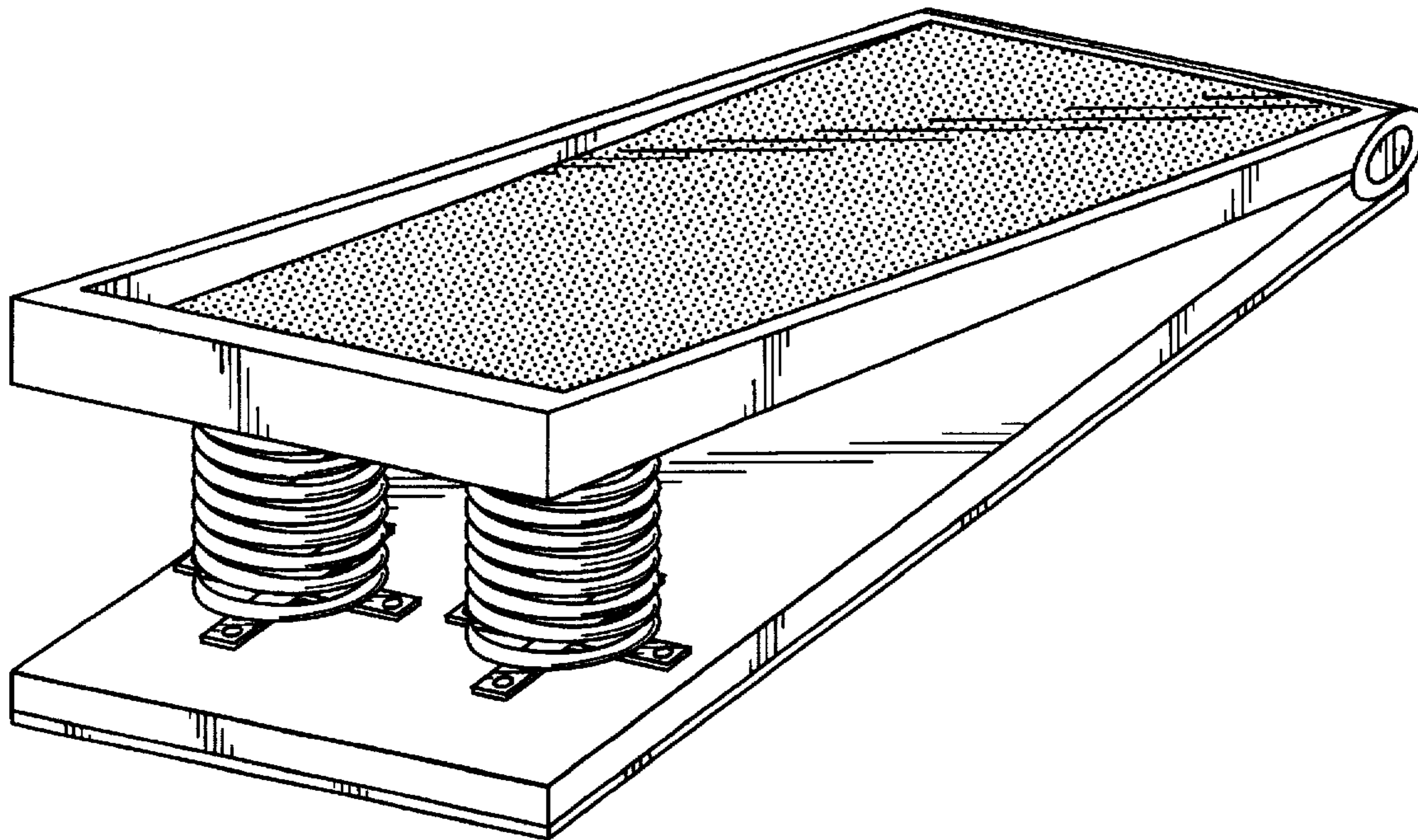

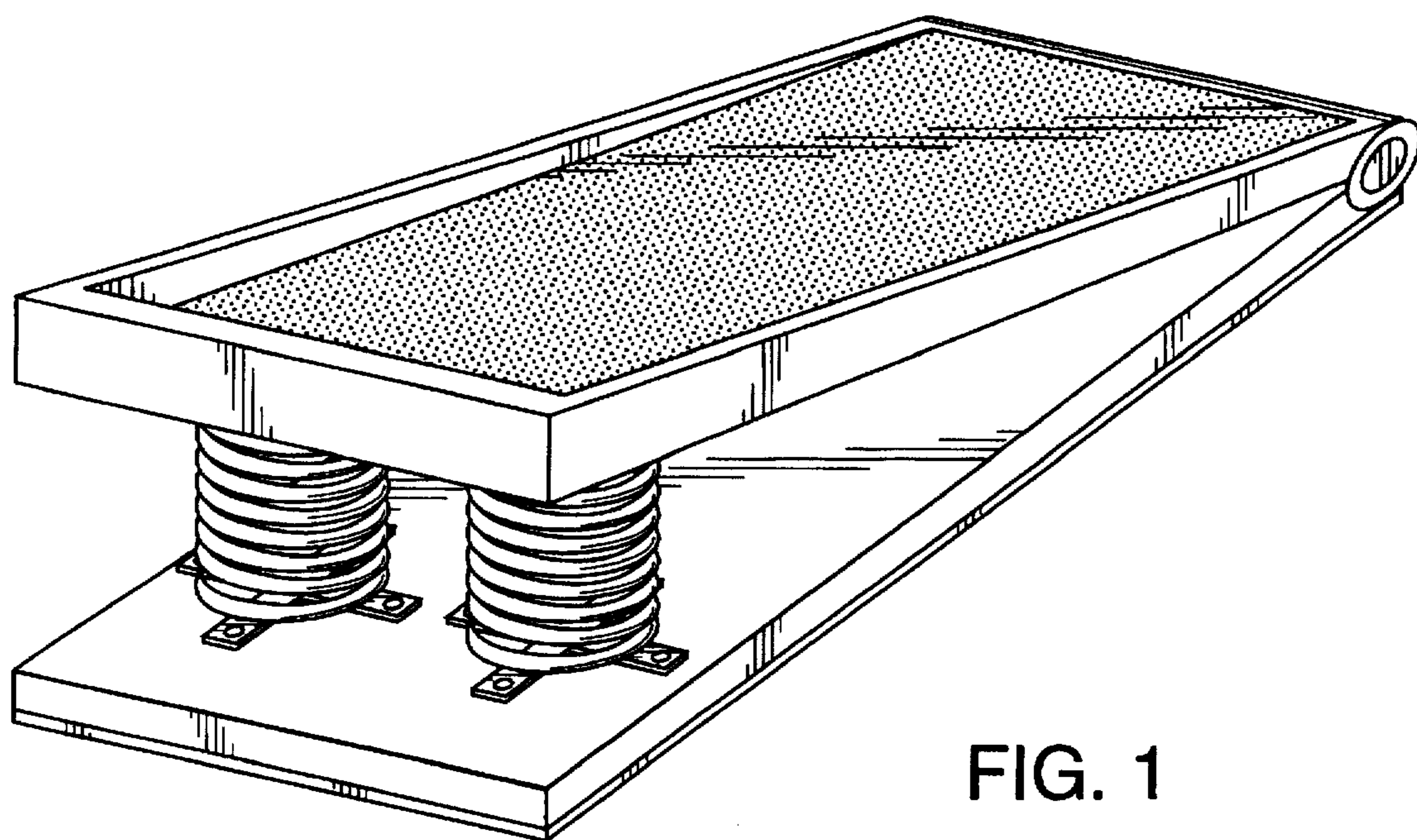

FIG. 1

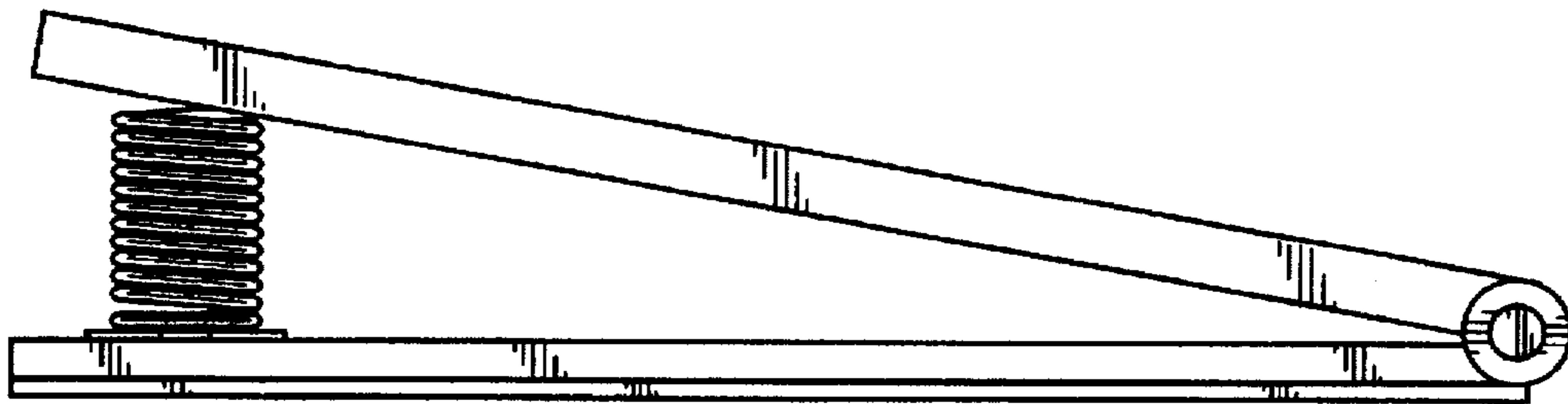

FIG. 2

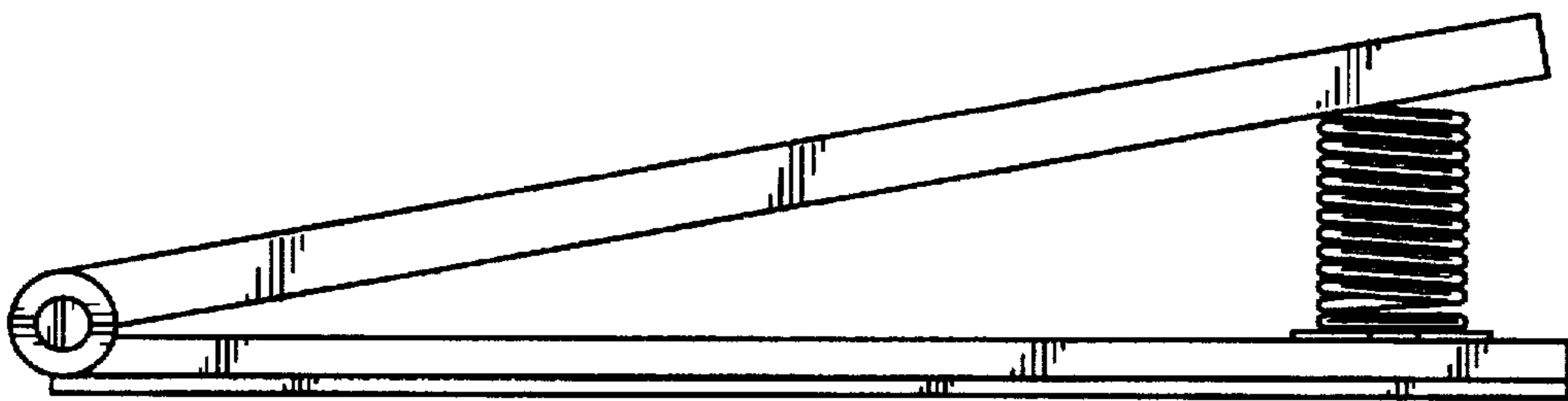

FIG. 3

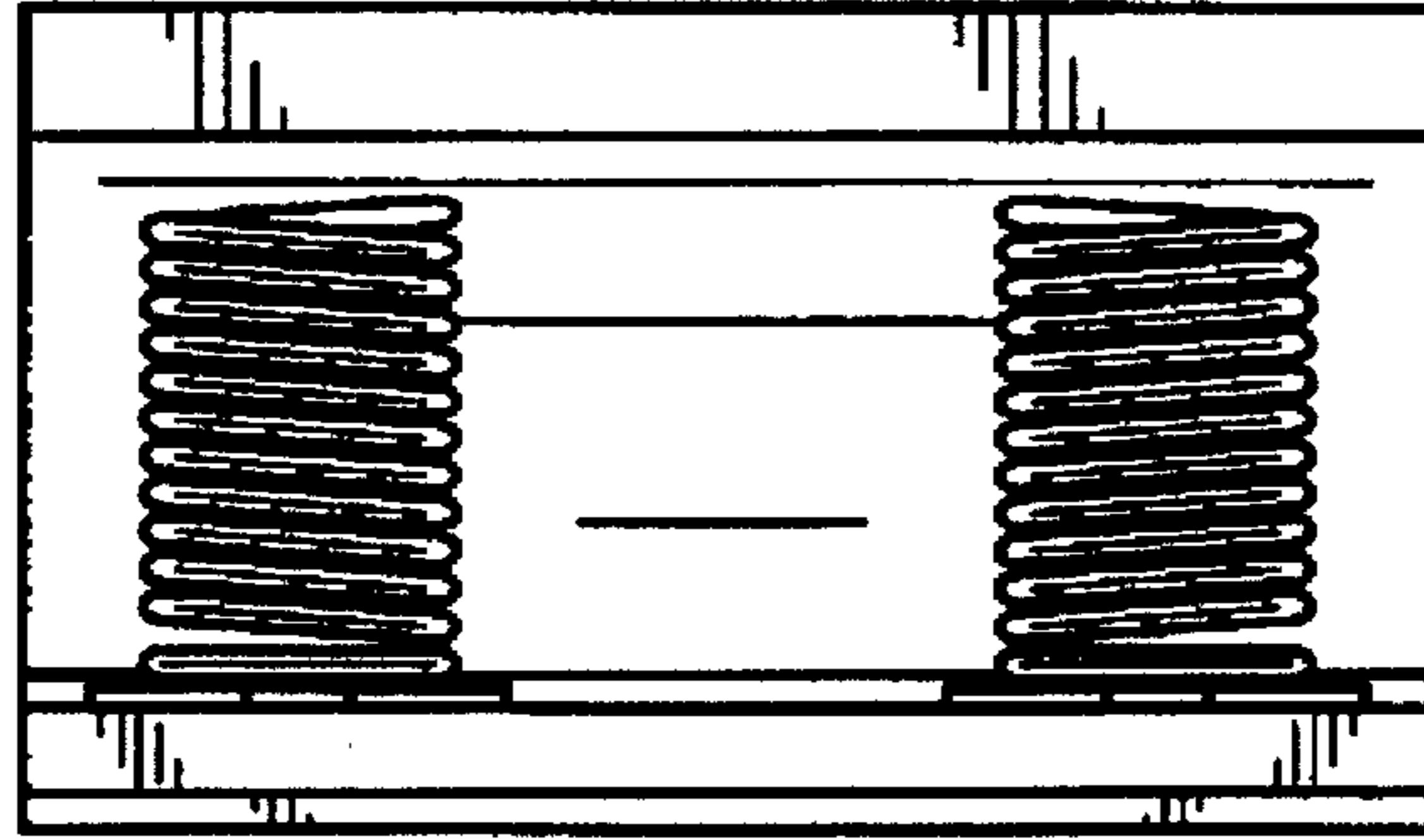

FIG. 4

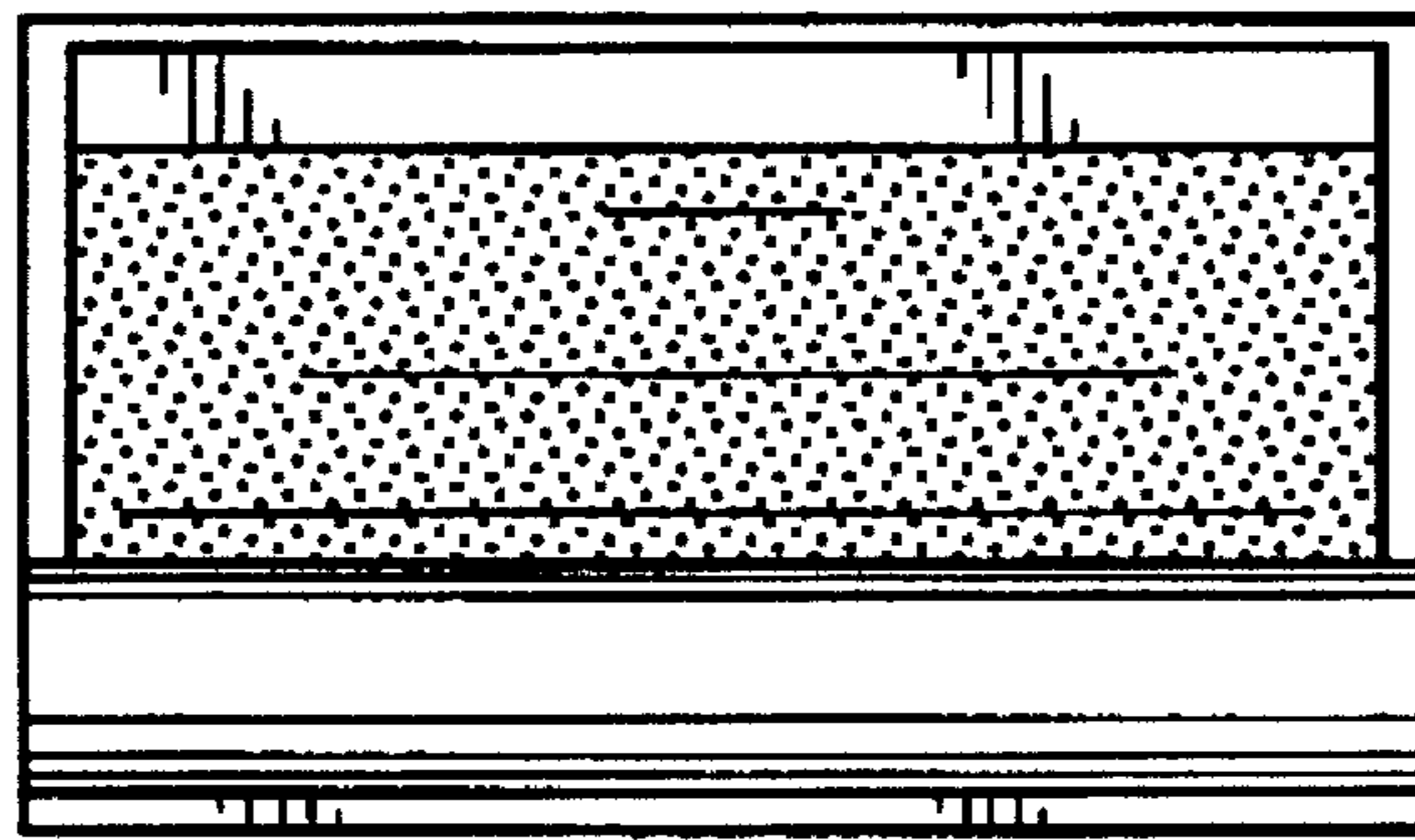

FIG. 5

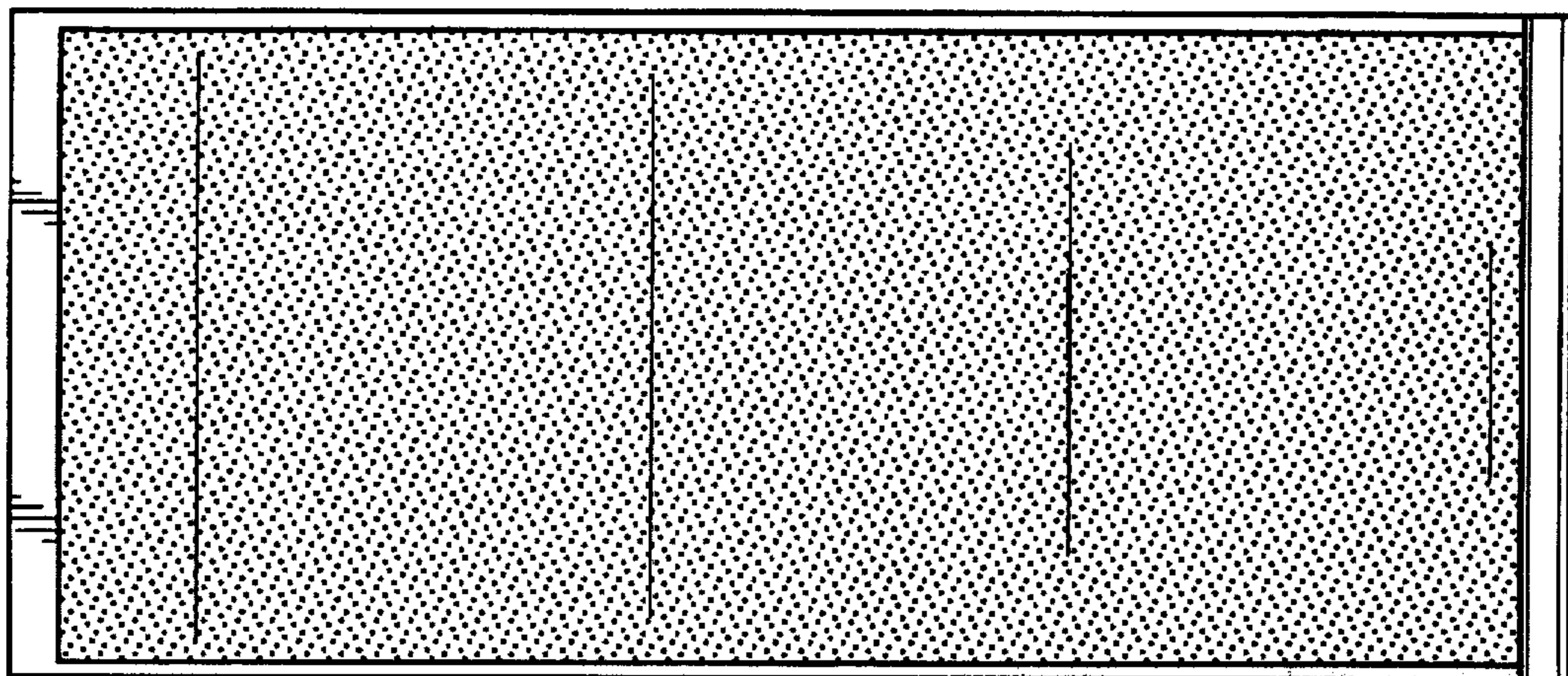

FIG. 6

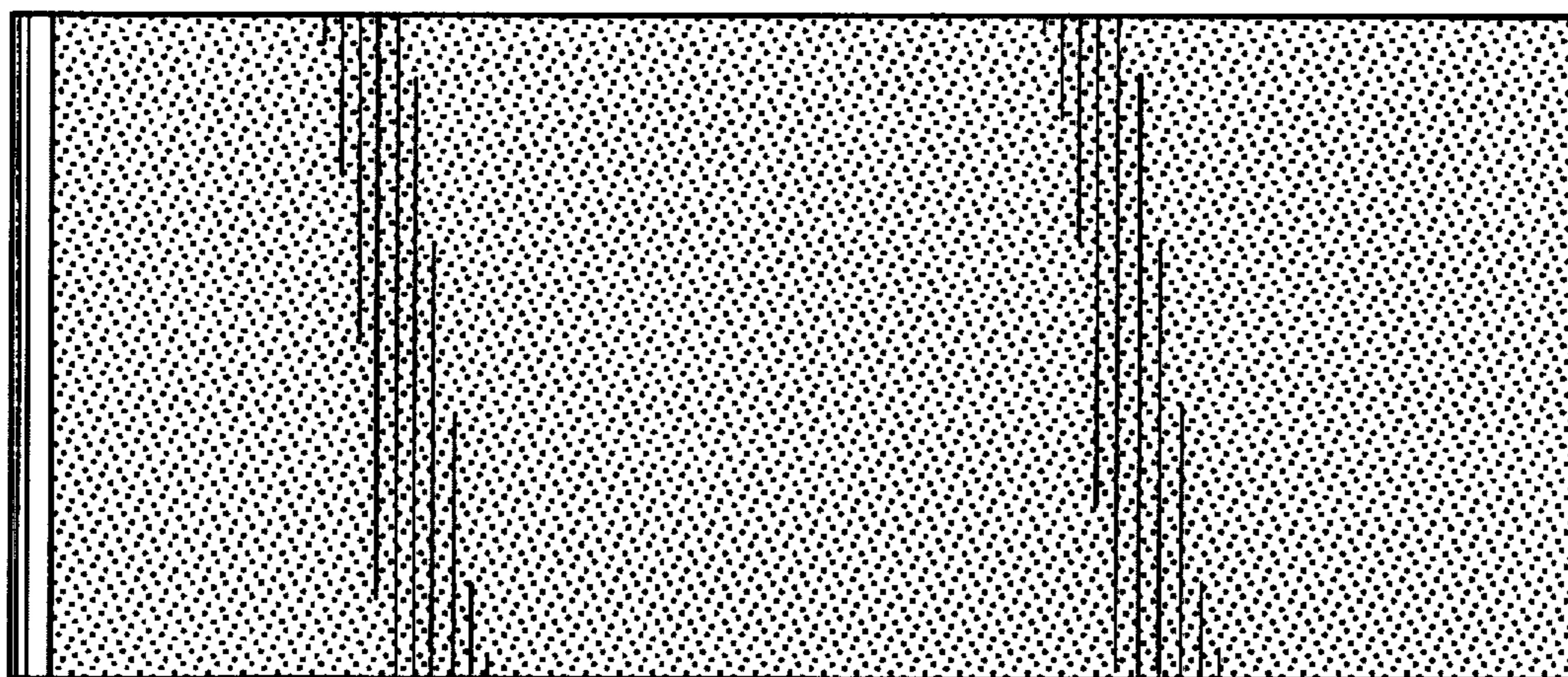

FIG. 7