



US00D383752S

**United States Patent** [19]  
**Matsuzaka**

[11] **Patent Number: Des. 383,752**  
[45] **Date of Patent: \*\*Sep. 16, 1997**

[54] **TAPE PLAYER**

[75] **Inventor: Youzou Matsuzaka, Tokyo, Japan**  
[73] **Assignee: Sony Corporation, Tokyo, Japan**  
[\*\*] **Term: 14 Years**

[21] **Appl. No.: 54,575**  
[22] **Filed: May 15, 1996**

[30] **Foreign Application Priority Data**

Jan. 29, 1996 [KR] Rep. of Korea ..... 1996-1324

[51] **LOC (6) Cl. .... 14-01**  
[52] **U.S. Cl. .... D14/165**  
[58] **Field of Search ..... D14/160-168,  
D14/188, 192-198, 260; 455/344, 347-351**

[56] **References Cited**

**U.S. PATENT DOCUMENTS**

D. 320,017 9/1991 Ikeyama et al. .... D14/163 X  
D. 350,751 9/1994 Matsuzaka ..... D14/163 X  
D. 350,959 9/1994 Sumikawa ..... D14/163  
D. 351,168 10/1994 Sumikawa ..... D14/163 X

*Primary Examiner*—Sandra L. Morris  
*Assistant Examiner*—Nanda Bondade  
*Attorney, Agent, or Firm*—Foley & Lardner

[57] **CLAIM**

The ornamental design for a tape player, as shown and described.

**DESCRIPTION**

FIG. 1 is a perspective view of a first embodiment of a tape player showing my new design;  
FIG. 2 is a perspective view thereof with the main door in the open position;  
FIG. 3 is a top plan view of FIG. 1;  
FIG. 4 is a left side elevational view thereof;  
FIG. 5 is a front elevational view thereof;  
FIG. 6 is a right side elevational view thereof;  
FIG. 7 is a bottom plan view thereof;  
FIG. 8 is a rear elevational view thereof;  
FIG. 9 is a perspective view of a second embodiment of FIG. 1;  
FIG. 10 is a perspective view of the embodiment of FIG. 9 with the main door in the open position;  
FIG. 11 is a top plan view of the embodiment of FIG. 9;  
FIG. 12 is a left side elevational view of the embodiment of FIG. 9;  
FIG. 13 is a front elevational view of the embodiment of FIG. 9;  
FIG. 14 is a right side elevational view of the embodiment of FIG. 9;  
FIG. 15 is a bottom plan view of the embodiment of FIG. 9; and,  
FIG. 16 is a rear elevational view of the embodiment of FIG. 9.

**1 Claim, 6 Drawing Sheets**

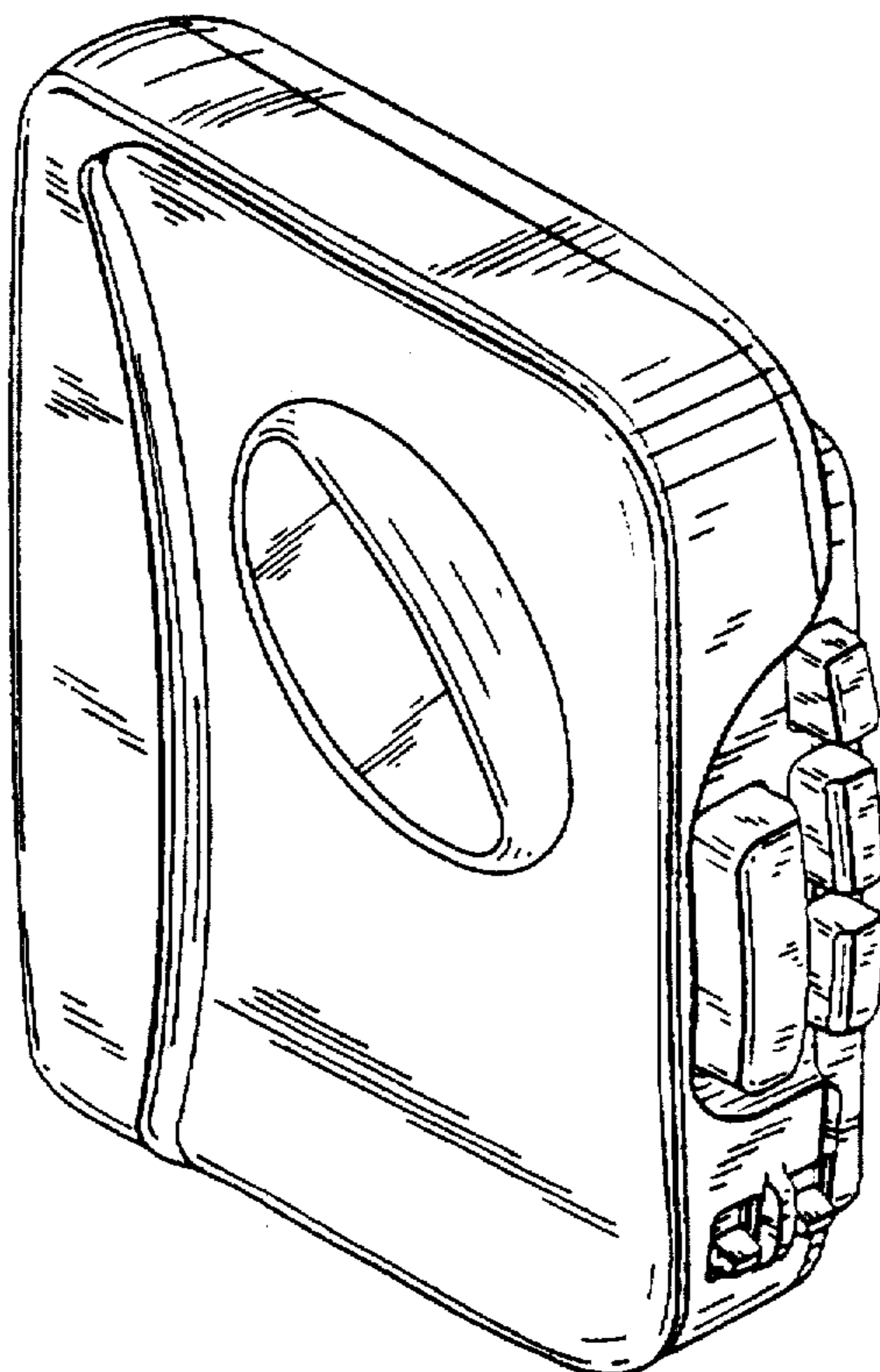
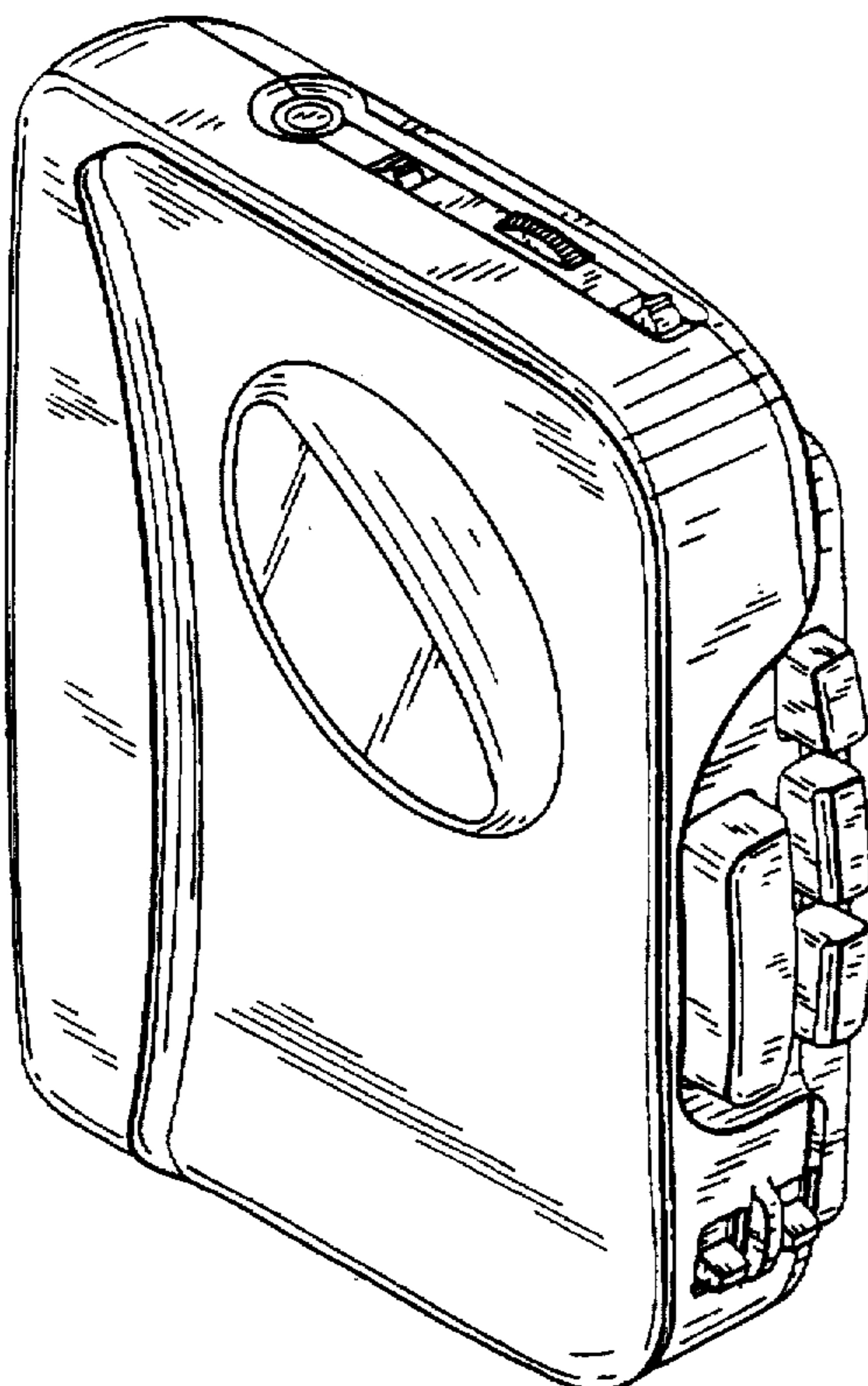

FIG. 2

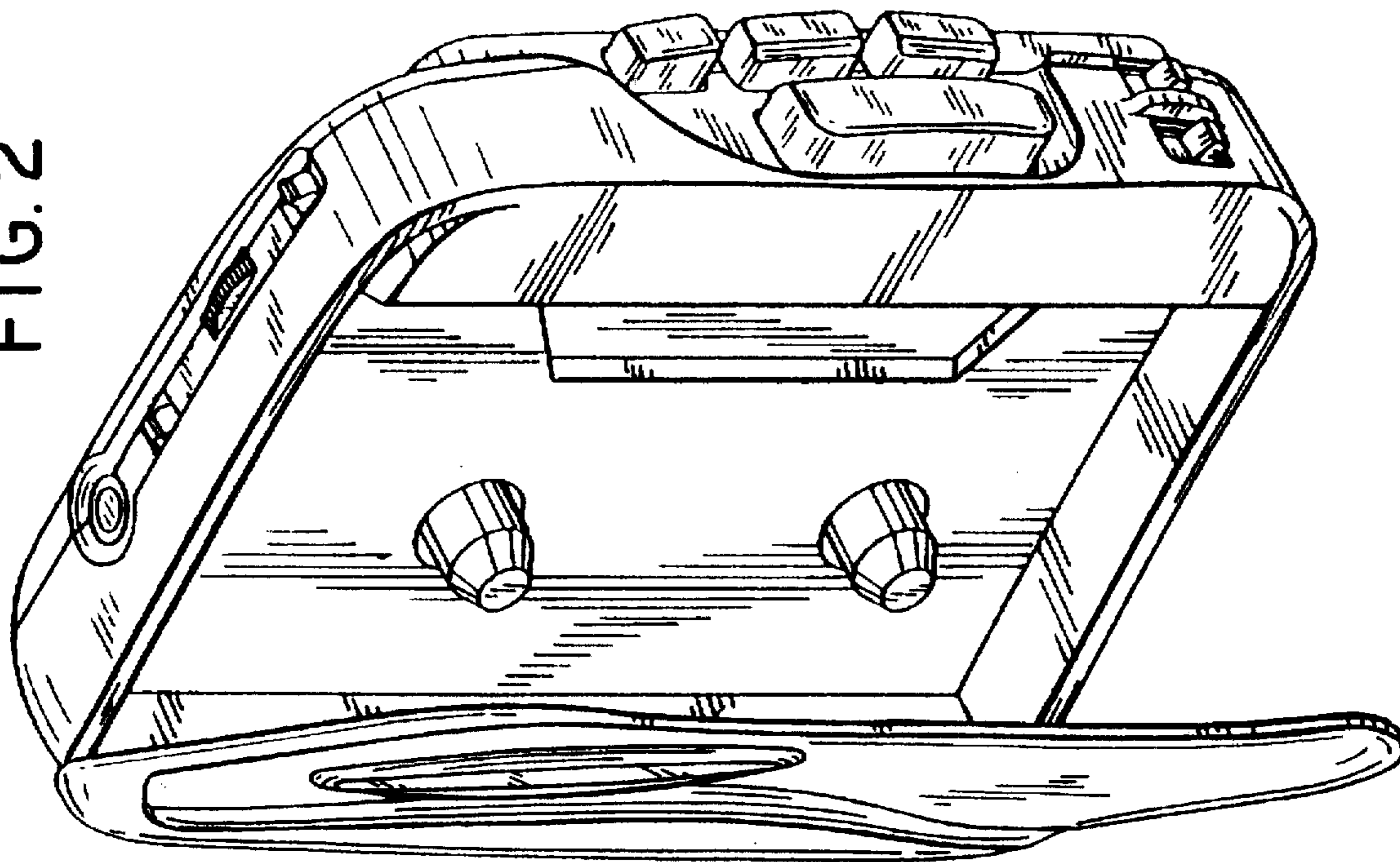

FIG. 1

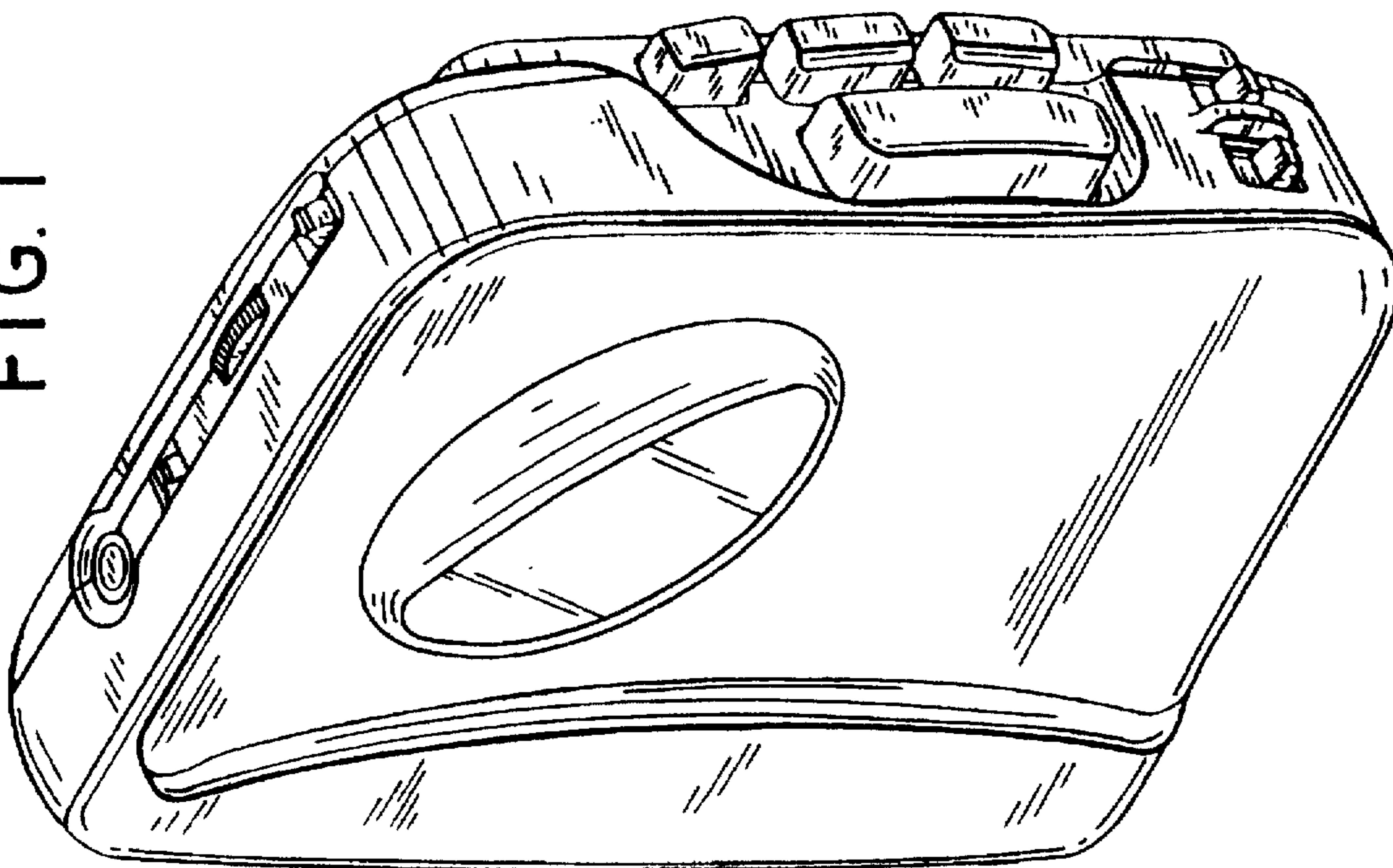

FIG. 3

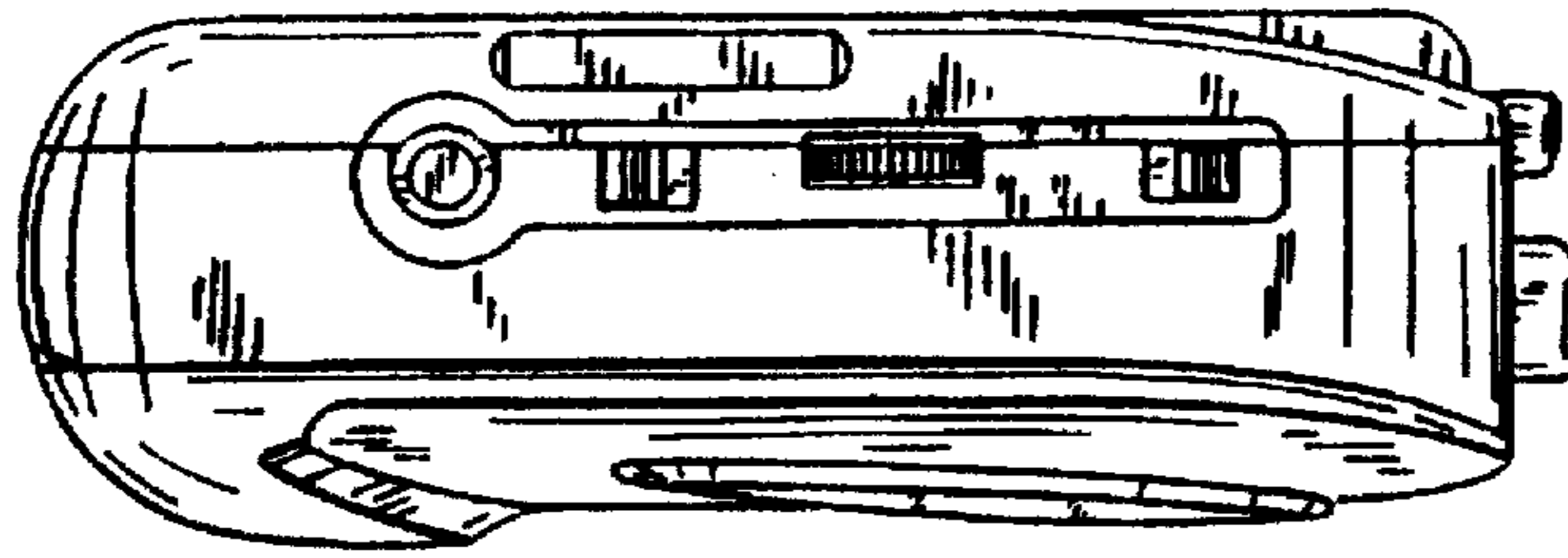

FIG. 4

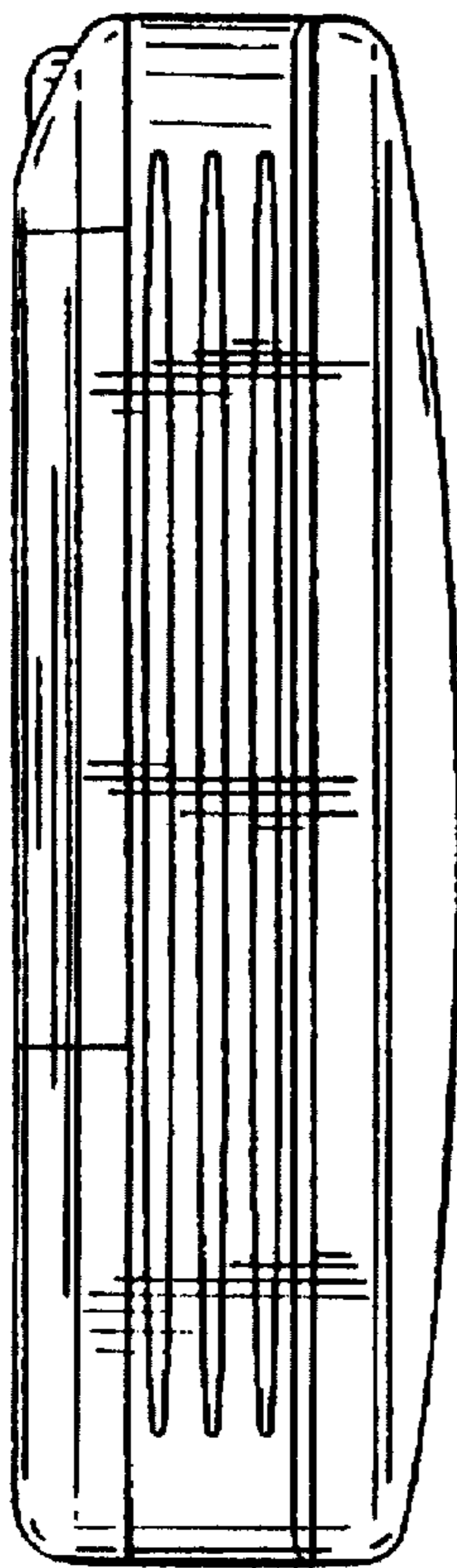

FIG. 6

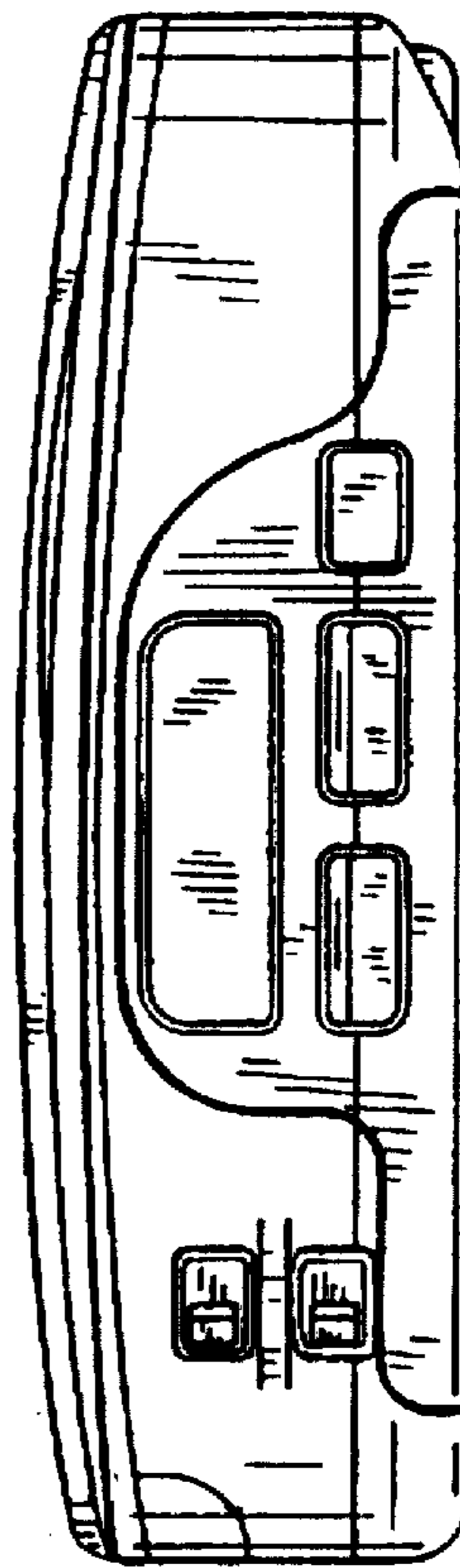

FIG. 7

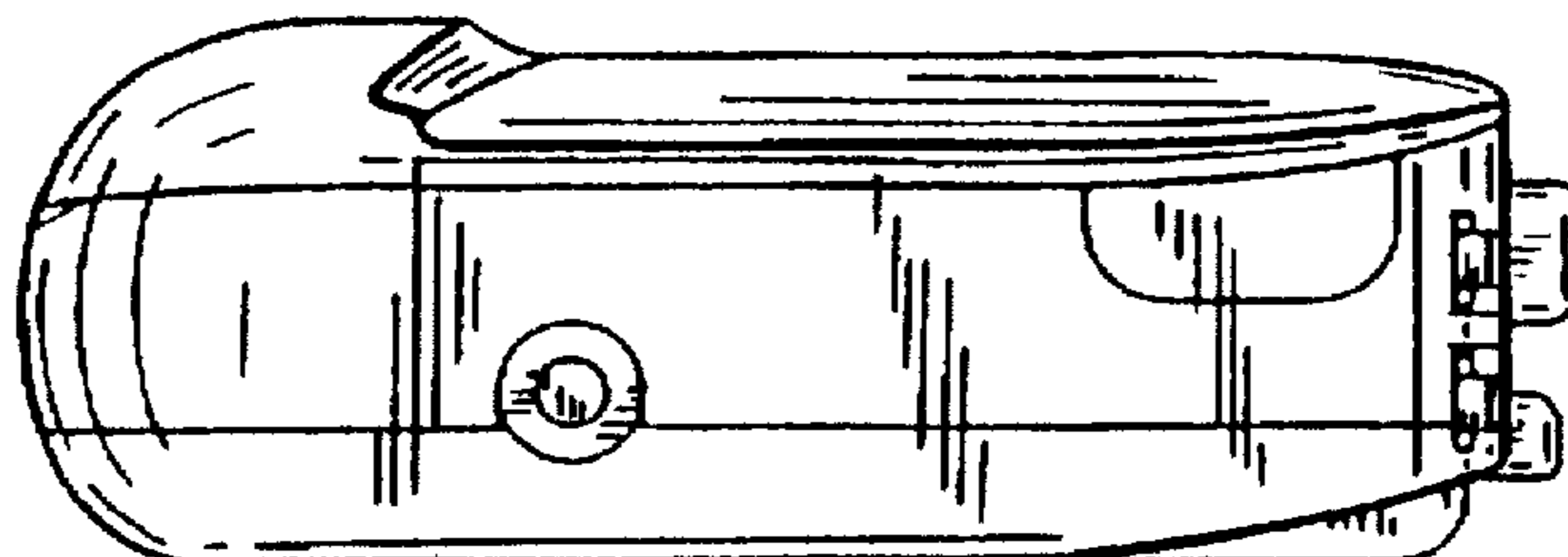

FIG. 5

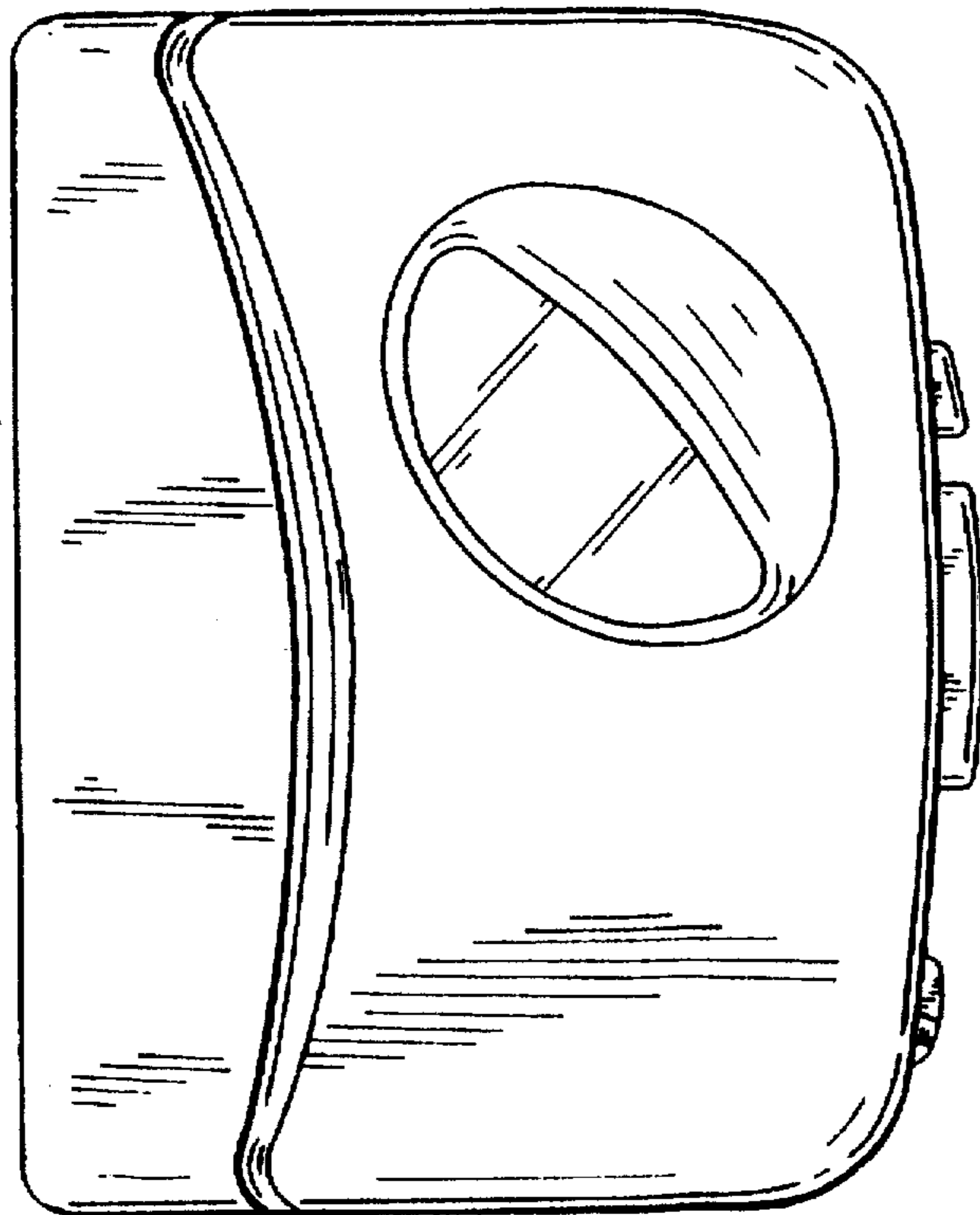

FIG. 8

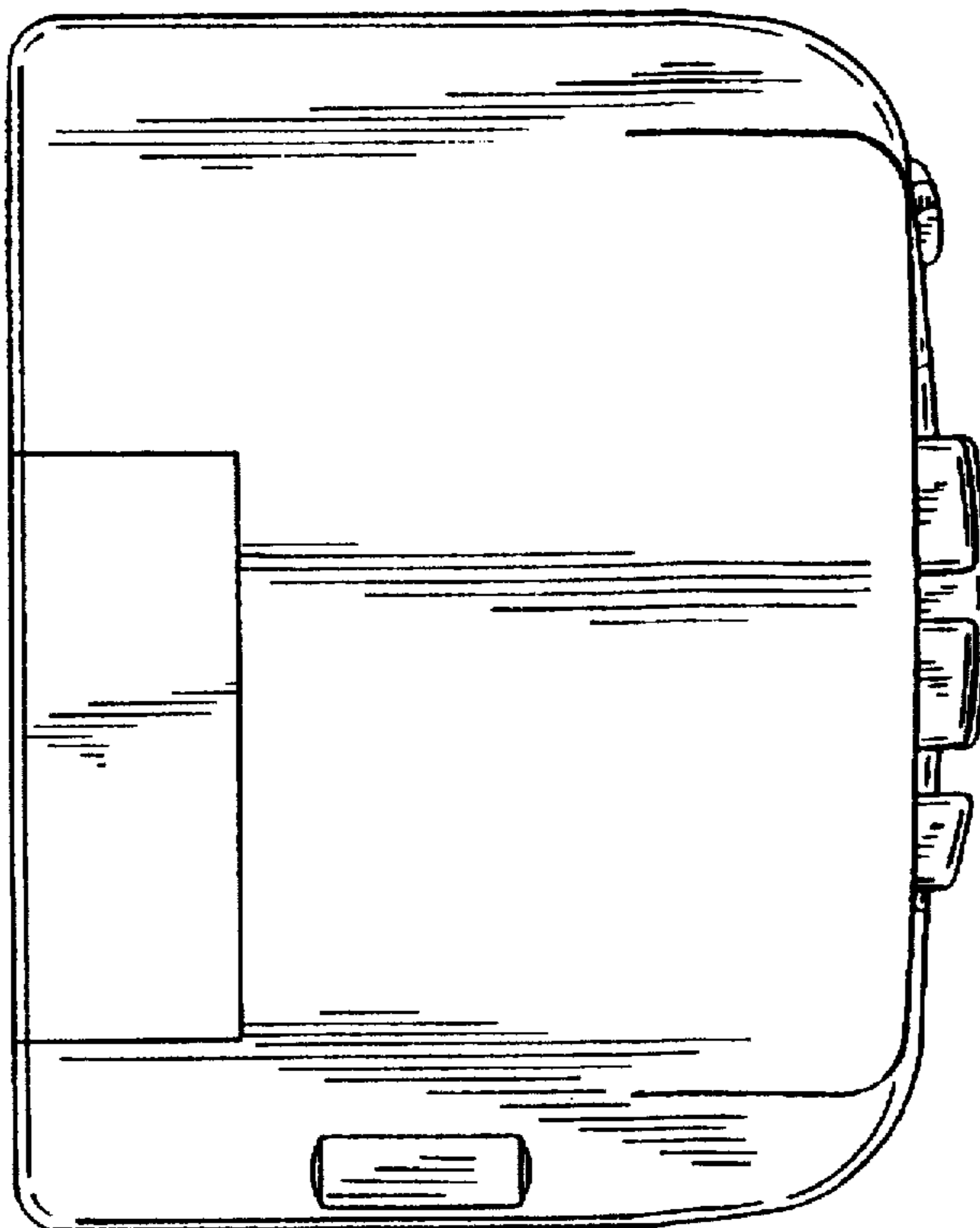

FIG. 10

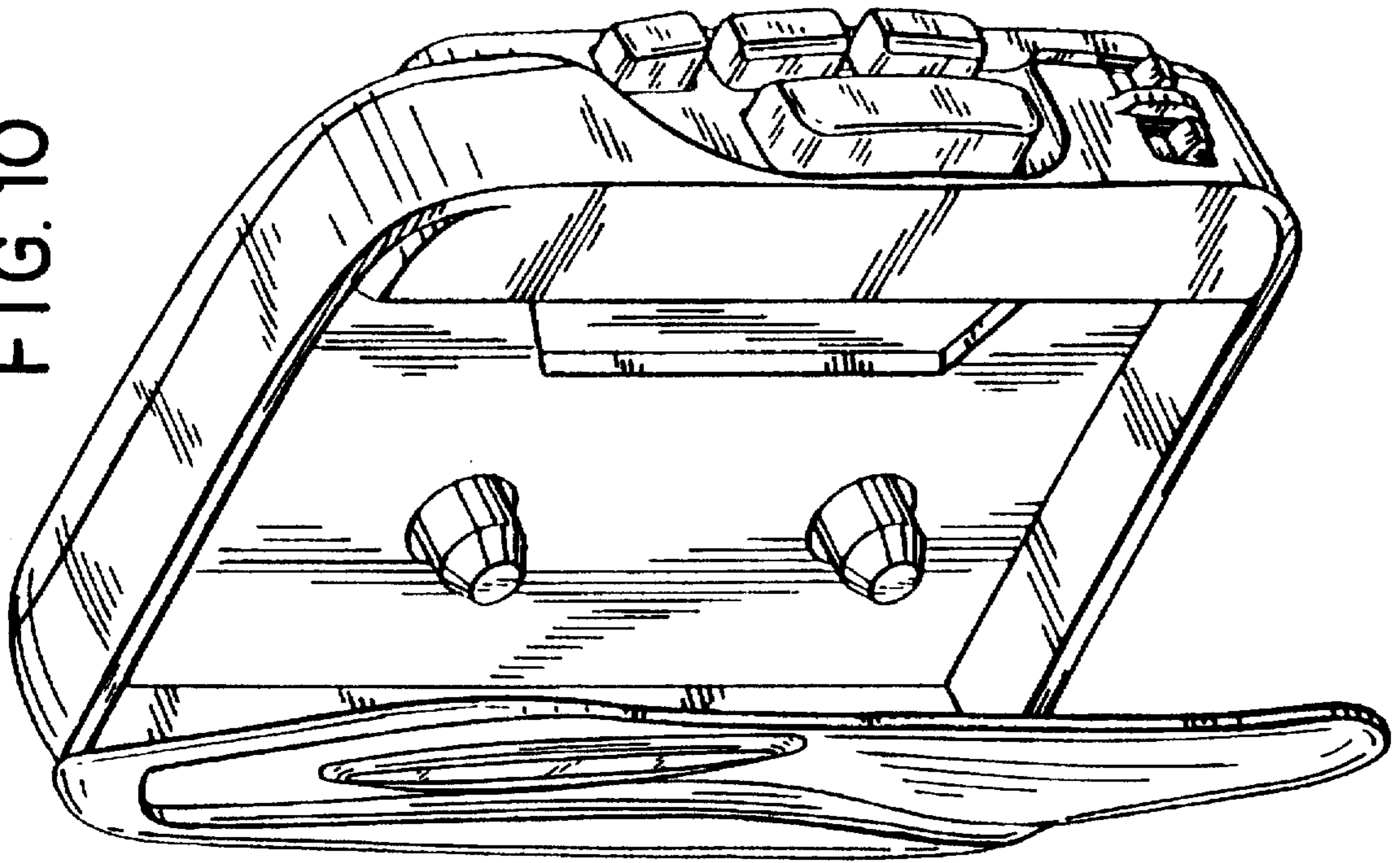

FIG. 9

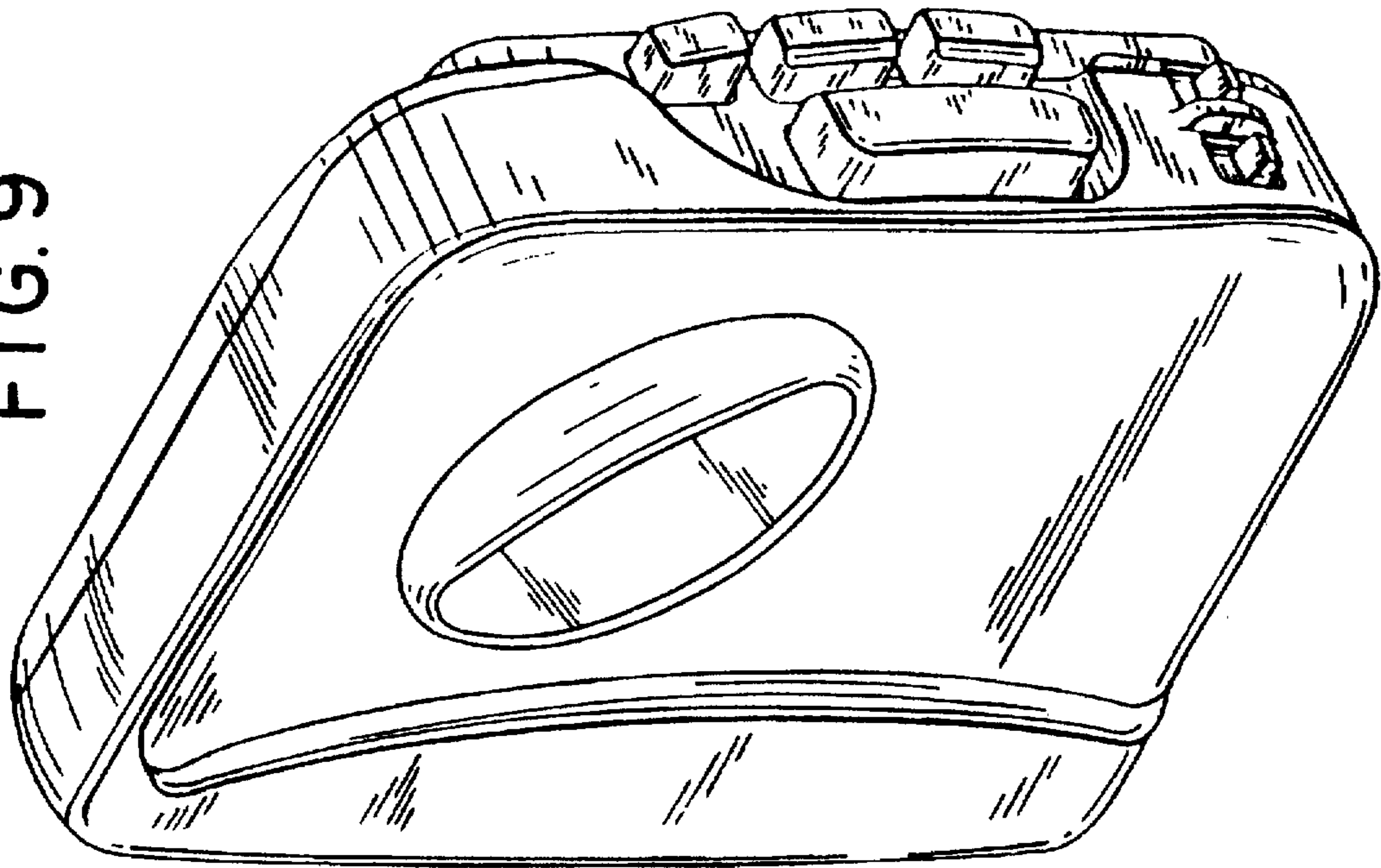

FIG. 11

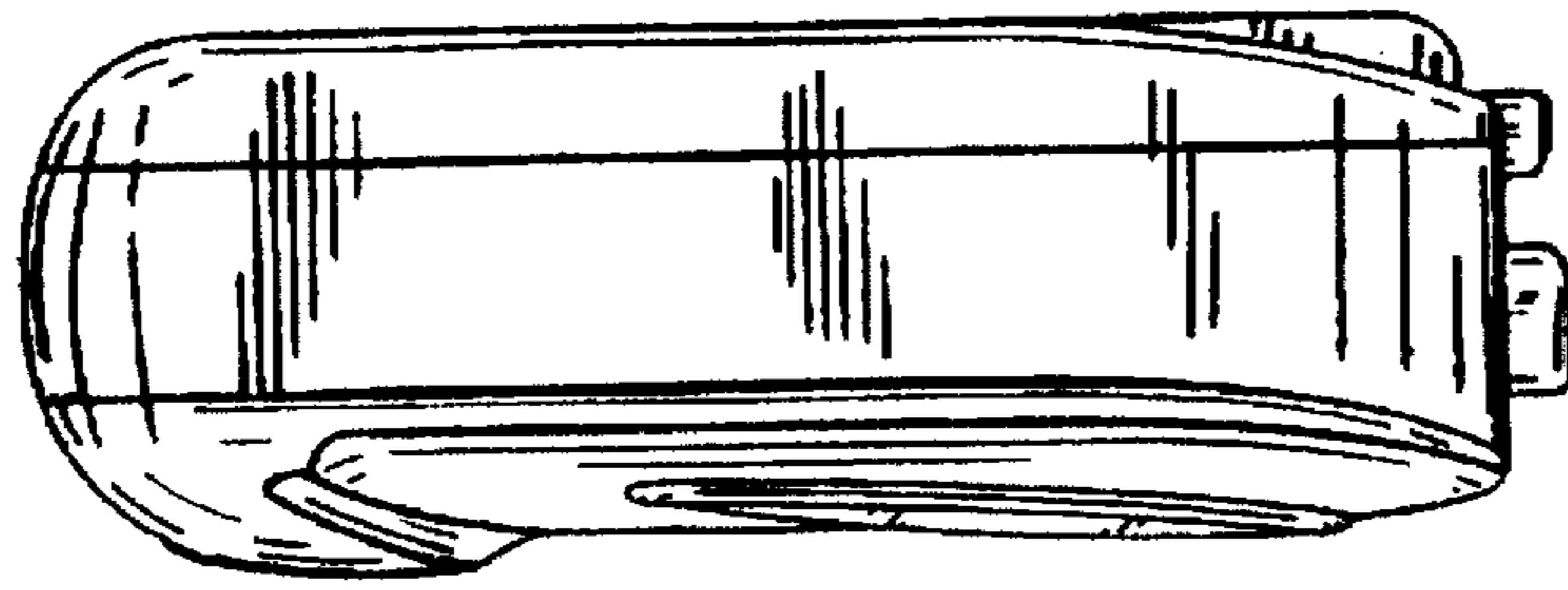

FIG. 12

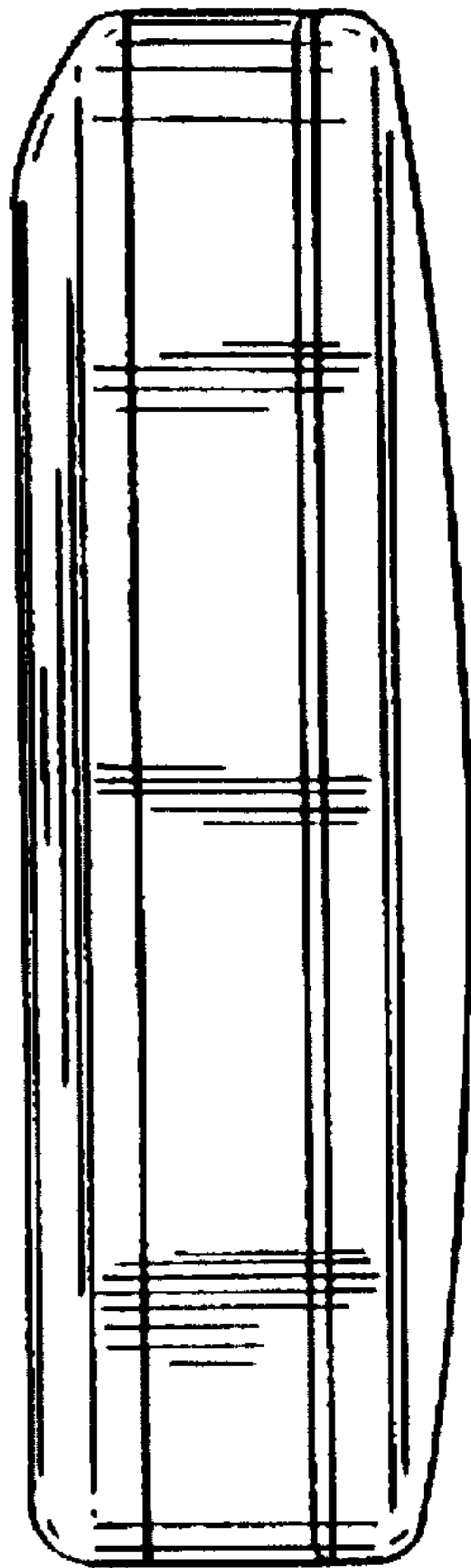

FIG. 14

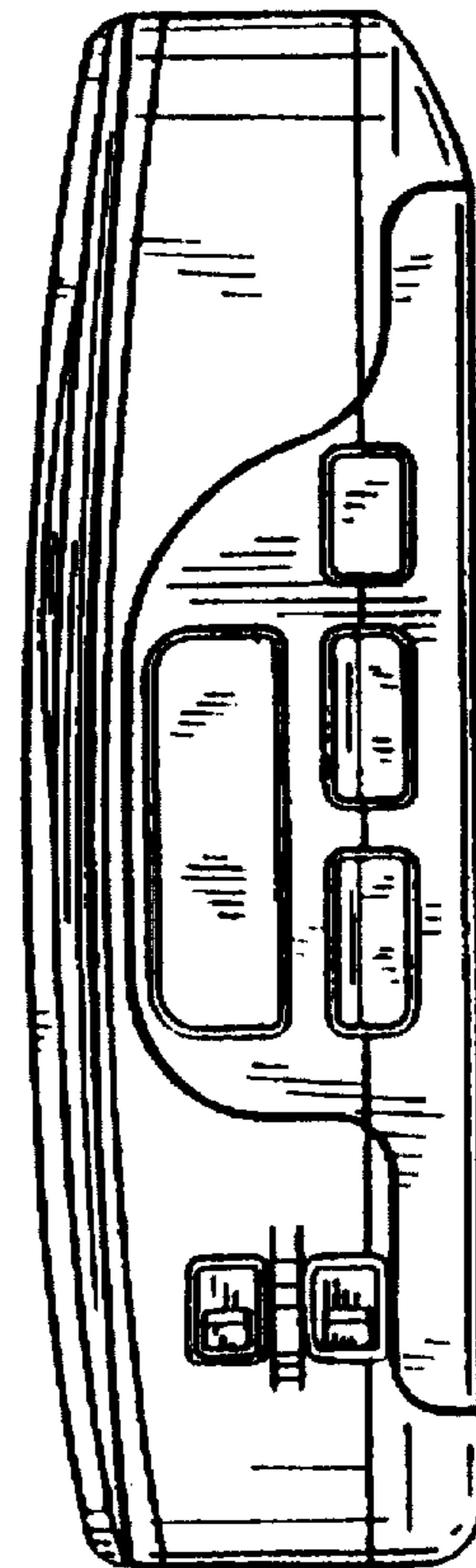

FIG. 15

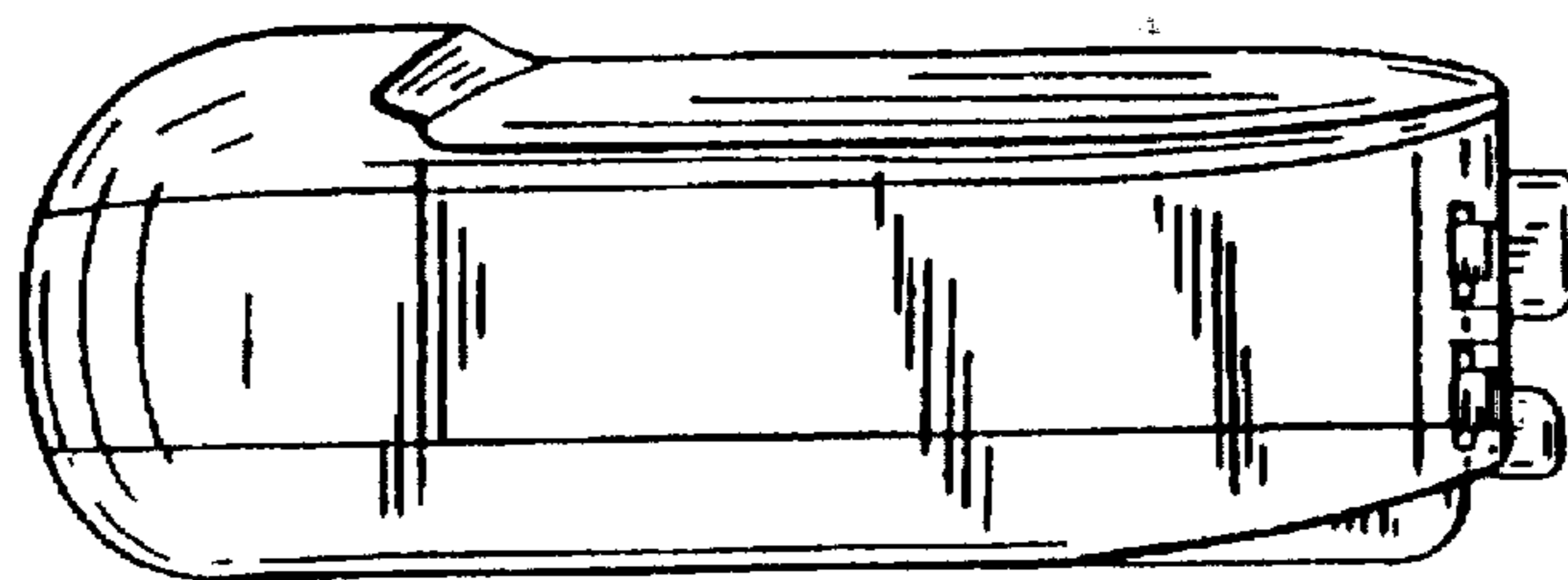

FIG. 13

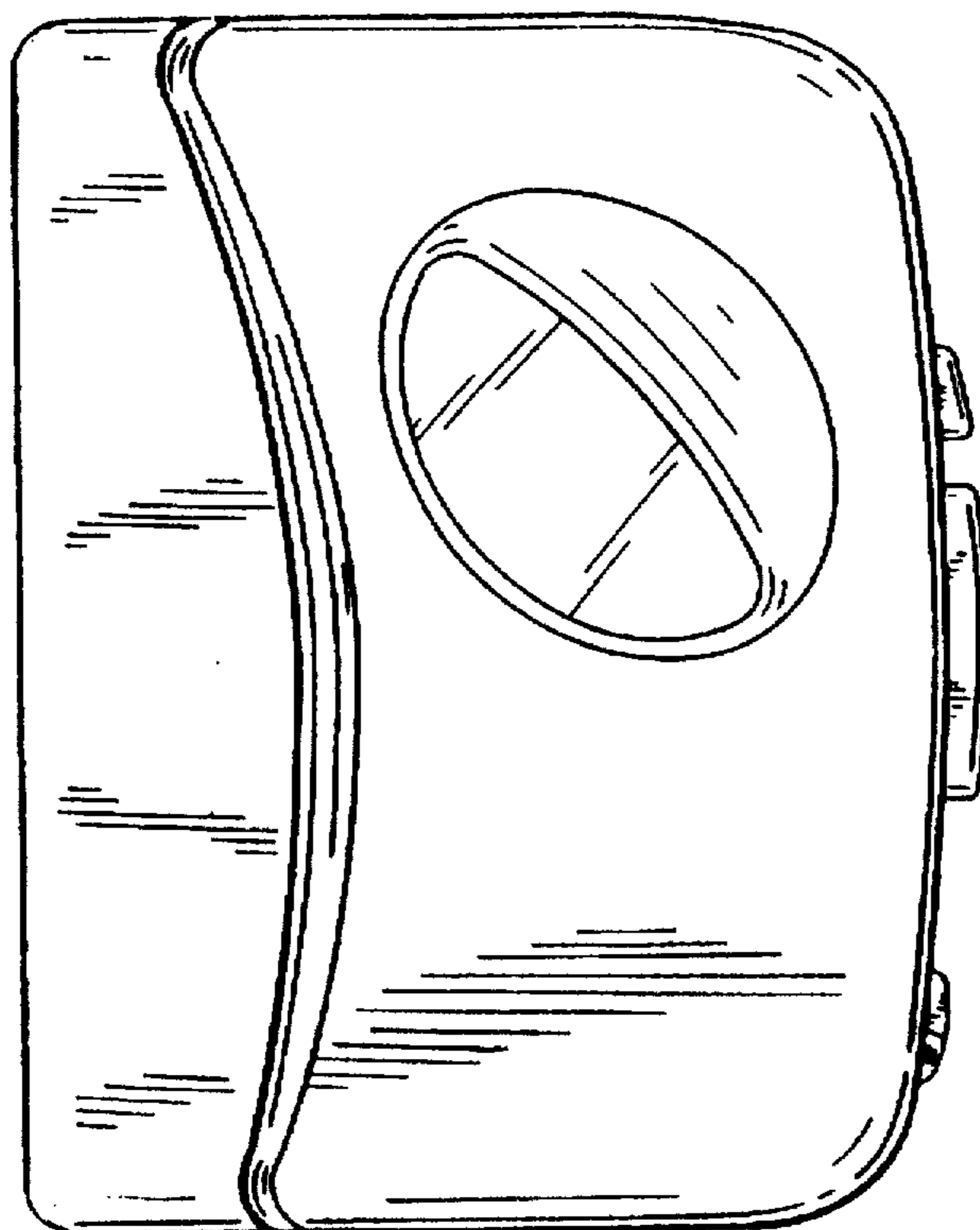

FIG. 16

