



US00D383728S

United States Patent [19]

[11] Patent Number: **Des. 383,728**

Yurkonis et al.

[45] Date of Patent: ****Sep. 16, 1997**

[54] **COMBINED COMPUTER HOUSING AND STAND THEREFOR**

Primary Examiner—Freda Nunn
Attorney, Agent, or Firm—Blakely, Sokoloff, Taylor & Zafman

[75] Inventors: **Philip G. Yurkonis**, Campbell; **Mike Antonczak**, Aptos; **Michael Dann**, Mountain View; **Steven J. Furuta**, Santa Clara; **Herbert Pfeifer**; **Paul Montgomery**, both of San Francisco, all of Calif.

[57] **CLAIM**

The ornamental design for a combined computer housing and stand therefor, as shown and described.

[73] Assignee: **Sun Microsystems, Inc.**, Mountain View, Calif.

DESCRIPTION

[**] Term: **14 Years**

FIG. 1 is a front right and top perspective view of a combined computer housing and stand therefor showing our new design wherein the computer housing is shown separately for clarity of illustration only;
FIG. 2 is a top plan view of the computer housing;
FIG. 3 is a front elevational view of the computer housing;
FIG. 4 is a bottom plan view of the computer housing;
FIG. 5 is a left side elevational view of the computer housing;
FIG. 6 is a right side elevational view of the computer housing;
FIG. 7 is a rear elevational view of the computer housing;
FIG. 8 is a perspective view of the combined computer housing and stand therefor;
FIG. 9 is a top plan view of the stand thereof shown separately for clarity of illustration only;
FIG. 10 is a right side elevational view thereof;
FIG. 11 is a left side elevational view thereof;
FIG. 12 is a rear elevational view thereof;
FIG. 13 is a front elevational view thereof;
FIG. 14 is a bottom plan view thereof; and,
FIG. 15 is a front right and top perspective view thereof.

[21] Appl. No.: **46,074**

[22] Filed: **Nov. 7, 1995**

[51] LOC (6) Cl. **14-02**

[52] U.S. Cl. **D14/100**

[58] Field of Search D14/100, 102, D14/107-109; D13/162, 184, 199; D6/432, 436, 445, 448; 312/208.1, 254, 292; 360/97.01, 97.04, 98.01, 99.01, 99.12; 361/680-695

[56] **References Cited**

U.S. PATENT DOCUMENTS

D. 296,899	7/1988	Chu et al.	D14/107 X
D. 330,021	10/1992	Kline et al.	D14/114
D. 341,132	11/1993	Hui	D14/107
D. 342,724	12/1993	Yurkonis et al.	D14/109 X
D. 351,147	10/1994	Hill	D14/109
D. 360,409	7/1995	Alo, Jr. et al.	D14/102

1 Claim, 7 Drawing Sheets

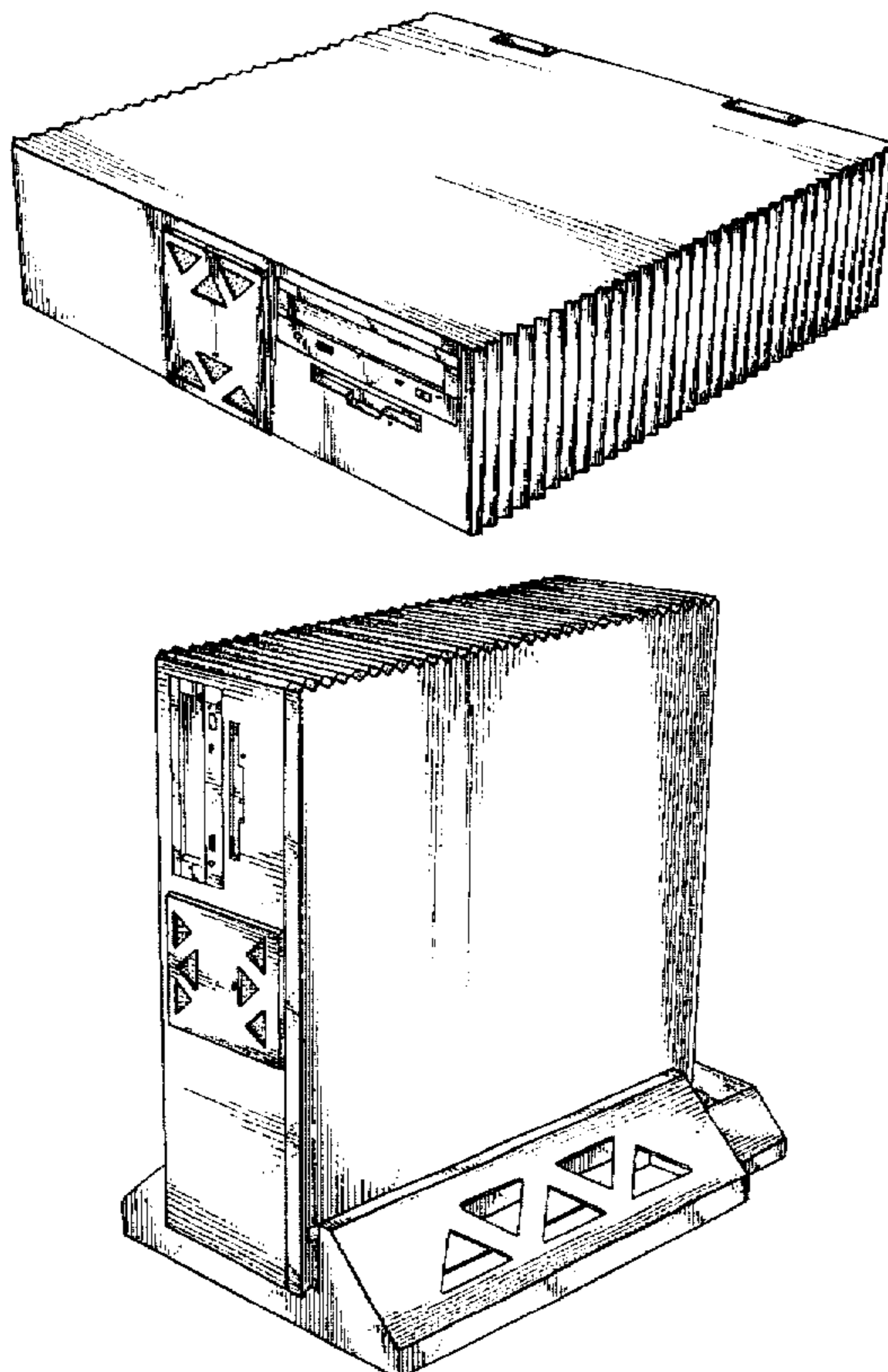

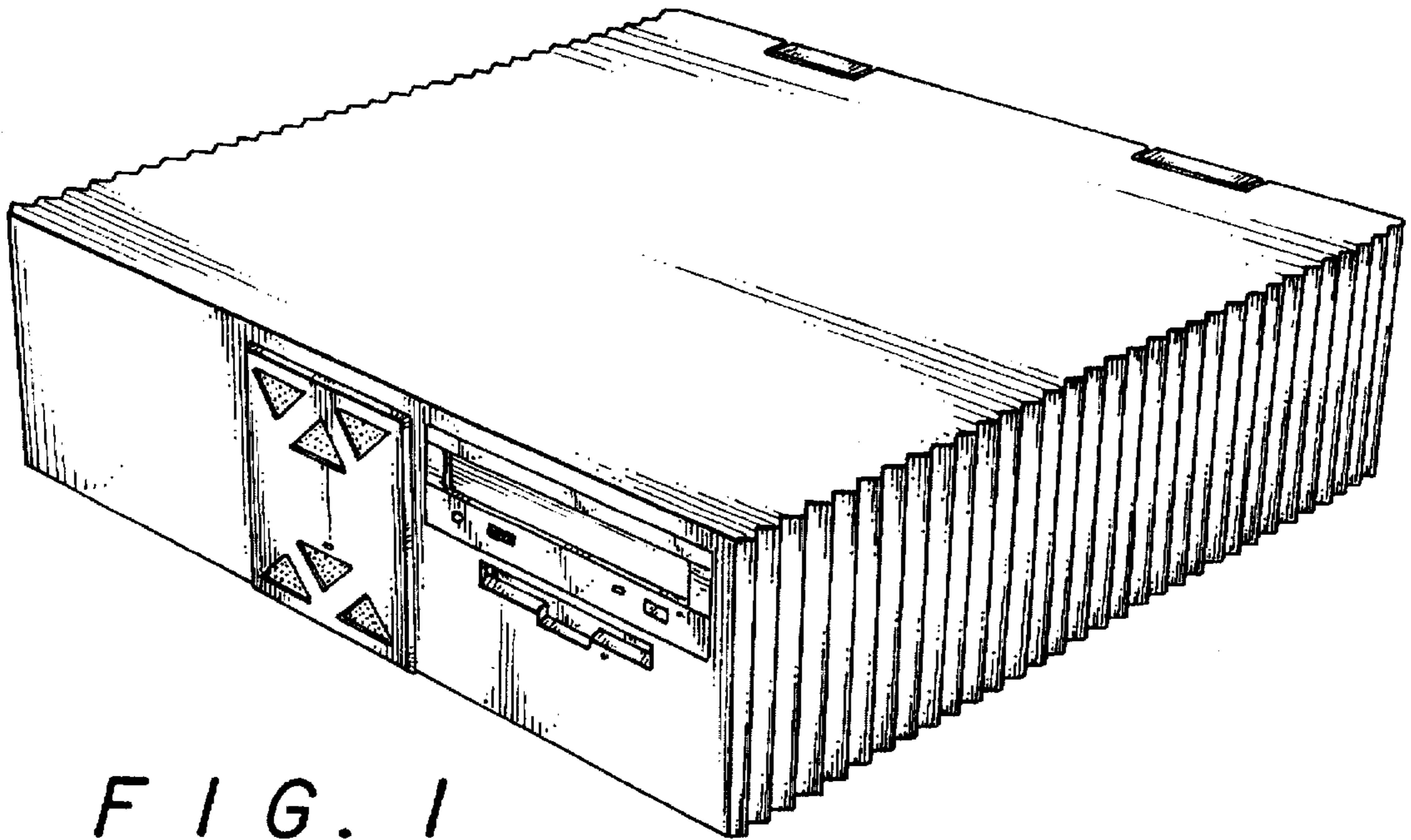

FIG. 1

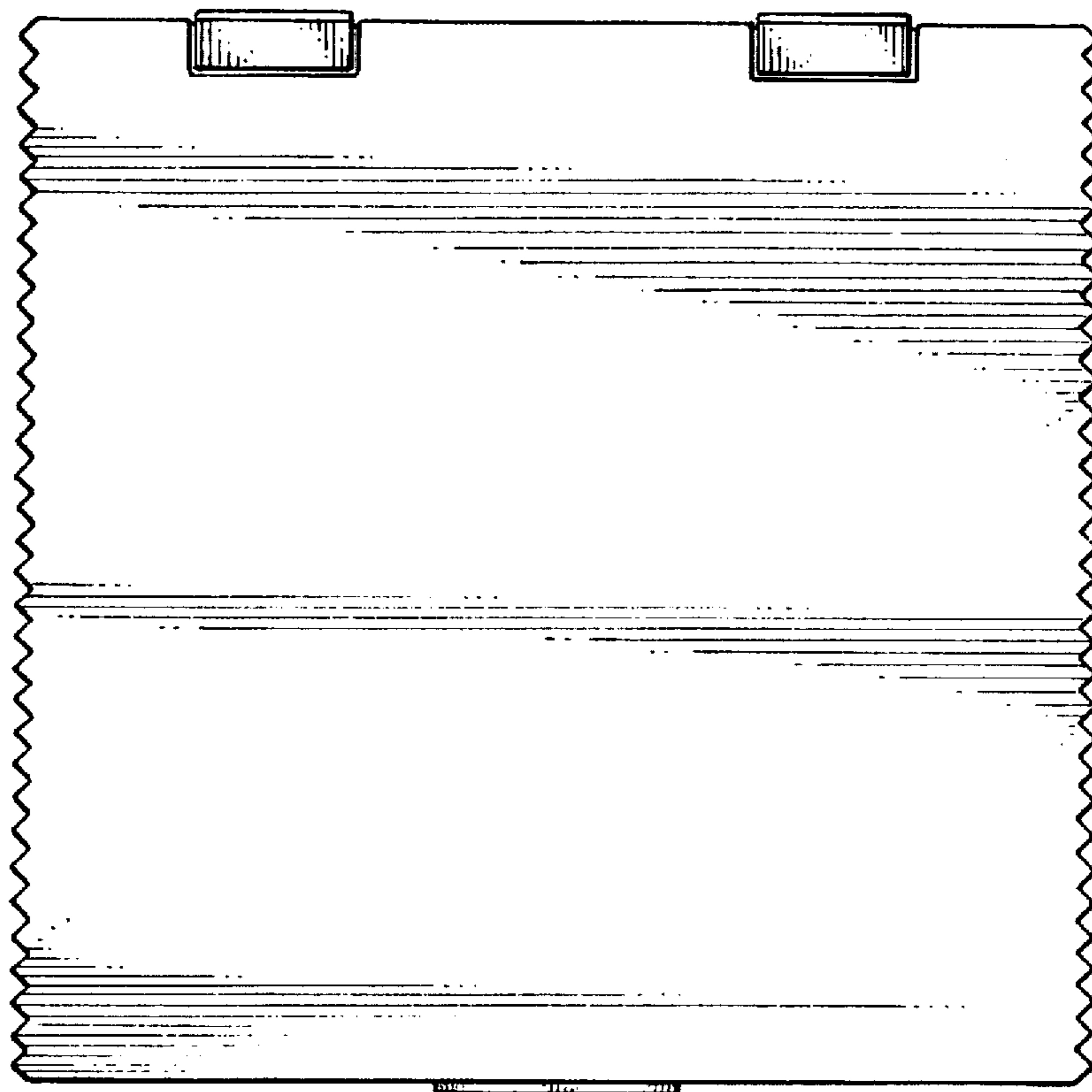

FIG. 2

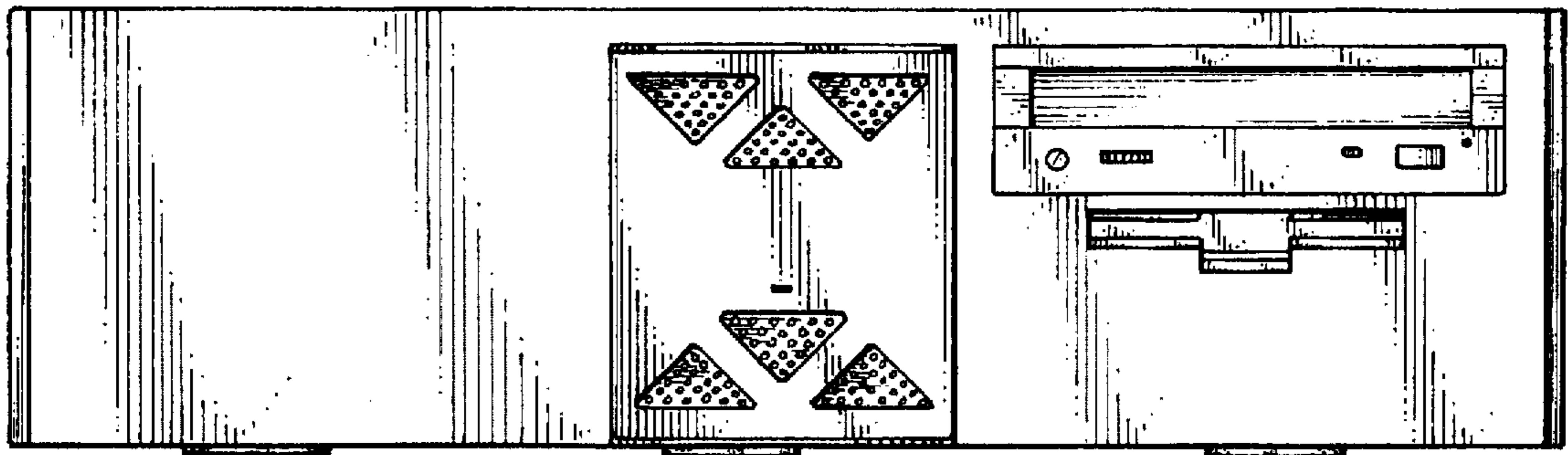

FIG. 3

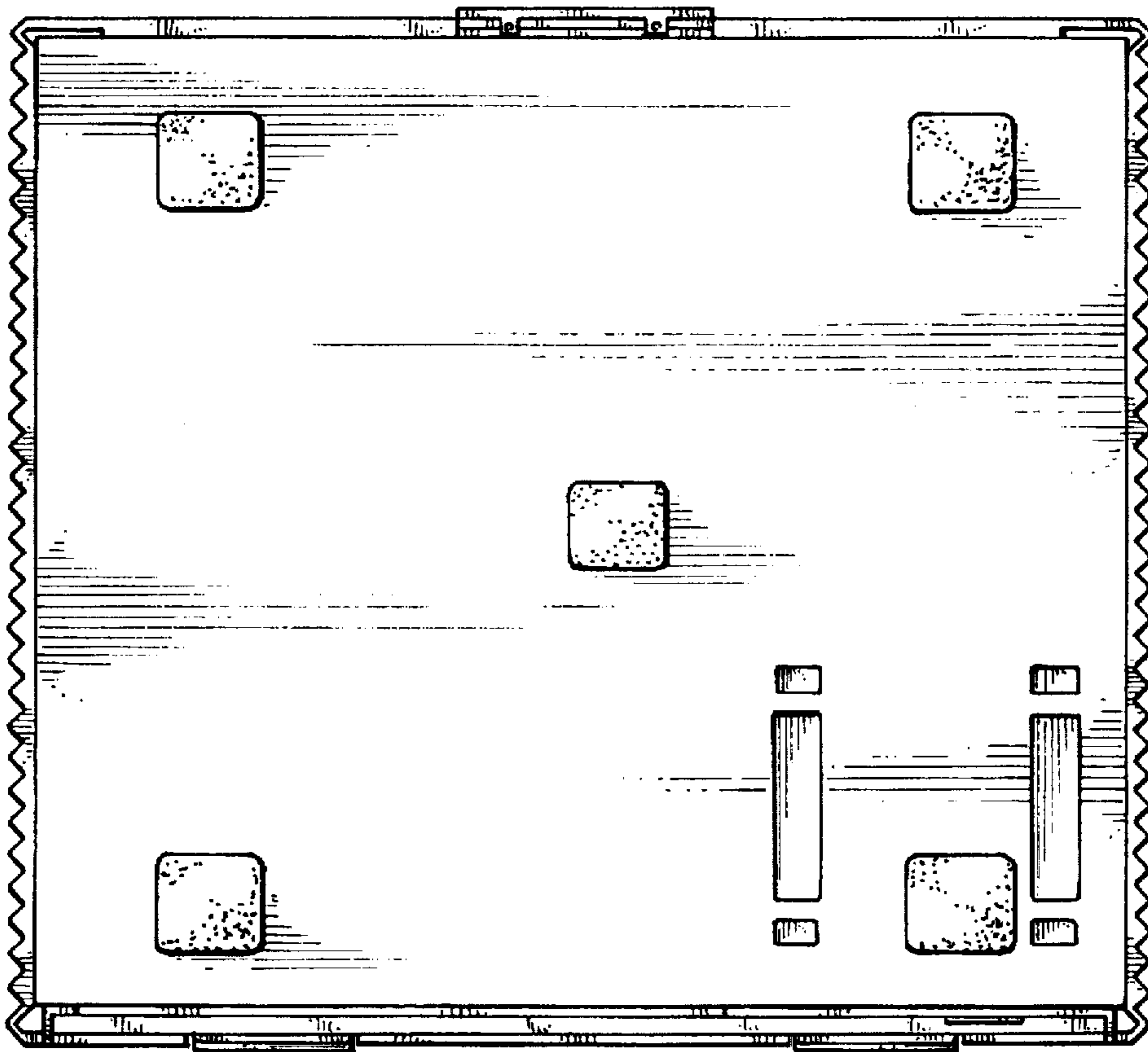

FIG. 4

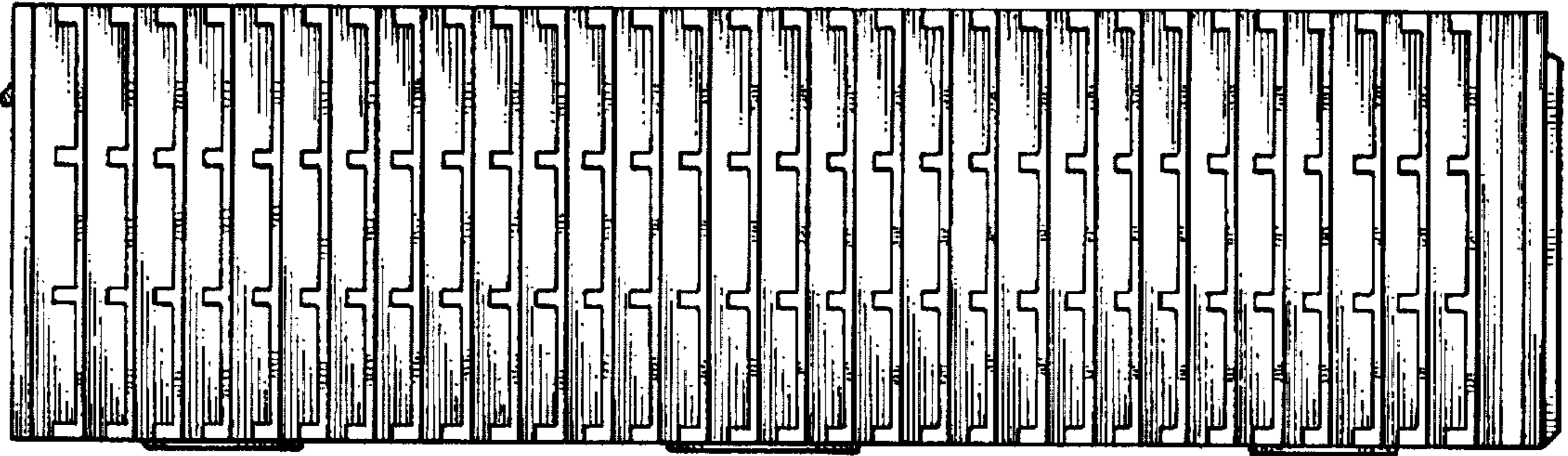

FIG. 5

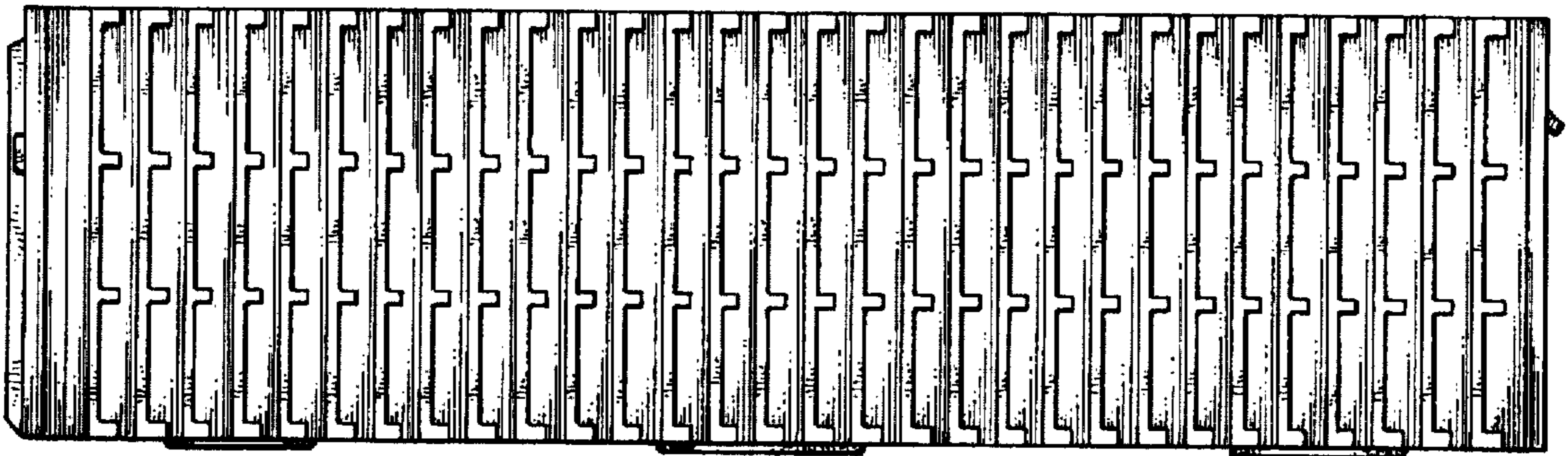

FIG. 6

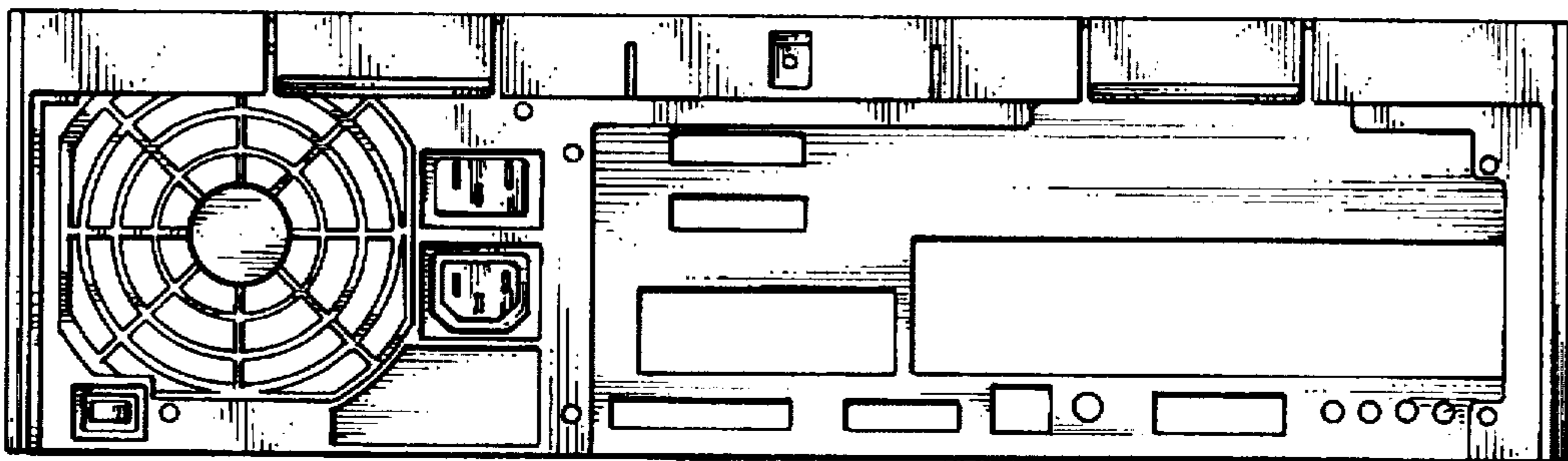

FIG. 7

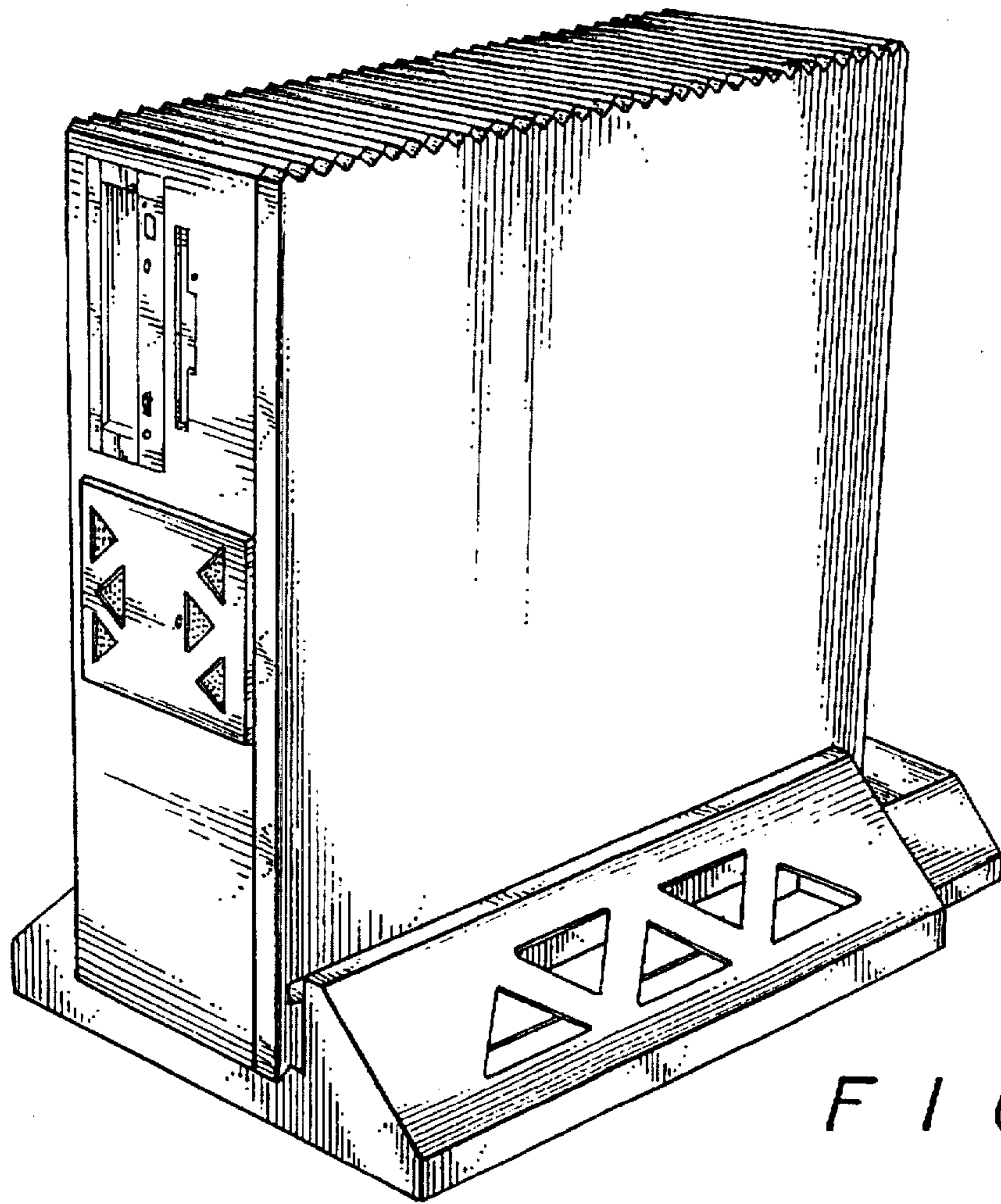

FIG. 8

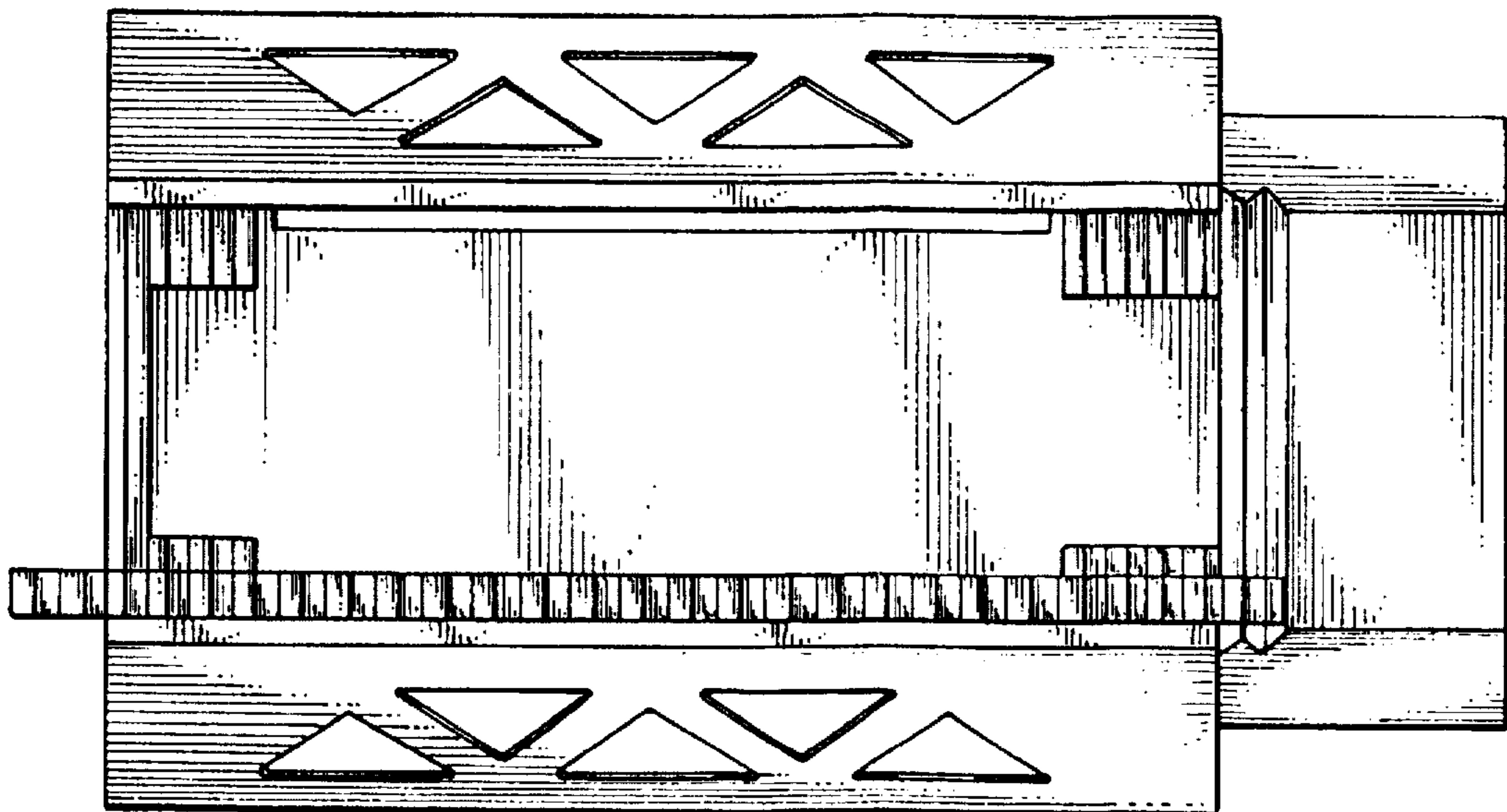

FIG. 9

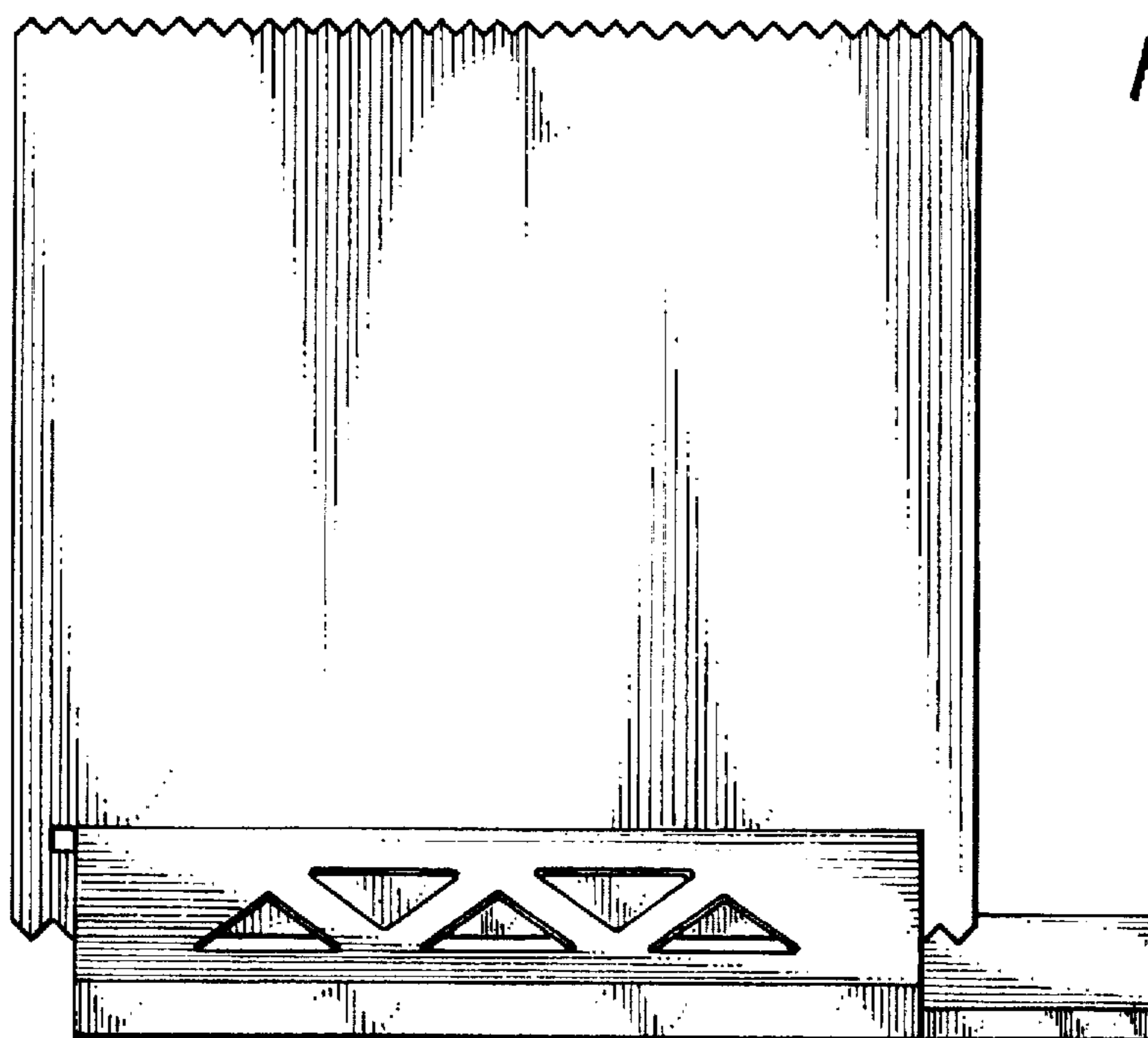

FIG. 10

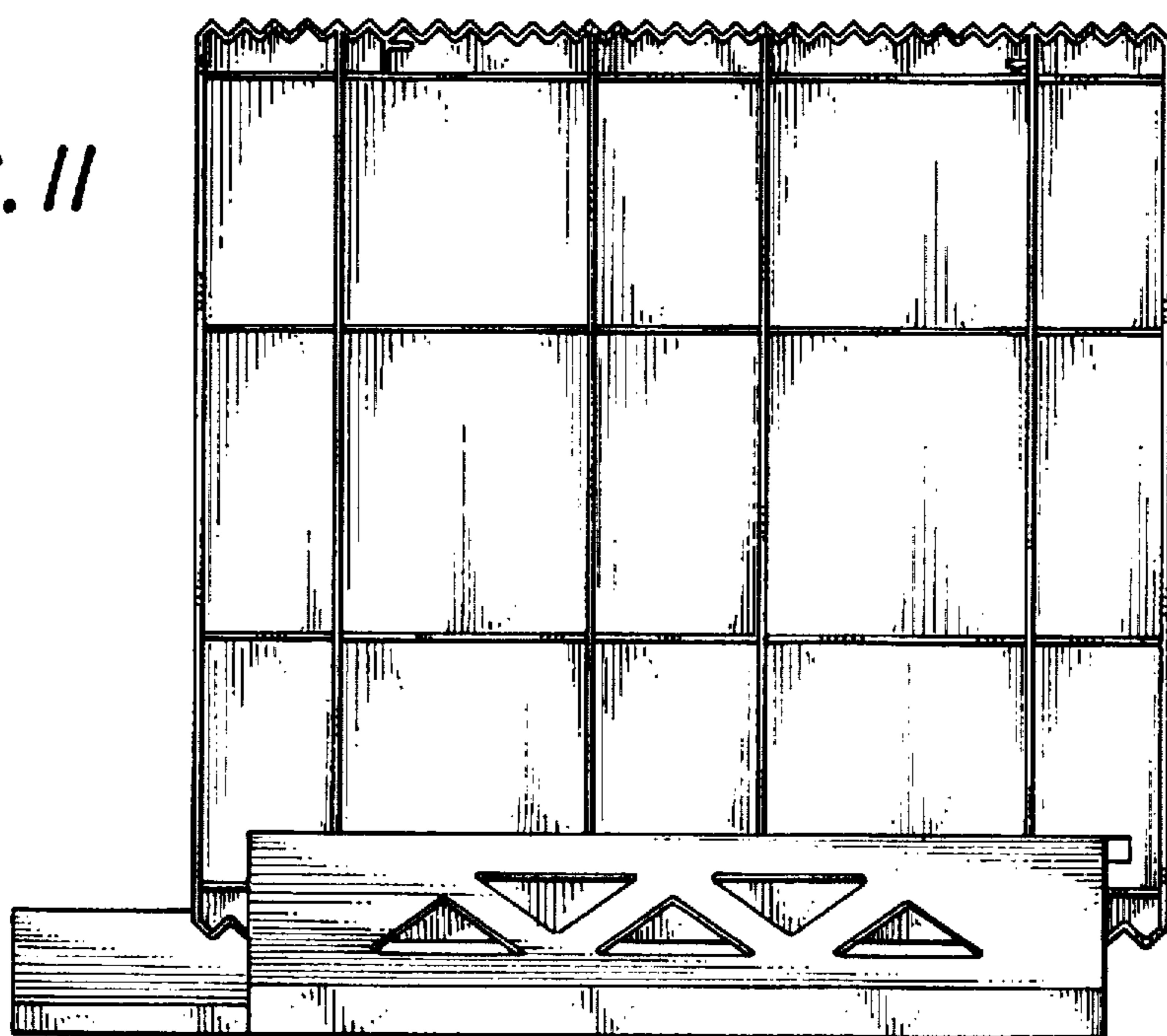

FIG. 11

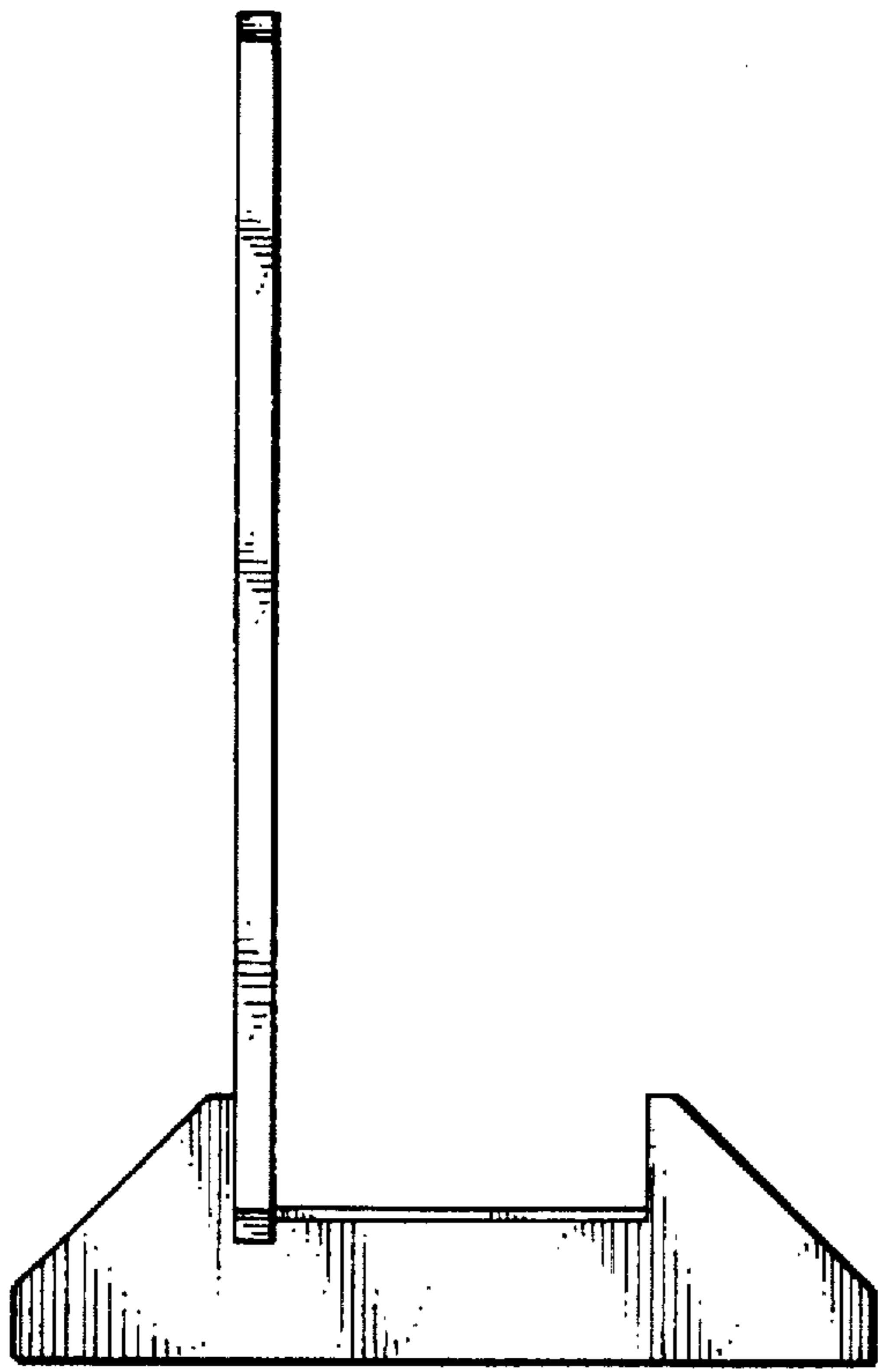

FIG. 12

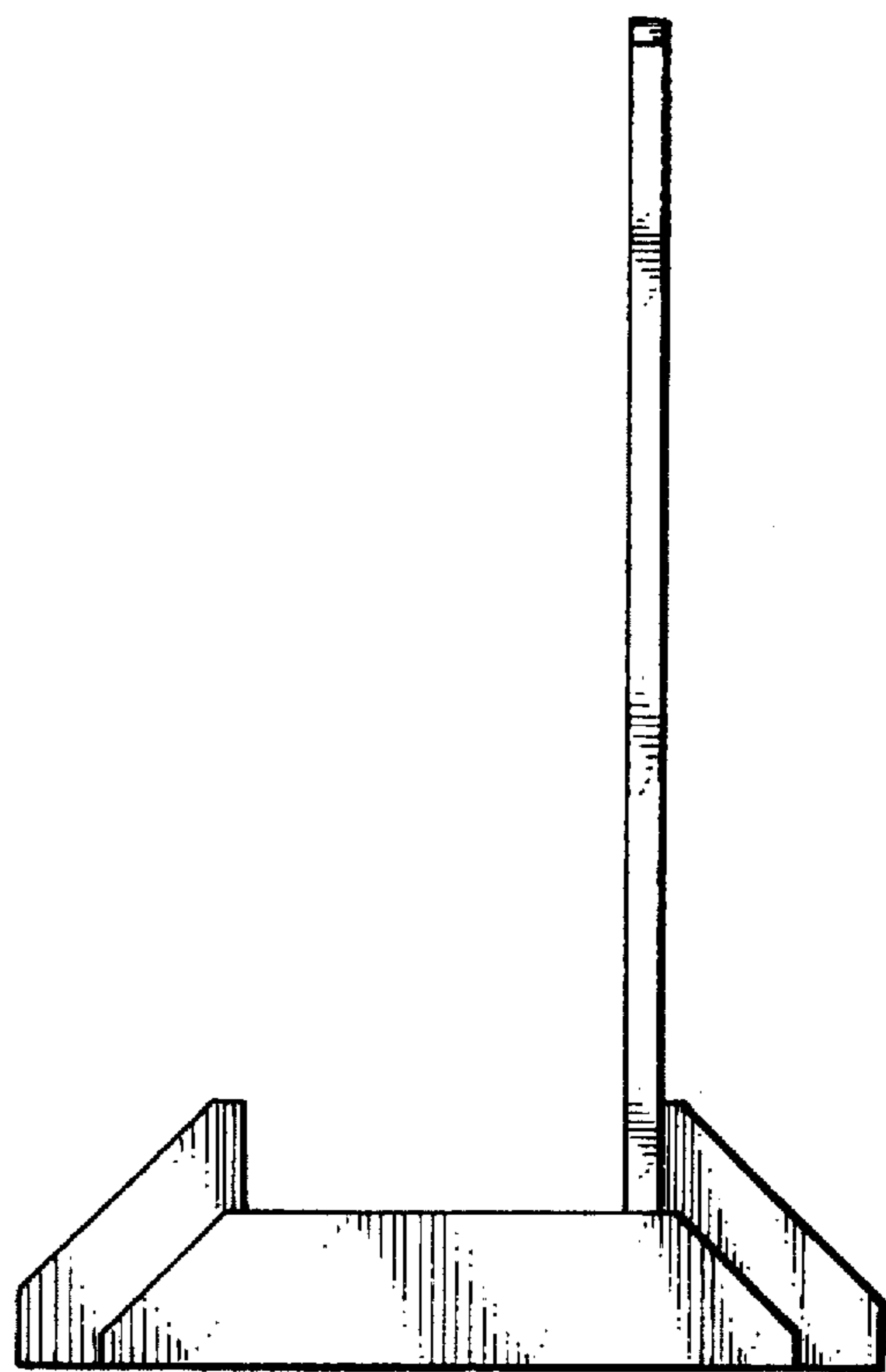

FIG. 13

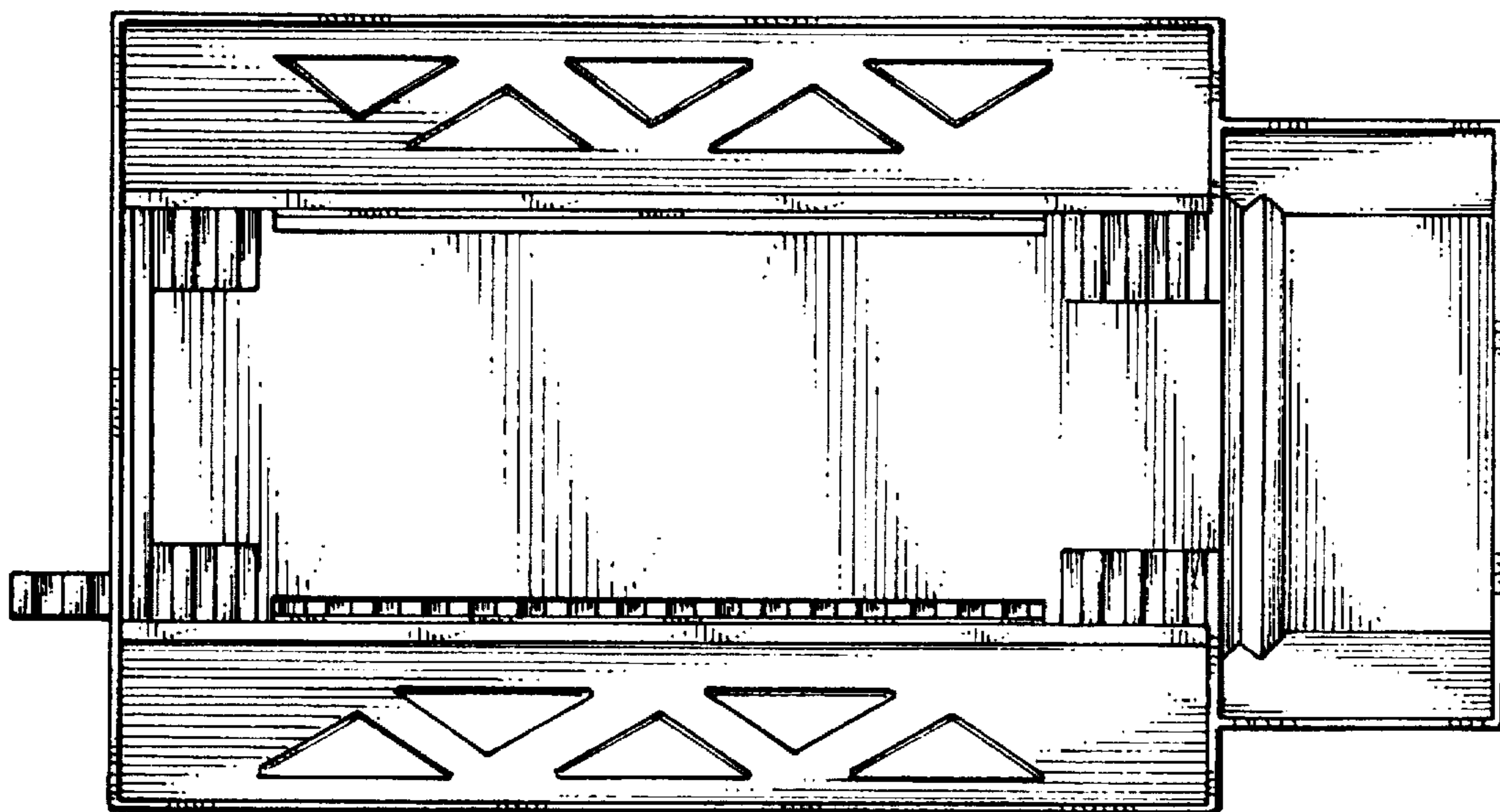

FIG. 14

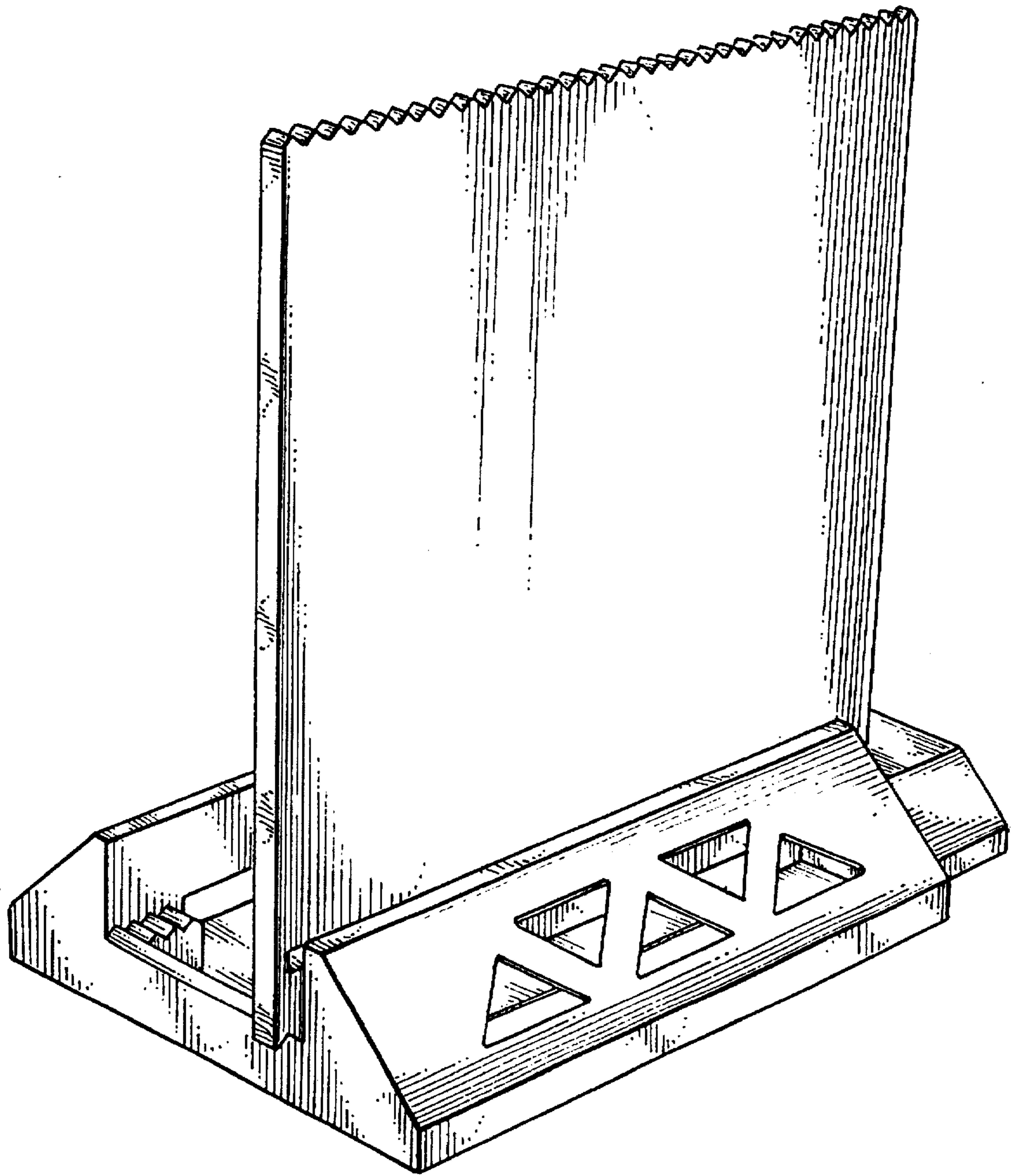

FIG. 15