

US00D383640S

United States Patent [19]

[11] Patent Number: **Des. 383,640**

Yu

[45] Date of Patent: ****Sep. 16, 1997**

[54] **BARBECUE COOKER**

D. 367,799	3/1996	Pai	D7/332
4,463,746	8/1984	Knuth et al.	D7/332
4,788,962	12/1988	Mashtown et al.	D7/332

[76] Inventor: **Norman Y.C. Yu**, No. 57, Sec. 1, Ten-Sin Rd., Fong-Yuan City, Taichung Hsien, Taiwan

Primary Examiner—Ruth McInroy
Attorney, Agent, or Firm—Bacon & Thomas

[**] Term: **14 Years**

[57] **CLAIM**

[21] Appl. No.: **56,309**

The ornamental design for a barbecue cooker, as shown and described.

[22] Filed: **Jun. 26, 1996**

DESCRIPTION

[51] LOC (6) Cl. **07-02**

[52] U.S. Cl. **D7/337; D7/332**

[58] Field of Search **D7/332-337; 126/25 R, 126/25 A, 25 AA, 29, 30, 9 R, 9 B**

FIG. 1 is a front-left-top perspective view of a barbecue cooker showing my new design;
 FIG. 2 is a front elevational view thereof;
 FIG. 3 is a rear elevational view thereof;
 FIG. 4 is a left elevational view thereof;
 FIG. 5 is a right elevational view thereof;
 FIG. 6 is a top plane view thereof;
 FIG. 7 is a bottom plane view thereof; and,
 FIG. 8 is a front elevational view of the barbecue cooker supported on a frame which is shown in broken lines for illustrative purposes only, which forms no part of the claimed design.

[56] References Cited

U.S. PATENT DOCUMENTS

D. 219,693	1/1971	Hahn	D7/337
D. 270,420	9/1983	Baugh	D7/337
D. 284,929	8/1986	Schlosser et al.	D7/332
D. 304,010	10/1989	Chuan	D7/332
D. 337,478	7/1993	Chuan	D7/337
D. 341,988	12/1993	Endres	D7/337
D. 352,865	11/1994	Pai	D7/337

1 Claim, 8 Drawing Sheets

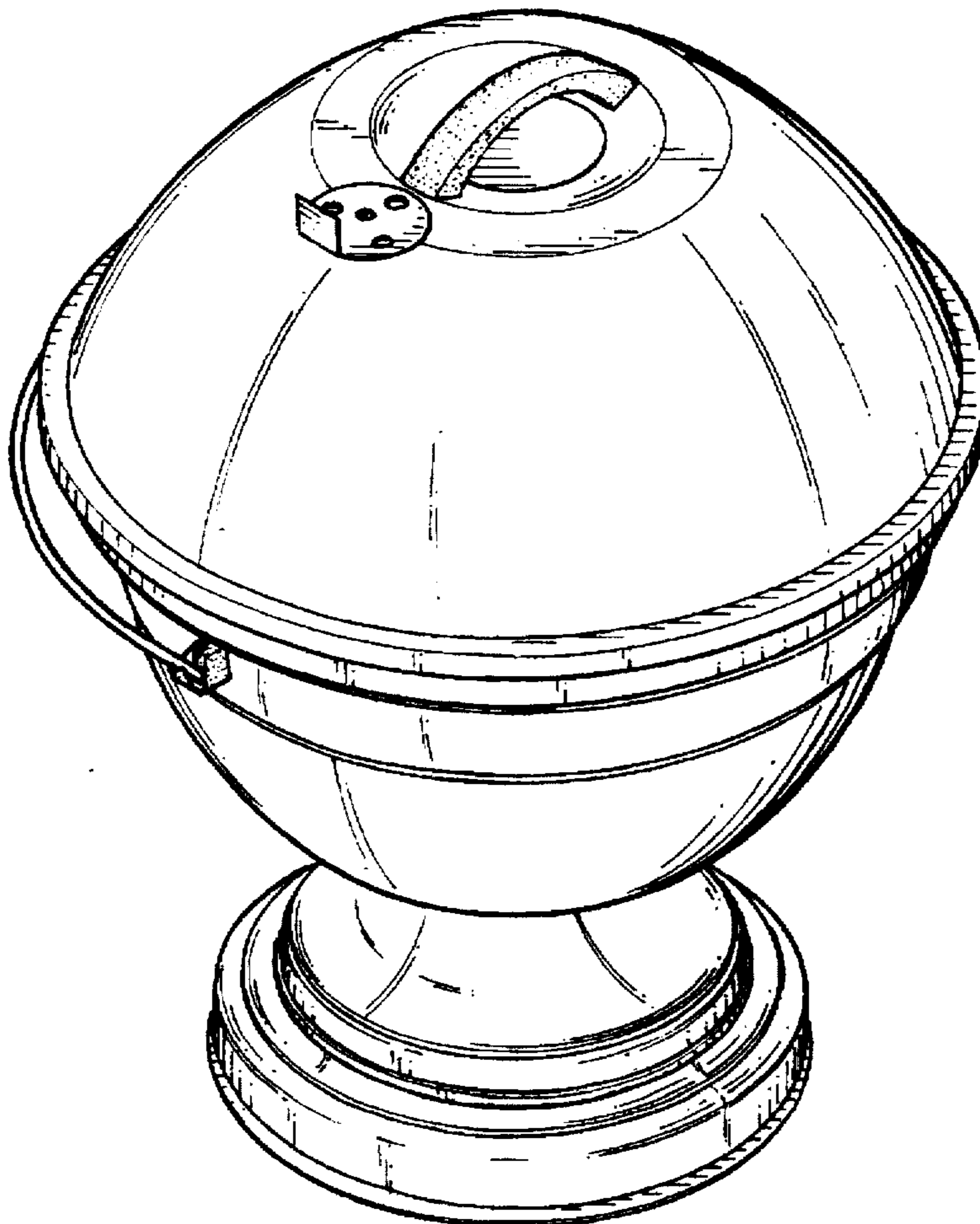

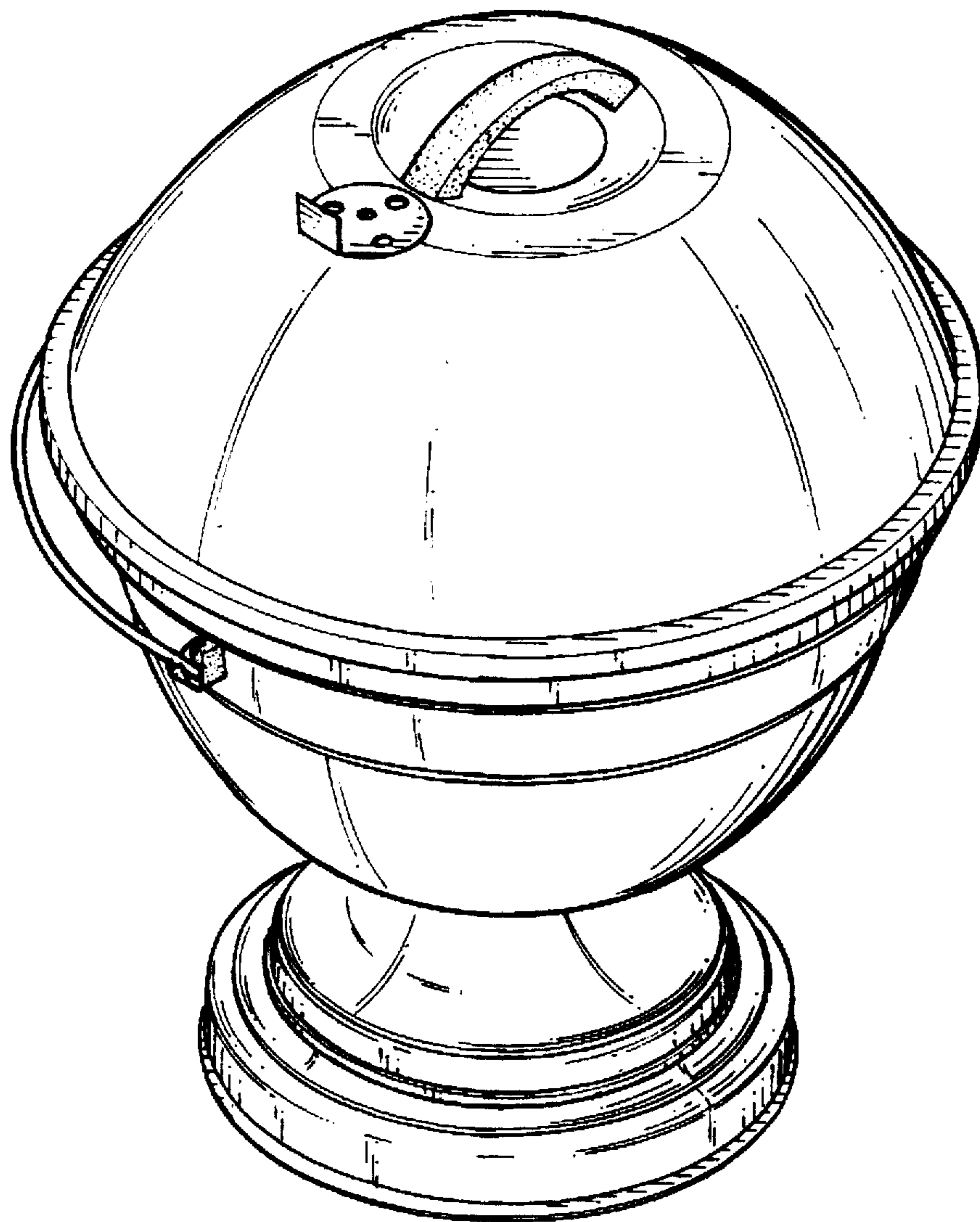

FIG. 1

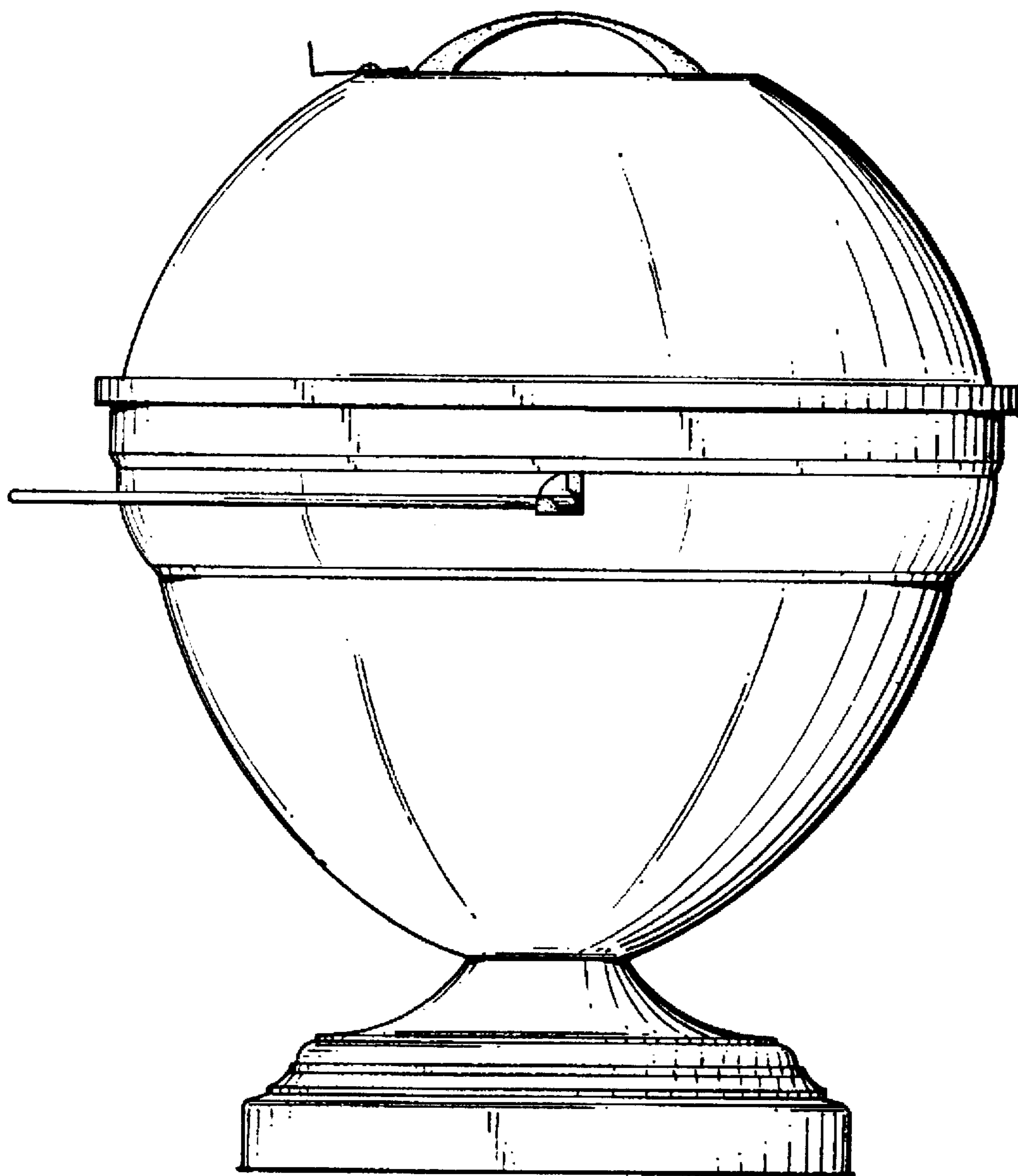

FIG. 2

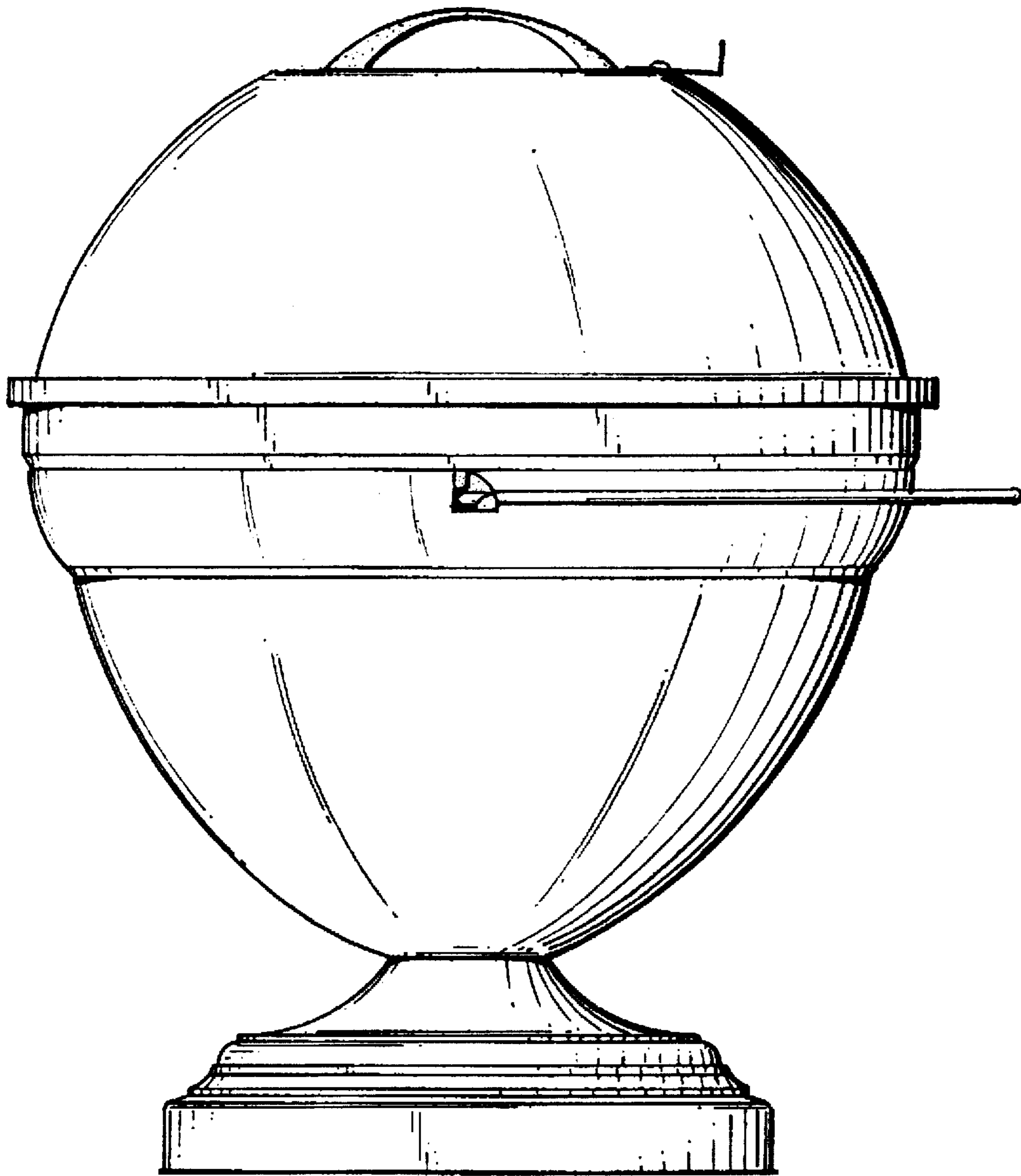

FIG. 3

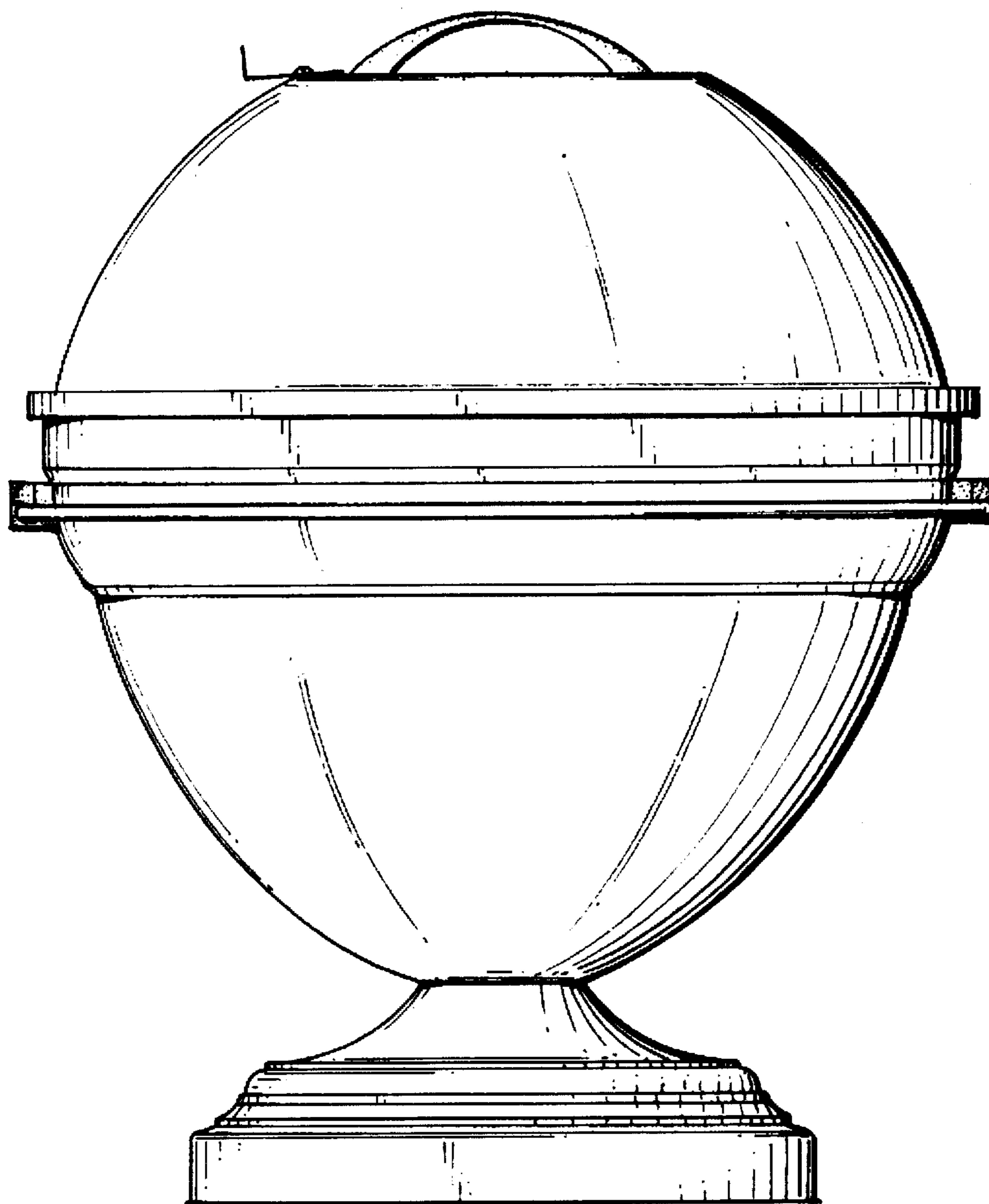

FIG. 4

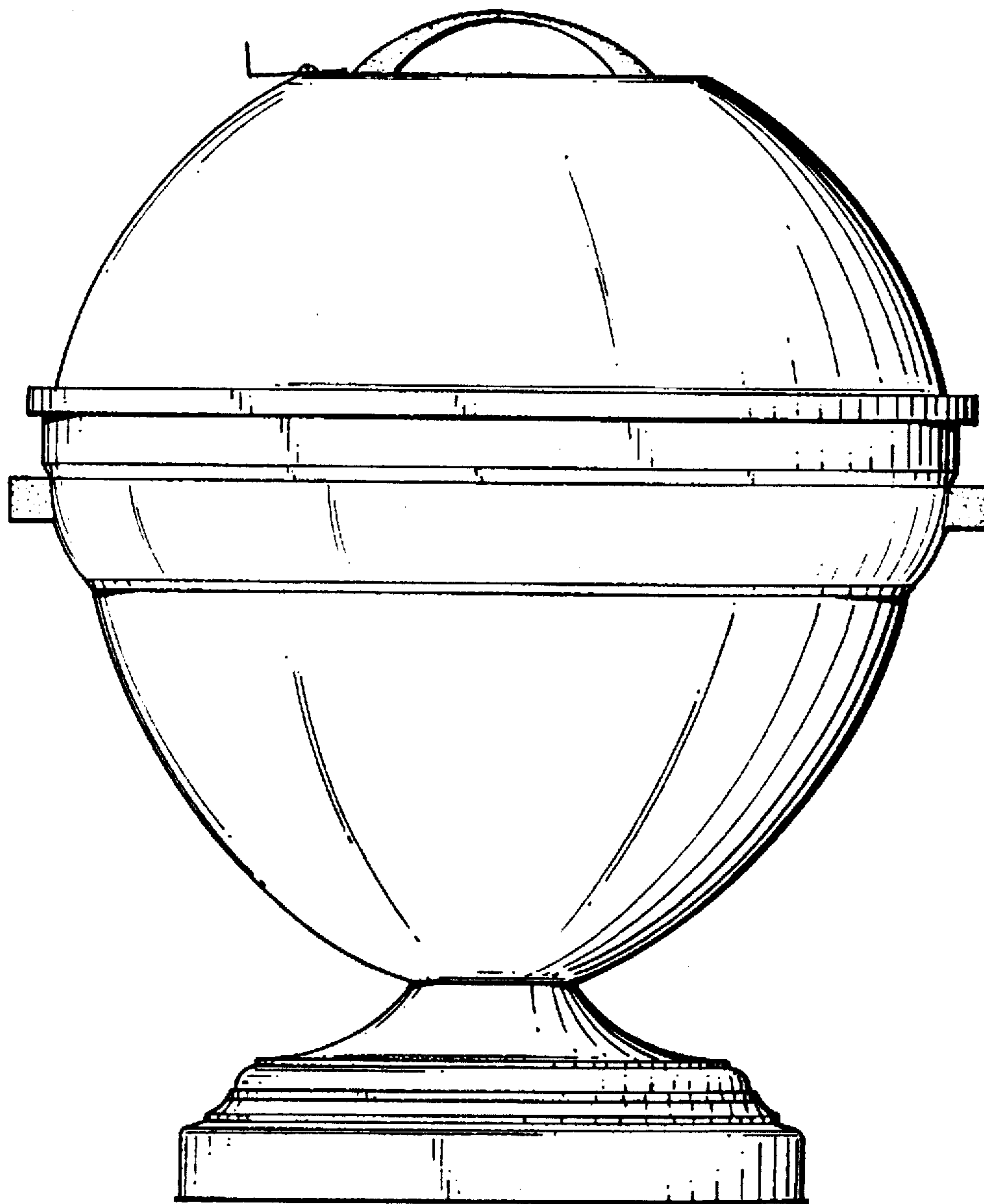

FIG. 5

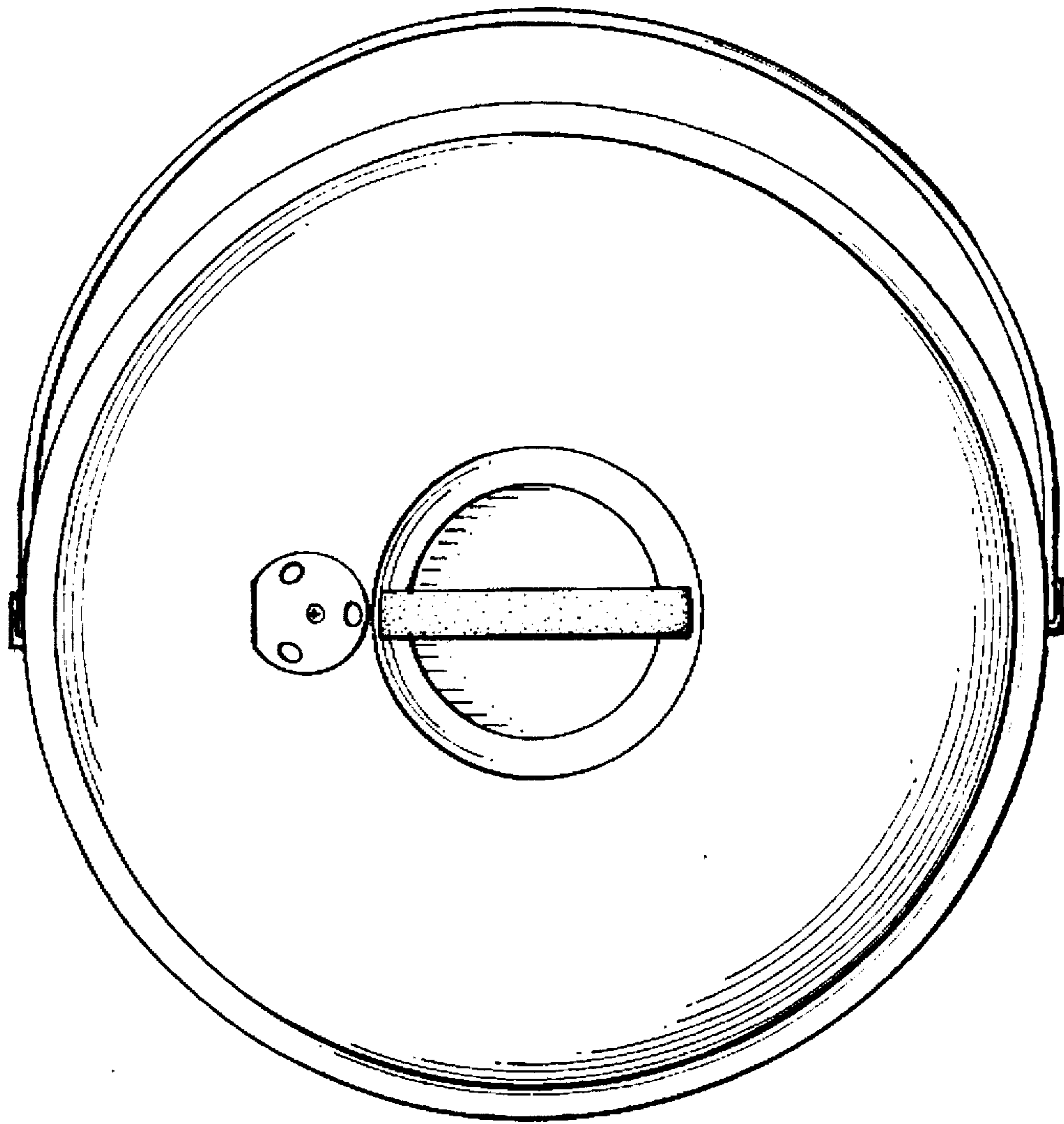

FIG. 6

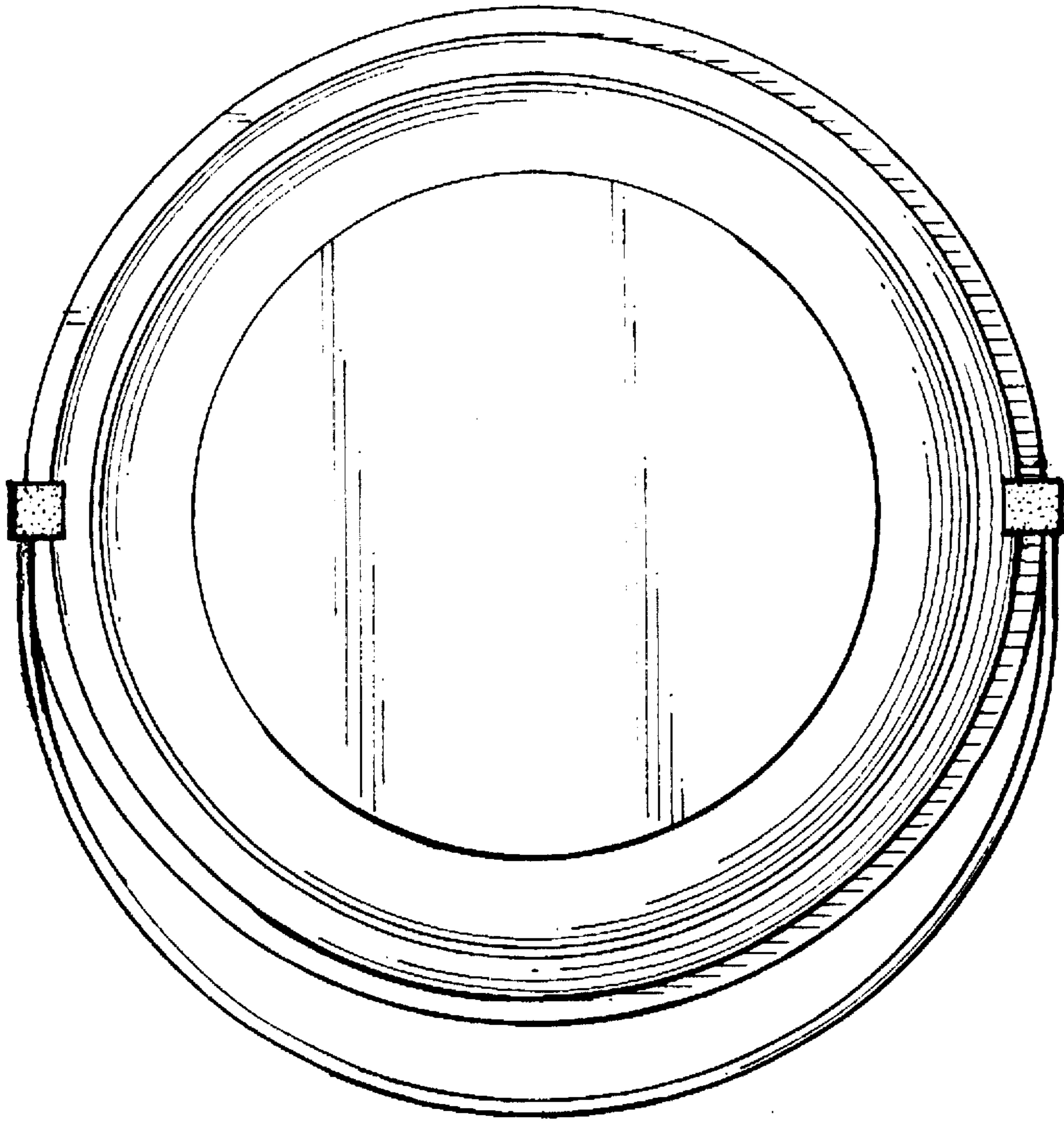

FIG. 7

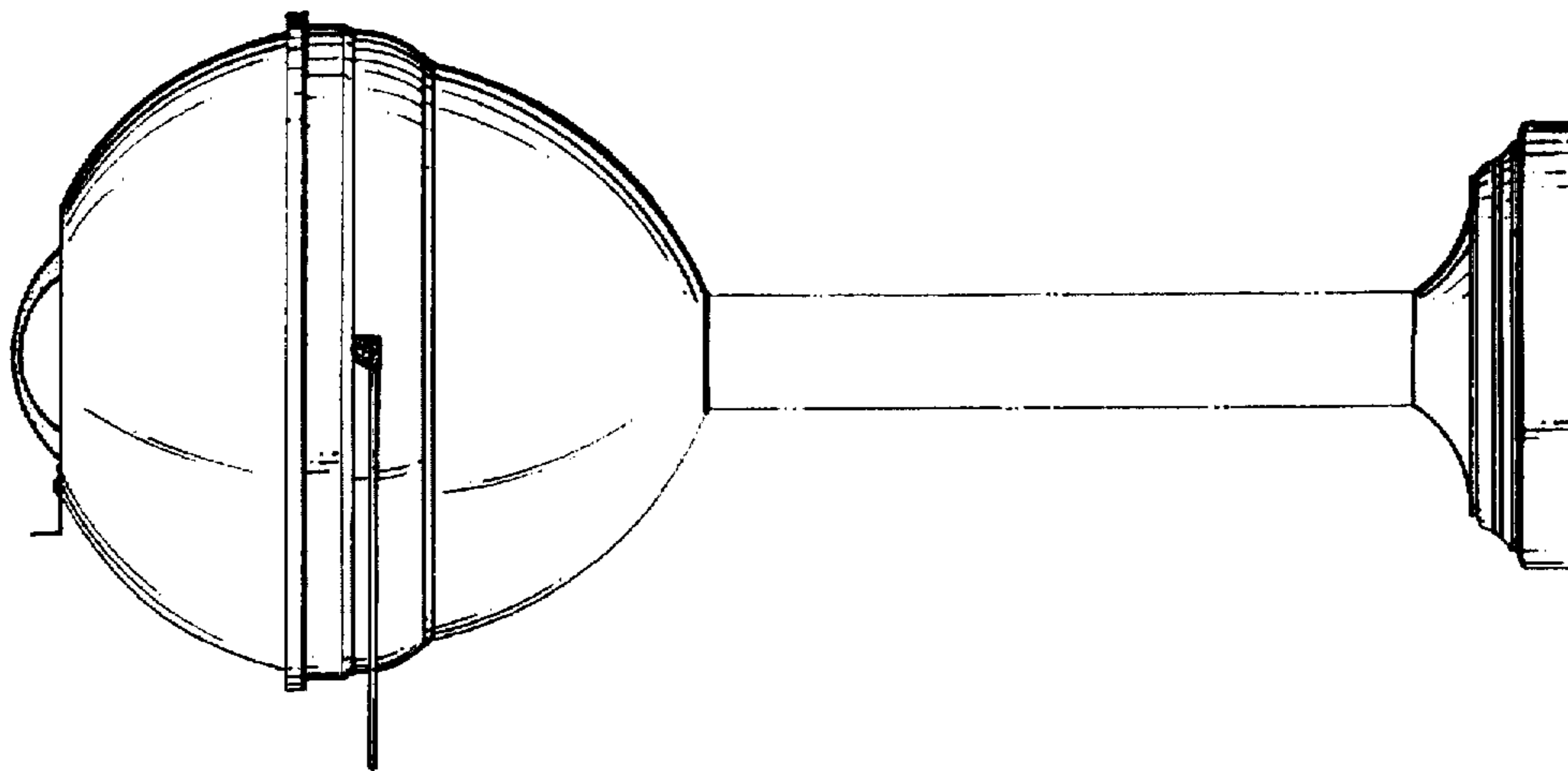

FIG. 8