



US00D383622S

**United States Patent** [19]  
**Thompson**

[11] **Patent Number: Des. 383,622**  
[45] **Date of Patent: \*\*Sep. 16, 1997**

[54] **MODULAR CABINETWORK**

D. 212,624 11/1968 Evans ..... D6/438  
D. 360,087 7/1995 Richards-Mouyos ..... D6/436

[76] **Inventor: Robert L. Thompson, 2219 Edenton Dr., Fort Wayne, Ind. 46804**

*Primary Examiner—Carmen H. Vales-Lado*  
*Attorney, Agent, or Firm—Roger M. Rickert*

[\*\*] **Term: 14 Years**

[57] **CLAIM**

[21] **Appl. No.: 52,039**

The ornamental design for modular cabinetwork, as shown and described.

[22] **Filed: Mar. 21, 1996**

**DESCRIPTION**

[51] **LOC (6) Cl. .... 06-04**

[52] **U.S. Cl. .... D6/438**

[58] **Field of Search ..... D6/432-448; 312/204, 312/257**

FIG. 1 is a perspective view of a modular cabinetwork showing my new design;  
FIG. 2 is a front elevation view thereof;  
FIG. 3 is a rear elevation view thereof;  
FIG. 4 is a left side elevation view thereof;  
FIG. 5 is a right side elevation view thereof;  
FIG. 6 is a top view thereof;  
FIG. 7 is a bottom view thereof;  
FIG. 8 is a perspective view of a modified form of the modular cabinetwork shown in FIG. 1, the opposite side being identical thereto;  
FIG. 9 is a top plan view thereof; and,  
FIG. 10 is a bottom plan view thereof.

[56] **References Cited**

**U.S. PATENT DOCUMENTS**

D. 51,008	7/1917	Armstrong	.....	D6/436
D. 57,061	2/1921	Peck	.....	D6/438
D. 97,616	11/1935	Rockola	.....	D6/438
D. 113,318	2/1939	Barnett	.....	D6/438 X
D. 123,934	12/1940	Doner	.....	D6/438
D. 150,824	9/1948	Buckner	.....	D6/437
D. 192,689	5/1962	Hess	.....	D6/438
D. 210,334	2/1968	Leath	.....	D6/438

**1 Claim, 7 Drawing Sheets**

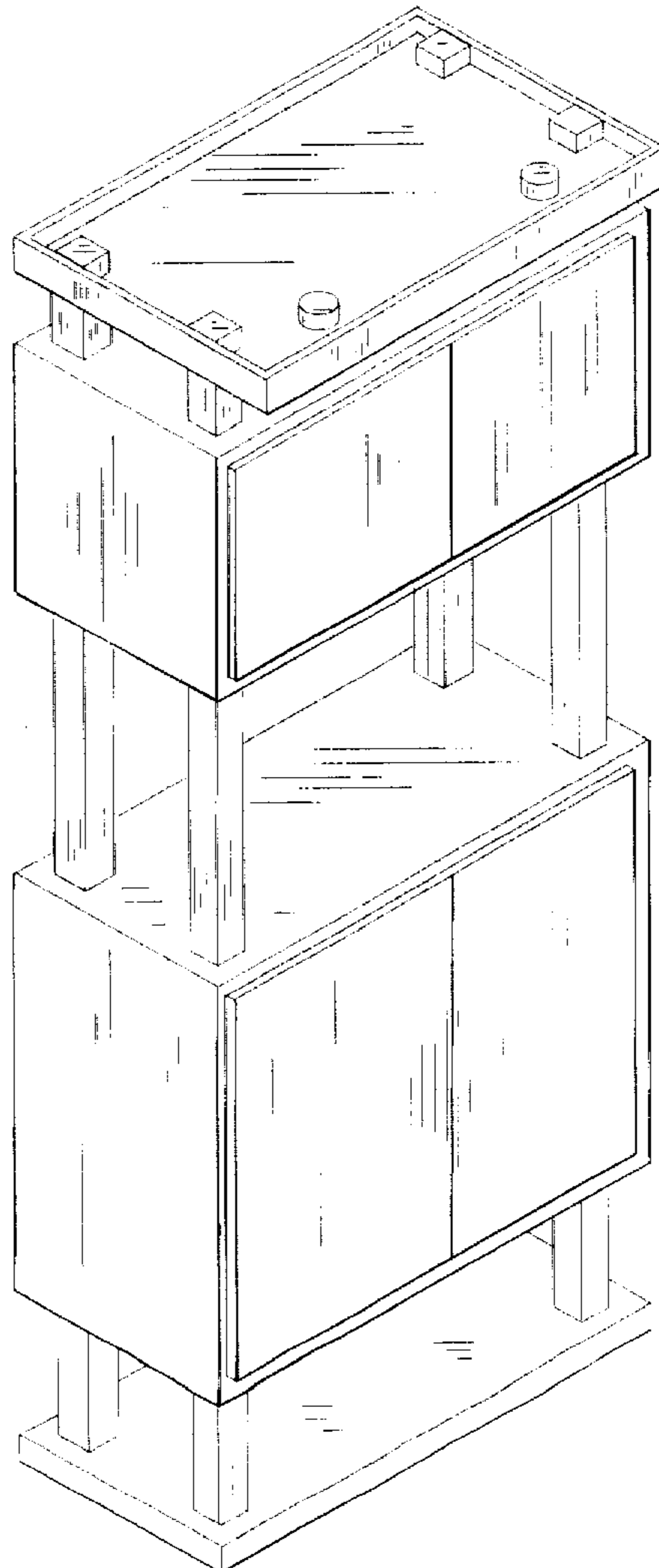

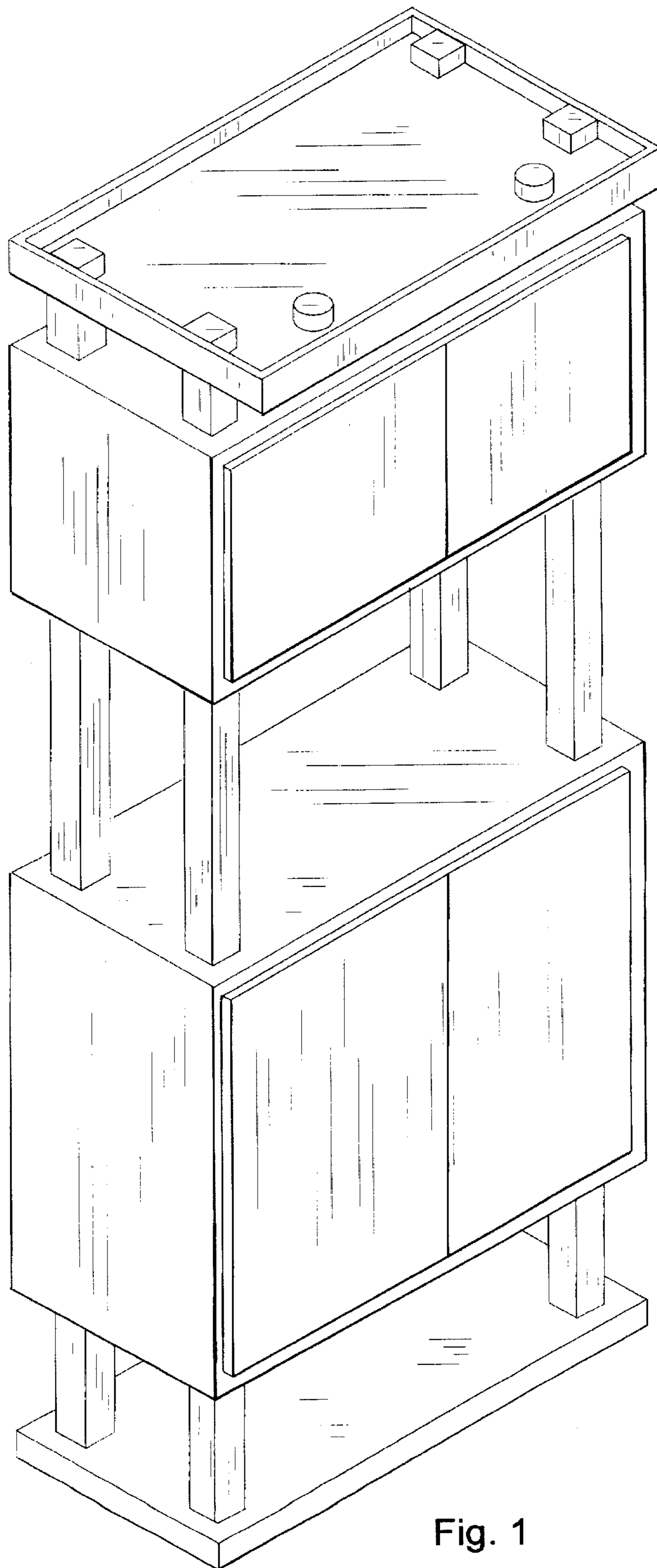

Fig. 1

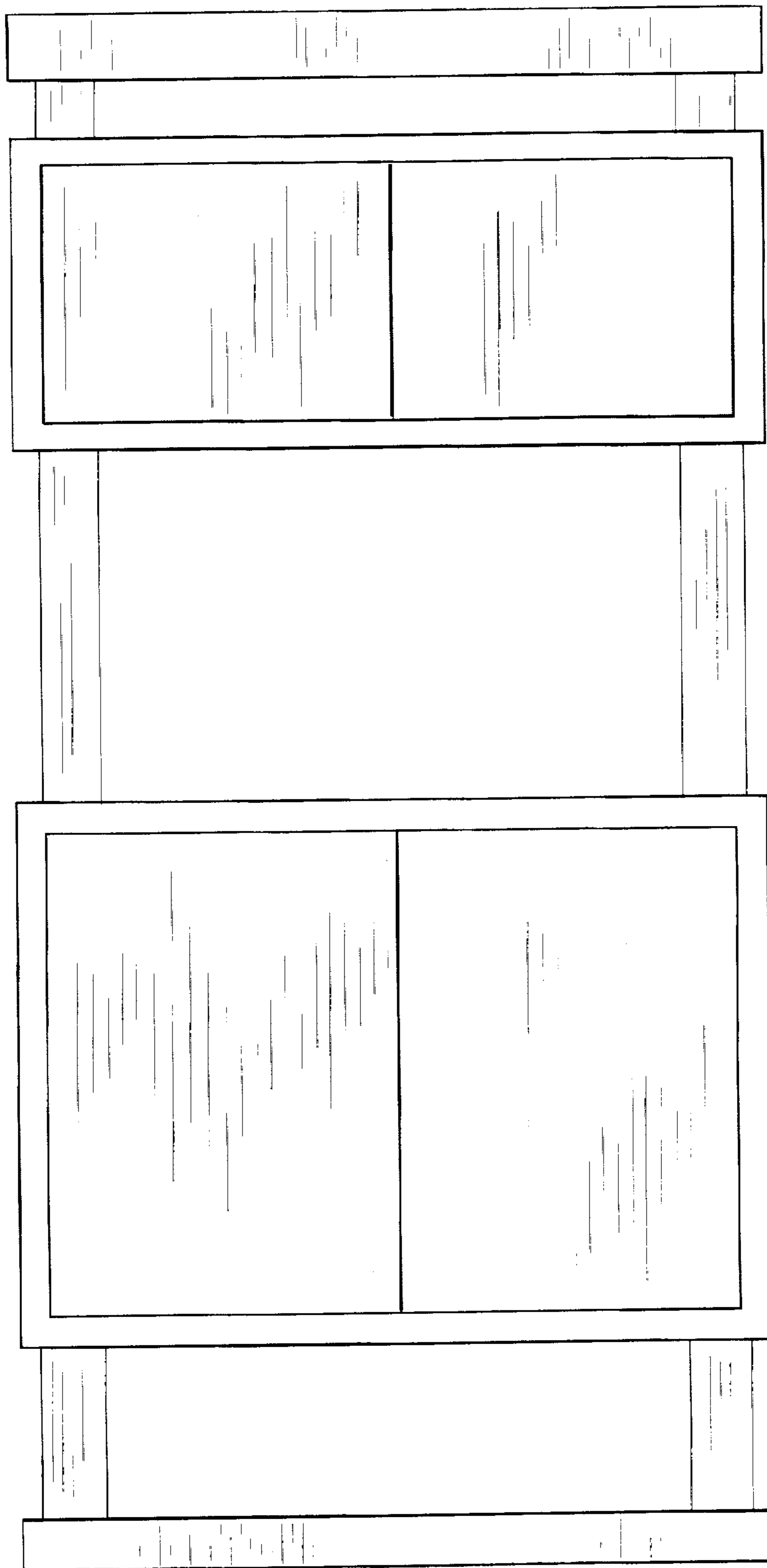

Fig. 2

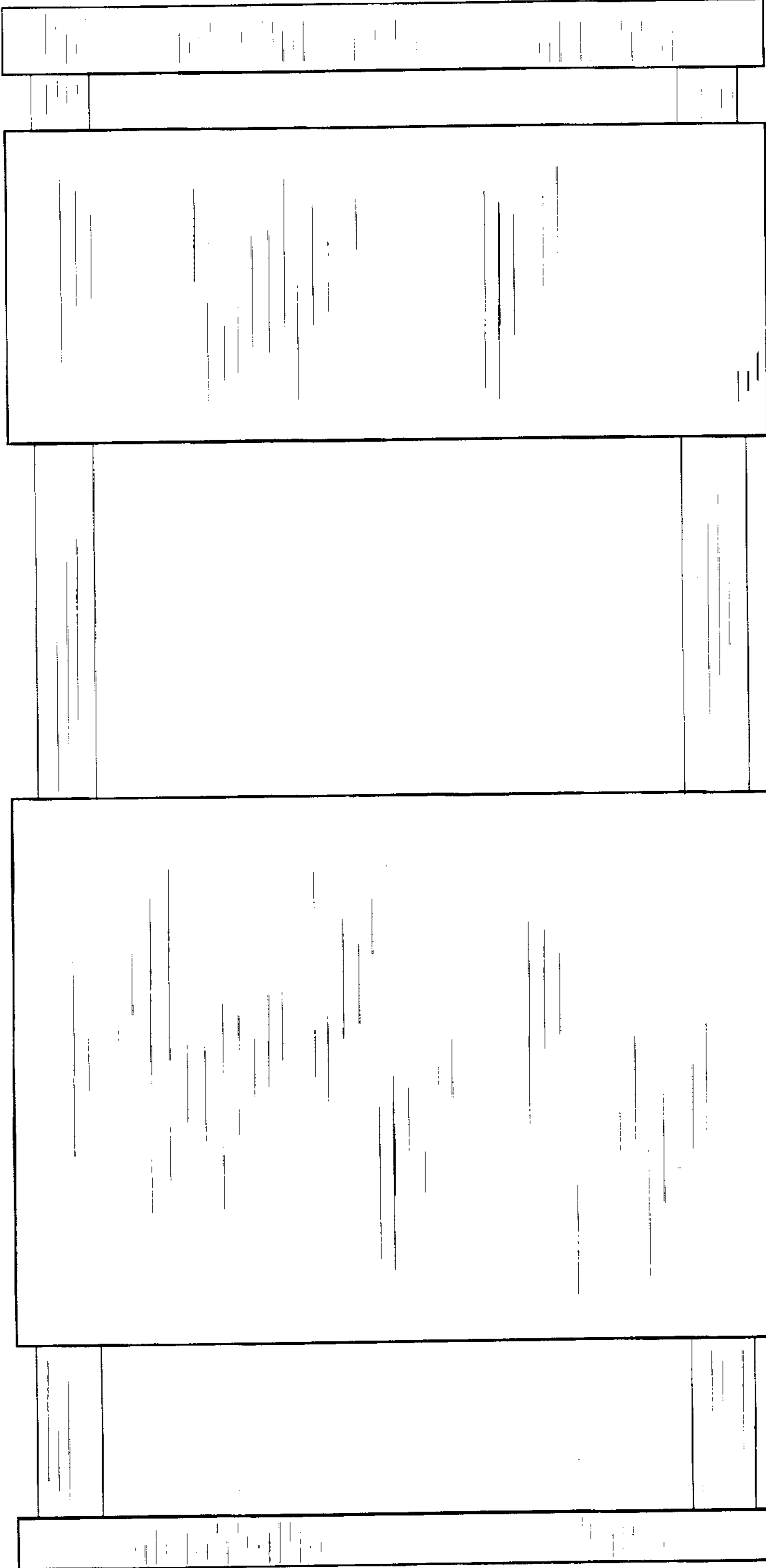

Fig. 3

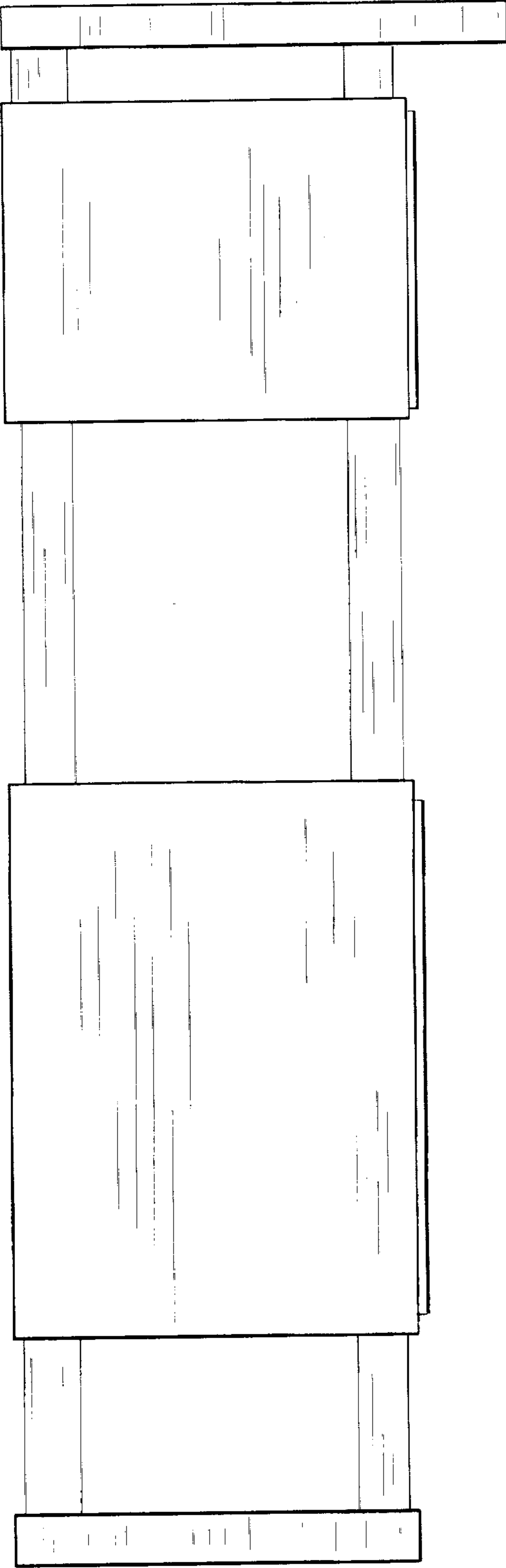

Fig. 4

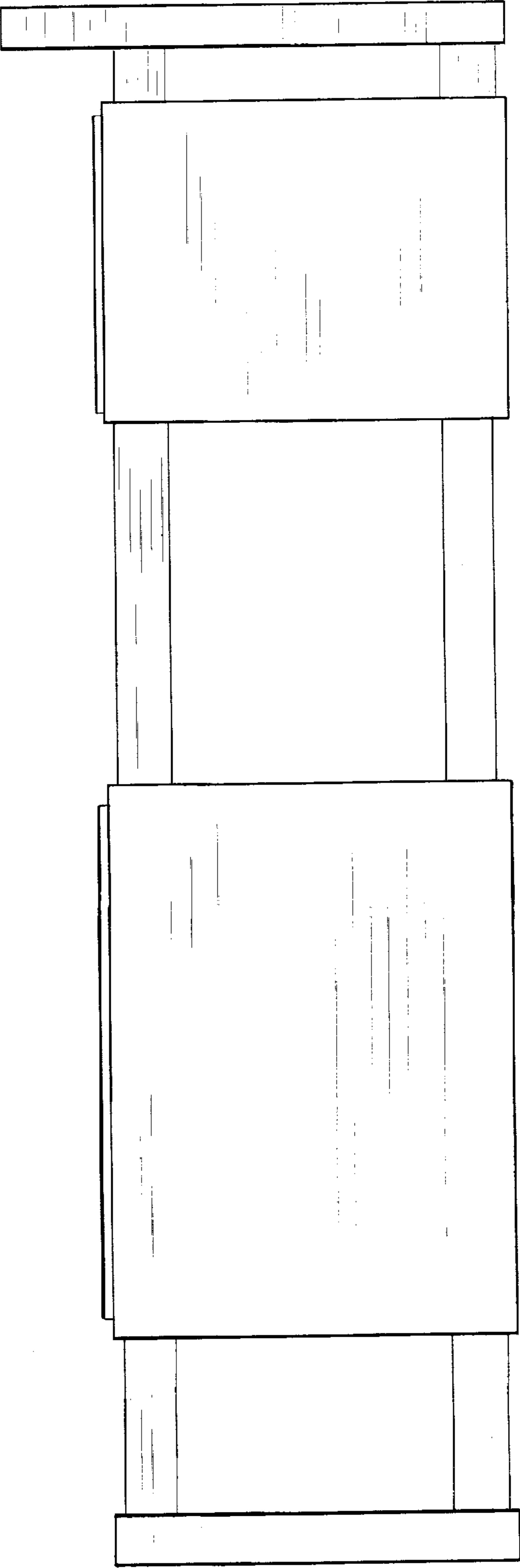

Fig. 5

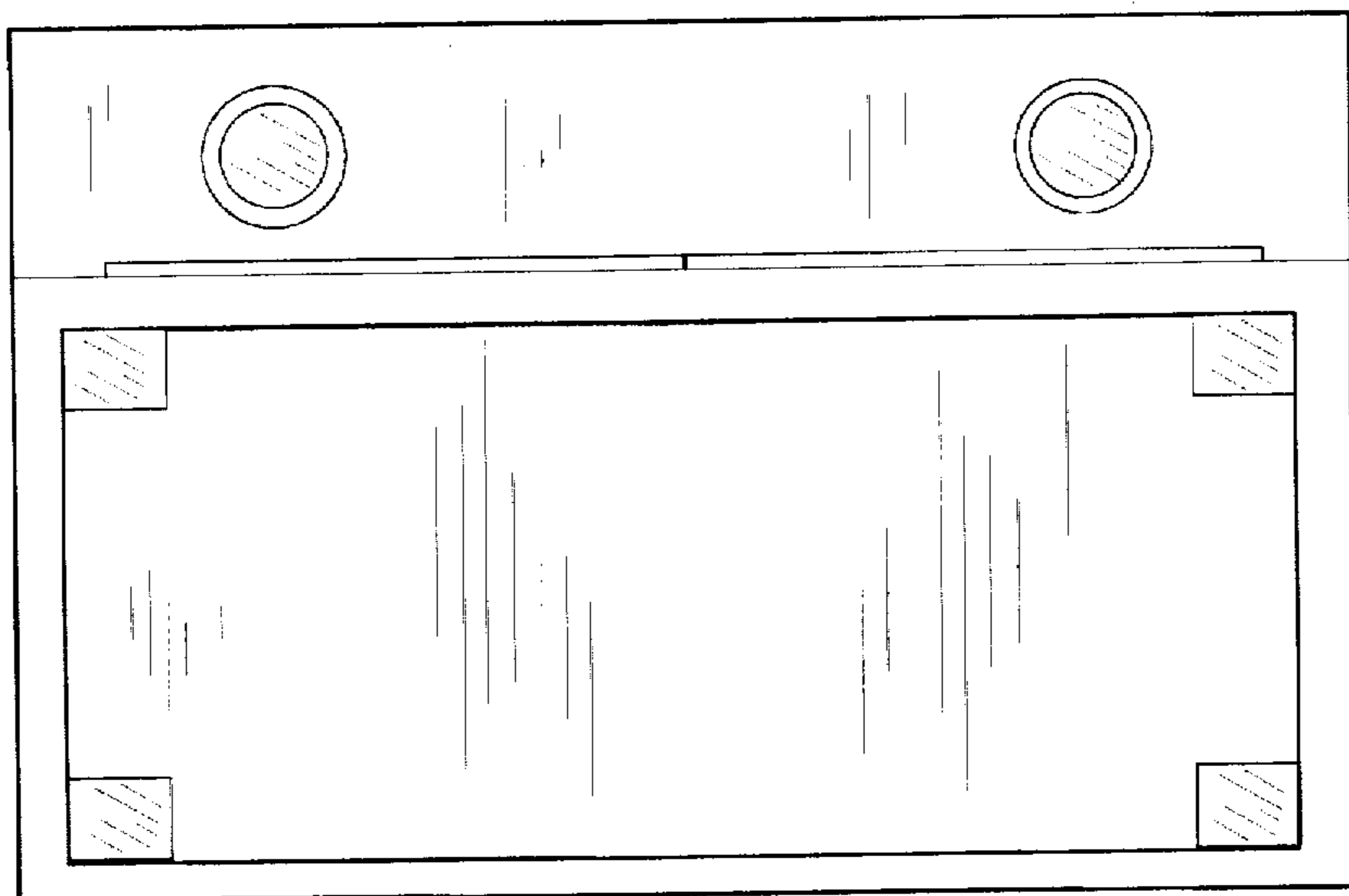

Fig. 7

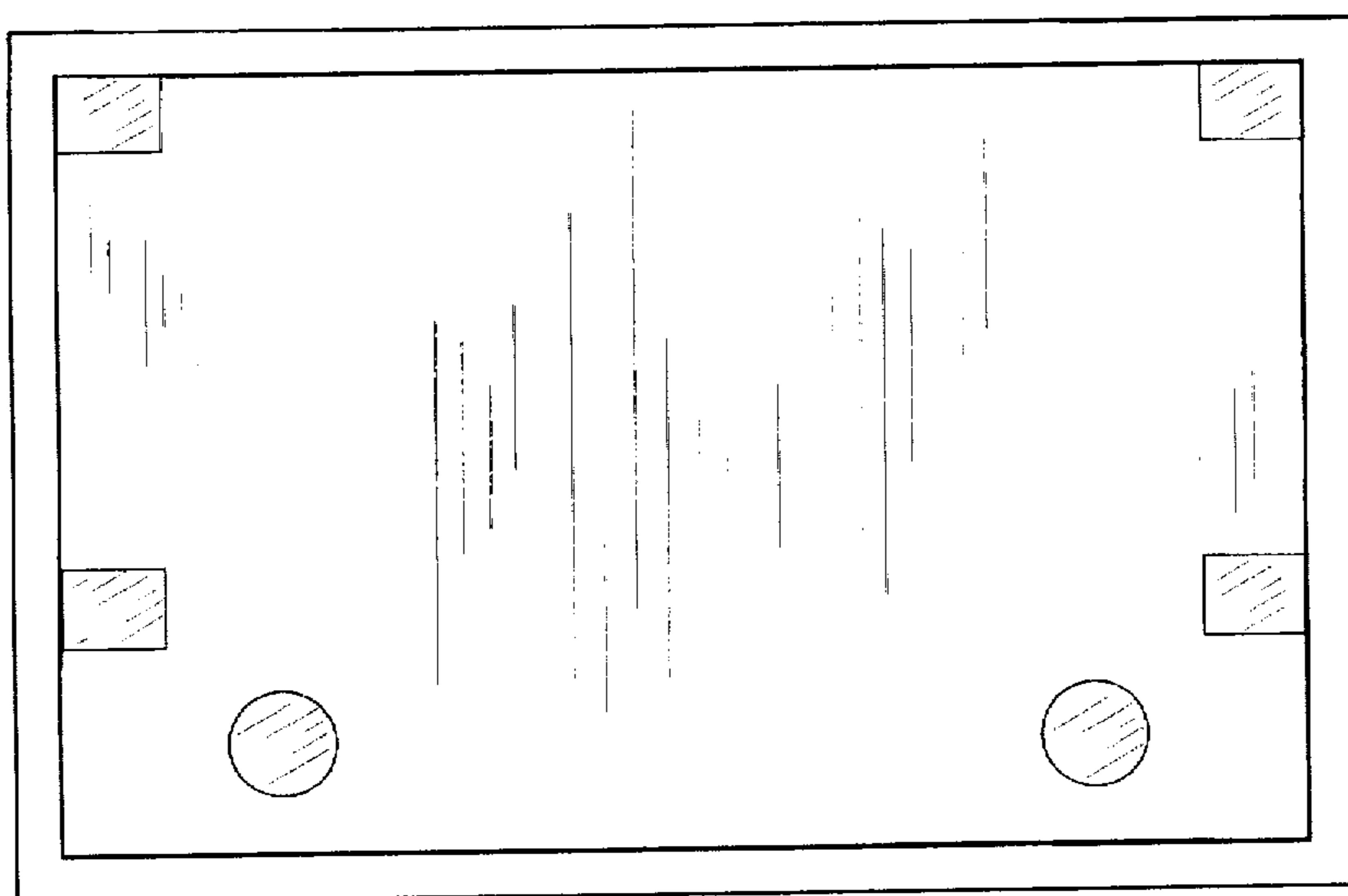

Fig. 6

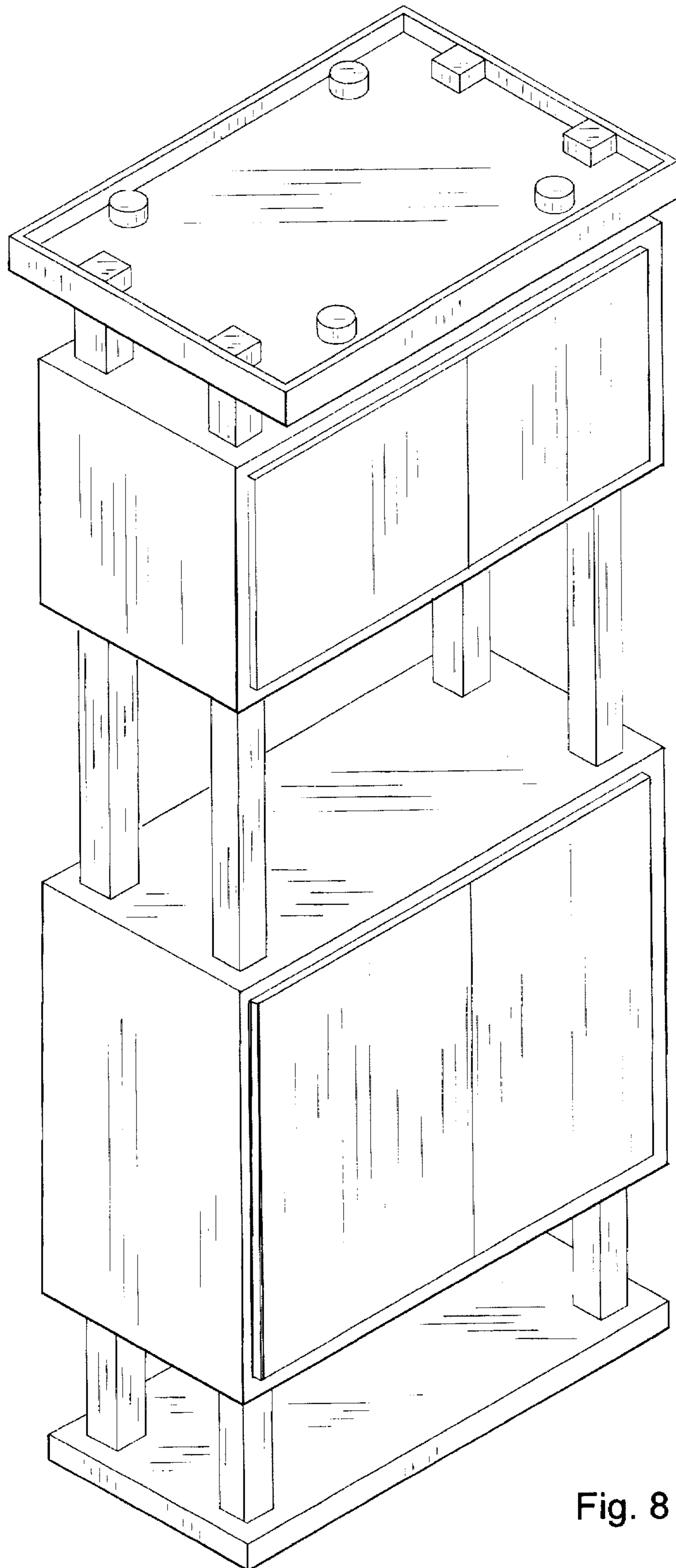

Fig. 8

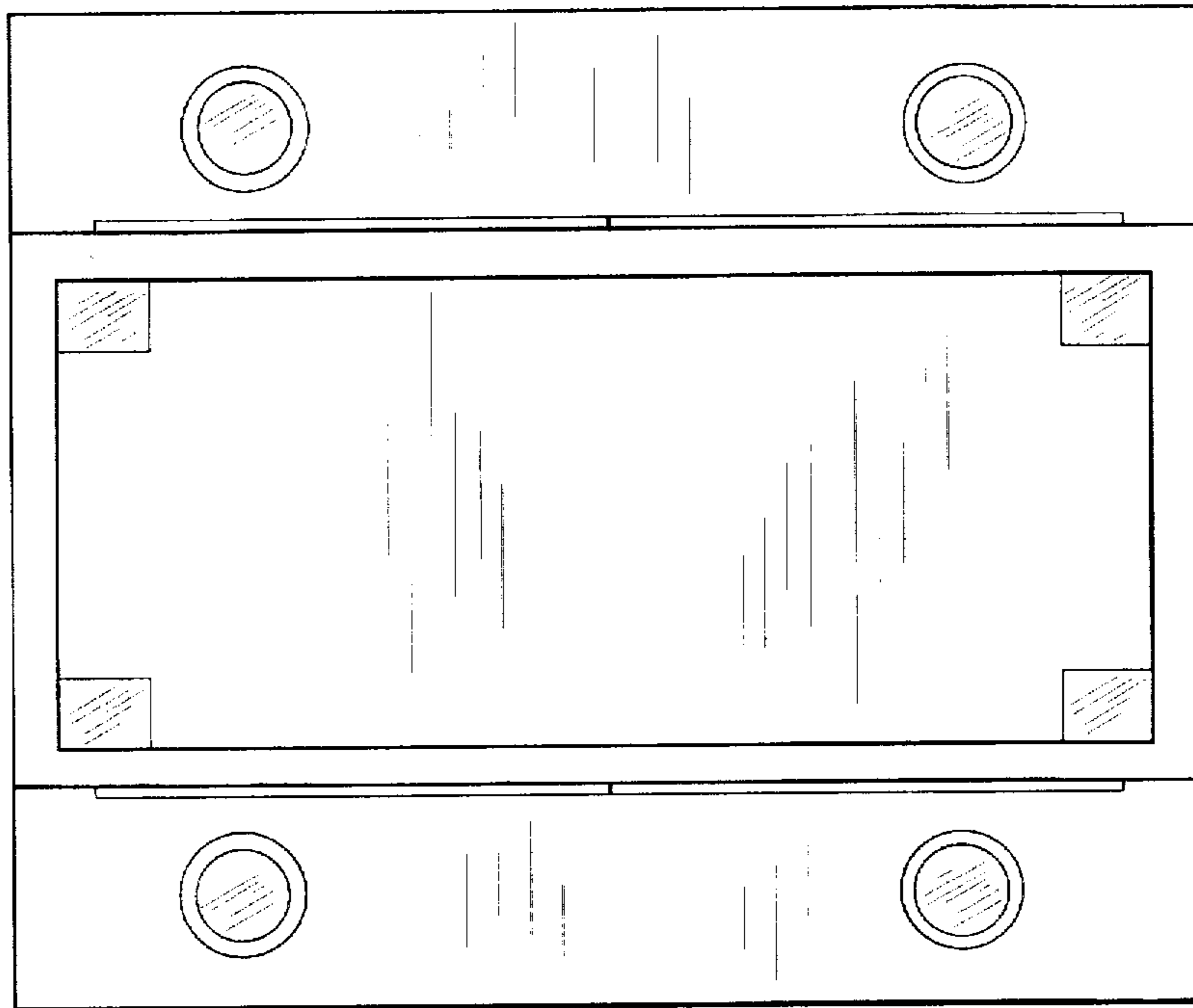

Fig. 10

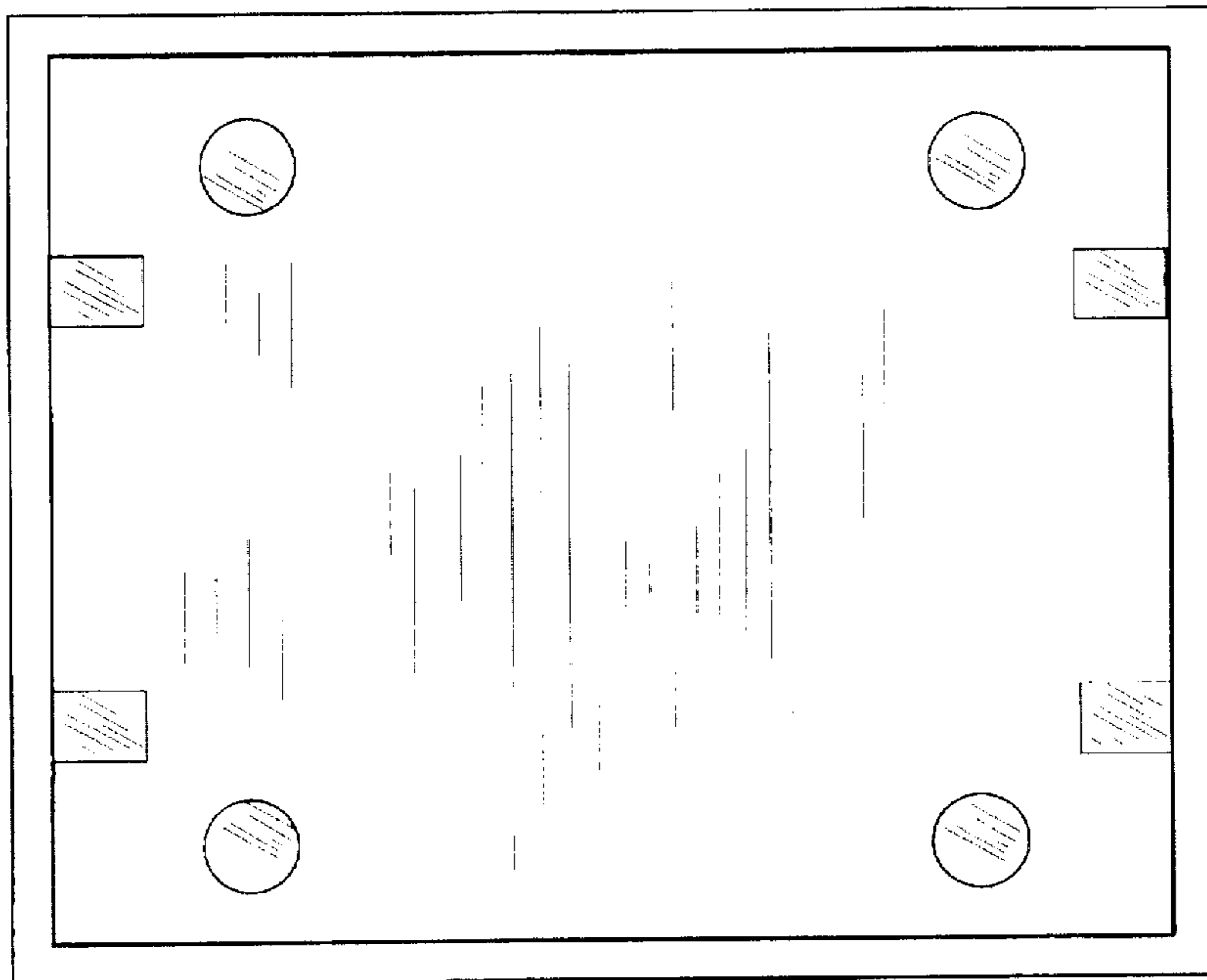

Fig. 9