



US00D383488S

United States Patent [19]
Sasaki

[11] **Patent Number:** **Des. 383,488**

[45] **Date of Patent:** ****Sep. 9, 1997**

[54] **INK CARTRIDGE FOR INK JET PRINTER**

[75] **Inventor:** **Toyonori Sasaki, Anjo, Japan**

[73] **Assignee:** **Brother Kogyo Kabushiki Kaisha, Nagoya, Japan**

[**] **Term:** **14 Years**

[21] **Appl. No.:** **44,359**

[22] **Filed:** **Sep. 22, 1995**

[30] **Foreign Application Priority Data**

Mar. 30, 1995 [JP] Japan 7-9070

[51] **LOC (6) Cl.** **18-02**

[52] **U.S. Cl.** **D18/56**

[58] **Field of Search** **D18/56; 347/86-87; 101/348**

[56] **References Cited**

U.S. PATENT DOCUMENTS

D. 356,110	3/1995	Tokuda et al.	D18/56
D. 359,755	6/1995	Tokuda et al.	D18/56
D. 361,591	8/1995	Tokuda et al.	D18/56
D. 363,736	10/1995	Ujita et al.	D18/56
D. 367,884	3/1996	Taneya et al.	D18/56
4,920,360	4/1990	Terasawa et al.	347/87

Primary Examiner—Cathy Anne MacCormac
Attorney, Agent, or Firm—Oliff & Berridge

[57] **CLAIM**

The ornamental design for an ink cartridge for ink jet printer, as shown and described.

DESCRIPTION

FIG. 1 is a top plan view of an ink cartridge for an ink jet printer;

FIG. 2 is a front view of FIG. 1;

FIG. 3 is a bottom plan view of FIG. 1;

FIG. 4 is a left side view of FIG. 1;

FIG. 5 is a right side view of FIG. 1;

FIG. 6 is a rear view of FIG. 1;

FIG. 7 is a perspective view of FIG. 1;

FIG. 8 is a top plan view of a second embodiment of FIG. 1;

FIG. 9 is a front view of FIG. 8;

FIG. 10 is a bottom plan view of FIG. 8;

FIG. 11 is a left side view of FIG. 8;

FIG. 12 is a right side view of FIG. 8;

FIG. 13 is a rear view of FIG. 8, and,

FIG. 14 is a perspective view of FIG. 8.

1 Claim, 4 Drawing Sheets

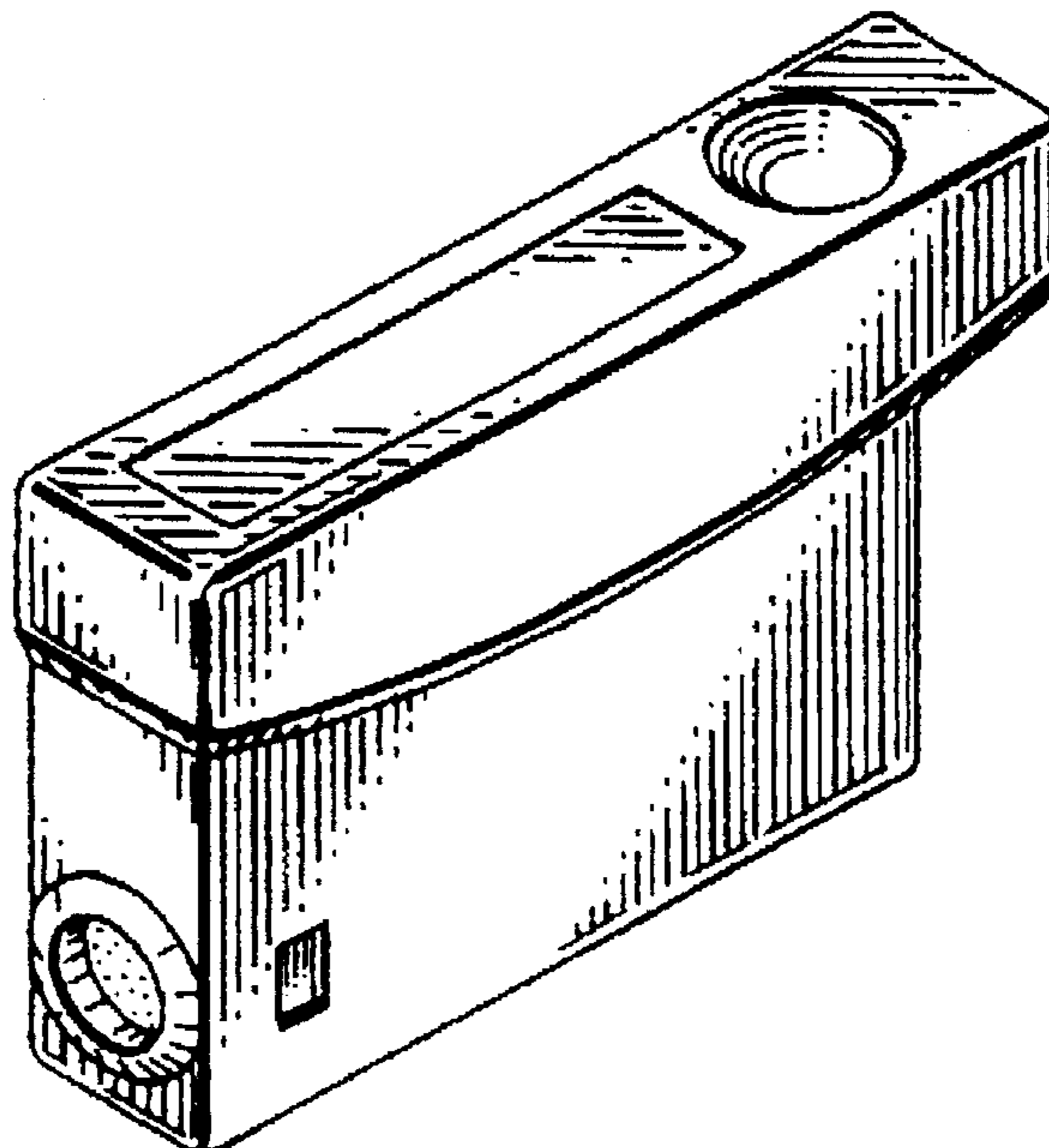
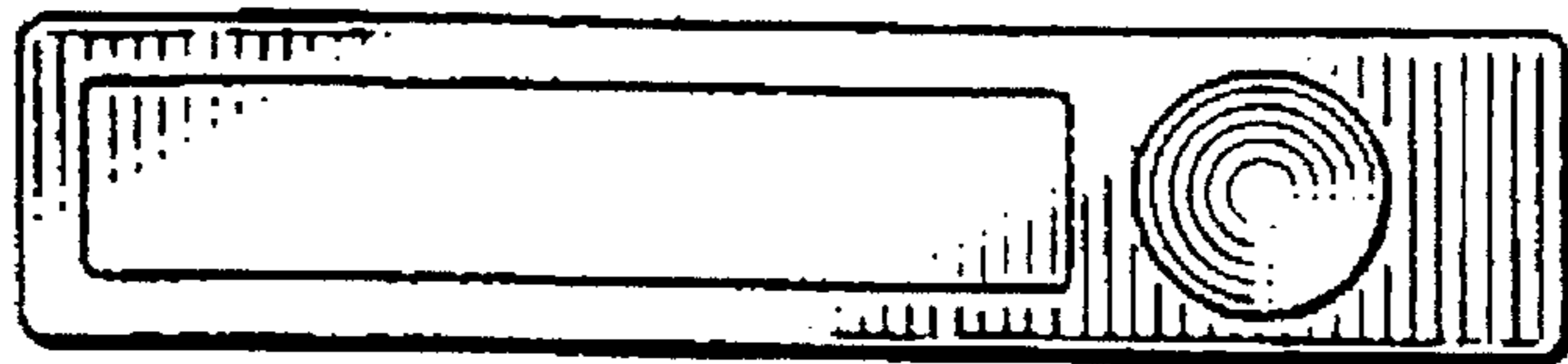

FIG.1

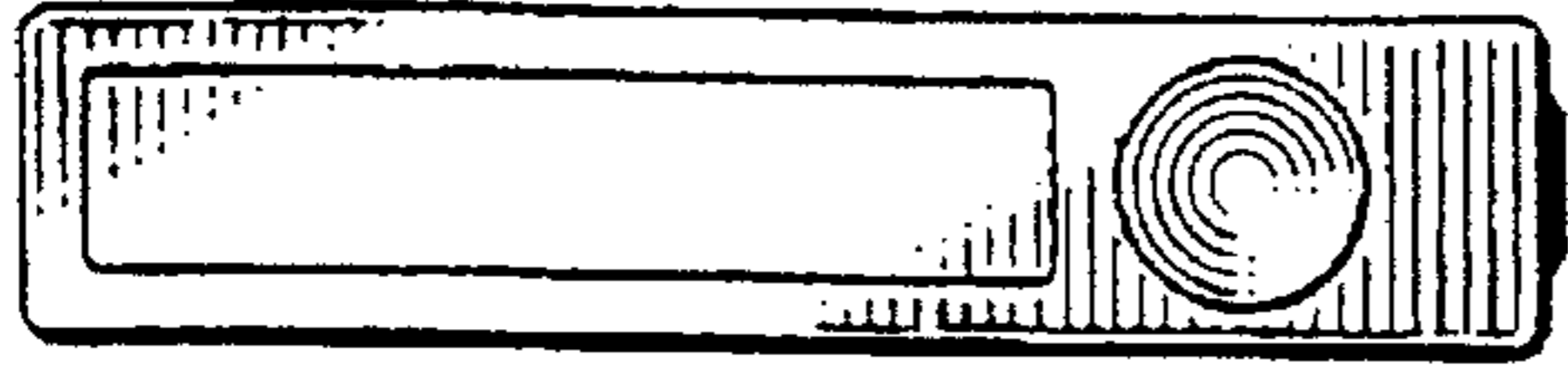

FIG.4



FIG.2

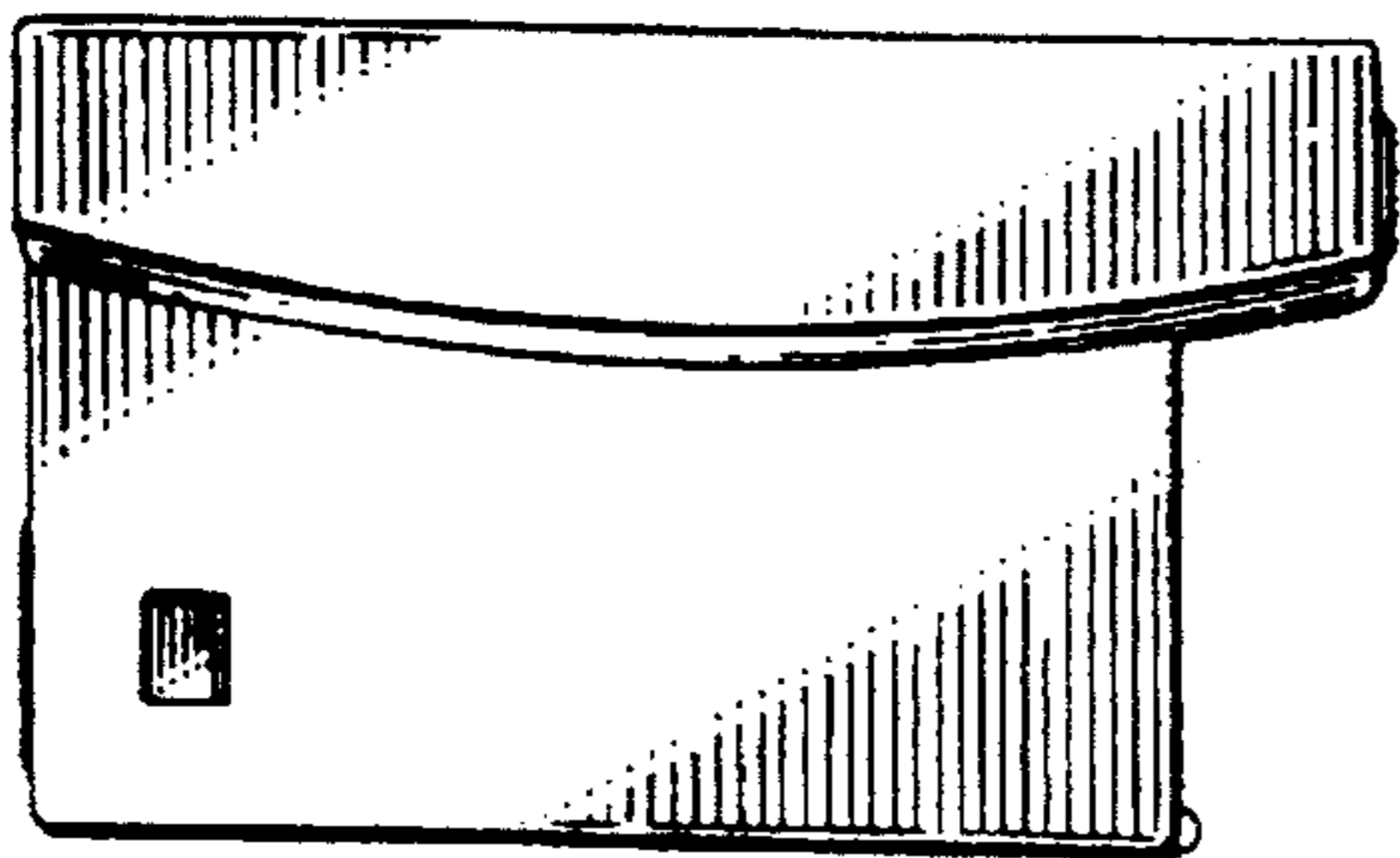

FIG.5



FIG.3

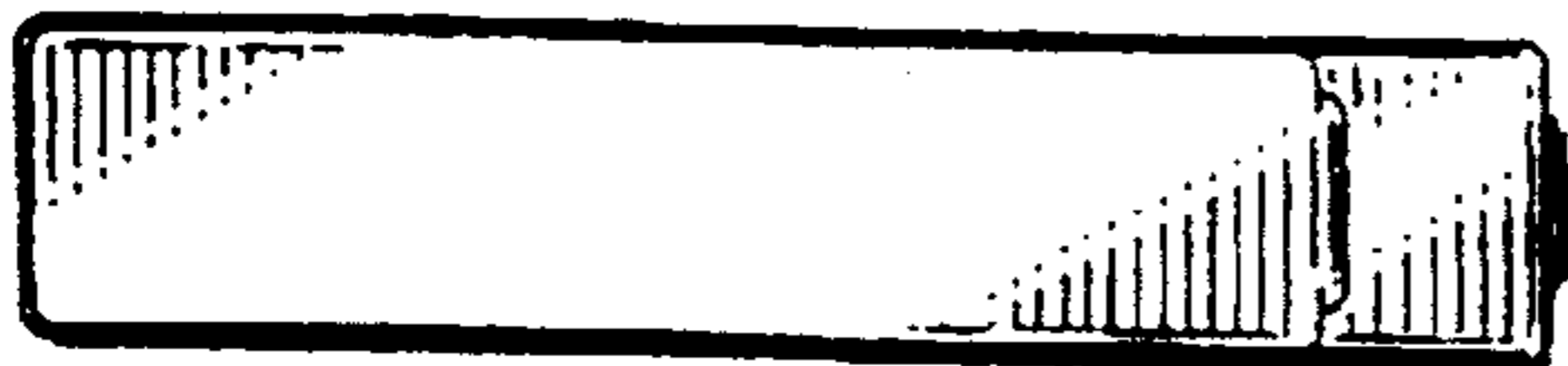

FIG.6

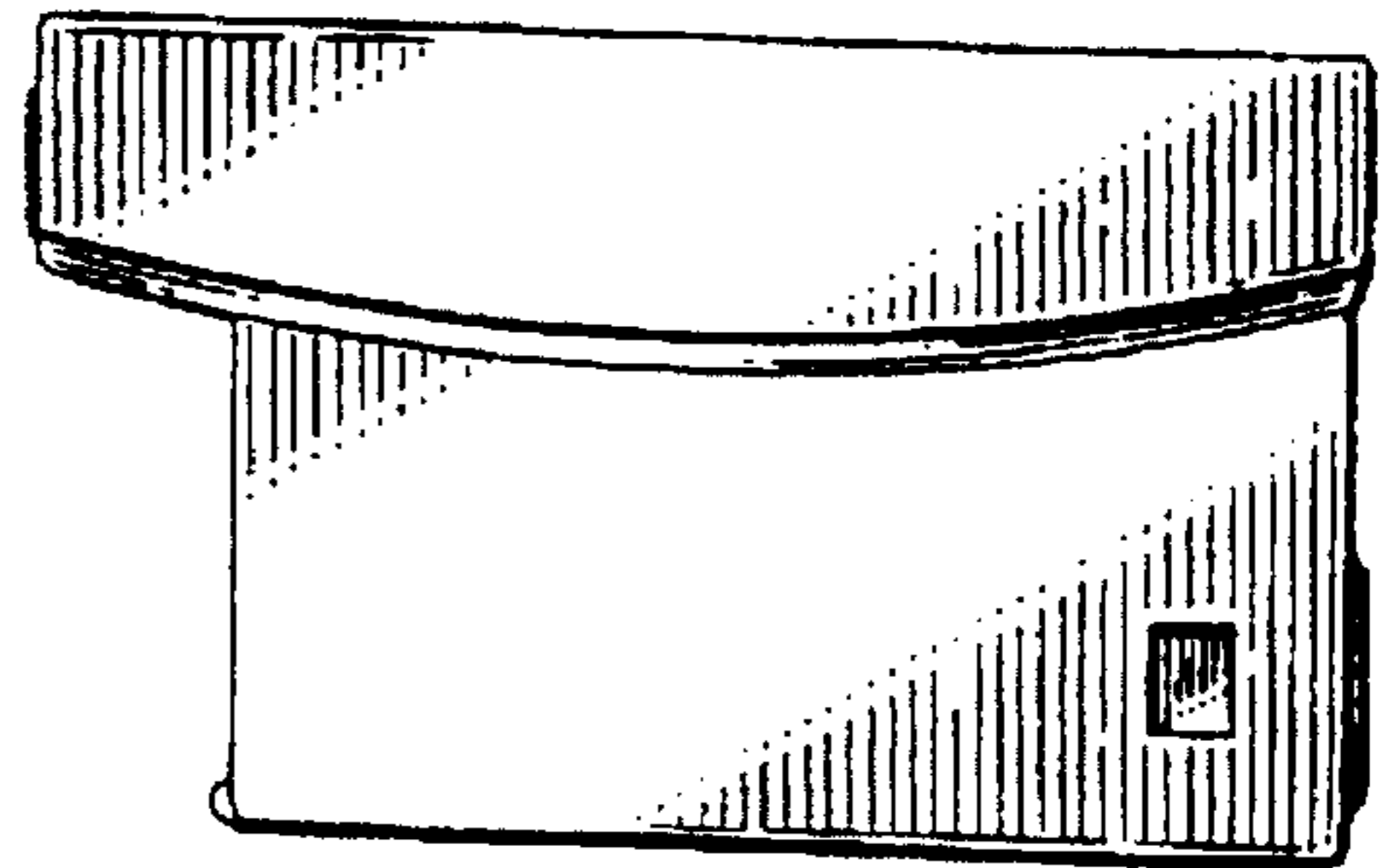

FIG. 7

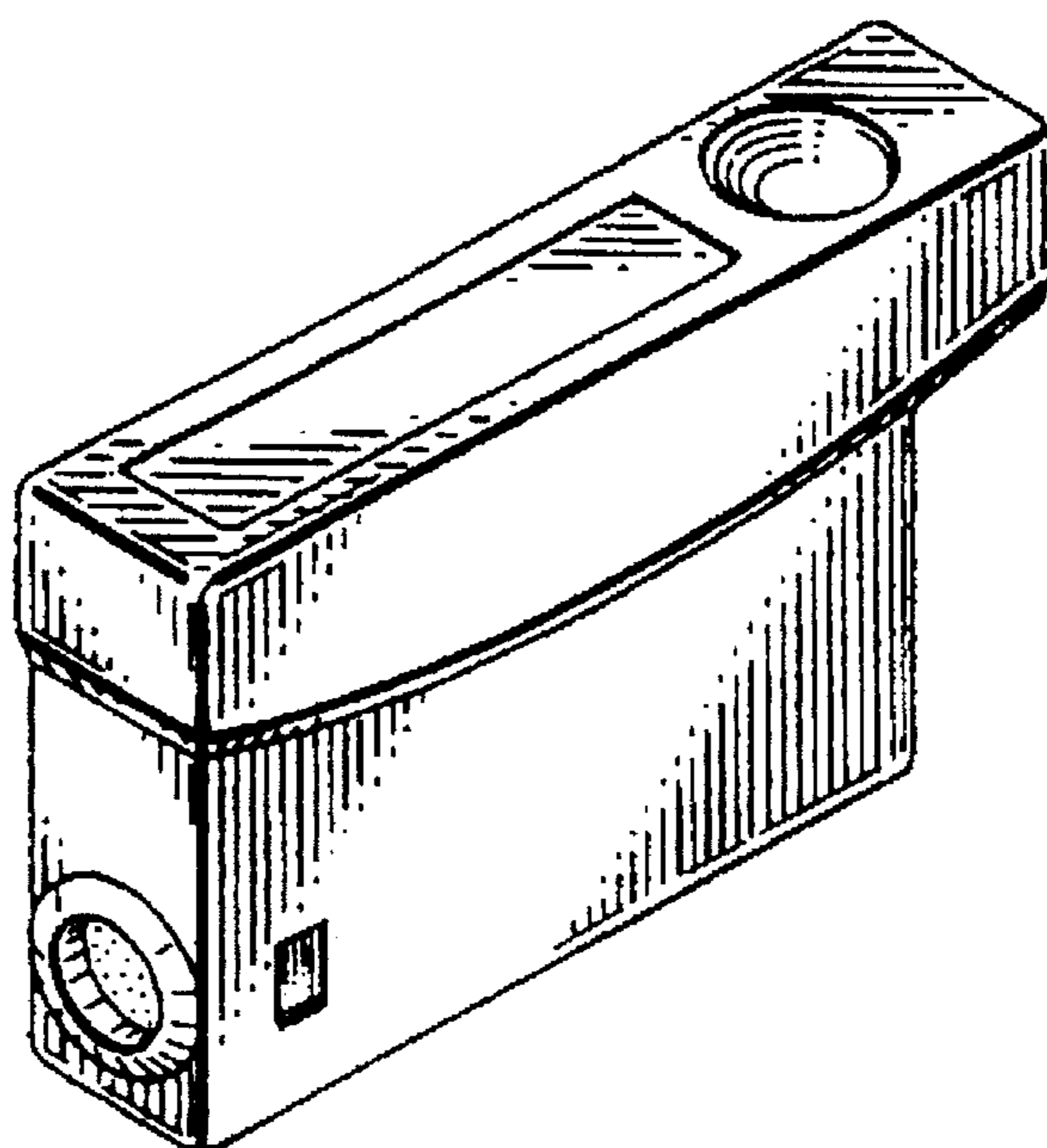

FIG. 8

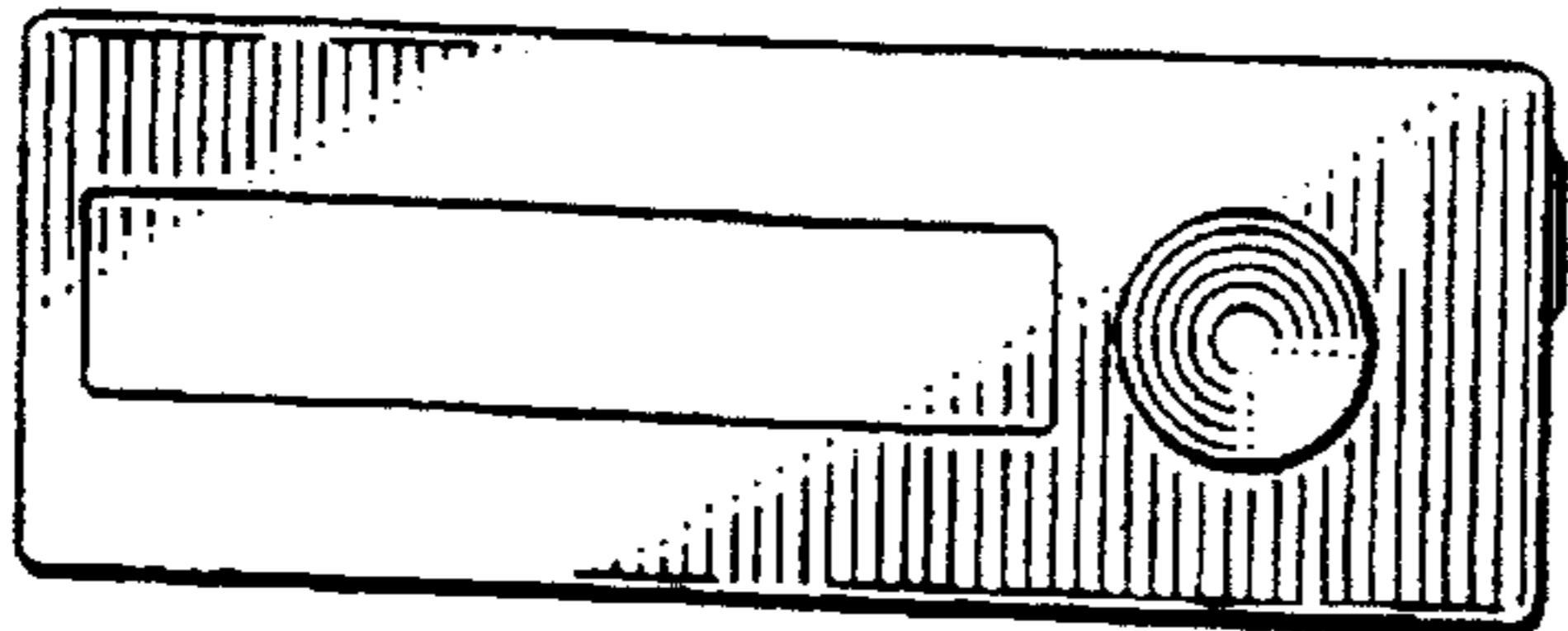

FIG. 11

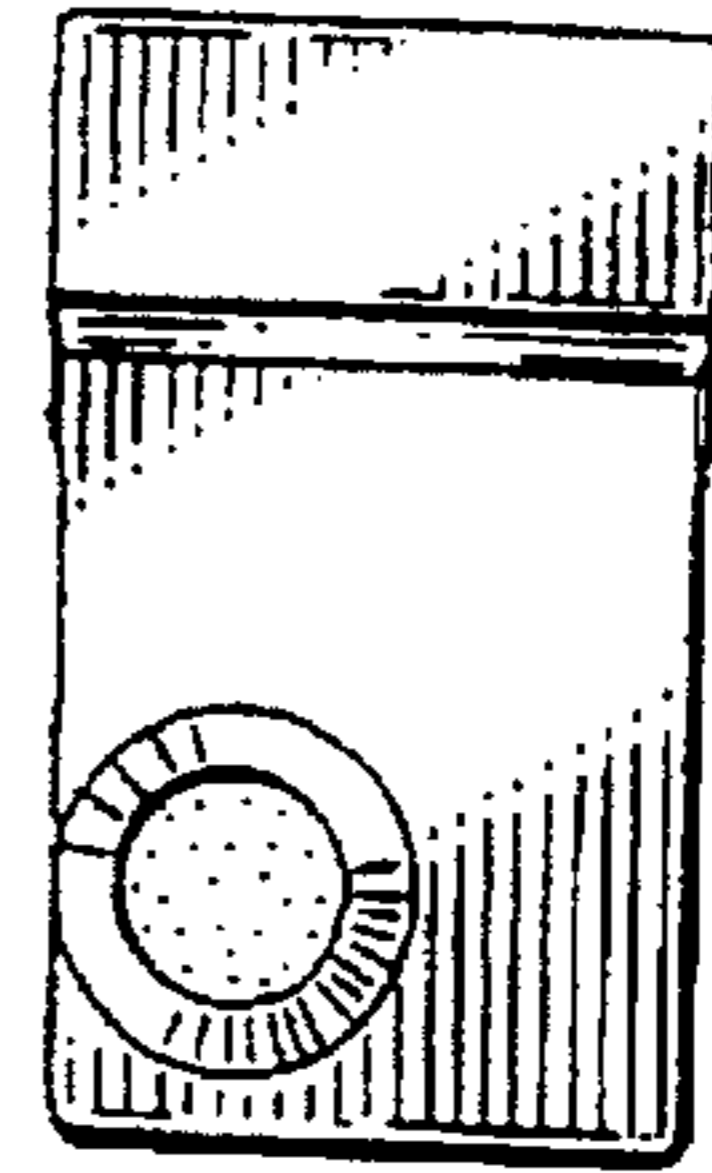

FIG. 9

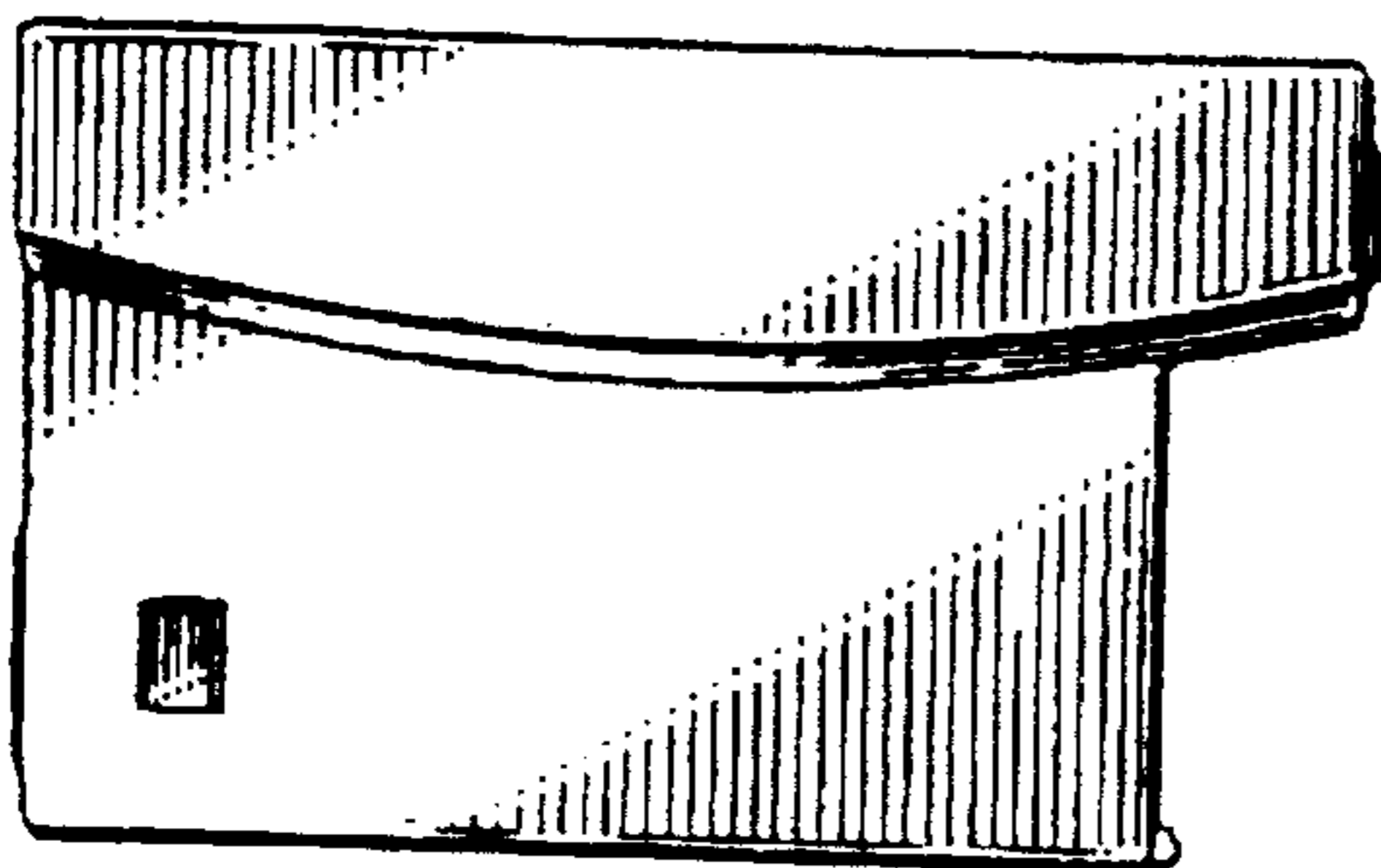

FIG. 12

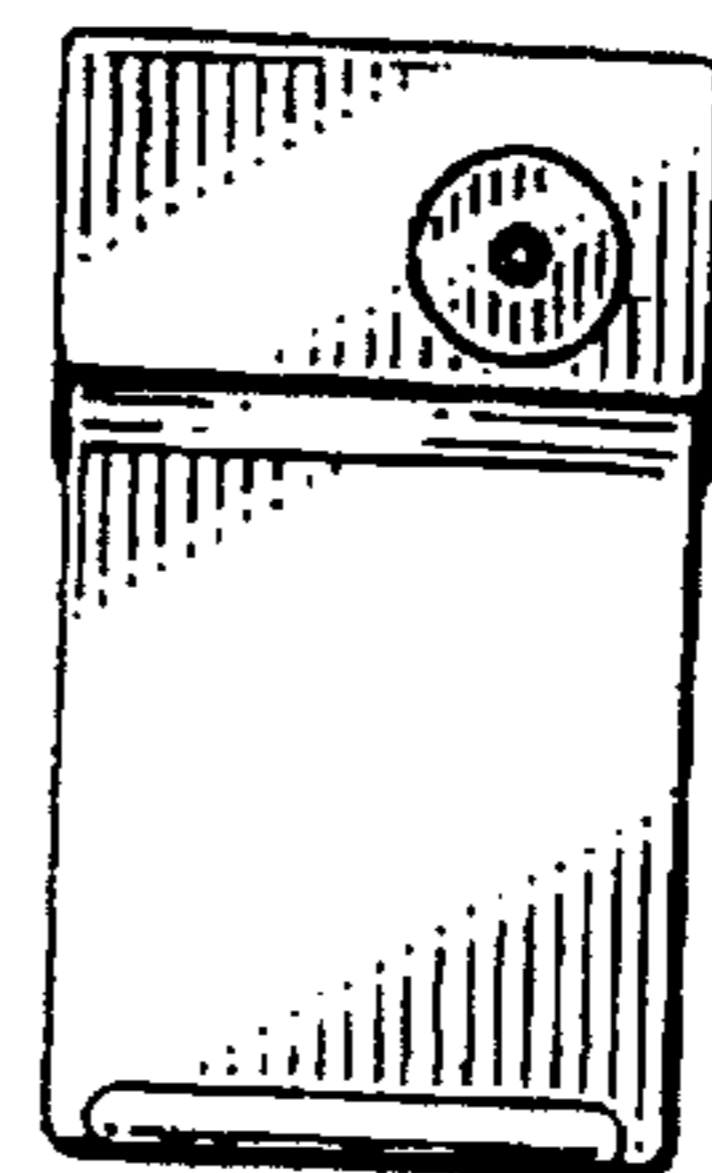

FIG. 10

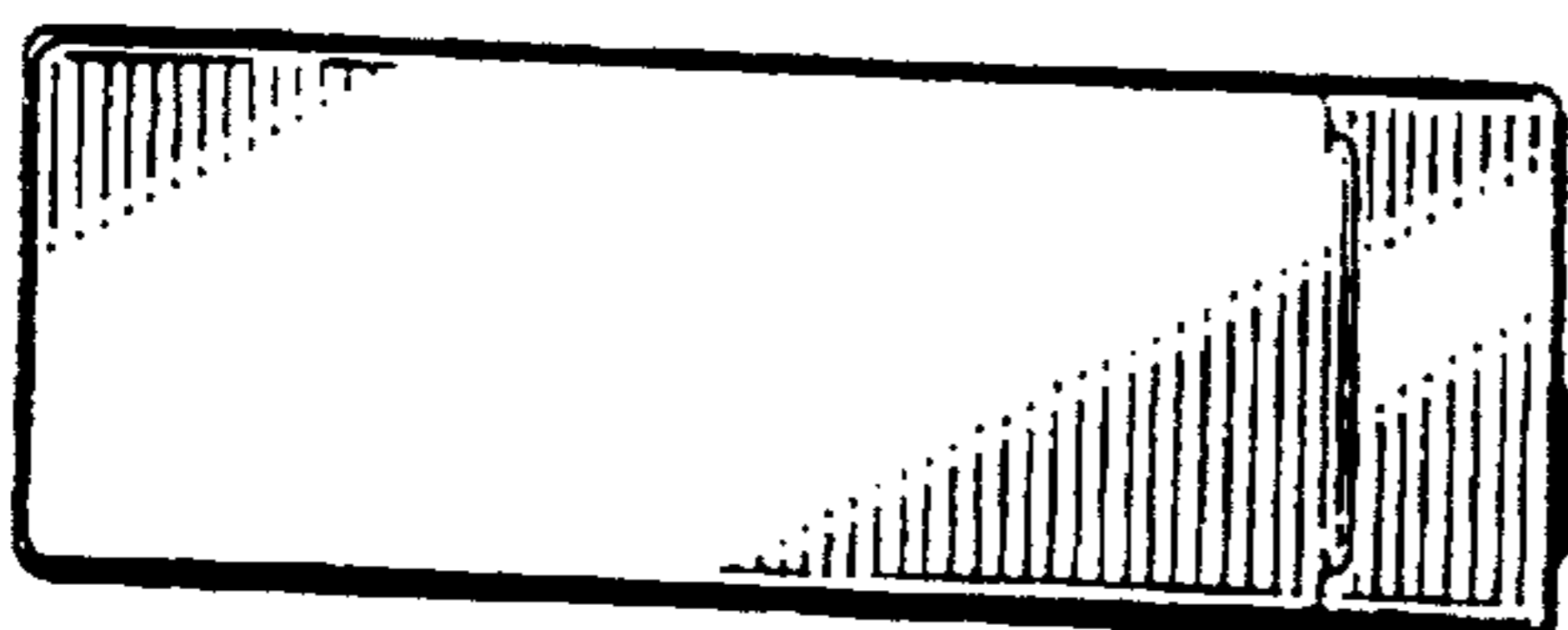

FIG. 13

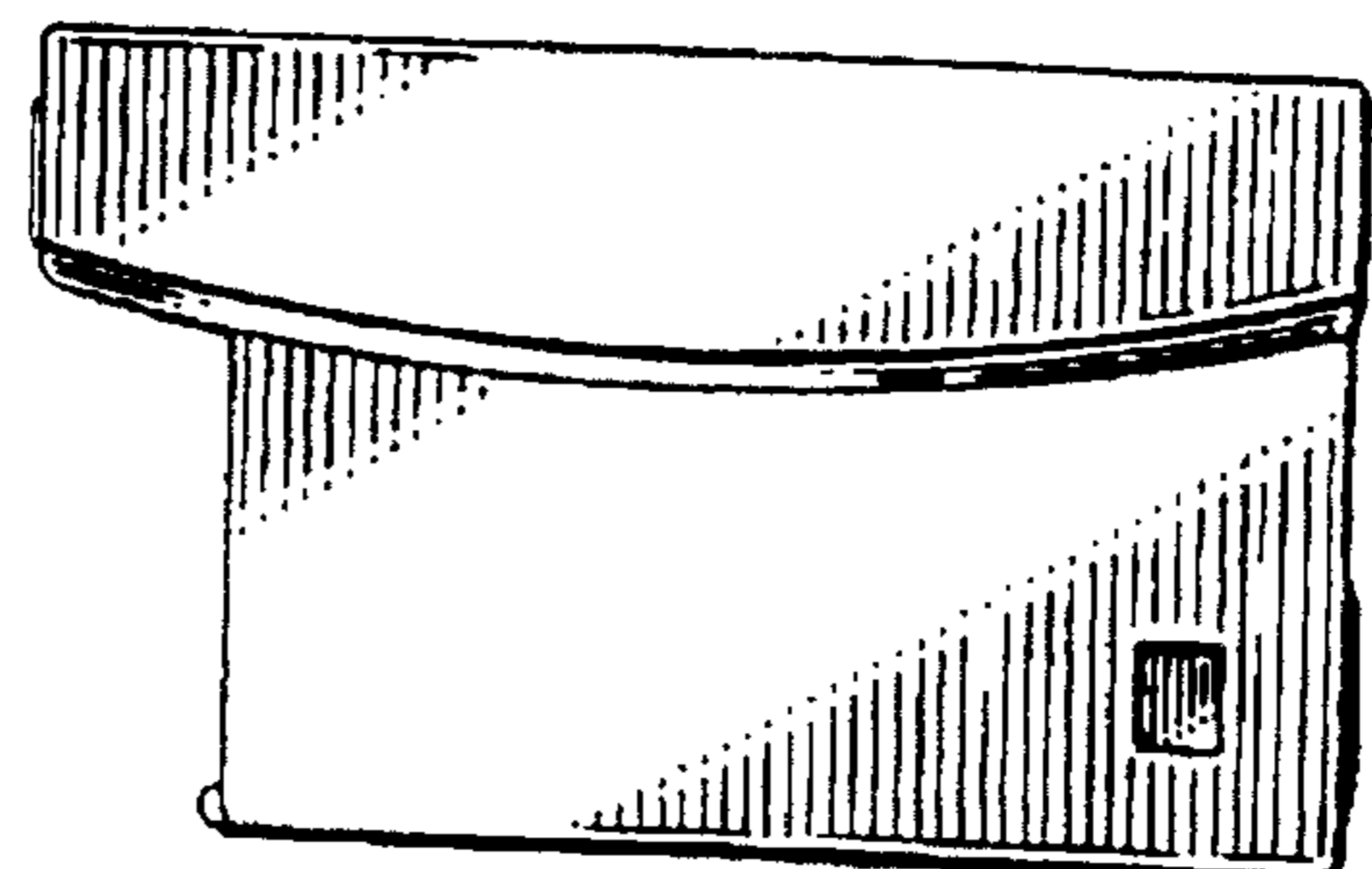

FIG. 14

