



US00D383362S

United States Patent [19]

[11] Patent Number: **Des. 383,362**

Ayotte et al.

[45] Date of Patent: ****Sep. 9, 1997**

[54] **CUPHOLDER WITH ELONGATED SUPPORT FOR ATTACHMENT TO FURNITURE**

[75] Inventors: **John Ayotte, Eagan; Peter W. A. Bergin, Hopkins, both of Minn.**

[73] Assignee: **MTS Northwest Sound, Inc., Minneapolis, Minn.**

[**] Term: **14 Years**

[21] Appl. No.: **48,487**

[22] Filed: **Dec. 29, 1995**

D. 319,951	9/1991	Frankel	D7/620
D. 328,223	7/1992	Clark	D7/622
D. 342,871	1/1994	Stern et al.	D7/620
D. 346,996	5/1994	Blackburn	D7/620
2,471,030	5/1949	Foulke	211/75
2,706,516	4/1955	Nordmark	155/188
2,877,976	3/1959	Massari	248/313
3,224,644	12/1965	Davis	222/162
3,508,732	4/1970	Trachtenberg et al.	248/226
4,865,237	9/1989	Allen	224/22.45
5,040,709	8/1991	Neugent	224/35
5,213,298	5/1993	Johnson	248/313
5,232,137	8/1993	Devine	224/252
5,248,770	9/1993	Louthan	248/311.2
5,320,319	6/1994	Winger et al.	248/312.1

Related U.S. Application Data

[60] Division of Ser. No. 26,729, Aug. 4, 1994, Pat. No. Des. 367,997, which is a continuation-in-part of Ser. No. 5,318, Feb. 26, 1993, abandoned.

[51] LOC (6) Cl. **07-06**

[52] U.S. Cl. **D7/620**

[58] Field of Search D7/619, 620, 622; 211/74, 75; 248/311.2, 313, 295.1; 215/395; 294/27.1, 31.2; 297/188.01, 188.02, 188.04, 188.21

References Cited

U.S. PATENT DOCUMENTS

D. 162,959	4/1951	Janes et al. .	
D. 244,302	5/1977	Bradley	D27/14
D. 307,852	5/1990	Clark	D7/620

Primary Examiner—Terry A. Wallace
Attorney, Agent, or Firm—Westman, Champlin & Kelly, P.A.

[57] CLAIM

The ornamental design for a cupholder with elongated support for attachment to furniture, as shown and described.

DESCRIPTION

FIG. 1 is a top plan view of a cupholder with elongated support for attachment to furniture showing our new design; FIG. 2 is a bottom plan view thereof; FIG. 3 is a side view thereof; FIG. 4 is a side view thereof; FIG. 5 is a front elevational view thereof; and, FIG. 6 is a rear elevational view thereof.

1 Claim, 4 Drawing Sheets

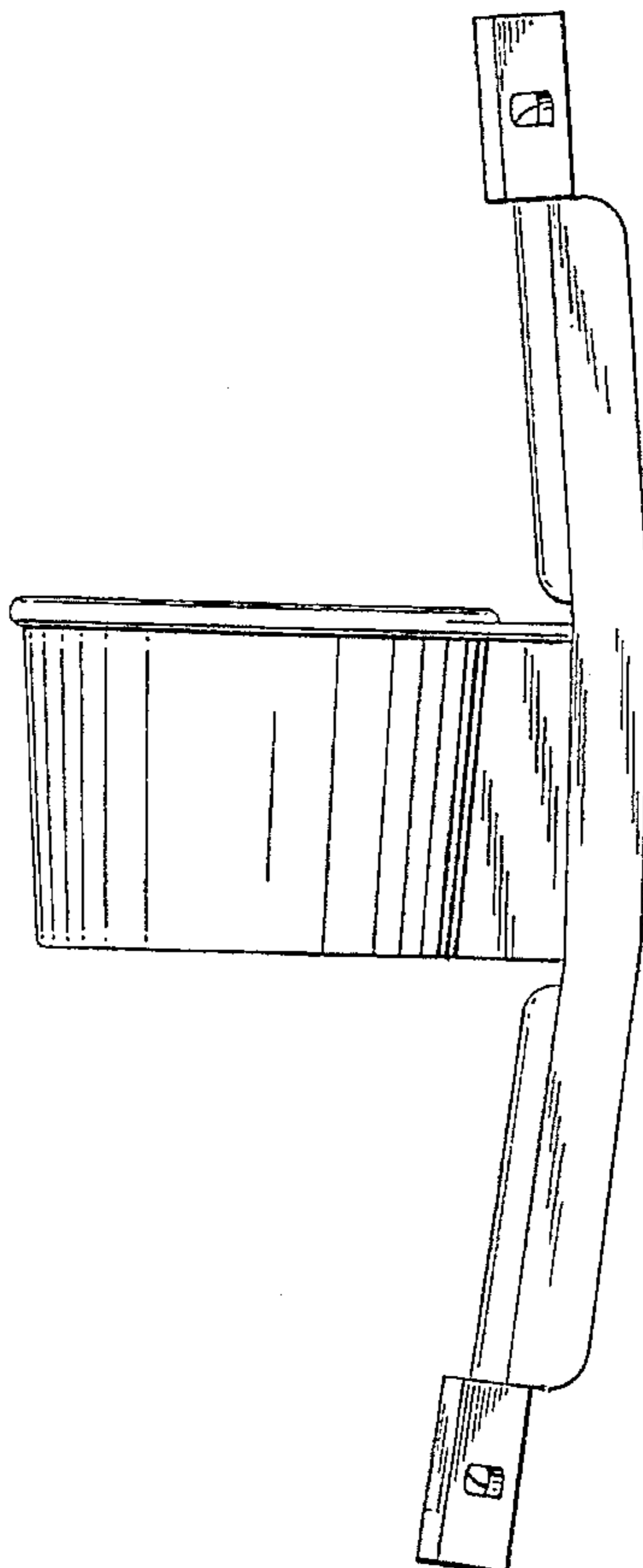
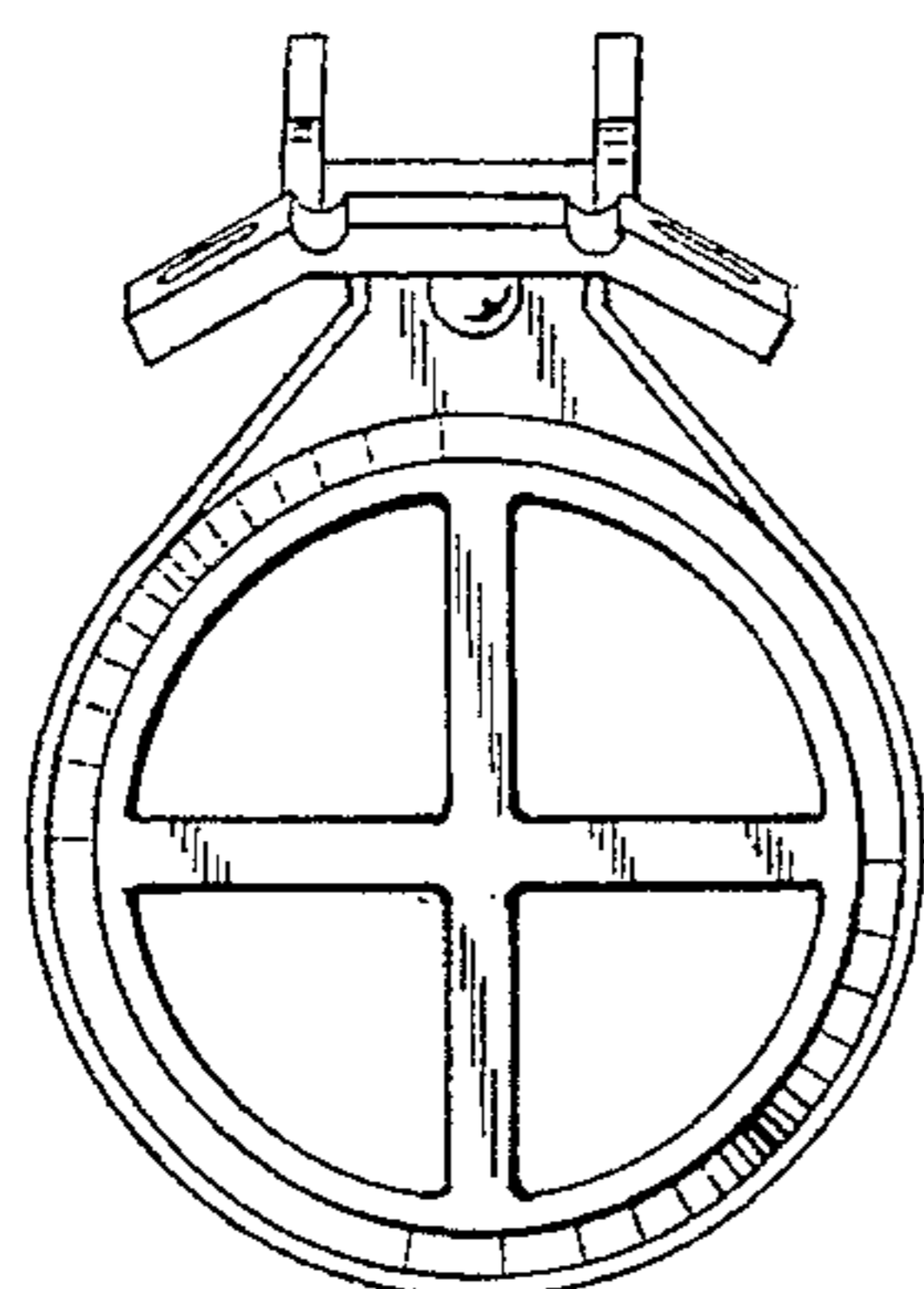

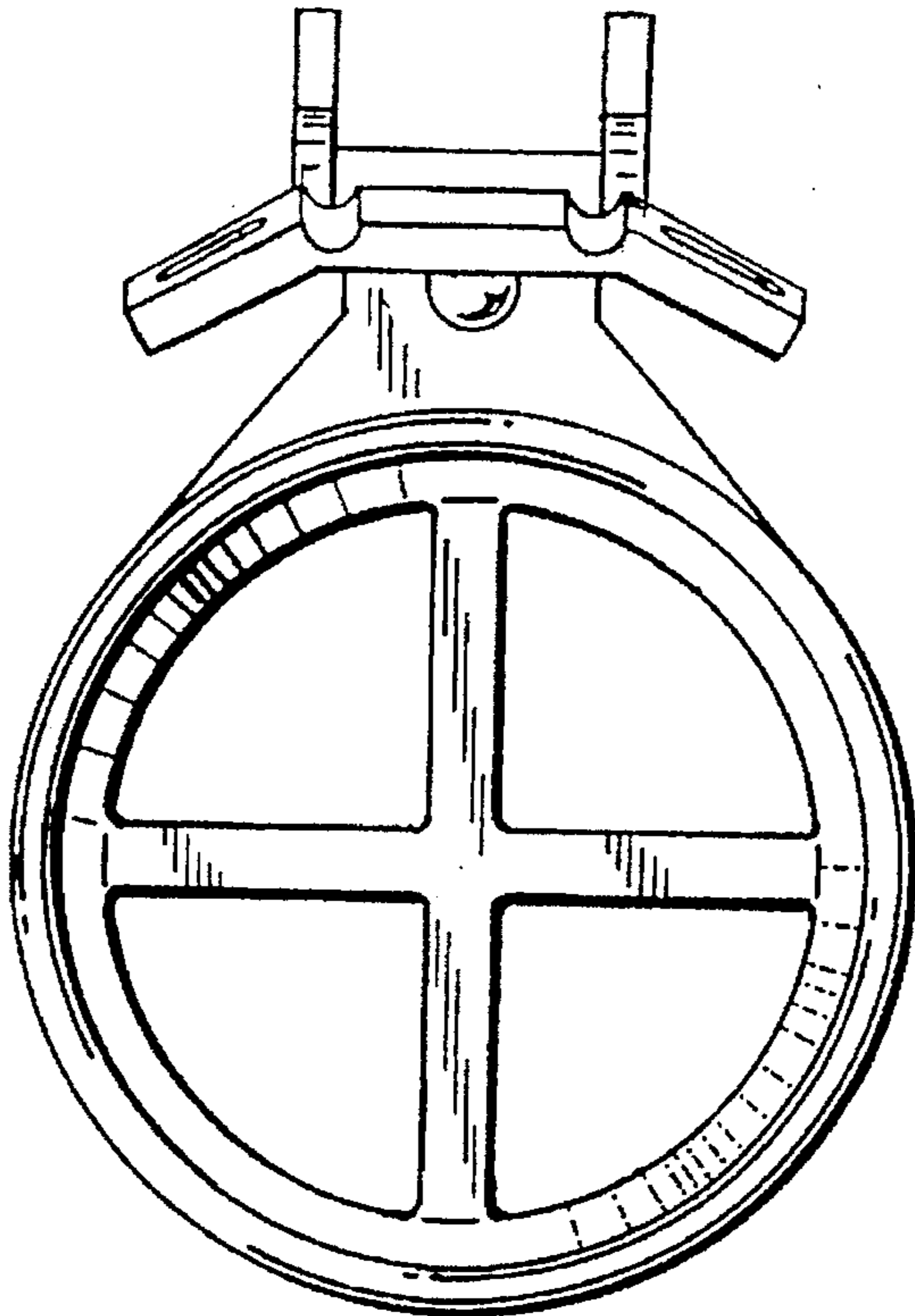

Fig. 1

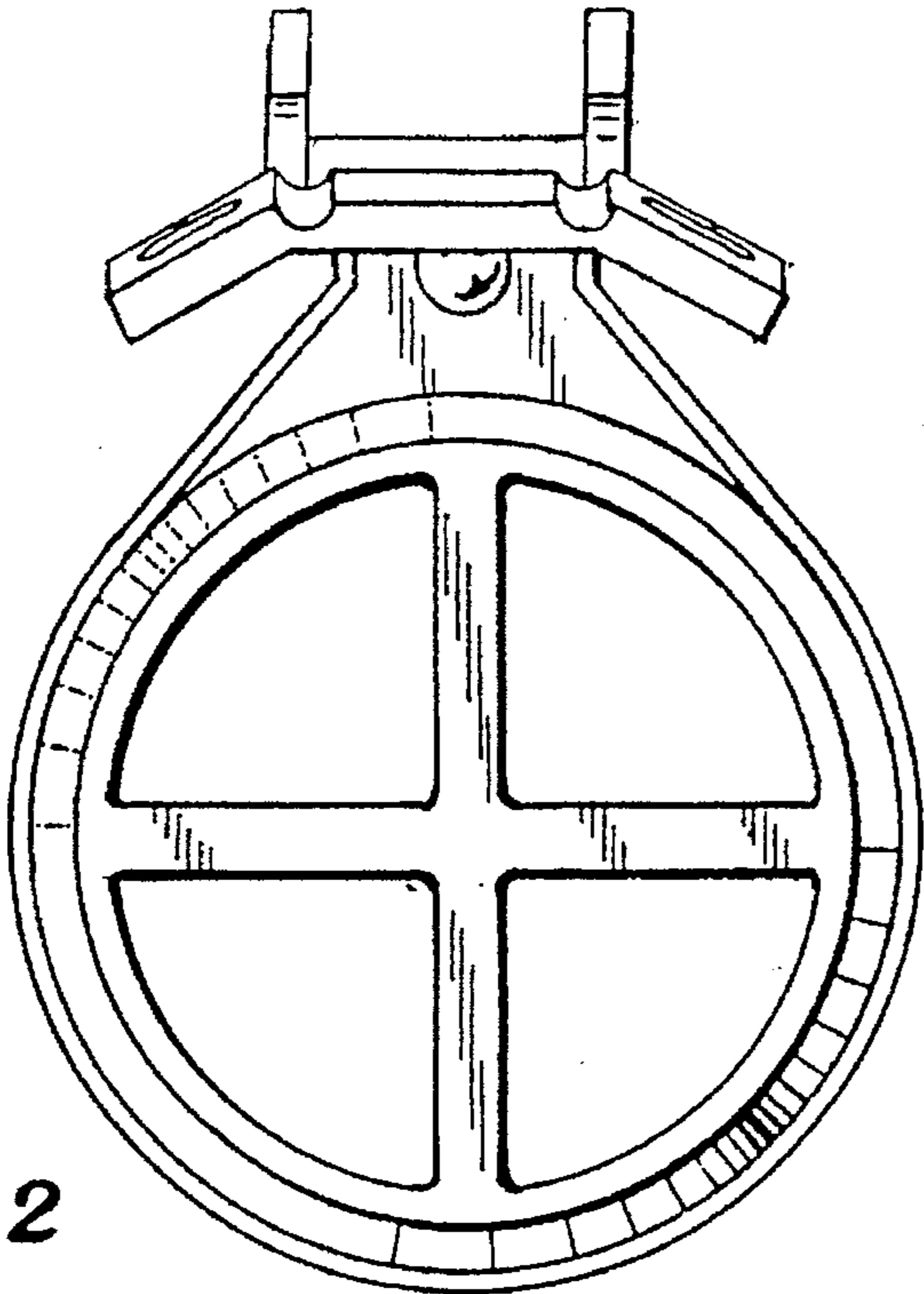

Fig. 2

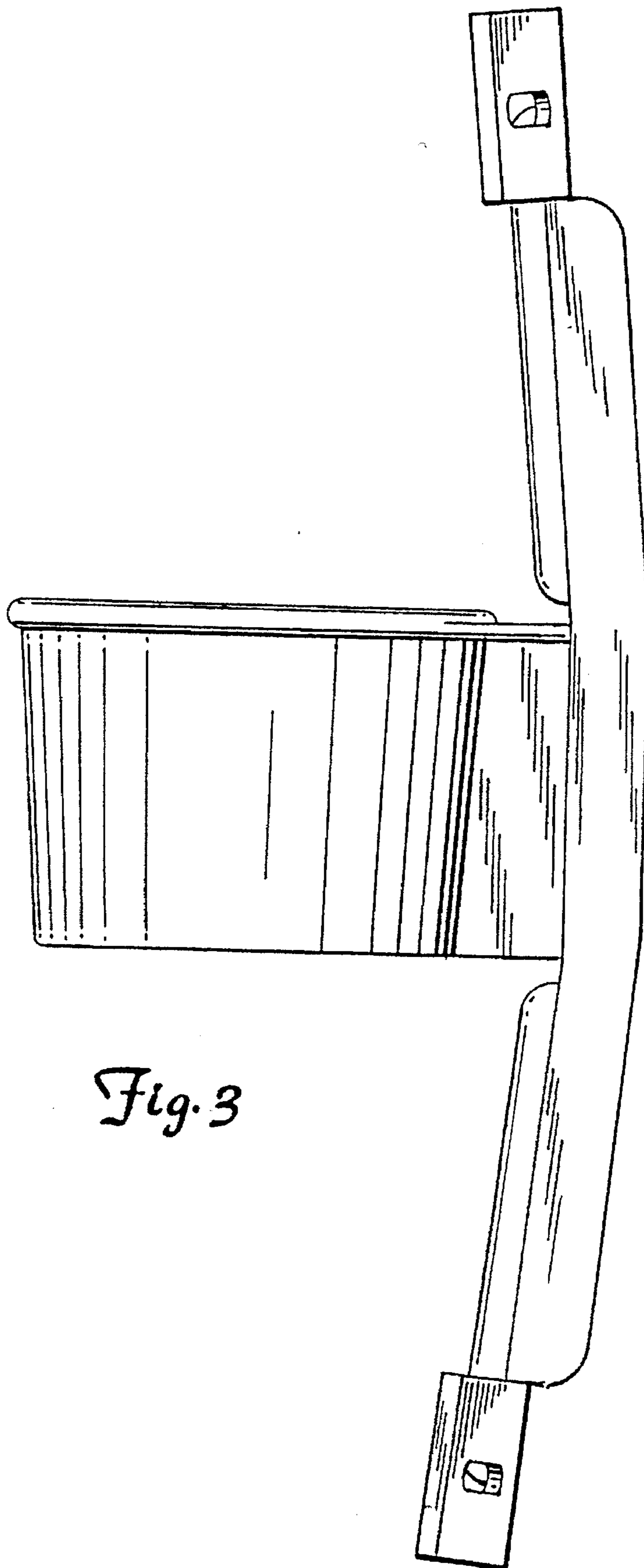

Fig. 3

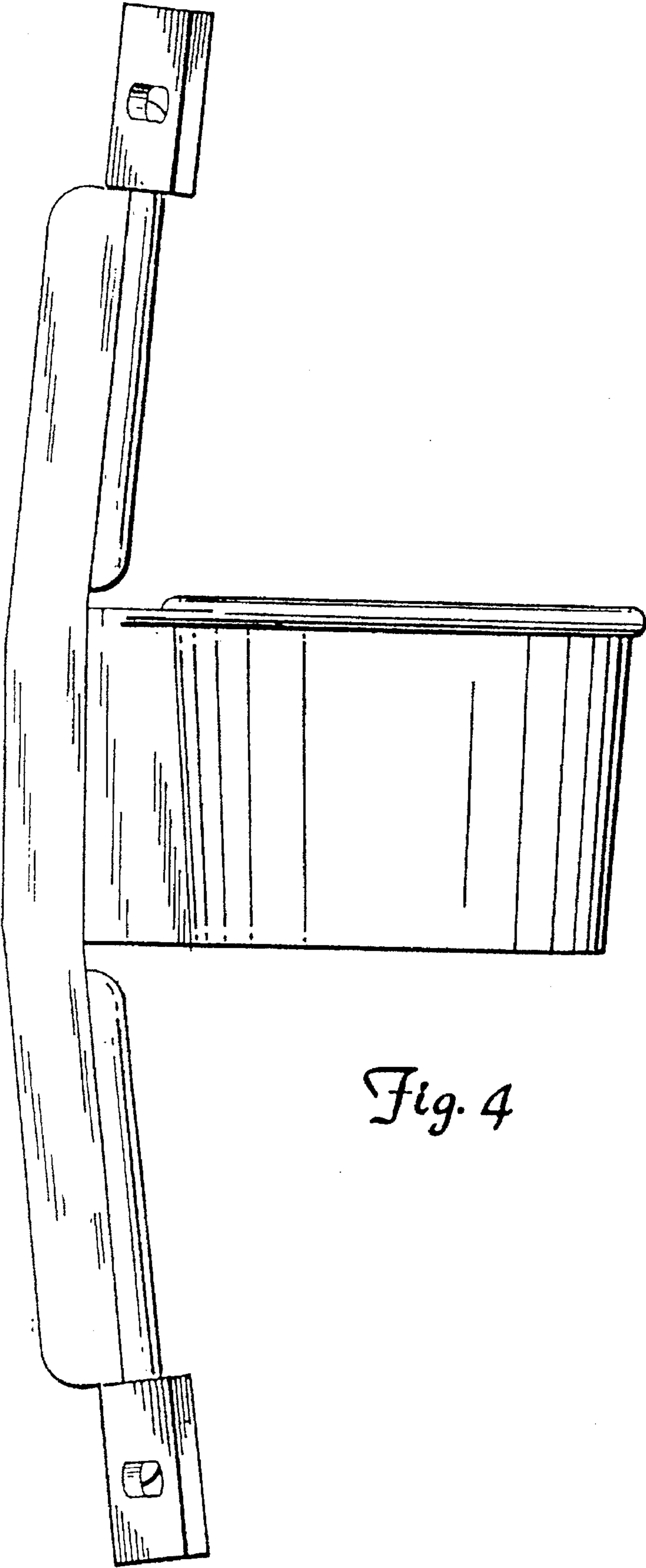

Fig. 4

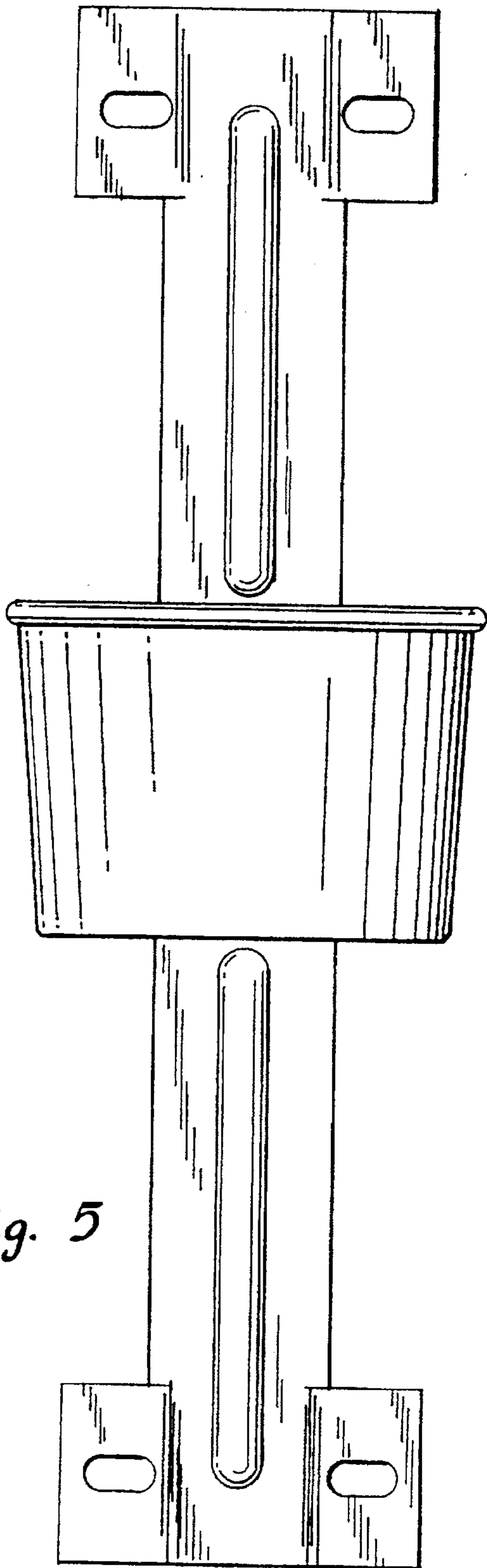

Fig. 5

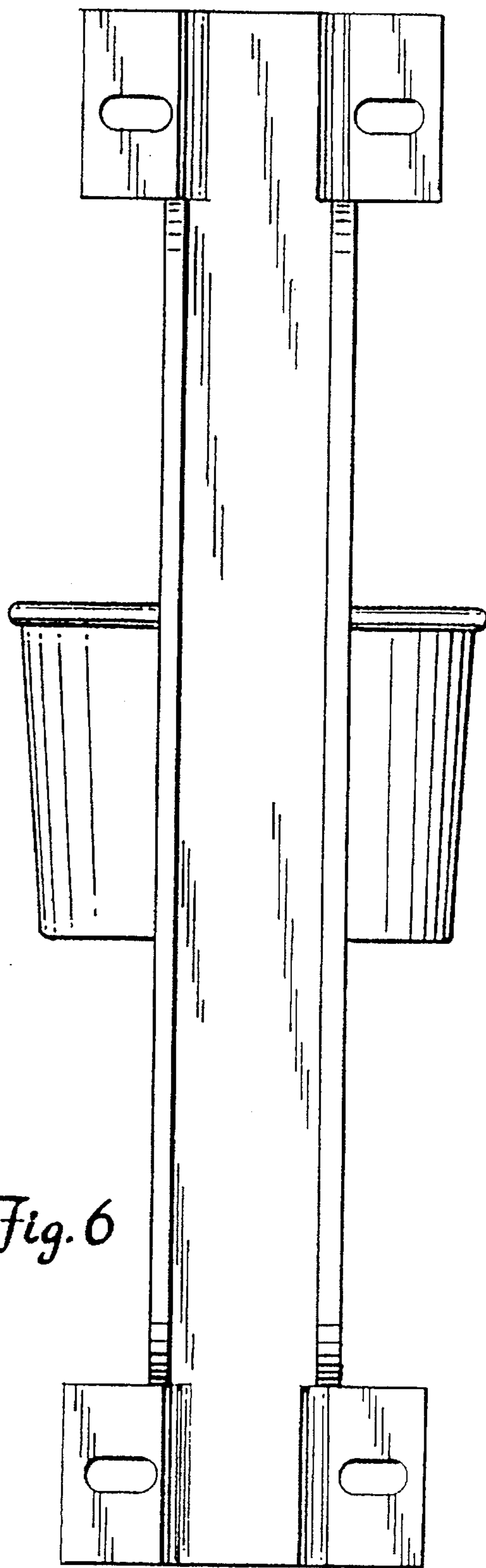

Fig. 6