



US00D383342S

United States Patent [19]
Duncan

[11] **Patent Number: Des. 383,342**

[45] **Date of Patent: **Sep. 9, 1997**

[54] **DECORATIVE HOLDER AND STORAGE
DEVICE FOR MULTIPLE ROLLS OF
TOILET PAPER**

D. 300,492 4/1989 Pearce D6/518
D. 330,984 11/1992 Evans D6/520
D. 341,968 12/1993 Kumerfield D6/518 X
D. 367,575 3/1996 Thompson D6/518

[76] **Inventor: Rena C. Duncan, 8207 N. Bronco La.,
Sherwood, Ark. 72116-3940**

Primary Examiner—Brian N. Vinson

[**] **Term: 14 Years**

[57] **CLAIM**

[21] **Appl. No.: 48,753**

The ornamental design for a decorative holder and storage device for multiple rolls of toilet paper, as shown and described.

[22] **Filed: Nov. 17, 1995**

DESCRIPTION

[51] **LOC (6) Cl. 07-07**

FIG. 1 is a front elevational view of the decorative holder and storage device for multiple rolls of toilet paper showing my new design;

[52] **U.S. Cl. D6/520**

FIG. 2 is a rear elevational view thereof;

[58] **Field of Search** D6/518-523; 242/590,
242/597, 598; 248/309.2; 312/34.1, 34.8,
34.23

FIG. 3 is a right view thereof;

FIG. 4 is a left view thereof;

FIG. 5 is a top plan view thereof;

FIG. 6 is a bottom plan view thereof; and,

FIG. 7 is an isometric view thereof.

[56] **References Cited**

U.S. PATENT DOCUMENTS

D. 205,184 7/1966 Johnson D6/520 X
D. 292,859 11/1987 Neumann D6/518

1 Claim, 4 Drawing Sheets

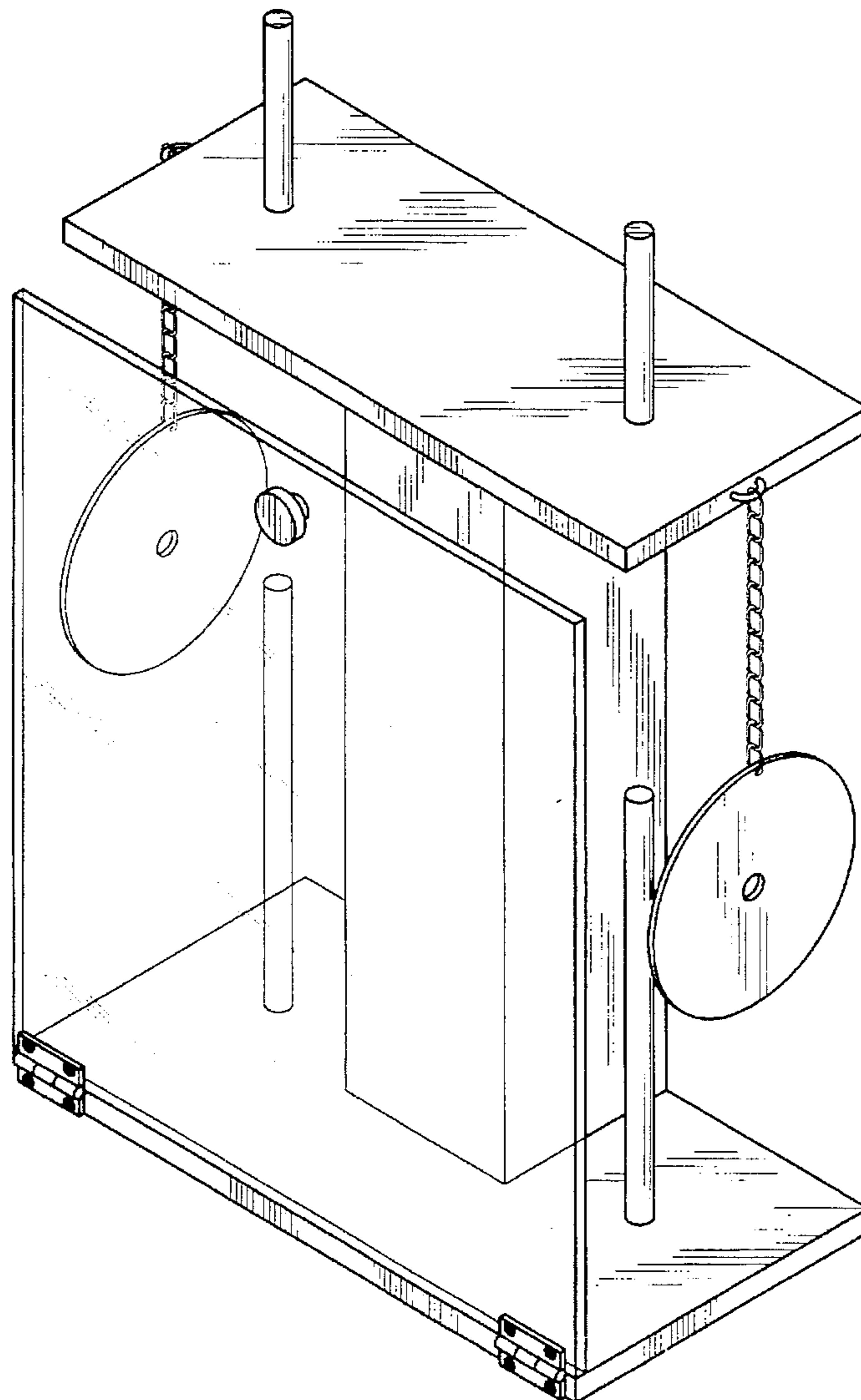

FIG. 1

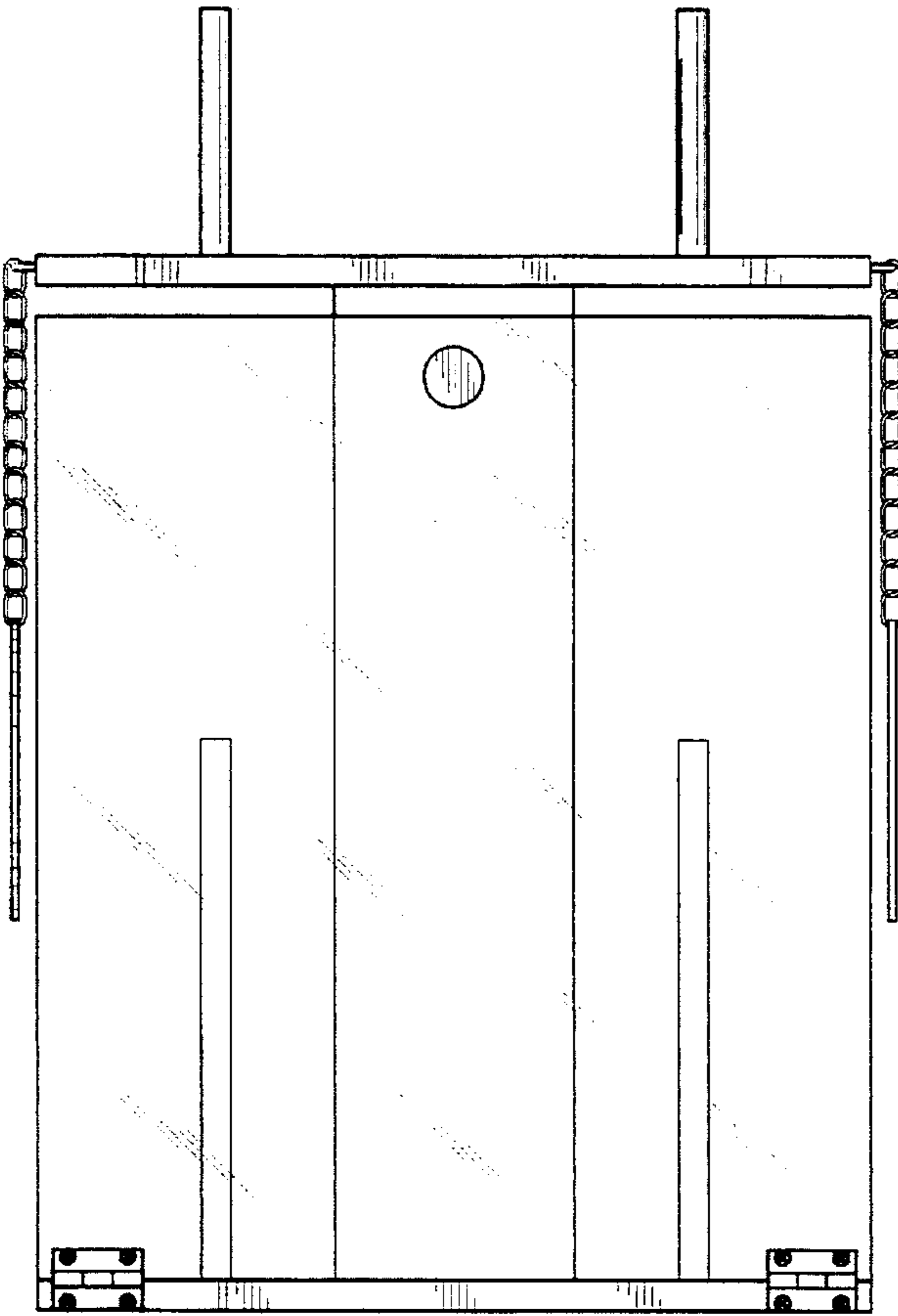

FIG. 2

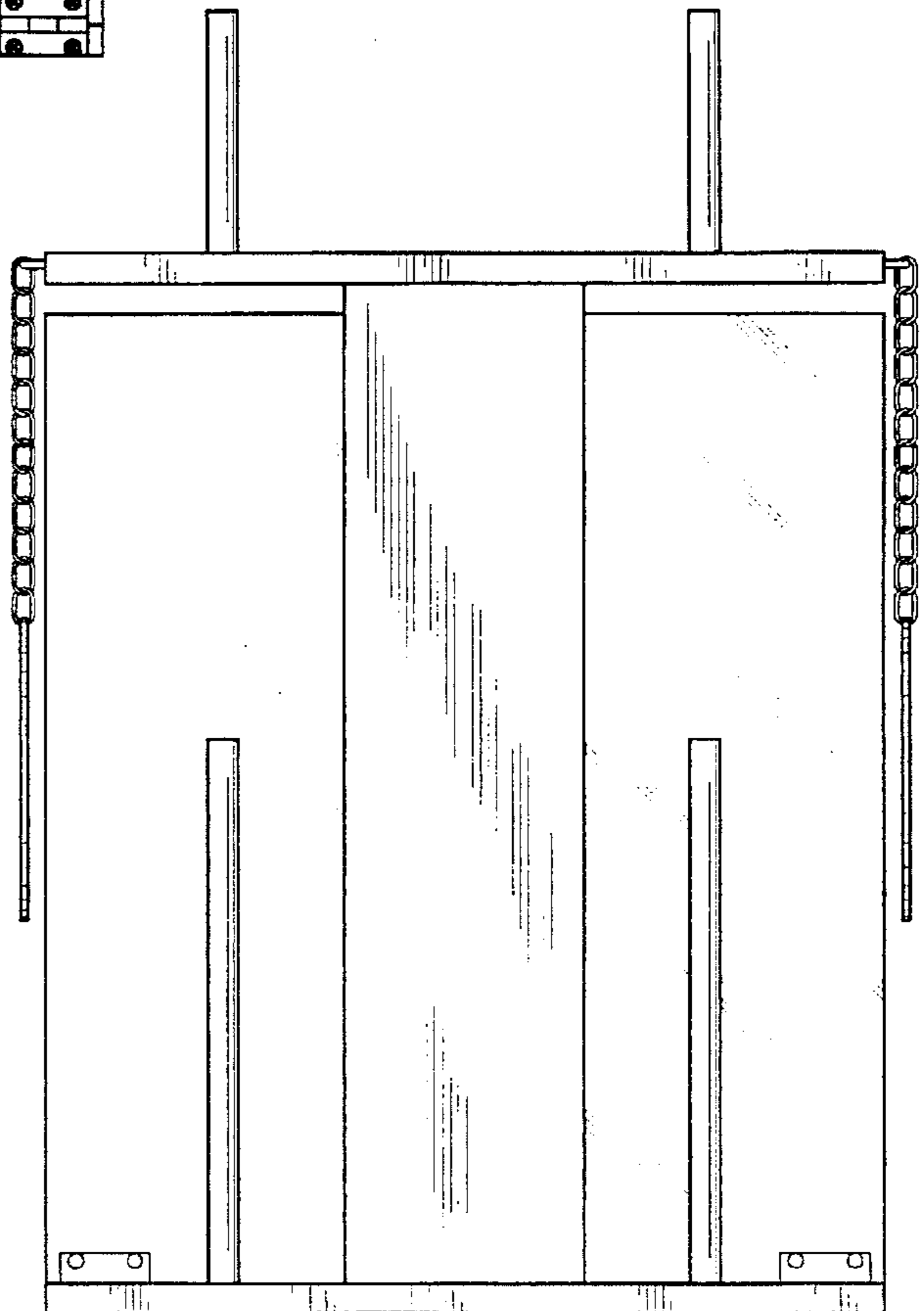

FIG. 3

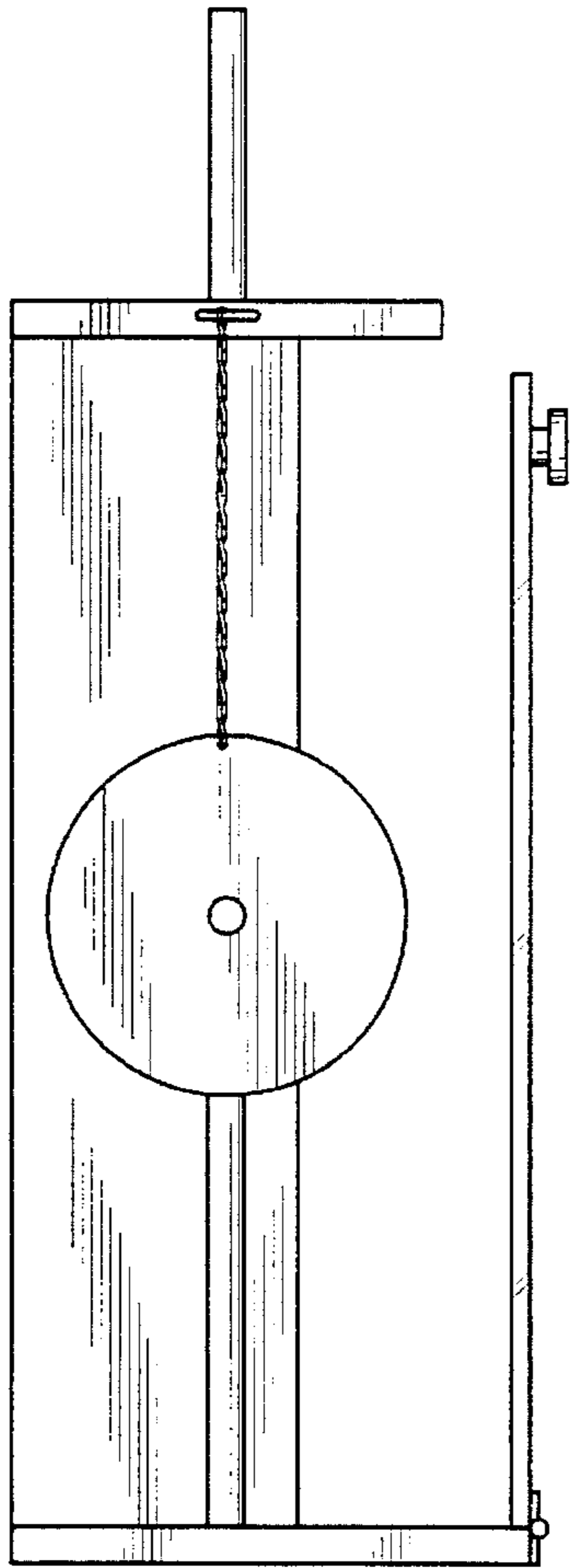

FIG. 4

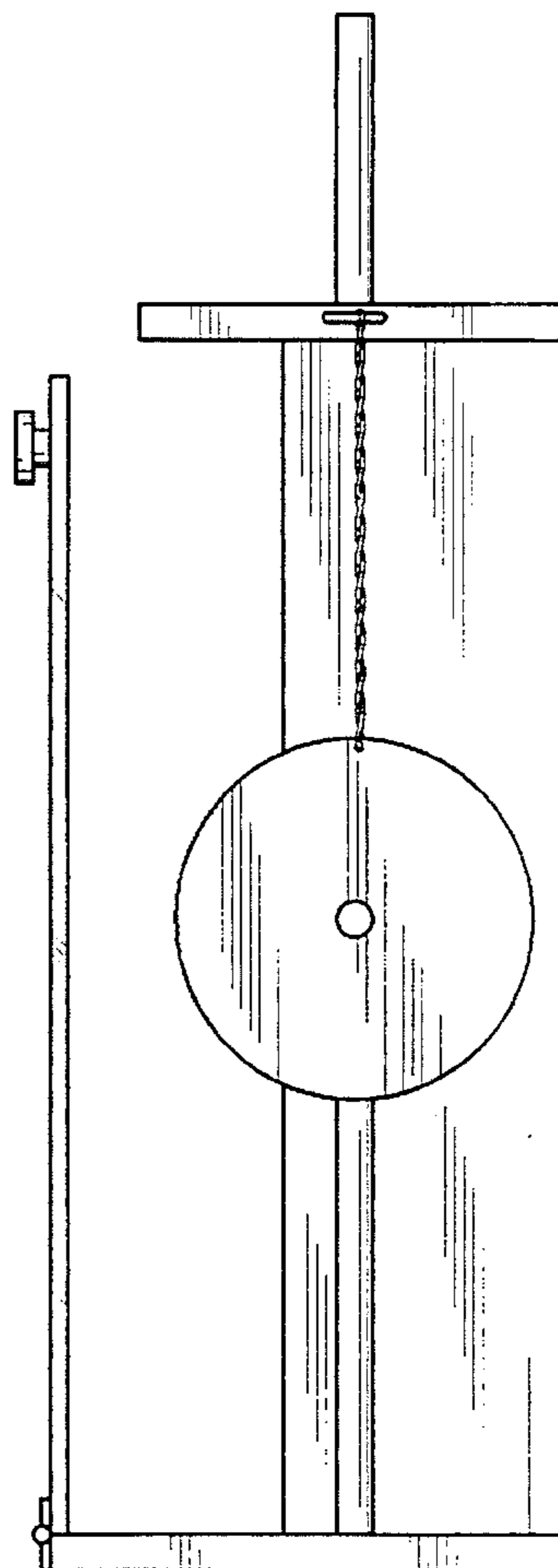

FIG. 5

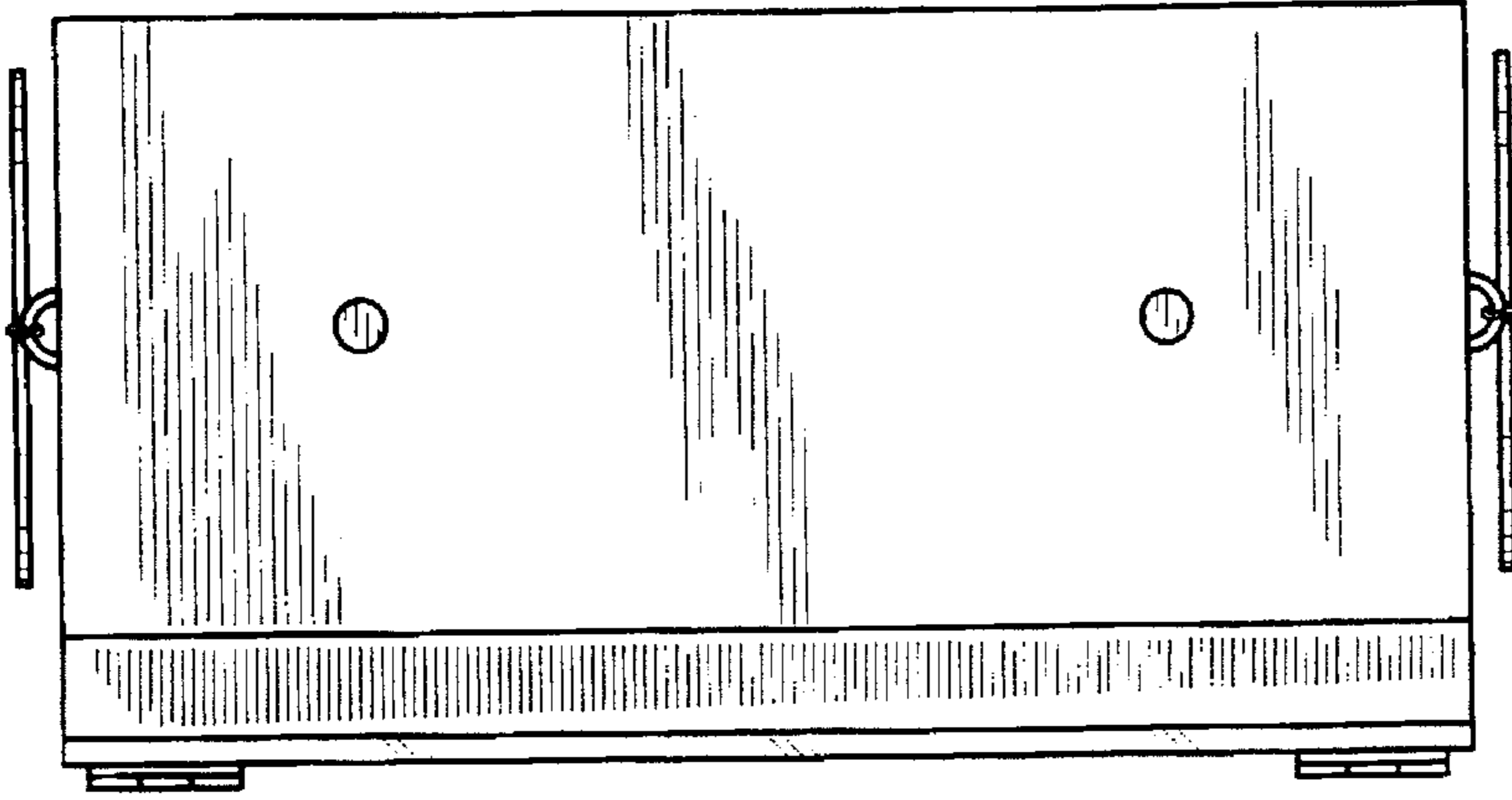

FIG. 6

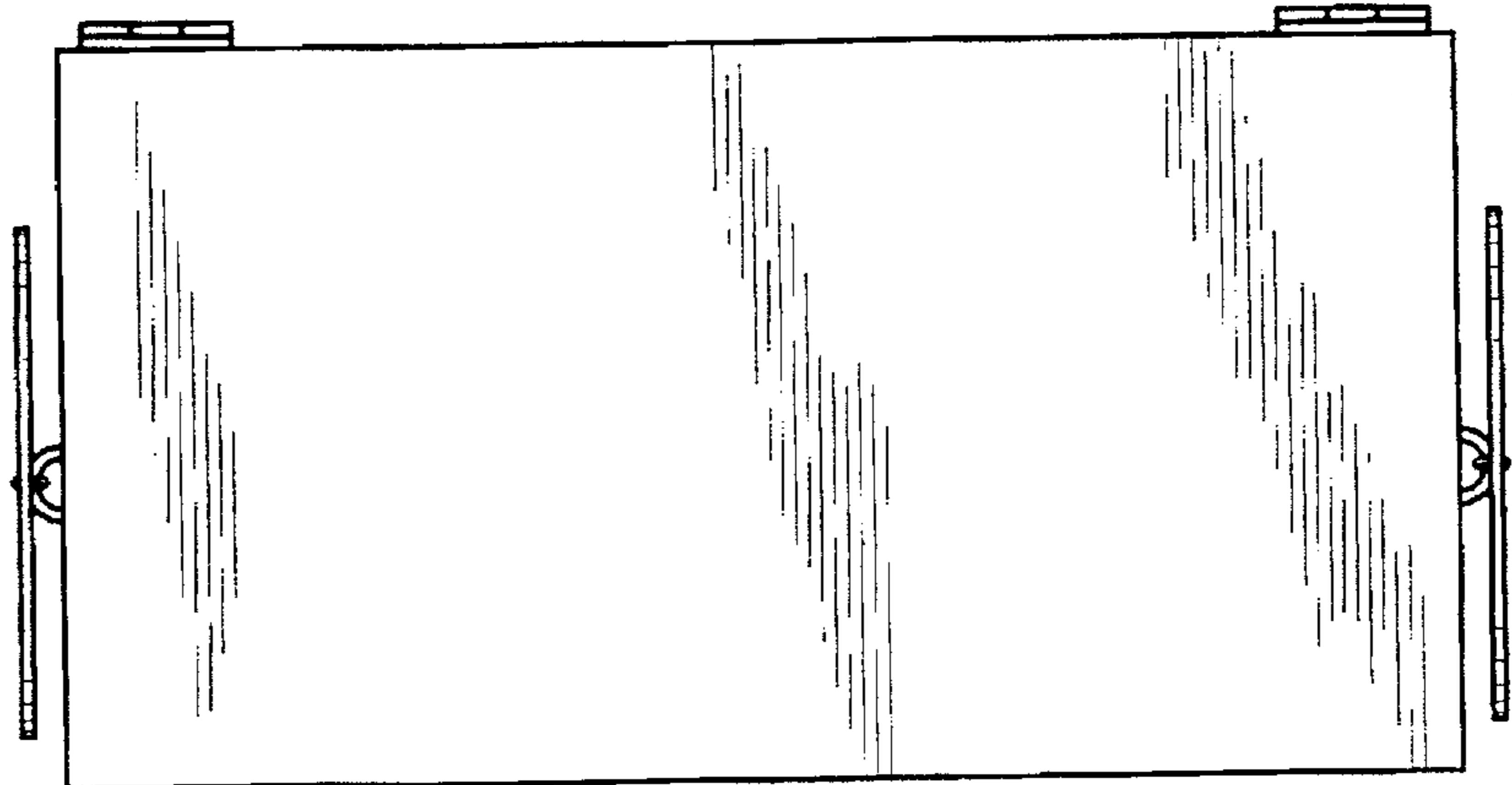

FIG. 7

