



US00D383232S

United States Patent [19] Huang

[11] Patent Number: **Des. 383,232**

[45] Date of Patent: ****Sep. 2, 1997**

[54] **MULTI-FUNCTION LANTERN**

D. 344,152 2/1994 Yuen D26/38
D. 356,649 3/1995 Yuen D26/42

[75] Inventor: **Rongquan Huang**, Shantou, China

Primary Examiner—Marcus A. Jackson

[73] Assignee: **Shantou Shanhe Electric Equipment Industrial Co.**, Guangdong Province, China

Attorney, Agent, or Firm—Beveridge, DeGrandi, Weilacher & Young, L.L.P.

[**] Term: **14 Years**

[57] CLAIM

[21] Appl. No.: **38,335**

The ornamental design for a multi-function lantern, as shown and described.

[22] Filed: **May 3, 1995**

DESCRIPTION

[30] **Foreign Application Priority Data**

Apr. 6, 1995 [CN] China 95 3 03678.2

FIG. 1 is a front view of a multi-function lantern showing my new design;

[51] LOC (6) Cl. **26-02**

FIG. 2 is a left side view thereof;

[52] U.S. Cl. **D26/44**

FIG. 3 is a top view thereof;

[58] Field of Search D26/37-50; 362/157, 362/158, 183-191, 194-202

FIG. 4 is a rear view thereof;

FIG. 5 is a right side view thereof;

FIG. 6 is a bottom view thereof; and,

FIG. 7 a front elevational view thereof, with the lantern portion shown in an alternate position.

[56] **References Cited**

U.S. PATENT DOCUMENTS

D. 335,715 5/1993 Wan D26/42

1 Claim, 3 Drawing Sheets

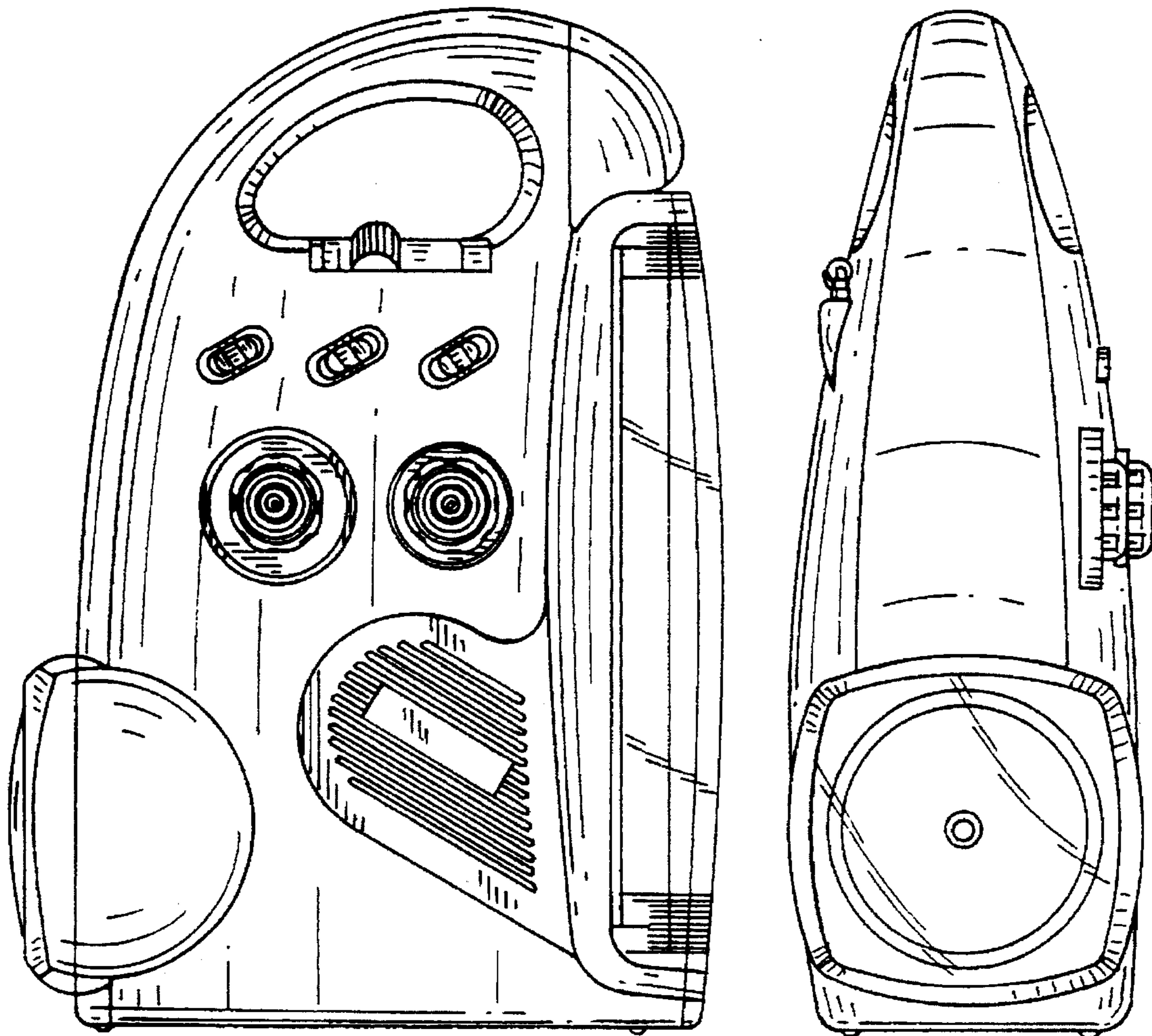

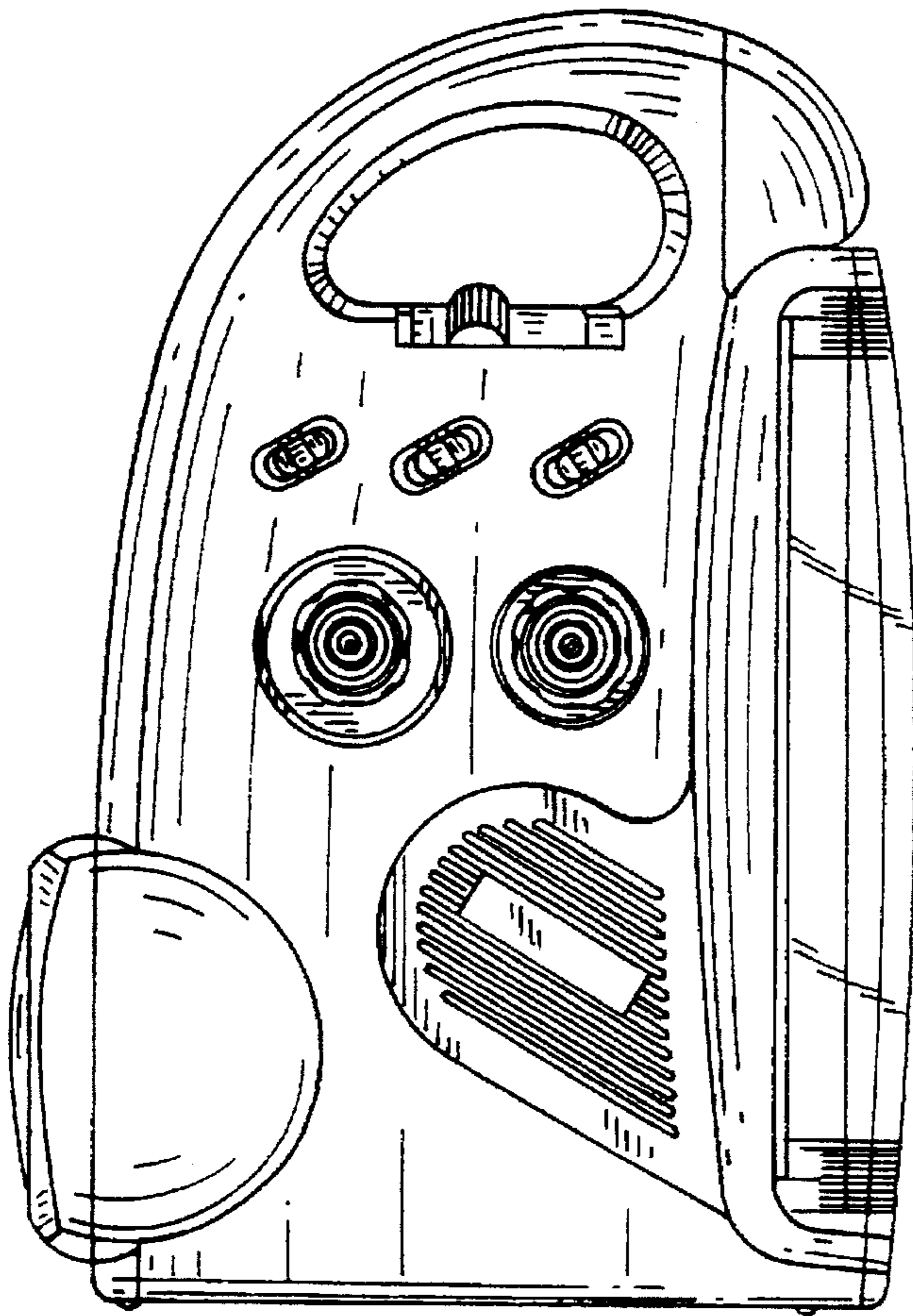

FIG. 1

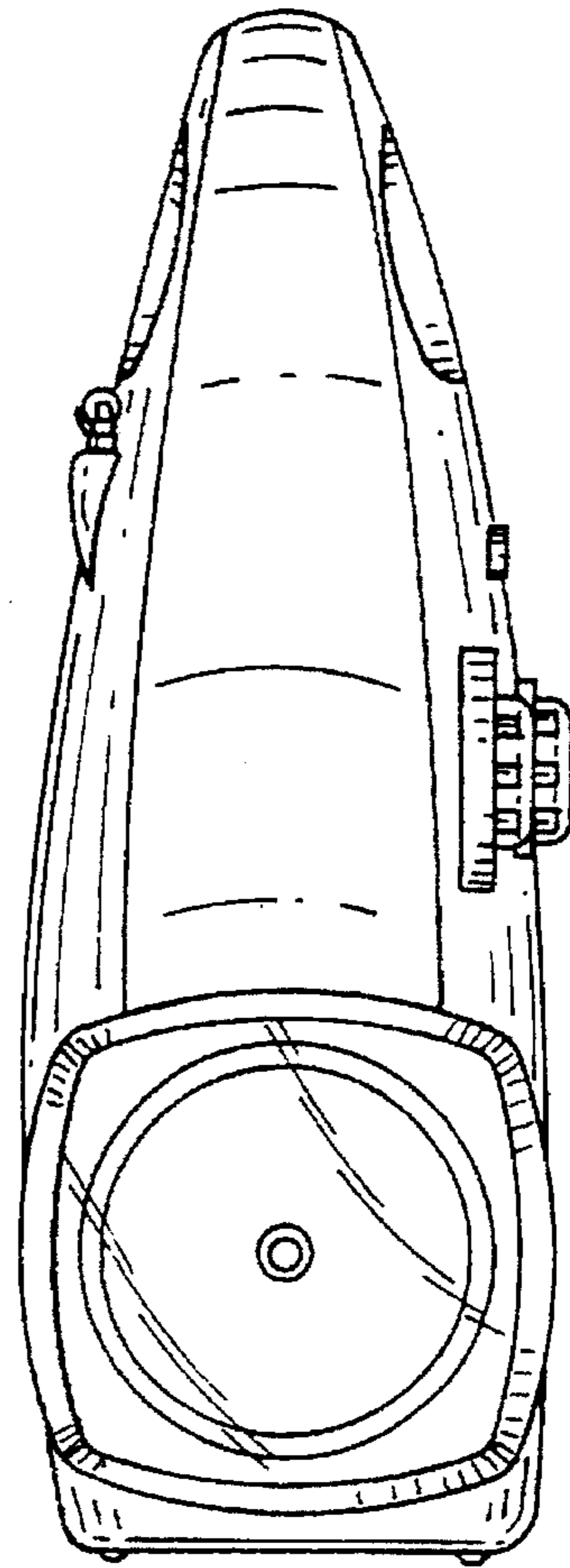

FIG. 2

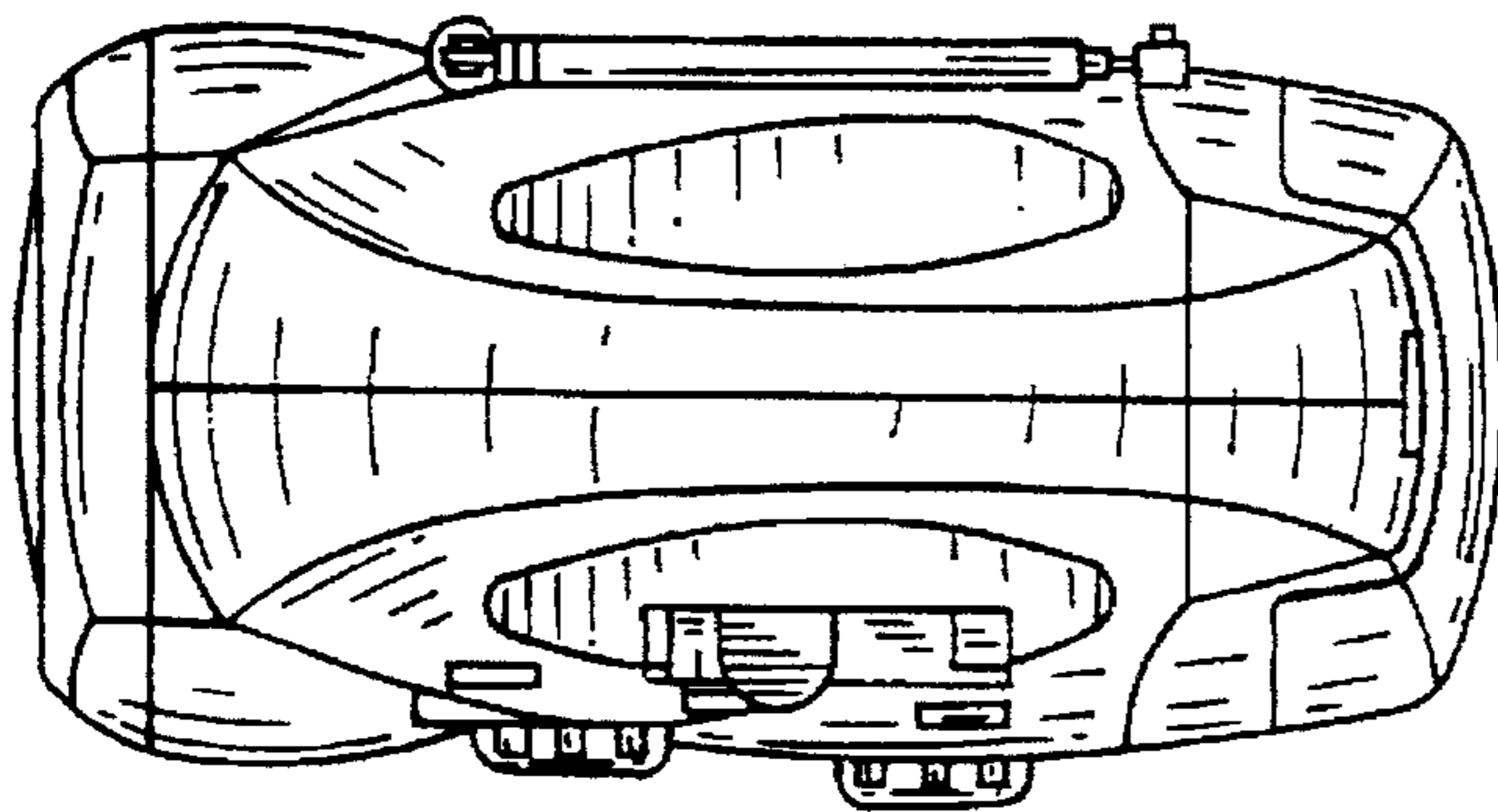

FIG. 3

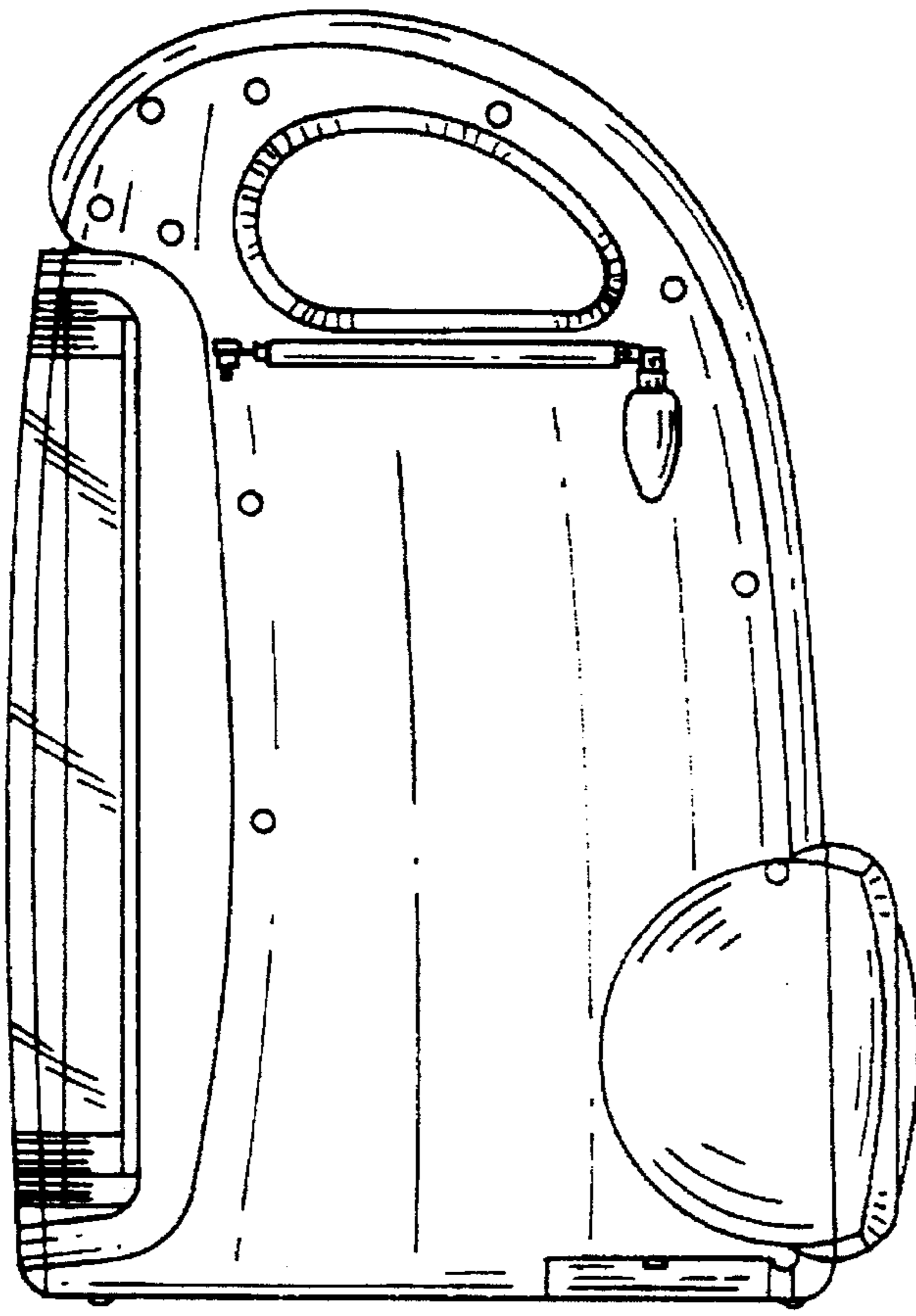

FIG. 4

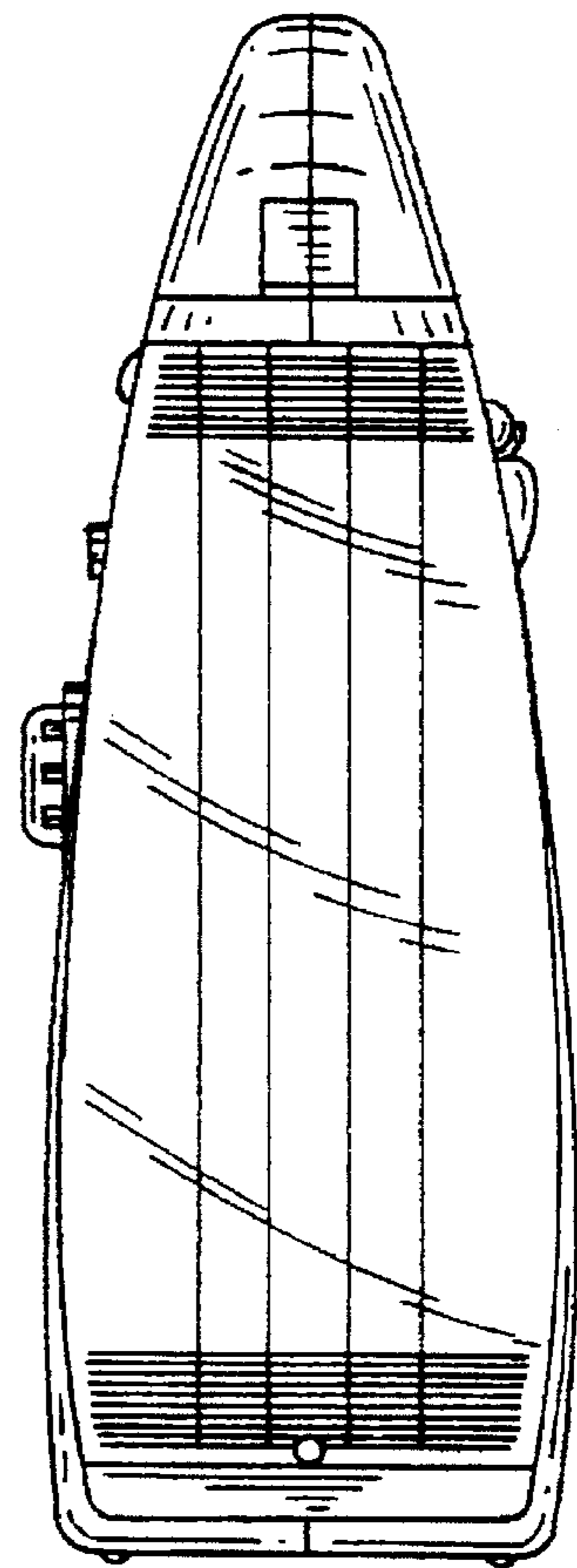

FIG. 5

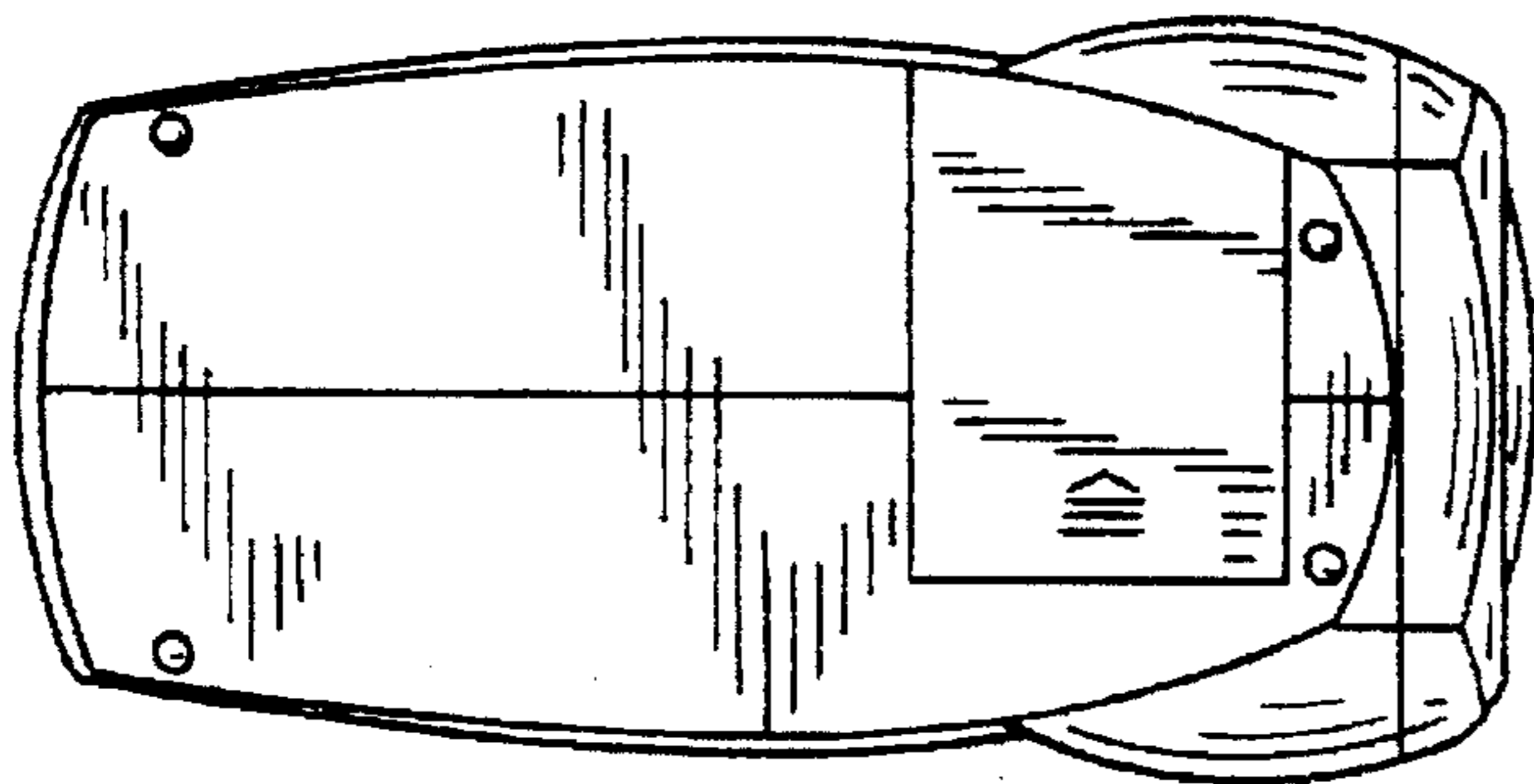

FIG. 6

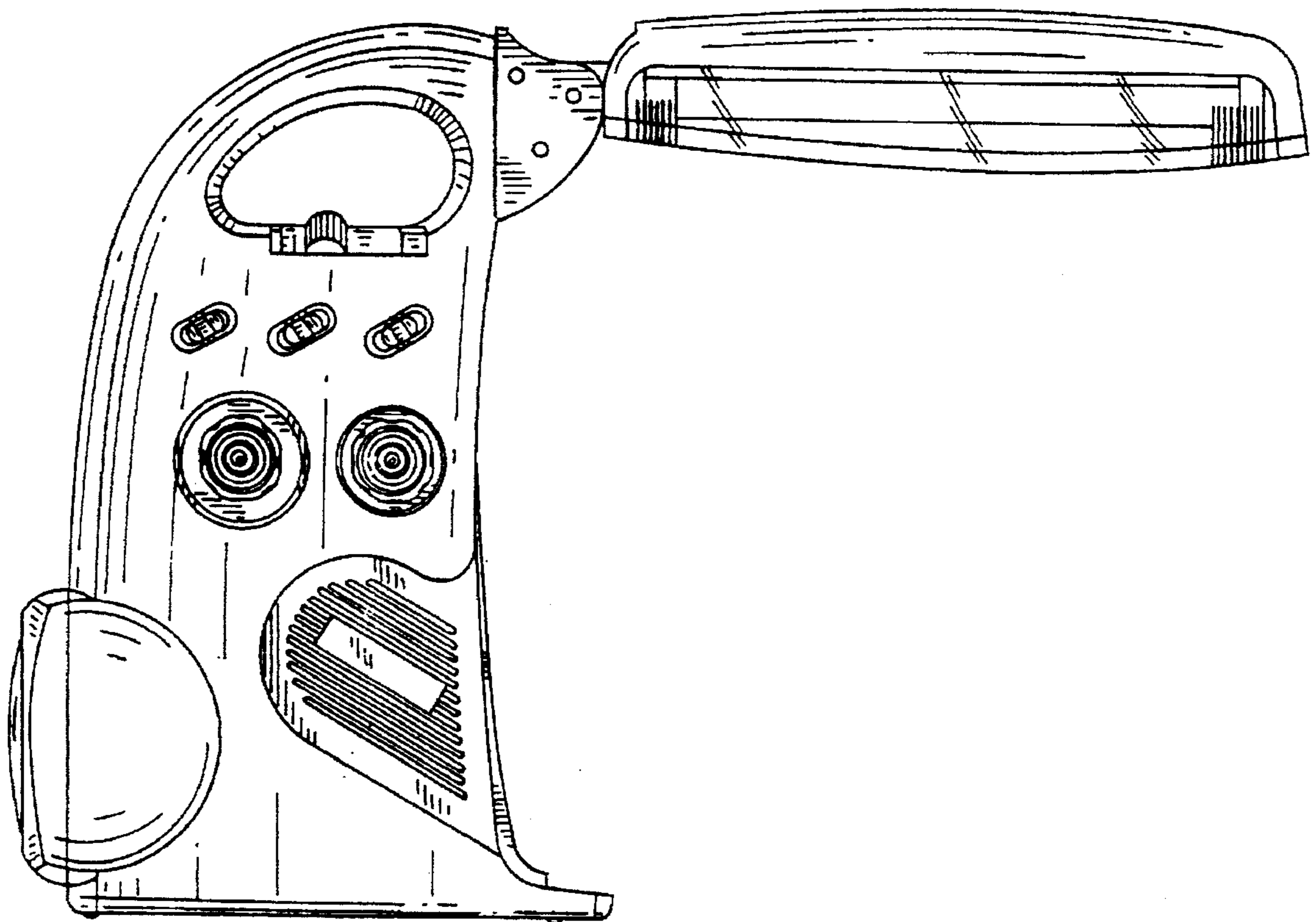

FIG. 7