

US00D383198S

United States Patent [19]

[11] Patent Number: Des. 383,198

Jacuzzi et al.

[45] Date of Patent: **Sep. 2, 1997

[54] COMBINED WHIRLPOOL BATHTUB AND SHOWER STALL

[75] Inventors: Roy Aldo Jacuzzi, Orinda; Ralph D'Innocente, Benicia, both of Calif.

[73] Assignee: Jacuzzi, Inc., Walnut Creek, Calif.

[**] Term: 14 Years

[21] Appl. No.: 26,700

[22] Filed: Aug. 4, 1994

[51] LOC (6) Cl. 23-02

[52] U.S. Cl. D23/275

[58] Field of Search D23/255, 277, D23/279, 280.1, 280.2, 280.4, 283; 4/596, 600, 604, 605, 602, 607, 610, 612

[56] References Cited

U.S. PATENT DOCUMENTS

D. 319,093	8/1991	Dannenberg et al.	D23/275
D. 332,995	2/1993	Dworetzky	D23/275
D. 341,192	11/1993	Dworetzky	D23/275
D. 346,015	4/1994	Maskell et al.	D23/275
4,928,329	5/1990	Palmeri	4/604 X
5,070,549	12/1991	Campe	4/496

Primary Examiner—Louis S. Zarfaz

Assistant Examiner—Eric Watterson

Attorney, Agent, or Firm—Glen R. Grunewald

[57] CLAIM

The ornamental design for a combined whirlpool bathtub and shower stall, as shown.

DESCRIPTION

FIG. 1 is a top right side perspective view of a combined whirlpool bathtub and shower stall, showing my new design;

FIG. 2 is a left side perspective view of the whirlpool bathtub portion of the claimed design;

FIG. 3 is a top plan view thereof;

FIG. 4 is a front elevational view thereof;

FIG. 5 is a cross-sectional view taken along line 5—5 of FIG. 3;

FIG. 6 is a cross-sectional view taken along line 6—6 of FIG. 3;

FIG. 7 is a right side perspective view of the shower portion of FIG. 1;

FIG. 8 is a side elevational view taken in the direction of arrows of 8—8 of FIG. 10;

FIG. 9 is a side elevational view taken in the direction of arrows of 9—9 of FIG. 10;

FIG. 10 is a top plan view of FIG. 7;

FIG. 11 is a cross-sectional view taken along line 11—11 of FIG. 12;

FIG. 12 is a cross-sectional view taken along line 12—12 of FIG. 7; and,

FIG. 13 is a side elevational view taken in the direction of arrows 13—13 of FIG. 10.

The broken line showing is for illustrative purposes only and forms no part of the claimed design.

1 Claim, 12 Drawing Sheets

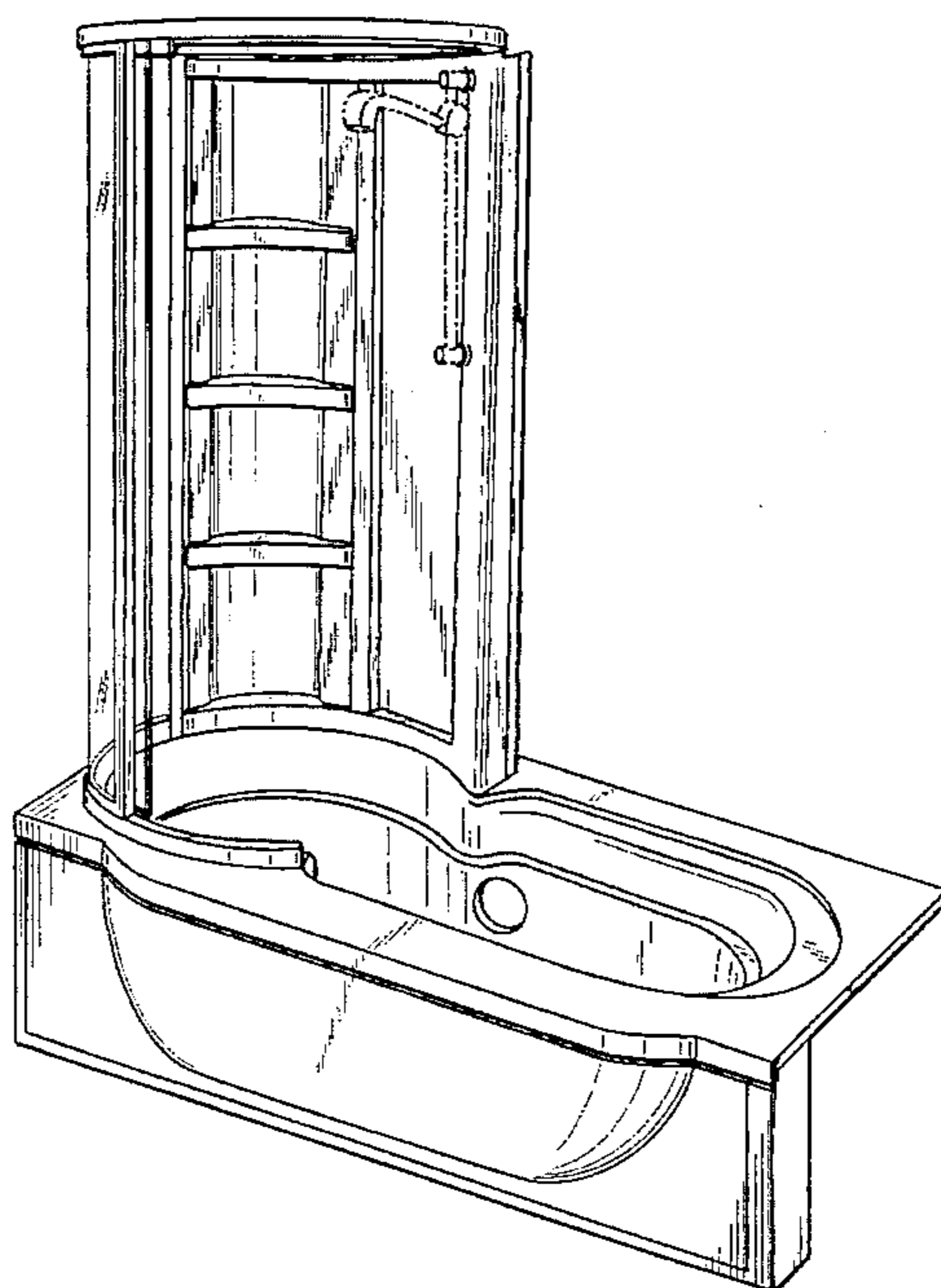

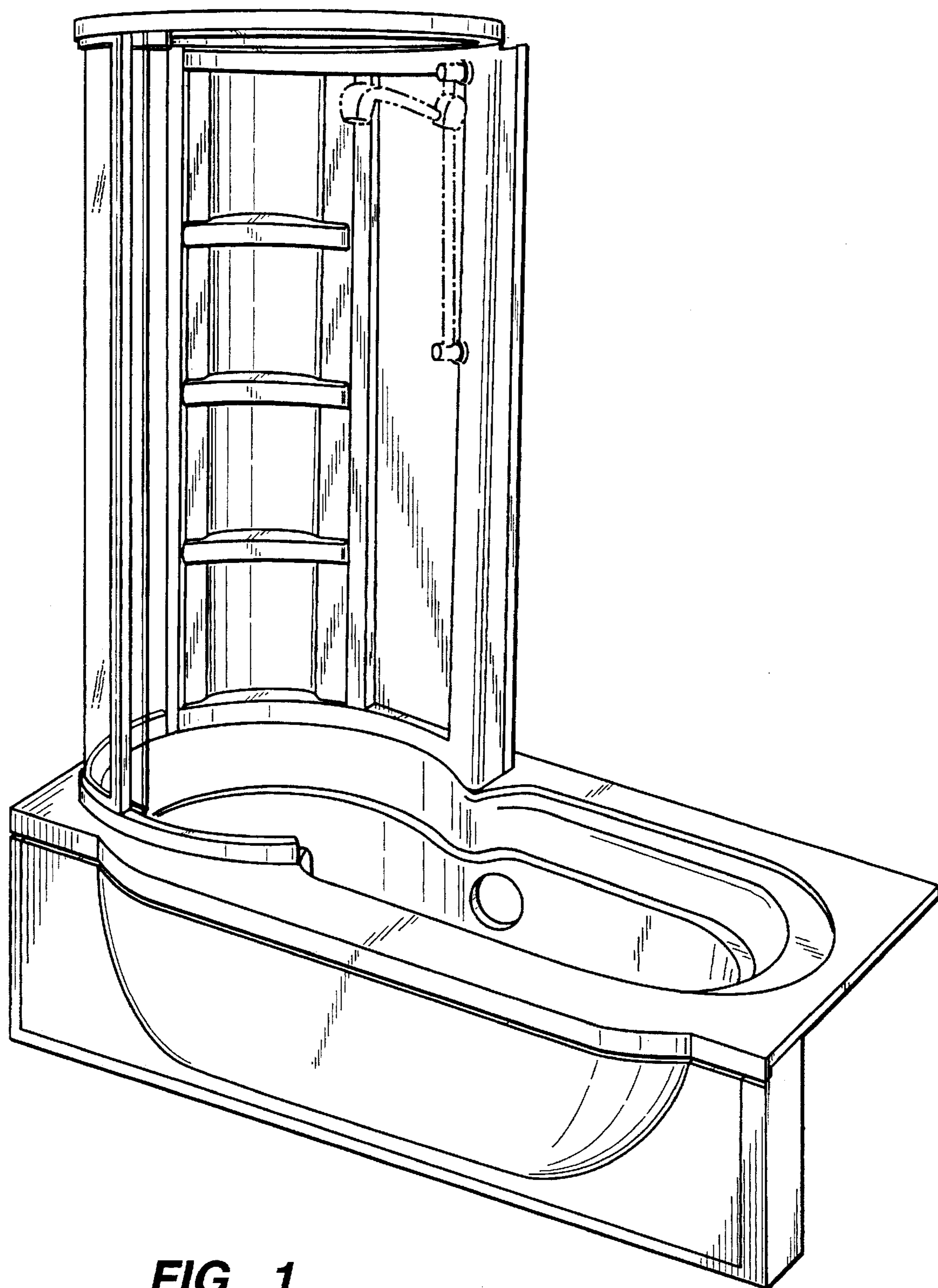

FIG. 1

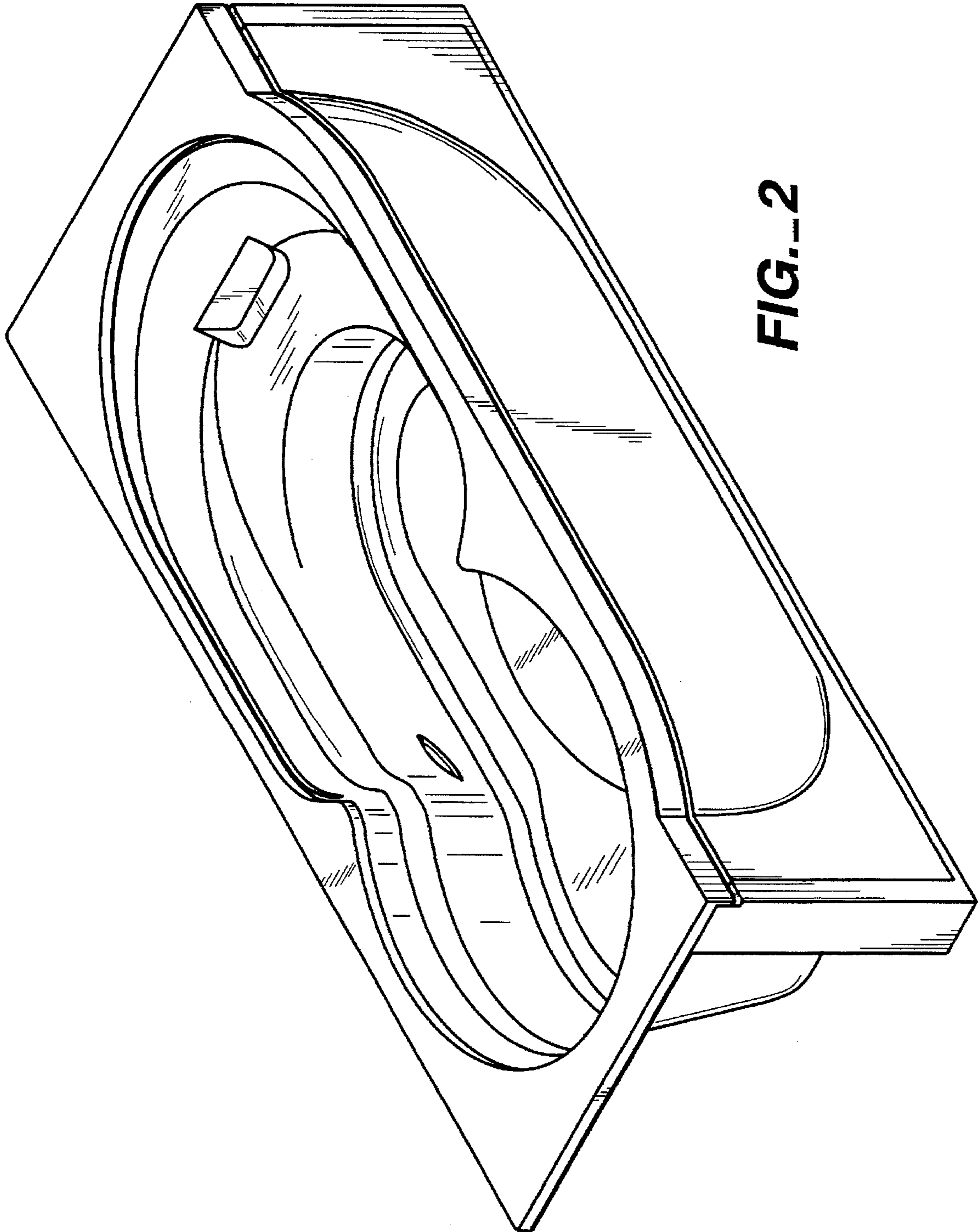

FIG. 2

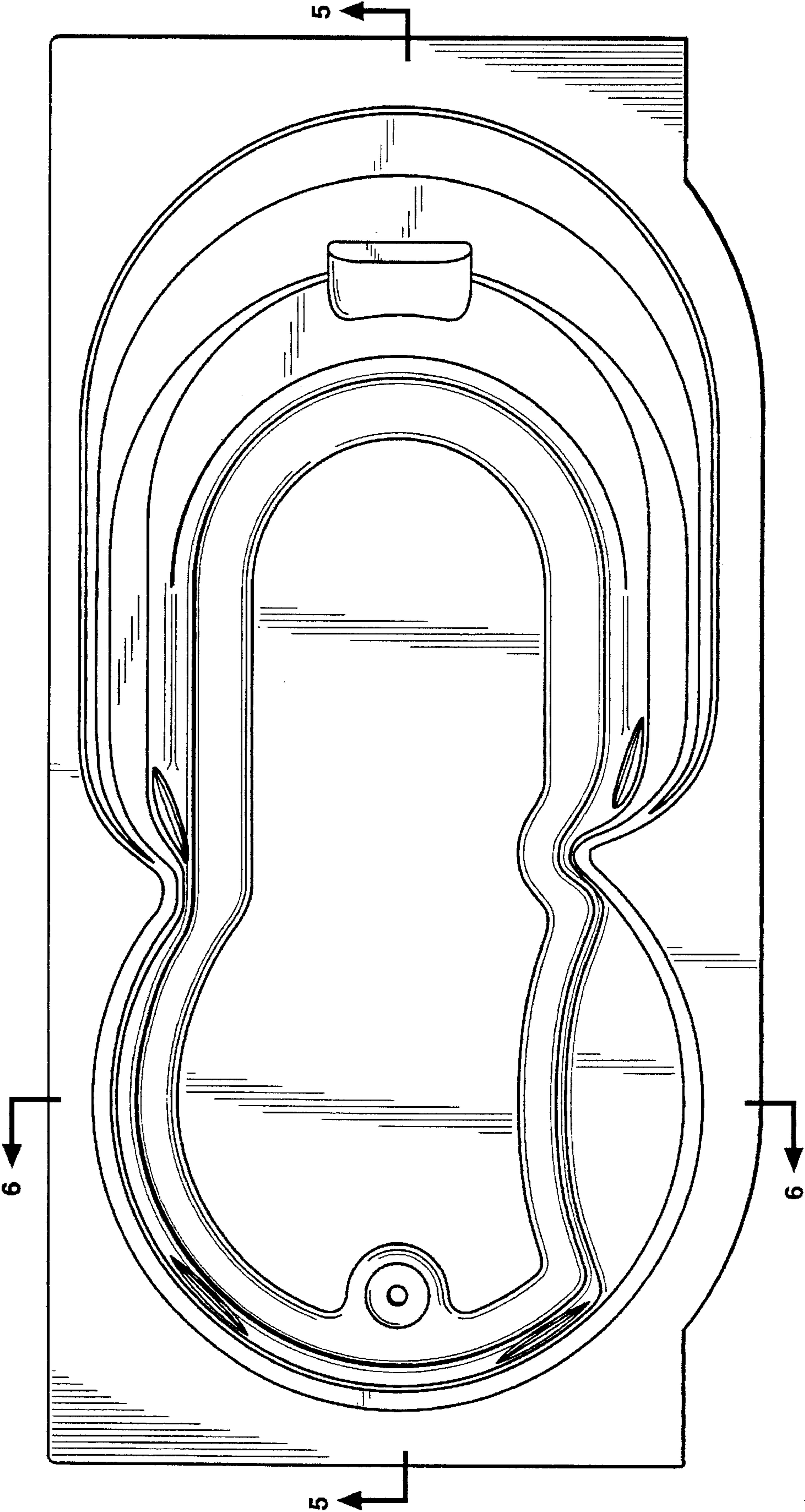

FIG. 3

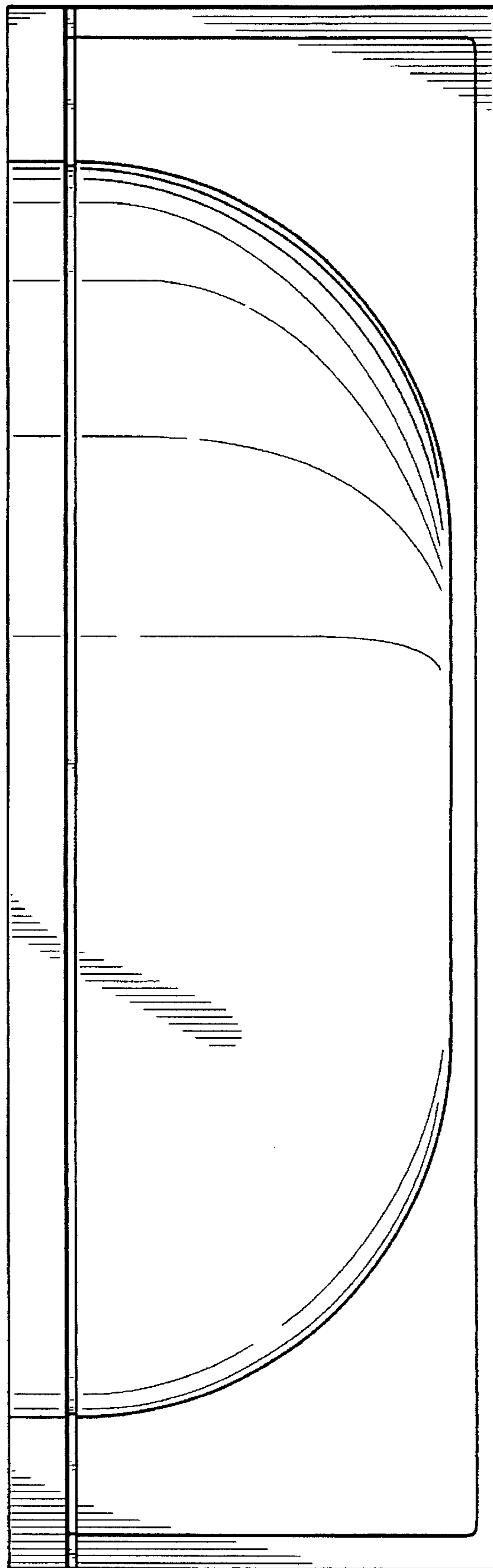

FIG. 4

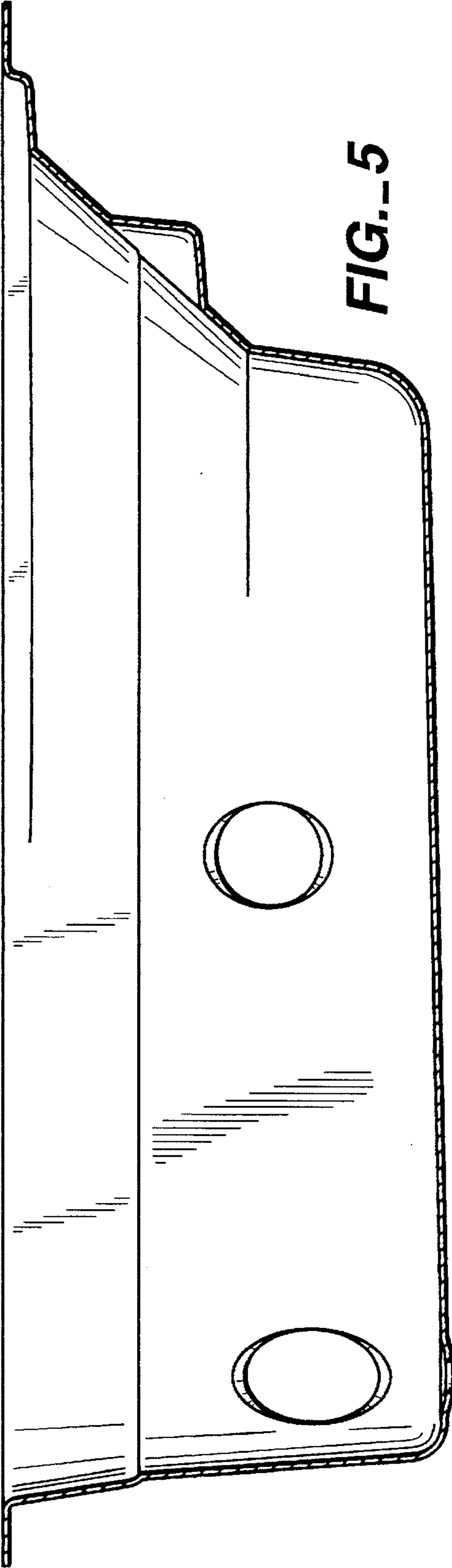

FIG. 5

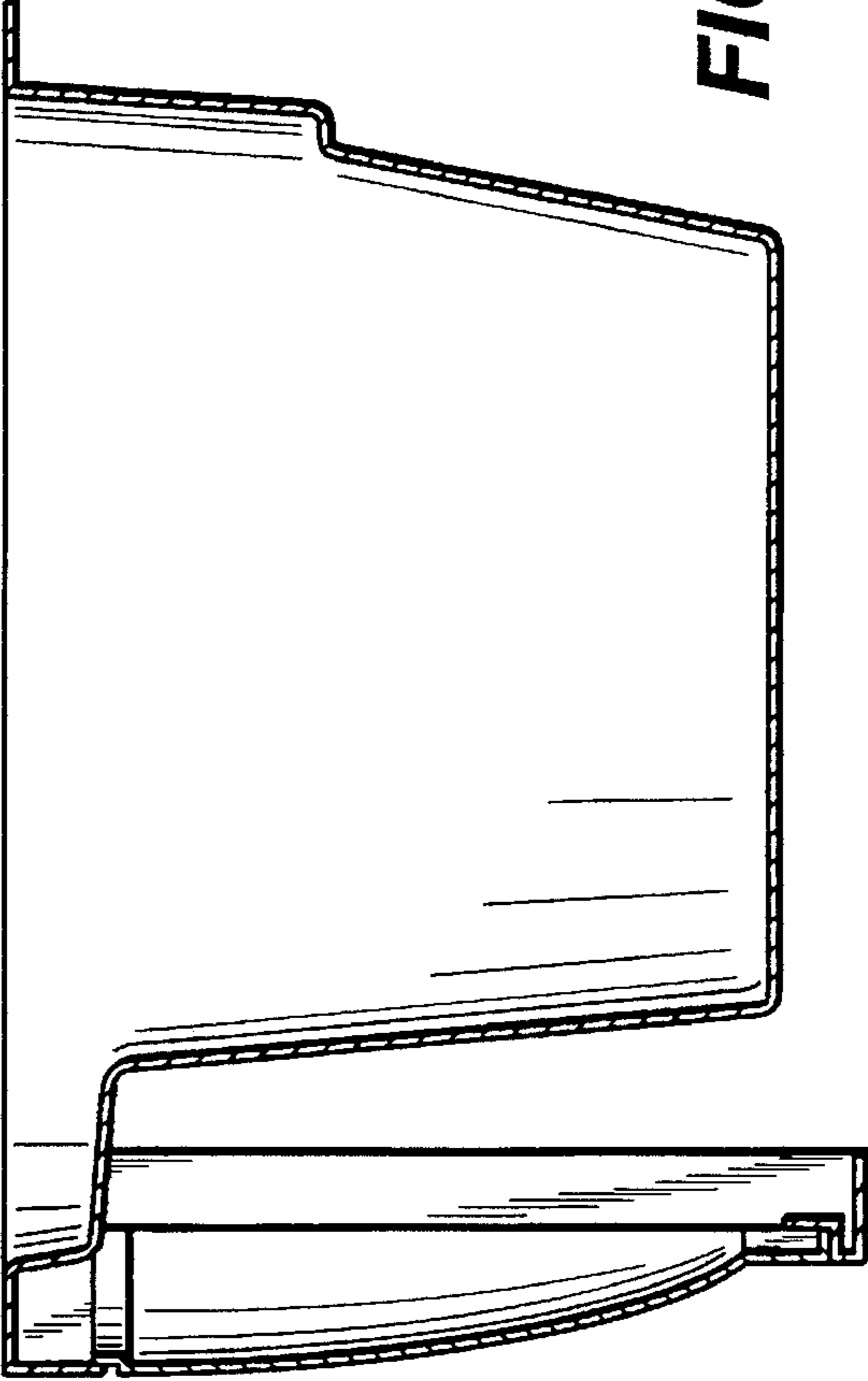

FIG. 6

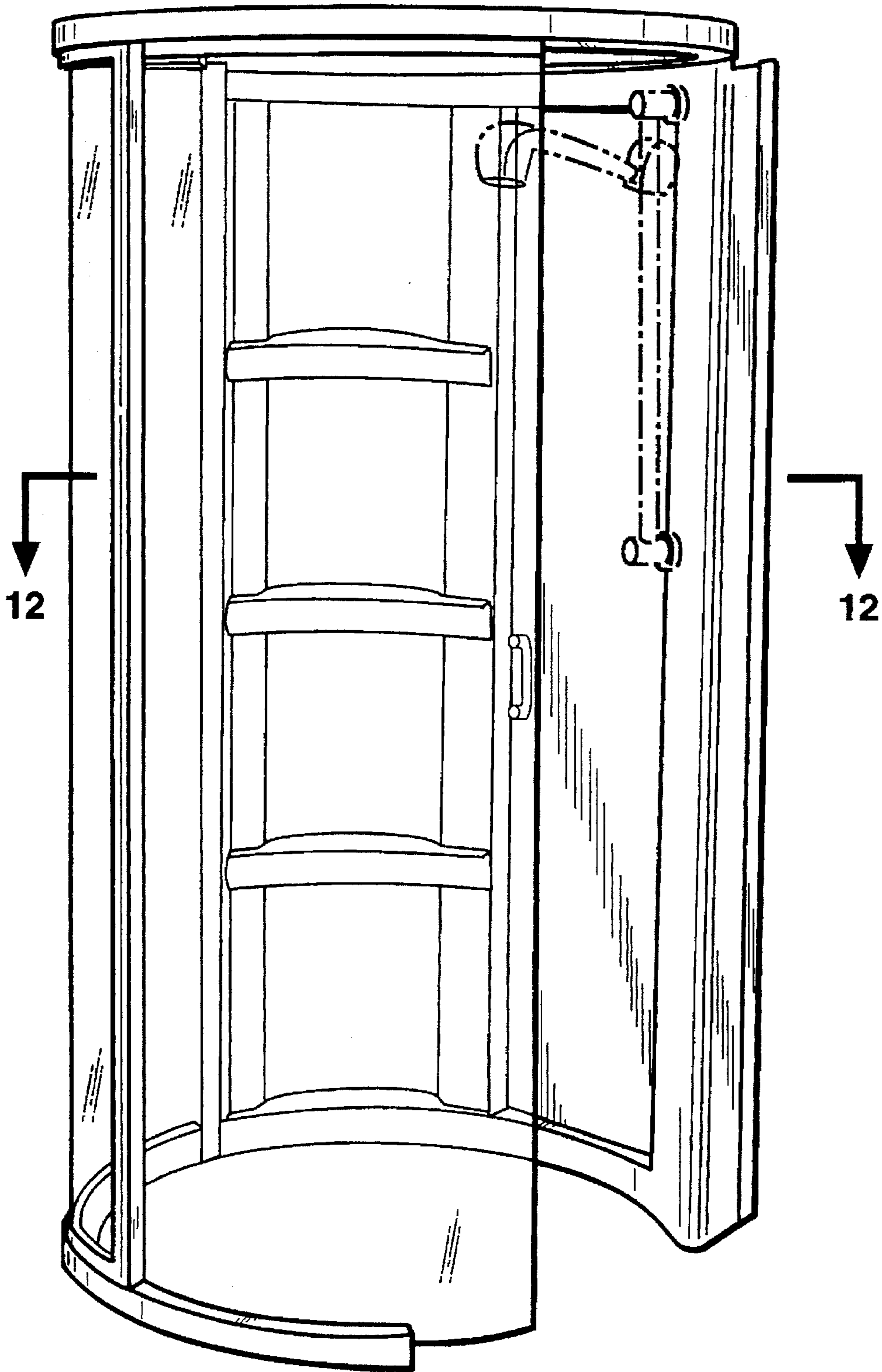

FIG. 7

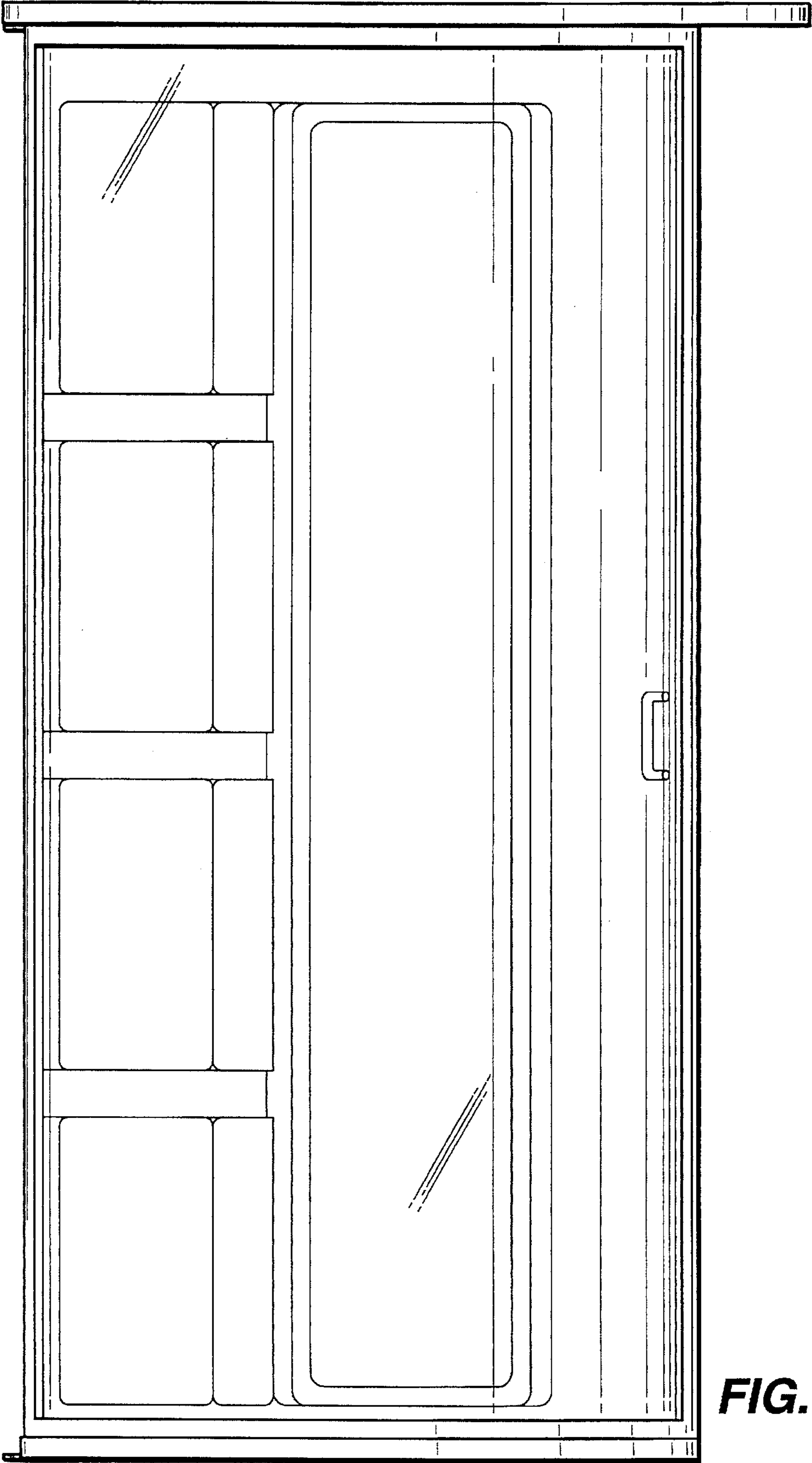

FIG. 8

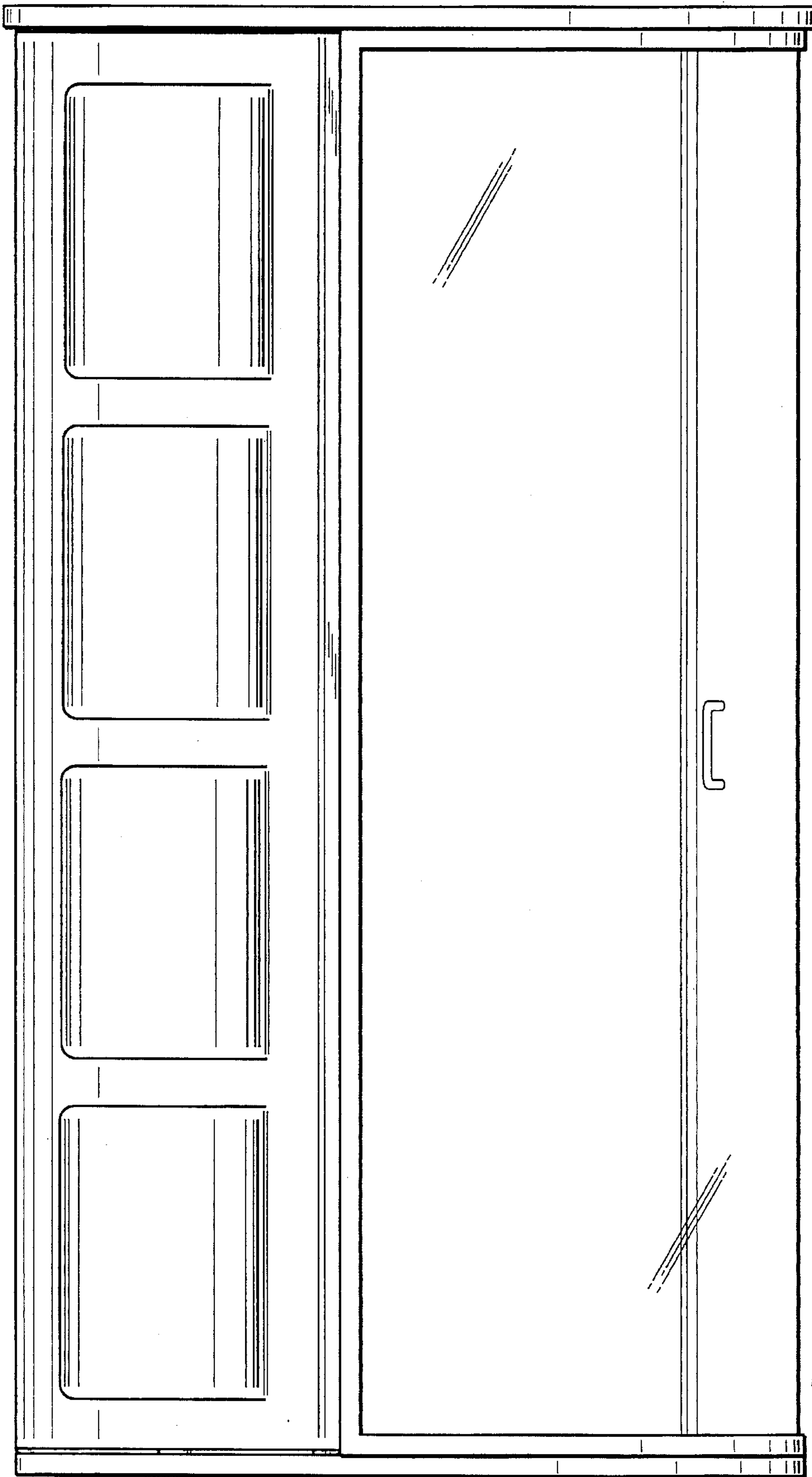

FIG. 9

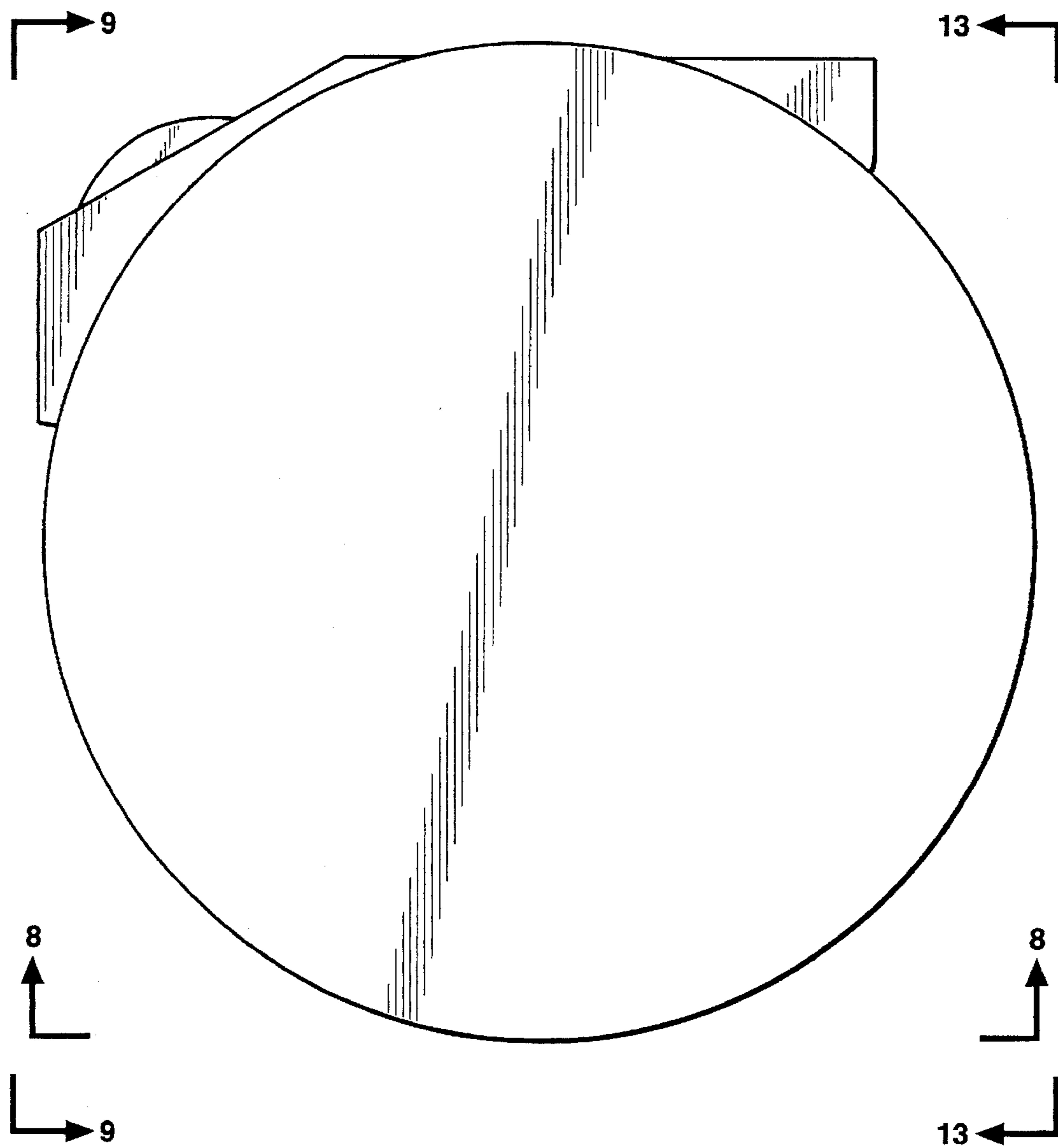

FIG. 10

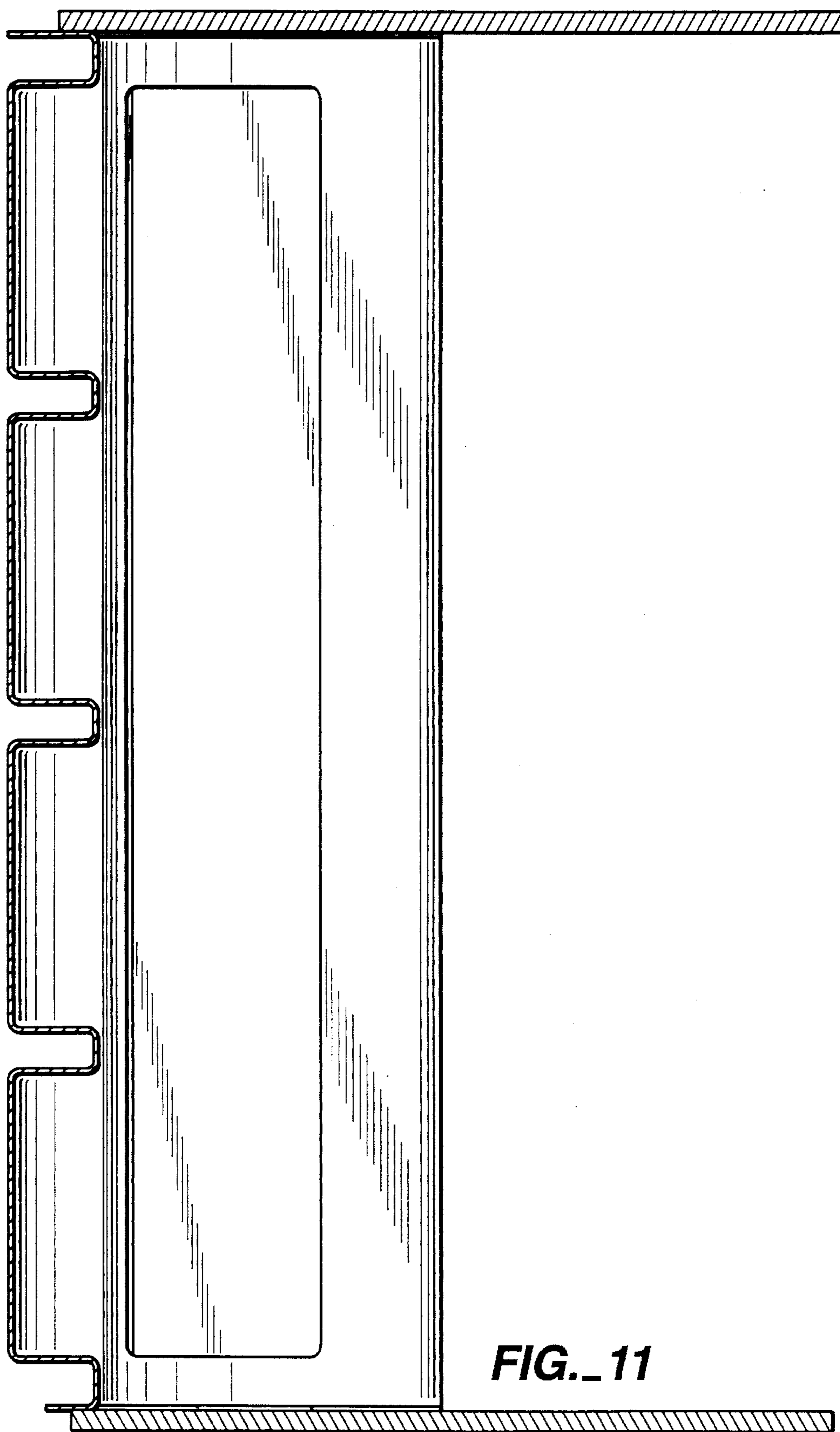

FIG. 11

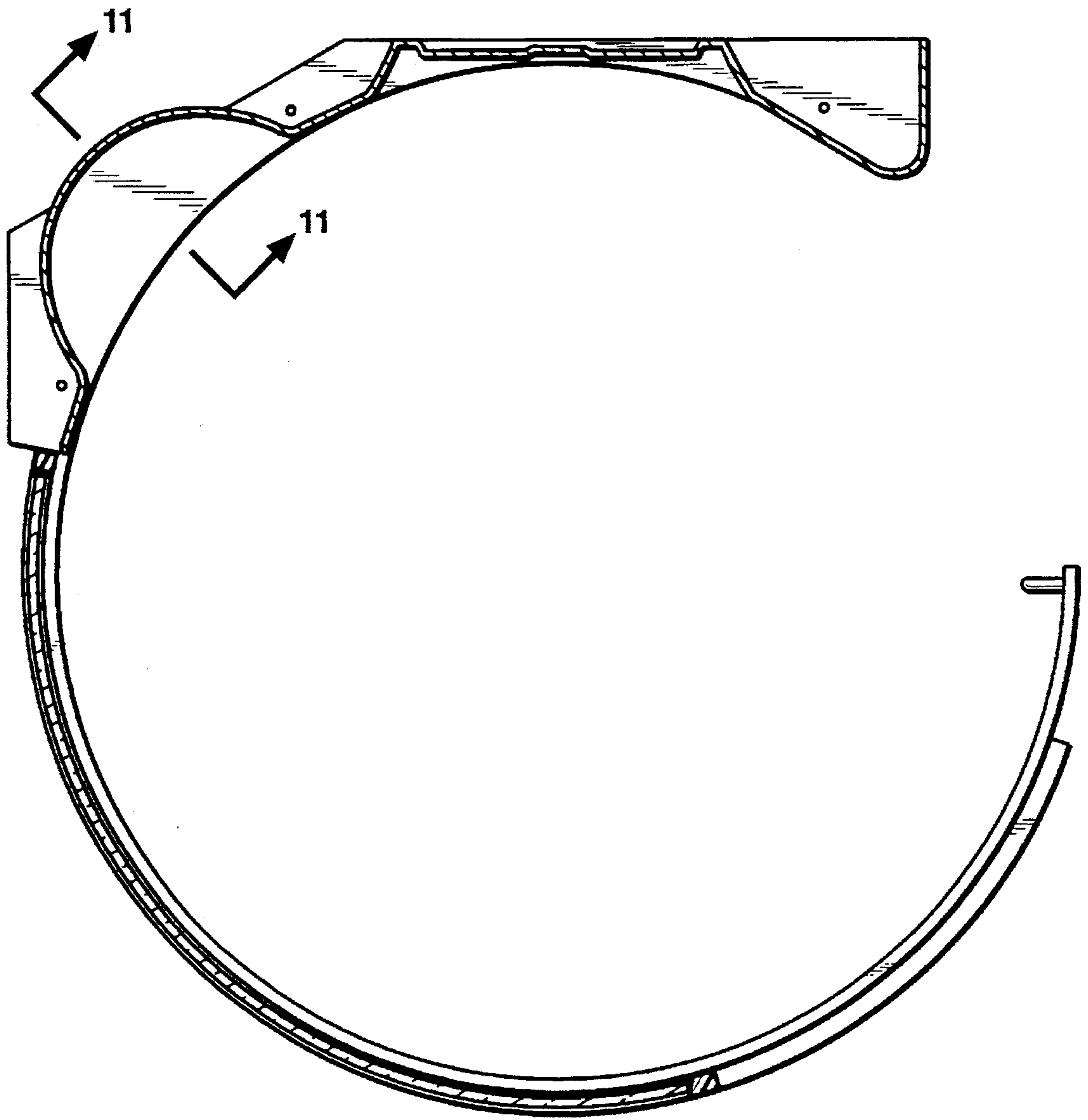

FIG. 12

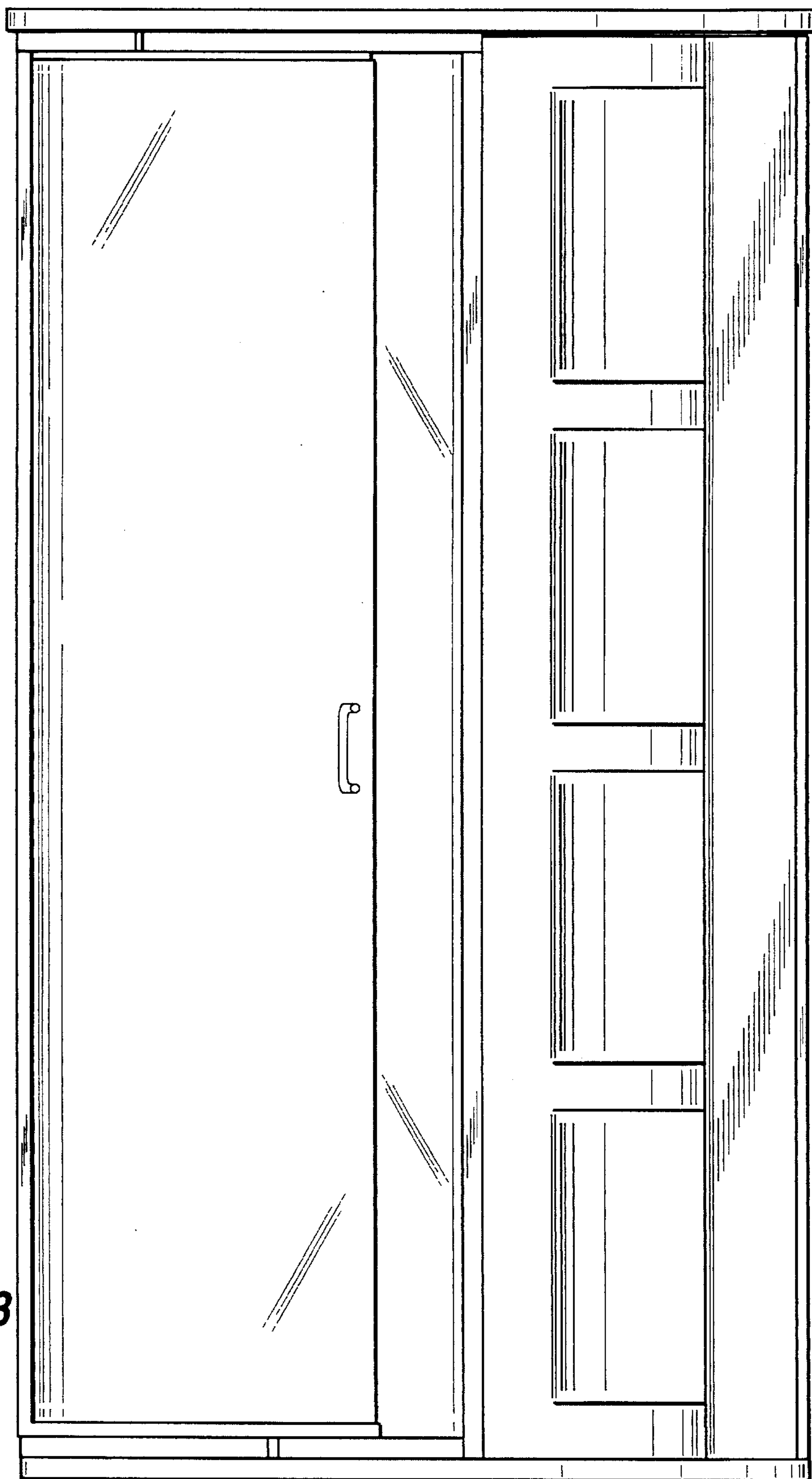

FIG. 13