



US00D383172S

**United States Patent** [19]  
**Allegre**

[11] **Patent Number:** **Des. 383,172**

[45] **Date of Patent:** **\*\*Sep. 2, 1997**

[54] **MOBILE FOR THE EARLY LEARNING OF BABIES**

D. 213,982 4/1969 Simon ..... D11/141 X  
D. 282,383 1/1986 Nakao et al. .... D21/63  
4,756,109 7/1988 Marcus ..... 40/613

[75] **Inventor:** **Jean-Paul Allegre**, Saint-Etienne, France

*Primary Examiner*—Dominic Simone  
*Attorney, Agent, or Firm*—Eckert Seamans Cherin & Mellott

[73] **Assignee:** **Allegre Puericulture Hygiene S.A.**, France

[\*\*] **Term:** **14 Years**

[57] **CLAIM**

[21] **Appl. No.:** **45,903**

The ornamental design for a mobile for the early learning of babies, as shown and described.

[22] **Filed:** **Nov. 2, 1995**

**DESCRIPTION**

[30] **Foreign Application Priority Data**

May 2, 1995 [FR] France ..... 952.668

FIG. 1 is a front perspective view of a mobile for the early learning of babies, showing my new design;

[51] **LOC (6) Cl.** ..... **21-01**

FIG. 2 is a top plan view thereof;

[52] **U.S. Cl.** ..... **D21/63; D21/62**

FIG. 3 is a front elevational view thereof;

[58] **Field of Search** ..... **D21/59, 62-65;**

FIG. 4 is a left side elevational view thereof;

**D11/141; 40/613, 614, 617; 446/227**

FIG. 5 is a right side elevational view thereof;

FIG. 6 is a rear elevational view thereof; and,

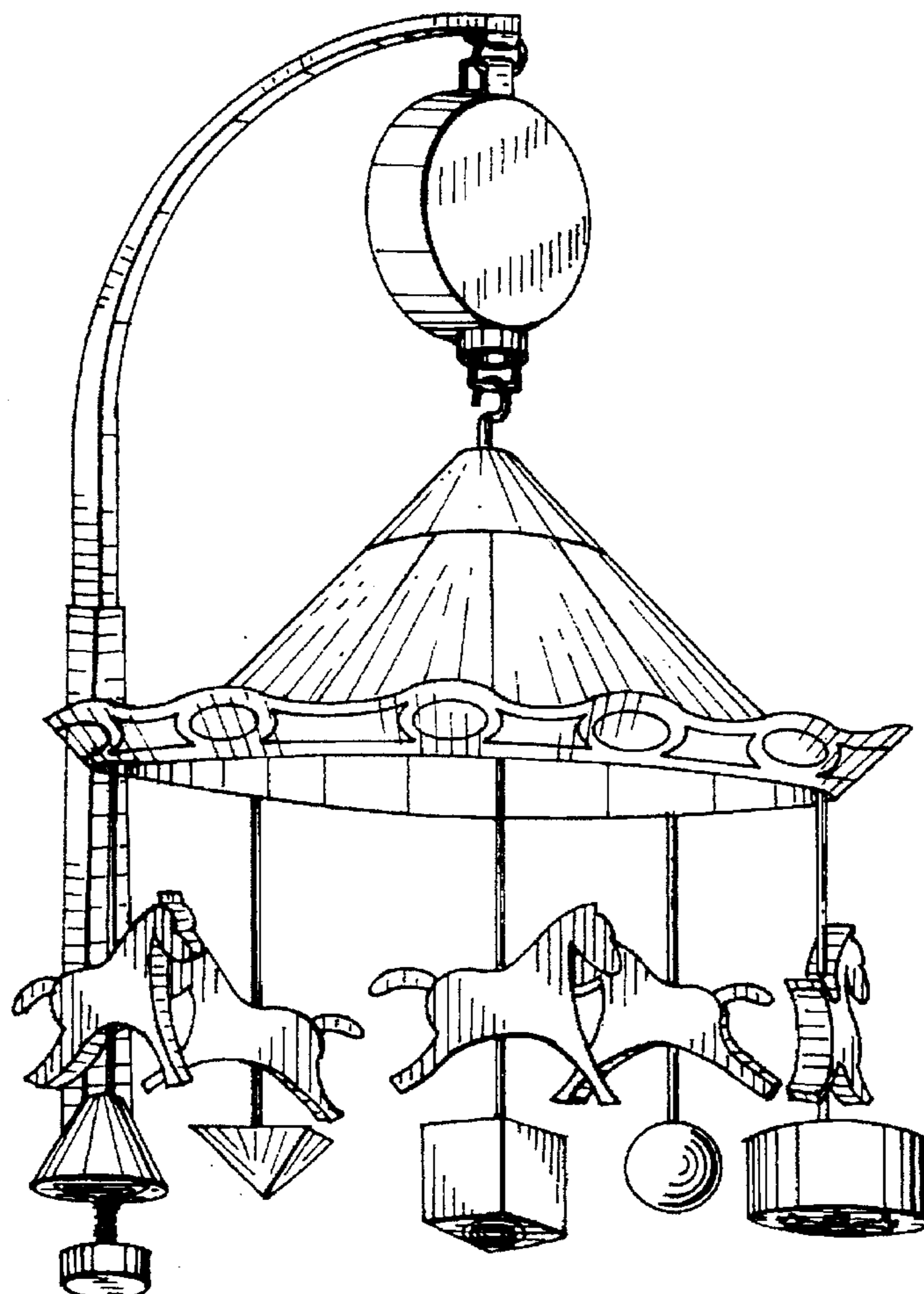
FIG. 7 is a bottom plan view thereof.

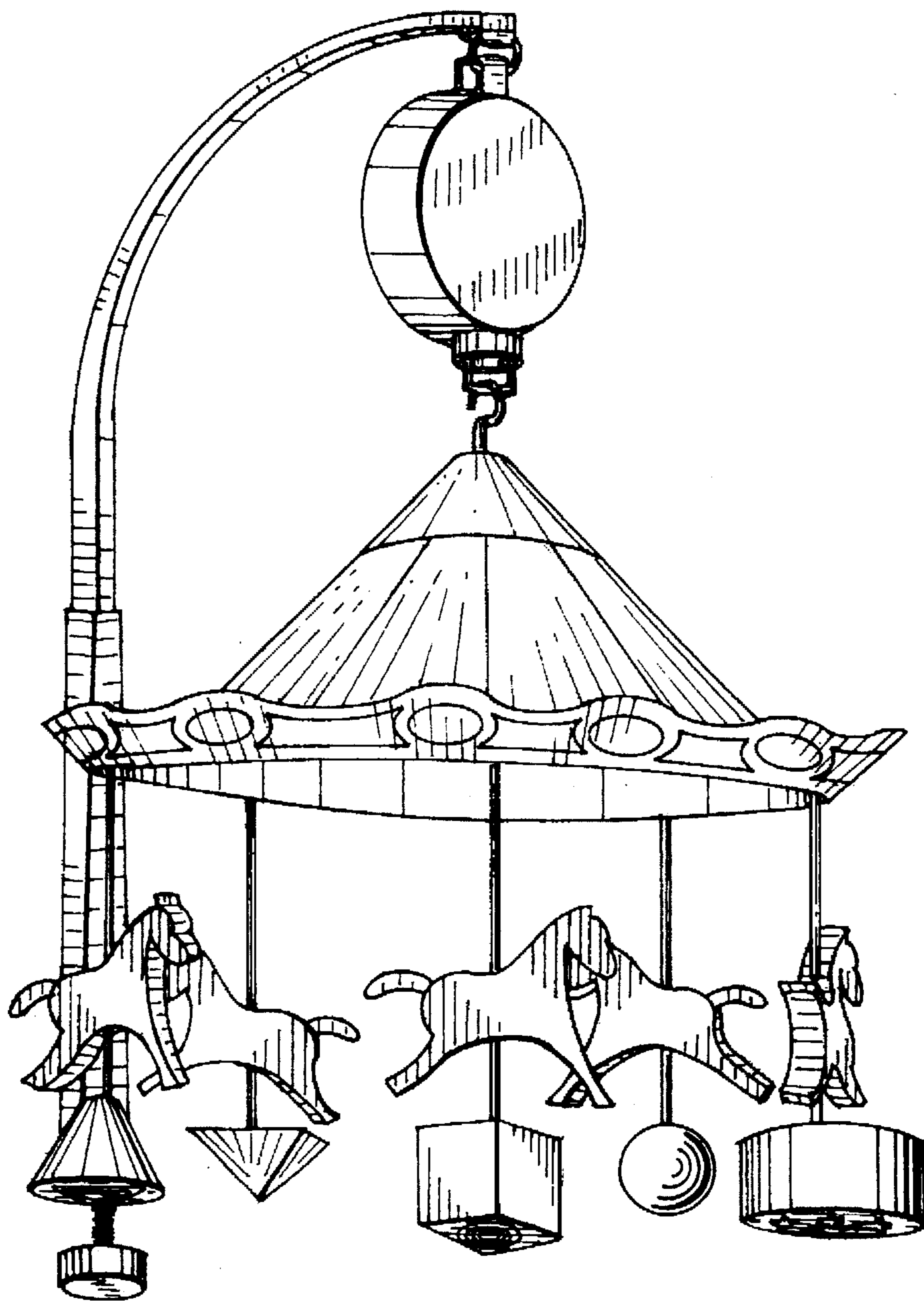
[56] **References Cited**

**U.S. PATENT DOCUMENTS**

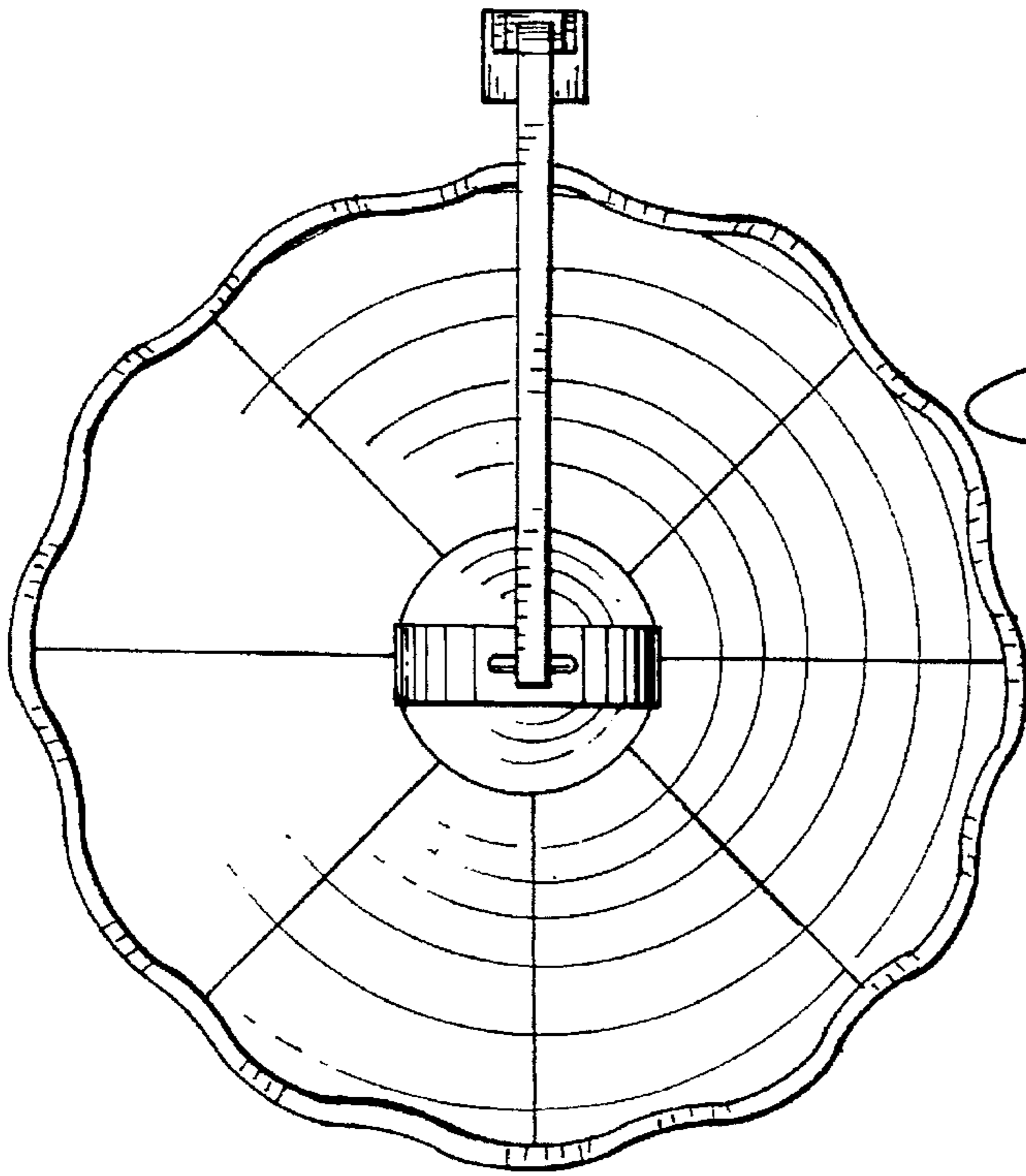
D. 169,423 4/1953 Cheresh ..... D21/62

**1 Claim, 4 Drawing Sheets**

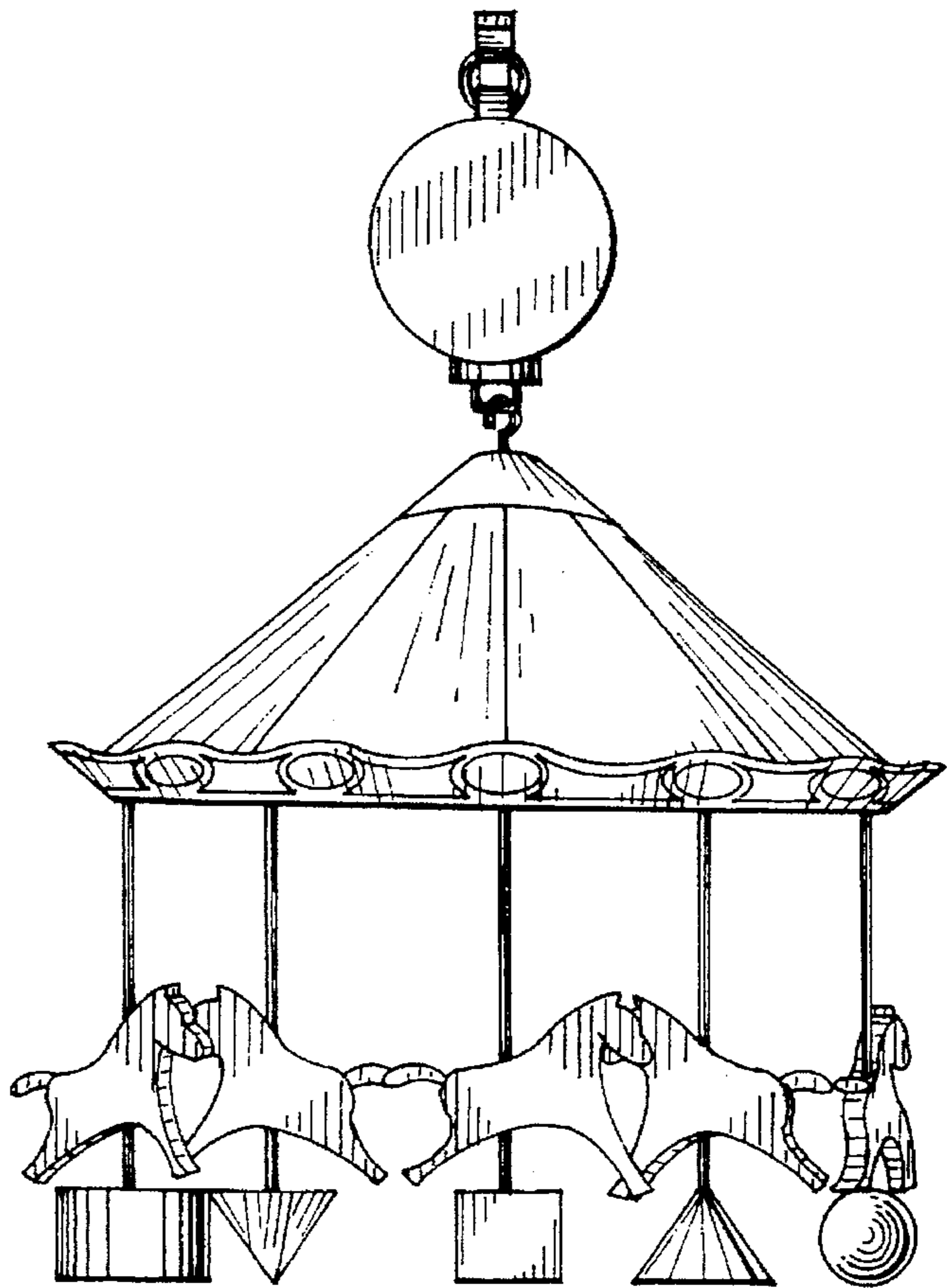




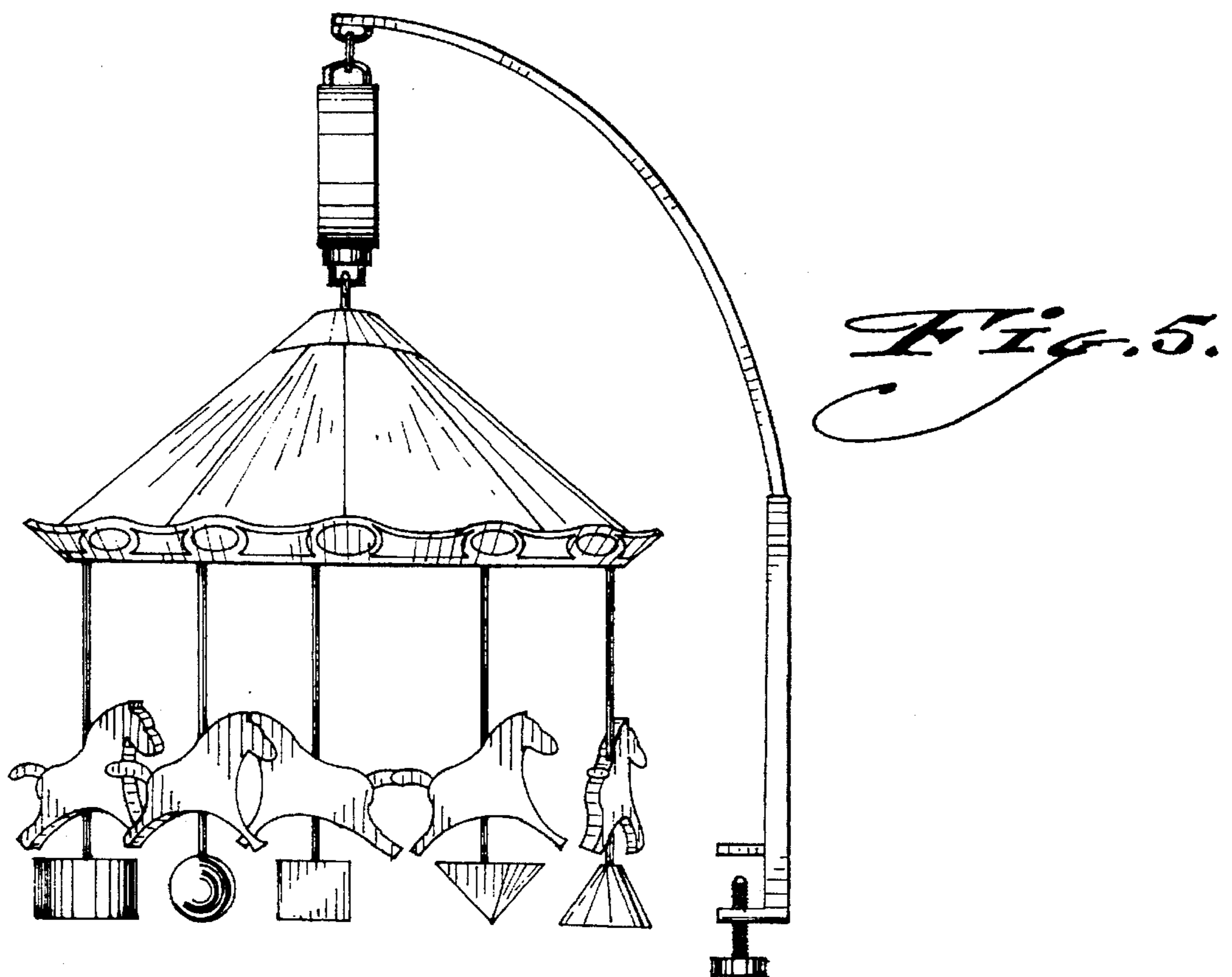
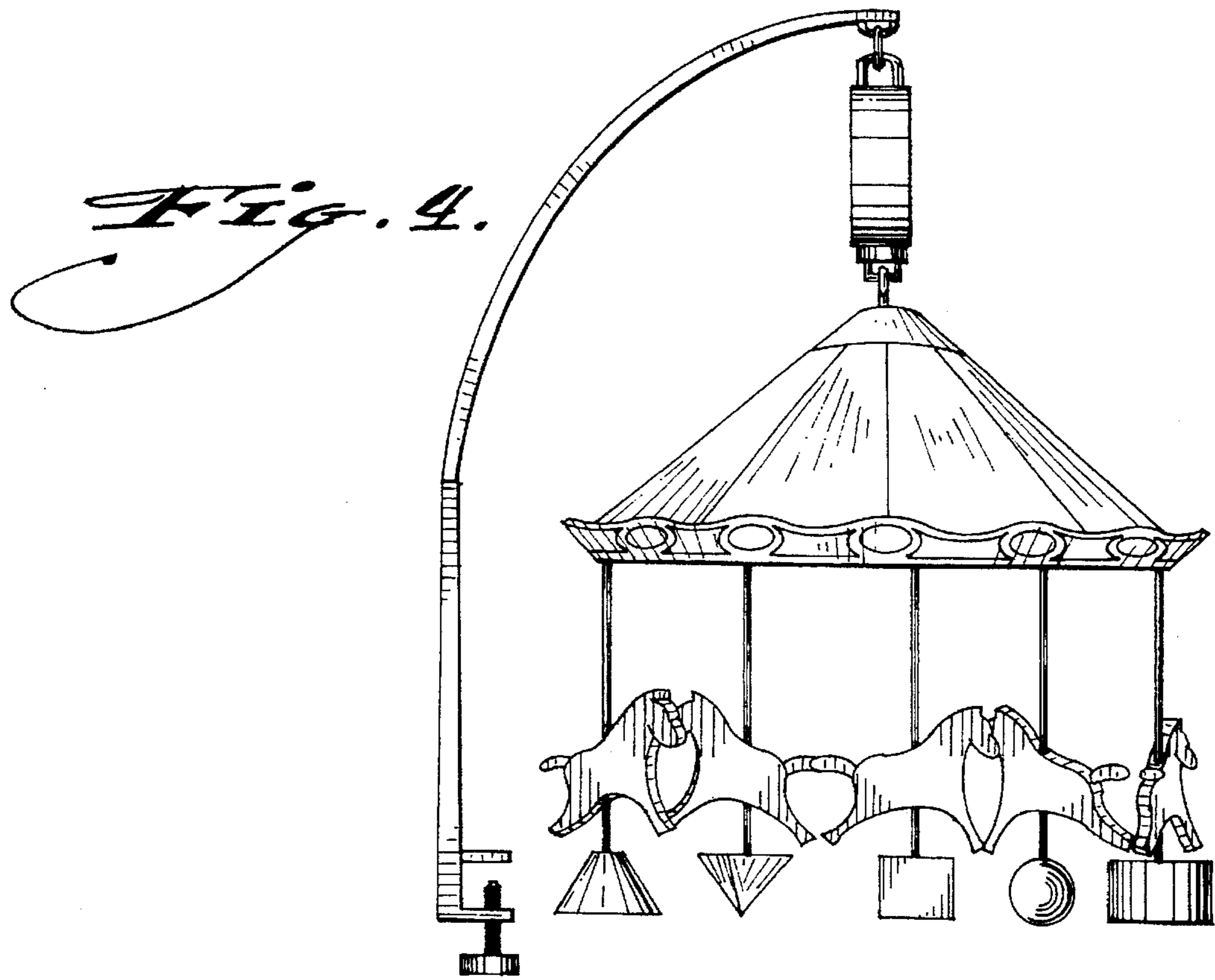
*Fig. 1.*



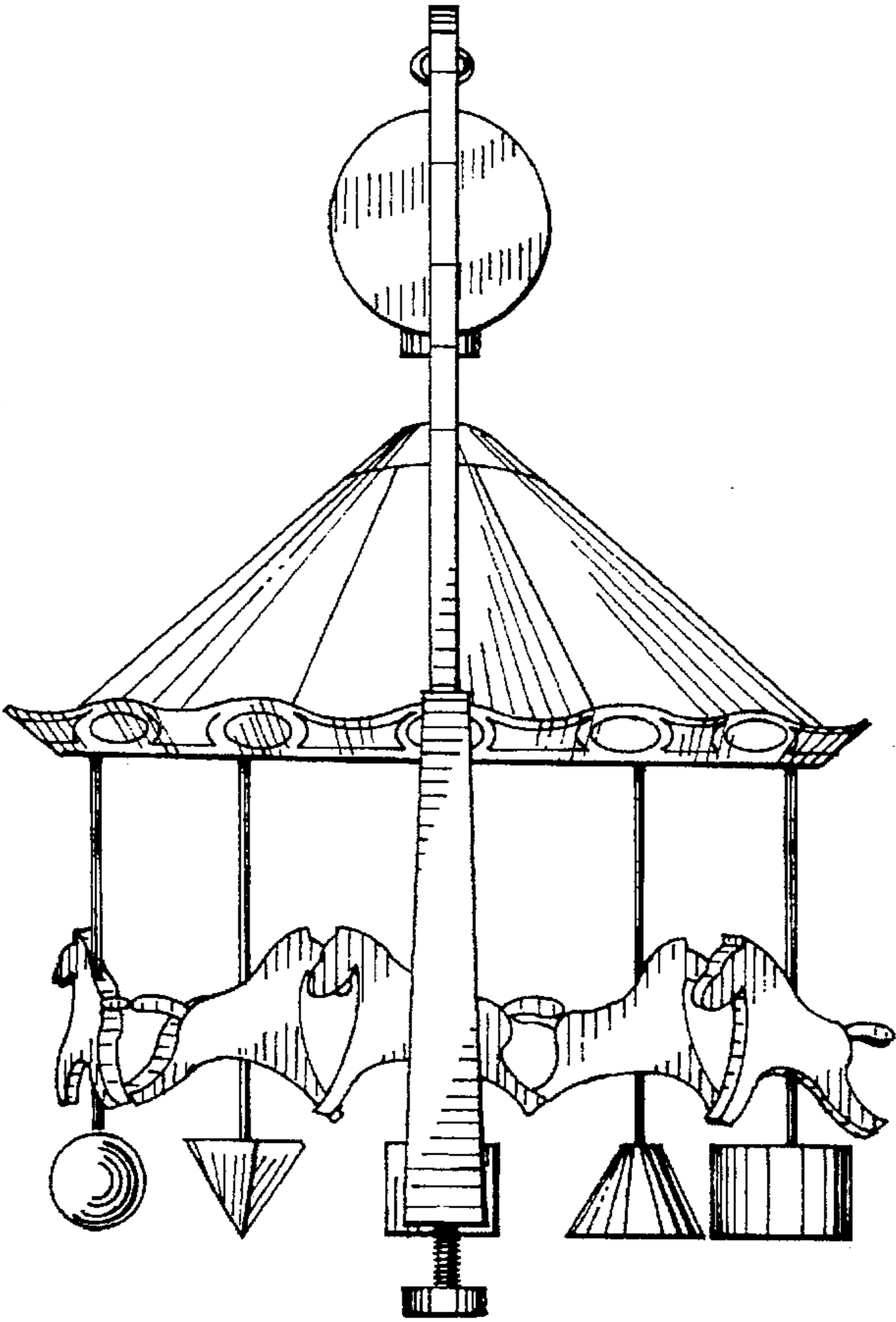
*Fig. 2.*



*Fig. 3.*



*Fig. 6.*



*Fig. 7.*

