



US00D383118S

United States Patent [19]
Chen

[11] **Patent Number: Des. 383,118**

[45] **Date of Patent: **Sep. 2, 1997**

[54] **COMBINED SUPPORT AND ELECTRICAL RECEPTACLE**

Primary Examiner—Holly Baynham
Attorney, Agent, or Firm—Bacon & Thomas

[76] **Inventor: Chih-Ching Chen**, No. 5, Sublane 2, Lane 24, Hua Yin Street, Taipei, Taiwan

[57] **CLAIM**

[**] **Term: 14 Years**

The ornamental design for a combined support and electrical receptacle, as shown and described.

[21] **Appl. No.: 53,644**

DESCRIPTION

[22] **Filed: Apr. 26, 1996**

FIG. 1 is a perspective view of a combined support and electrical receptacle showing my design;
FIG. 2 is a front elevational view thereof;
FIG. 3 is a rear elevational view thereof;
FIG. 4 is a left side elevational view thereof;
FIG. 5 is a right side elevational view thereof;
FIG. 6 is a top plan view thereof;
FIG. 7 is a bottom plan view thereof; and,
FIG. 8 is a reduced environmental perspective view showing the combined support and electrical receptacle, a rod and a tracklight shown in dotted lines, are for illustrative purposes only and form no part of the claimed design.

[51] **LOC (6) Cl. 13-03**

[52] **U.S. Cl. D13/139**

[58] **Field of Search** D13/134; D8/349, D8/354; D26/138; 248/316.1, 500; 362/226, 427; 174/70 R, 79; 439/527, 574-575

[56] **References Cited**

U.S. PATENT DOCUMENTS

- D. 136,758 11/1943 Casanov D13/119
- D. 300,314 3/1989 Krzyzanowski et al. D13/139
- 927,724 7/1909 Haynes 248/500

1 Claim, 5 Drawing Sheets

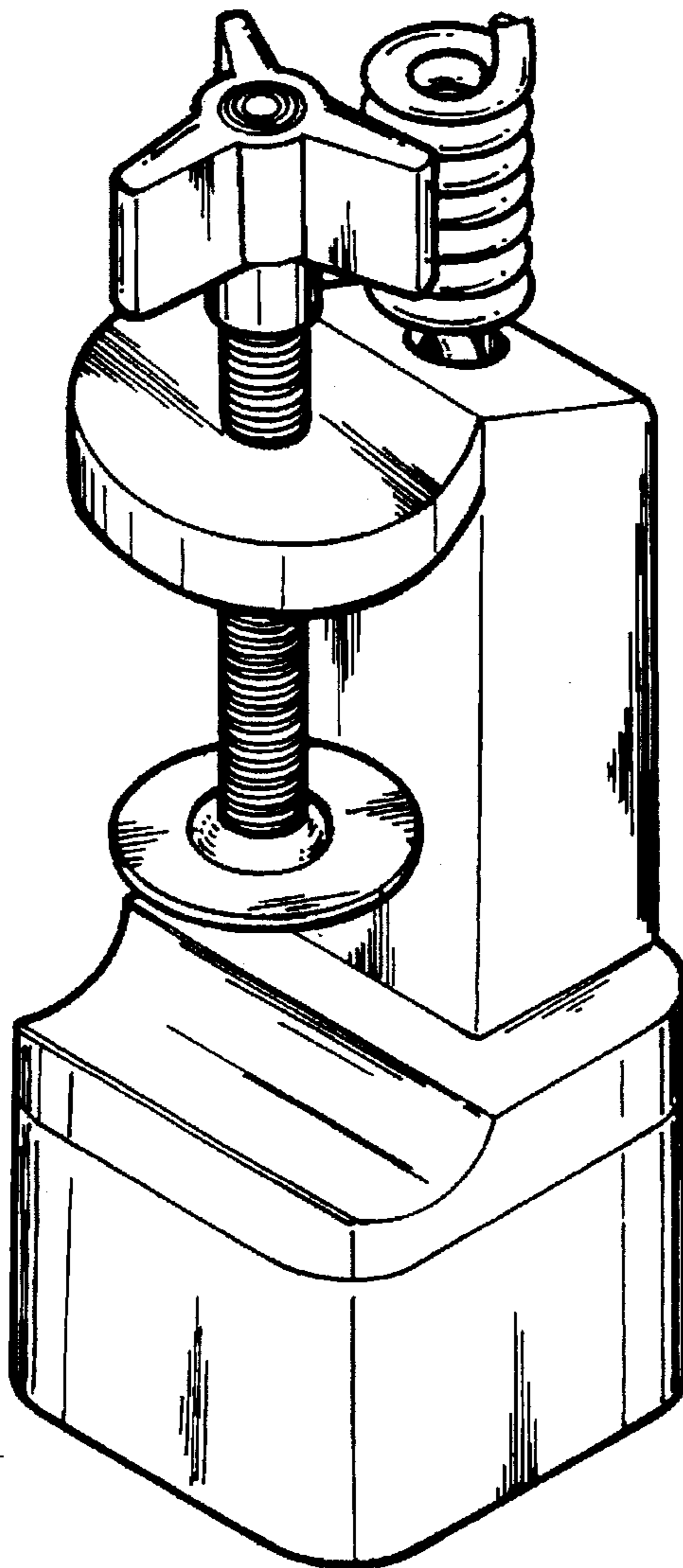

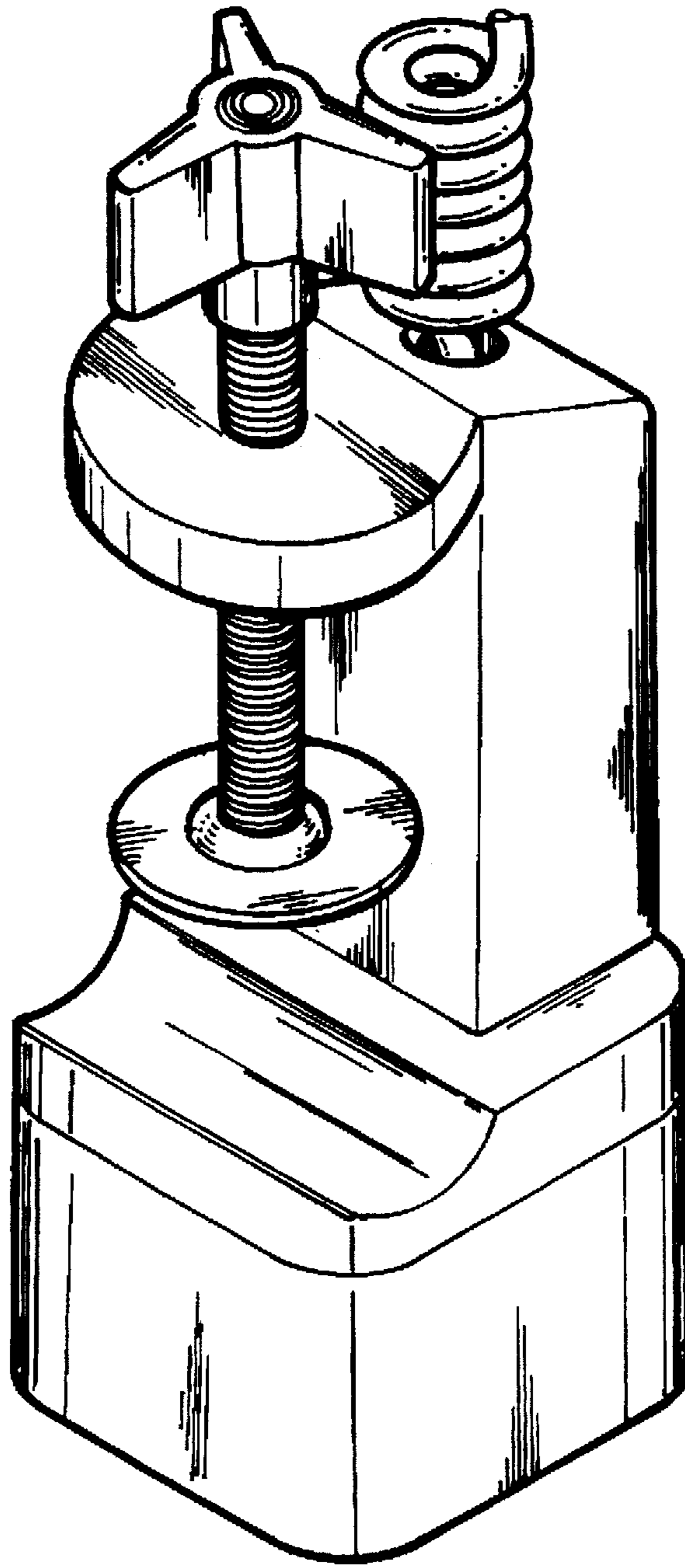

FIG. 1

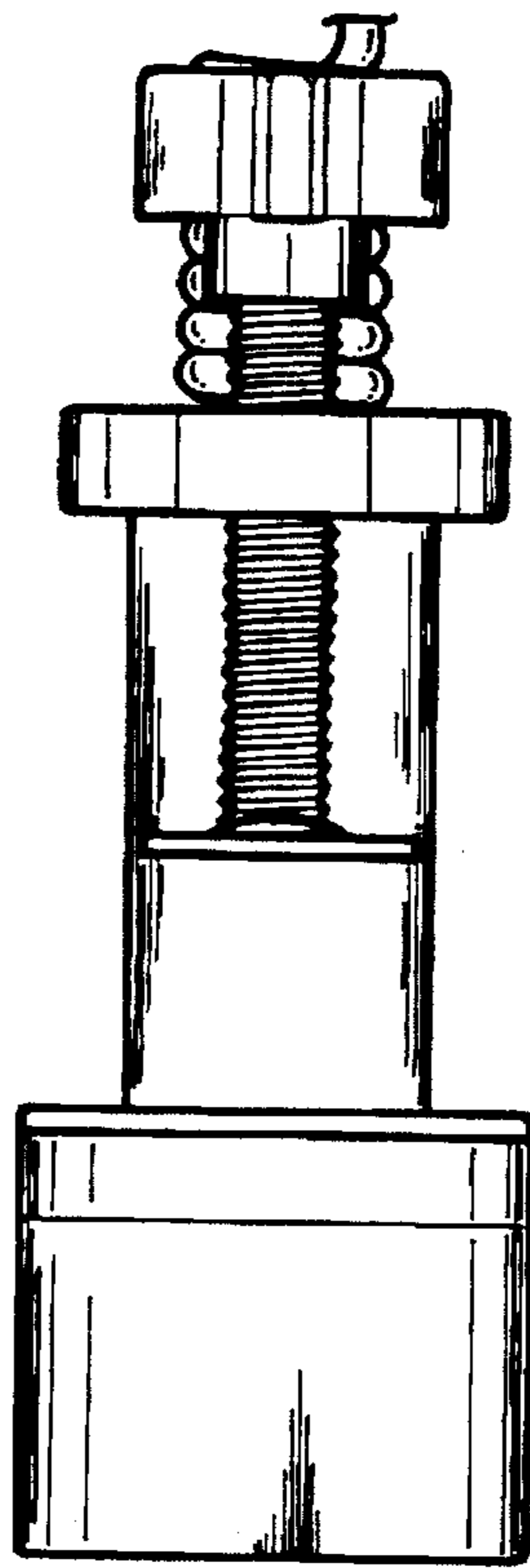

FIG. 2

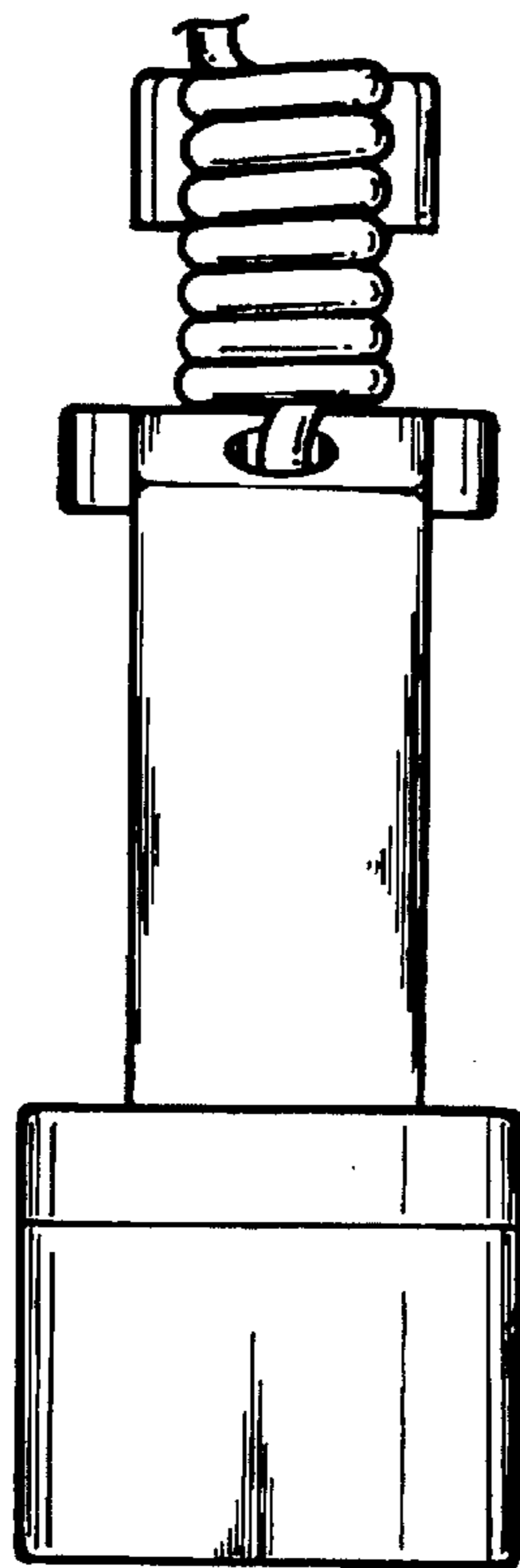

FIG. 3

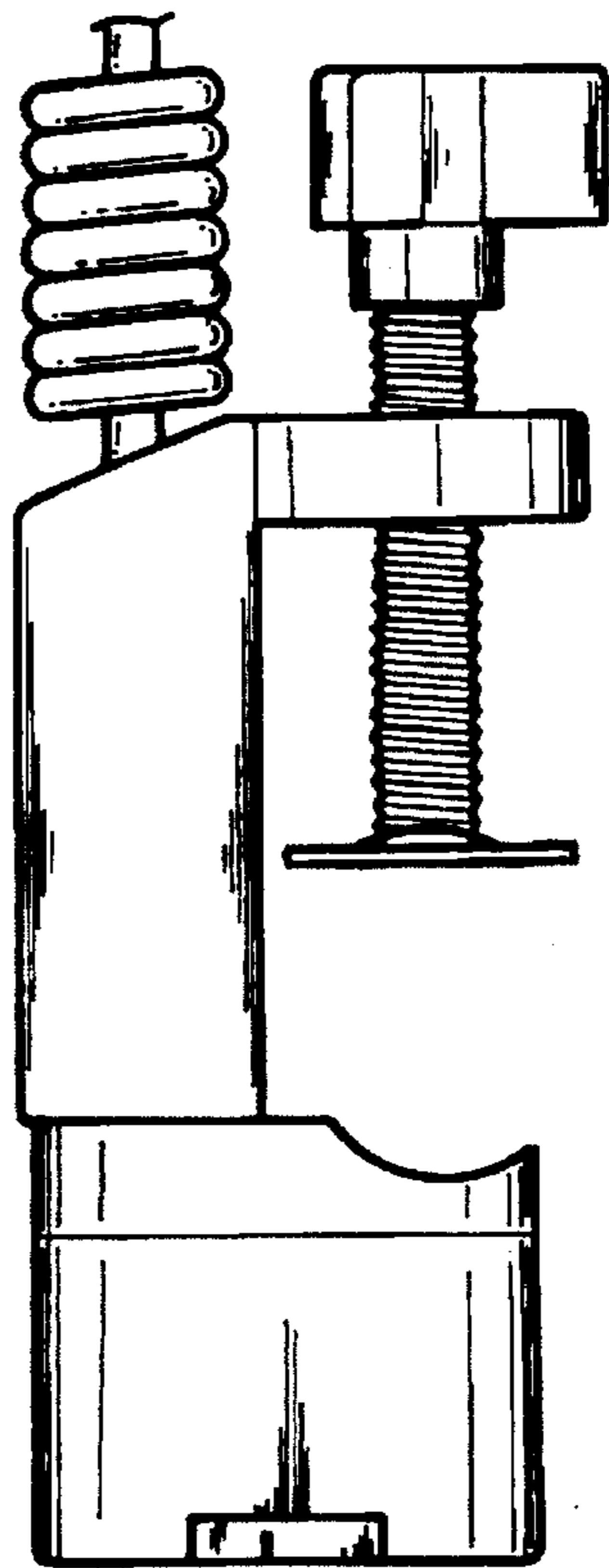

FIG. 4

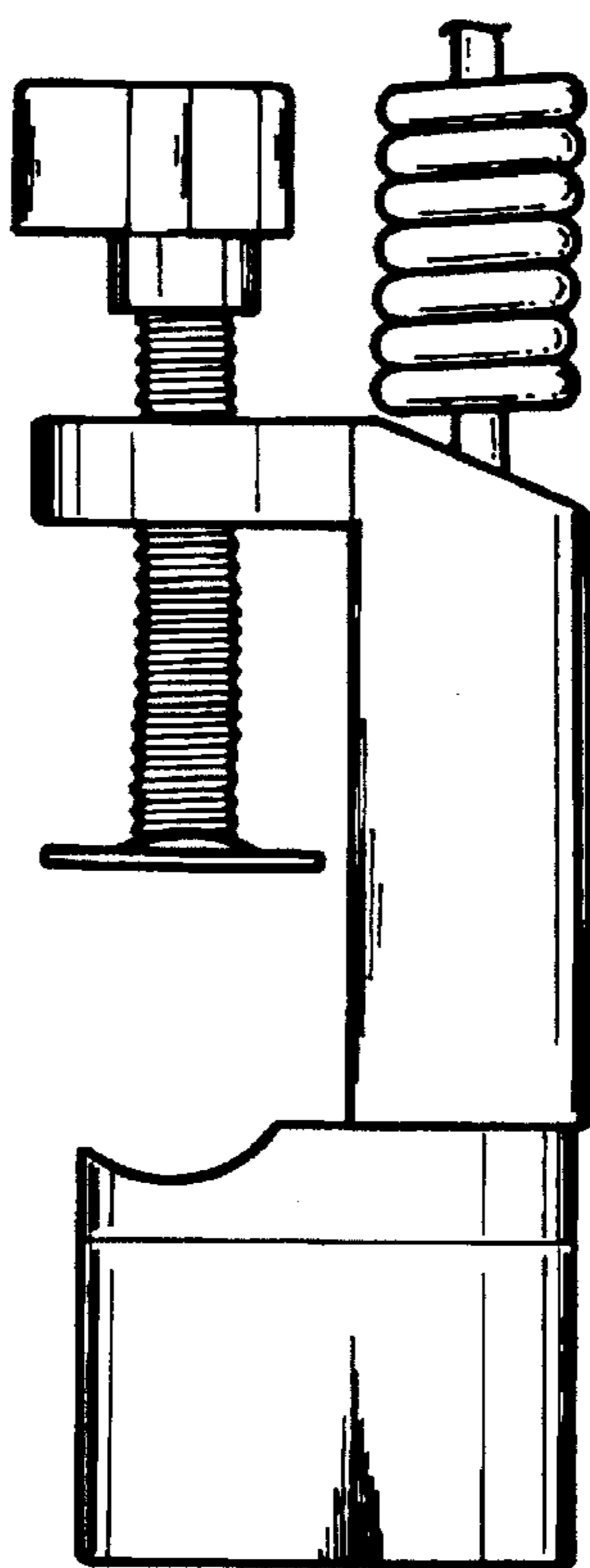

FIG. 5

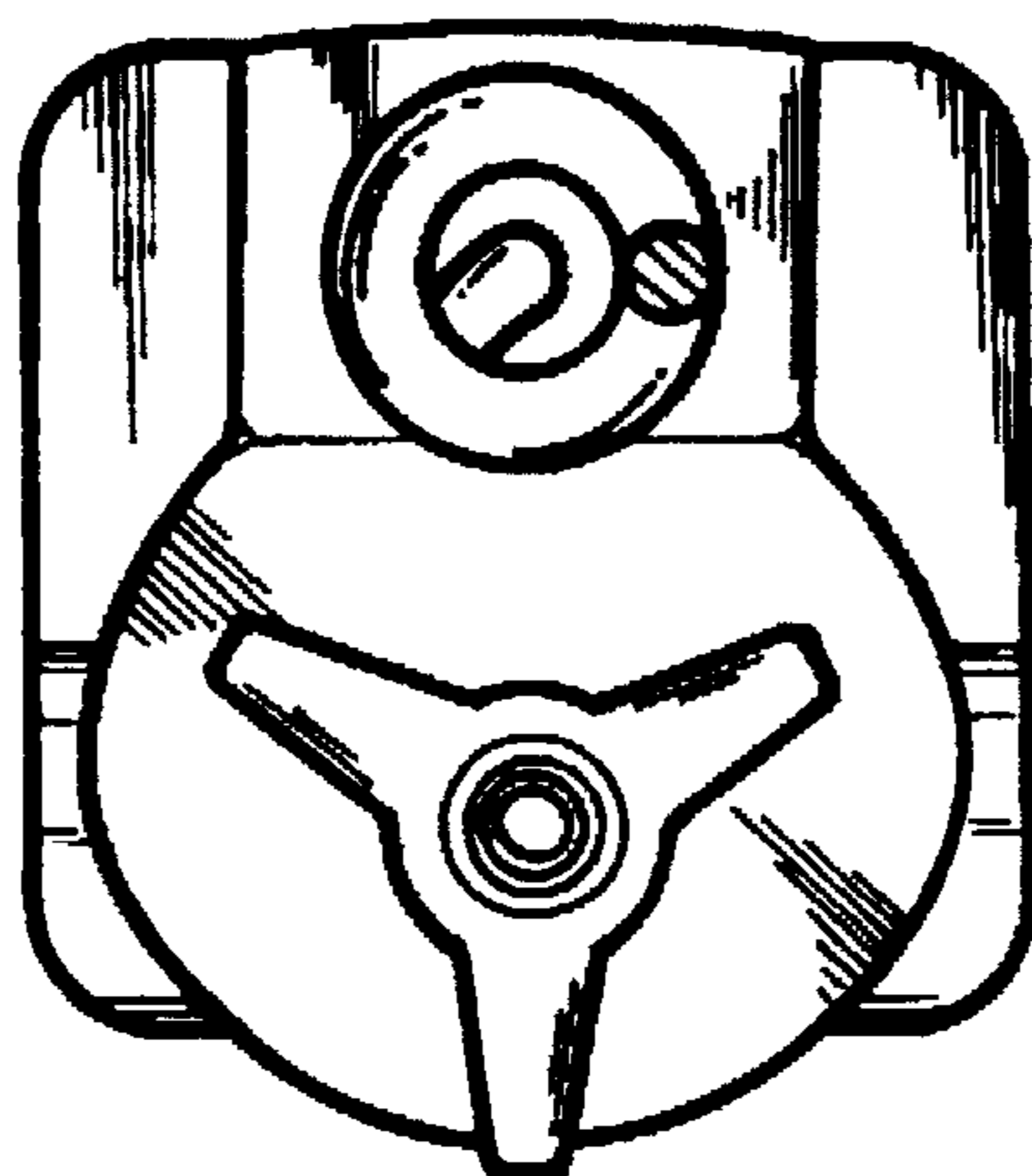

FIG. 6

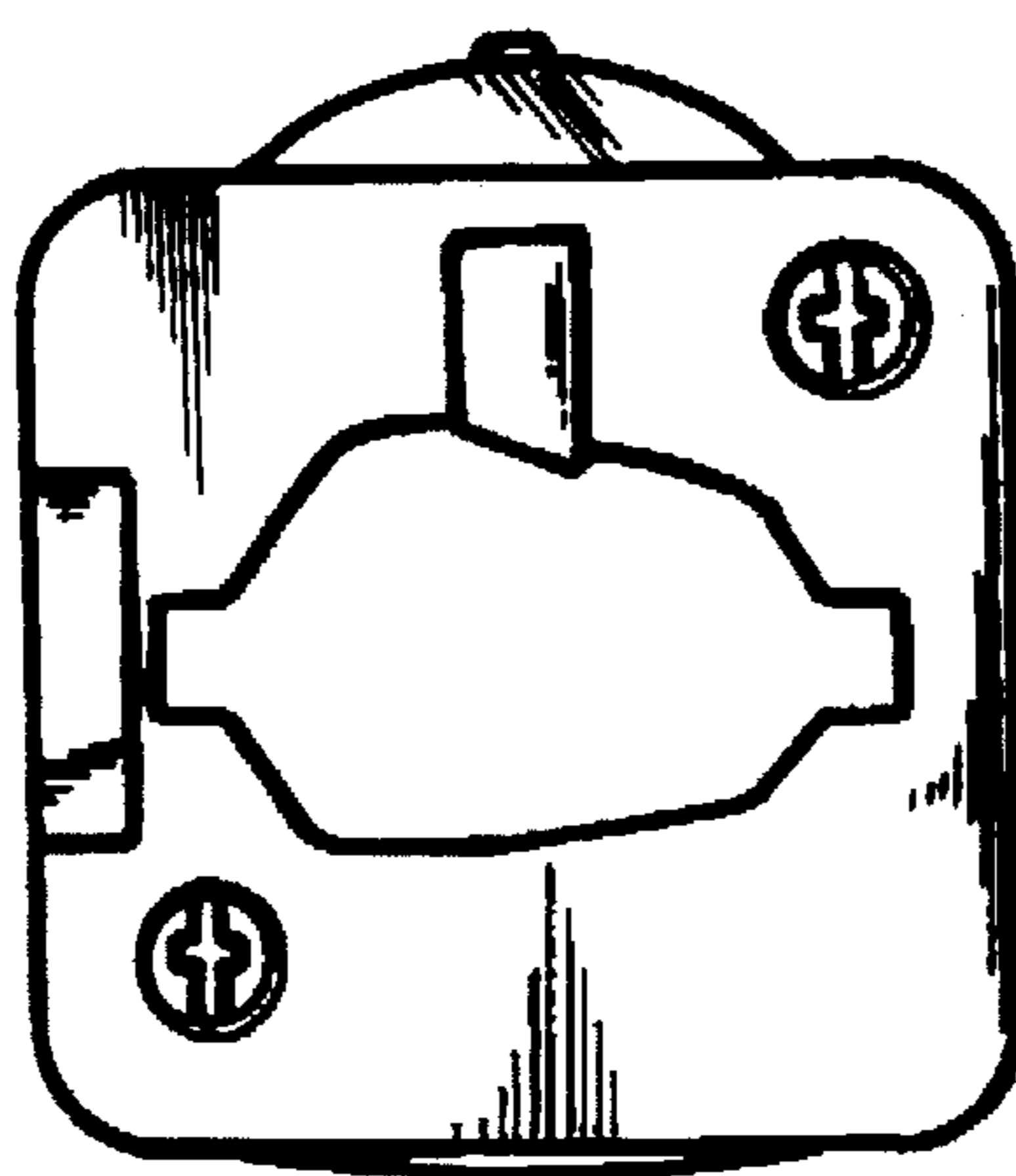

FIG. 7

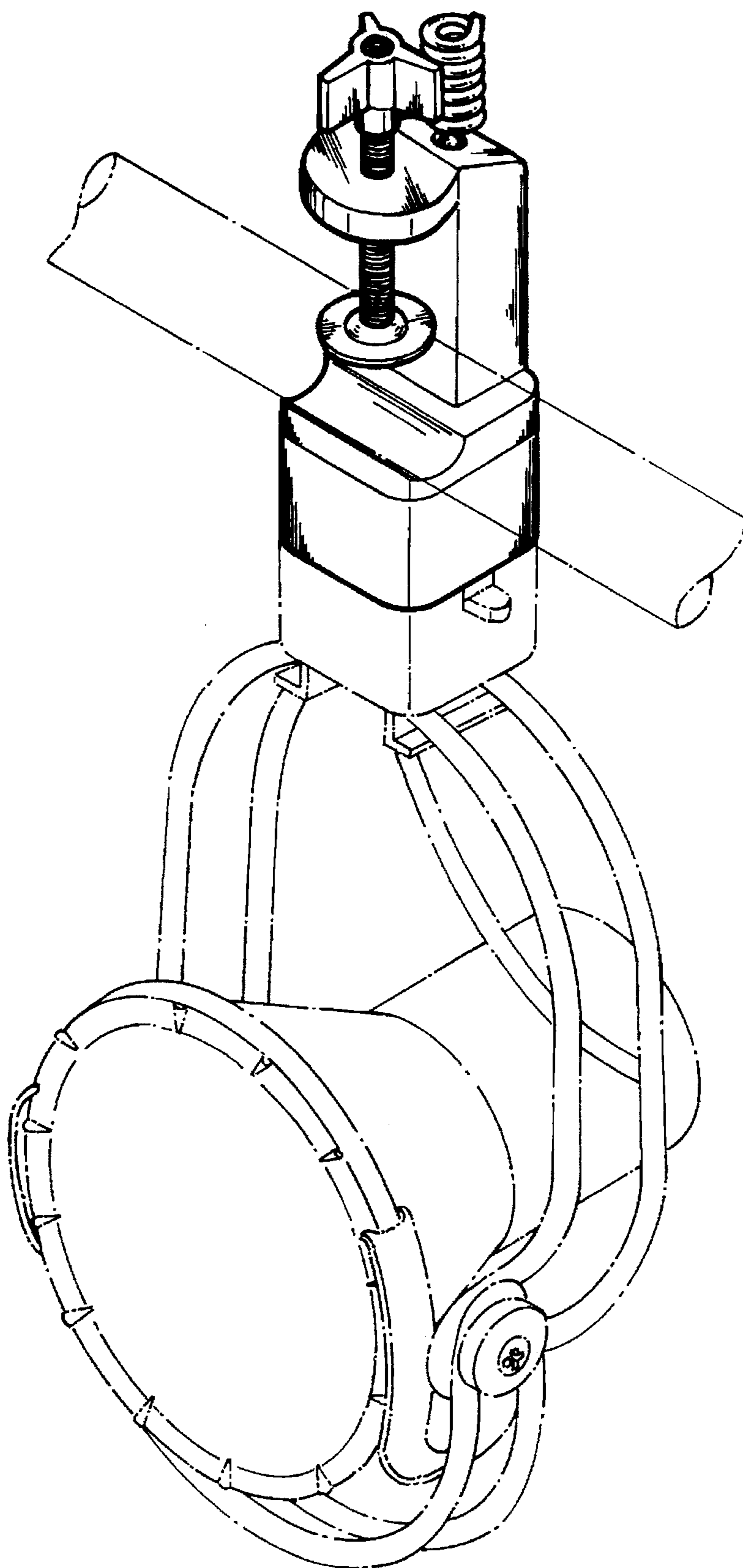

FIG. 8