



US00D383090S

United States Patent [19]

[11] Patent Number: **Des. 383,090**

Weder et al.

[45] Date of Patent: ****Sep. 2, 1997**

[54] FLOWER POT COVER

[75] Inventors: **Donald E. Weder; Joseph G. Straeter**, both of Highland, Ill.

[73] Assignee: **Southpac Trust International, Inc.**, Oklahoma City, Okla.; not individually, but as trustee of The Family Trust U/T/A dated December 8, 1995, Charles A. Coddling, Authorized Signatory for Southpac Trust International, Inc. trustee

[**] Term: **14 Years**

[21] Appl. No.: **54,130**

[22] Filed: **May 7, 1996**

Related U.S. Application Data

[60] Division of Ser. No. 4,961, Jan. 12, 1993, Pat. No. Des. 371,322, which is a continuation-in-part of Ser. No. 808,558, Dec. 16, 1991, Pat. No. Des. 362,408, which is a continuation-in-part of Ser. No. 710,272, Jun. 4, 1991, Pat. No. Des. 365,302, which is a continuation-in-part of Ser. No. 617,454, Nov. 21, 1990, abandoned, Ser. No. 411,249, Sep. 22, 1989, Pat. No. Des. 358,113, Ser. No. 411,247, Sep. 22, 1989, abandoned, and Ser. No. 411,245, Sep. 22, 1989, abandoned.

[51] LOC (6) Cl. **11-02**

[52] U.S. Cl. **D11/164**

[58] Field of Search D11/143, 149, D11/152-156, 164, 89, 90; 47/66, 72; 206/423; 215/100.5; 229/1.5 R, 1.5 B, 4.5, 108, 108.1, 109, 110, 87.01, 922, 930, 186, 189; 428/27, 35.1, 24, 542.6; 338/122; D9/346, 428-431; D27/102, 133; D26/128-136; D19/96; D7/540, 584, 586, 587, 354

[56] References Cited

U.S. PATENT DOCUMENTS

170,991	12/1875	Conover	229/186
D. 292,182	10/1987	Weder et al.	D11/164
D. 292,562	11/1987	Weder et al.	D11/164
D. 293,224	12/1987	Weder et al.	D11/164
D. 293,775	1/1988	Weder et al.	D11/164
D. 315,878	4/1991	Weder et al.	D11/164
D. 317,583	6/1991	Weder et al.	D11/164

D. 318,030	7/1991	Weder et al.	D11/164
D. 327,234	6/1992	Vaughn	D11/143
D. 358,113	5/1995	Weder et al.	D11/164
D. 361,957	9/1995	Weder et al.	D11/164
D. 362,408	9/1995	Weder et al.	D11/164
D. 364,119	11/1995	Weder et al.	D11/164
D. 371,322	7/1996	Weder et al.	D11/164
1,065,486	6/1913	Washburn	229/400
2,054,934	9/1936	Graffenberger	229/1.5 B
2,102,510	12/1937	Cecil, 2nd	229/1.5 B
2,355,559	8/1944	Renner	229/8
2,459,073	1/1949	Hamilton	229/1.5 B
3,423,007	1/1969	Christensson	229/186 X
5,016,813	5/1991	Simons	229/189
5,127,817	7/1992	Weder et al.	425/383
5,339,565	8/1994	Weder et al.	229/1.5 B

FOREIGN PATENT DOCUMENTS

103316	3/1938	Australia	229/922
--------	--------	-----------	-------	---------

OTHER PUBLICATIONS

Exhibit A—Speed Cover© Brochure—The Simple Solution . . . , ©1989.

Primary Examiner—Jeffrey Asch
Attorney, Agent, or Firm—Dunlap & Coddling, P.C.

[57] CLAIM

The ornamental design for a flower pot cover, as shown and described.

DESCRIPTION

FIG. 1 is a perspective view of our new flower pot cover design;
 FIG. 2 is an end elevational view thereof, the opposite end being a mirror image thereof;
 FIG. 3 is a top plan view thereof;
 FIG. 4 is a bottom plan view thereof;
 FIG. 5 is an end elevational view of the design of FIG. 1, the only difference being in the horizontal angle of the skirt;
 FIG. 6 is an end elevational view of the design of FIG. 1, the only difference being in the near vertical angle of the skirt;
 FIG. 7 is an end elevational view of the design of FIG. 1, the only difference being in the downward angle of the skirt;
 FIG. 8 is a perspective view of a second embodiment of our new flower pot cover design, the only difference over FIG. 1 being that the sides are straight up and down;

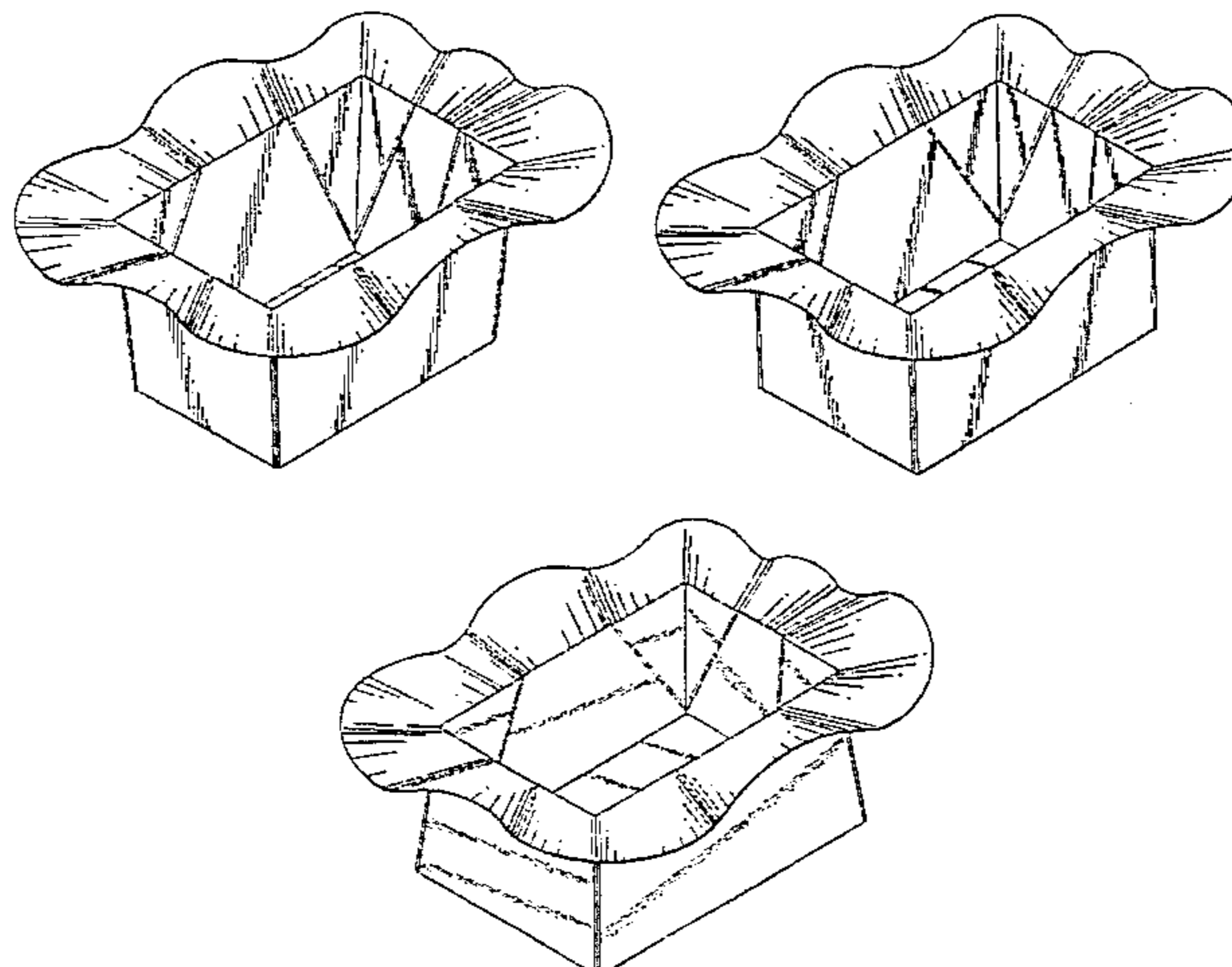

FIG. 9 is an end elevational view thereof, the opposite end being a mirror image thereof;

FIG. 10 is a top plan view thereof;

FIG. 11 is a bottom plan view thereof;

FIG. 12 is an end elevational view of the design of FIG. 8, the only difference being in the horizontal angle of the skirt;

FIG. 13 is an end elevational view of the design of FIG. 8, the only difference being in the near vertical angle of the skirt;

FIG. 14 is an end elevational view of the design of FIG. 8, the only difference being in the downward angle of the skirt;

FIG. 15 is a perspective view of a third embodiment of our new flower pot cover design, the only difference over FIG. 1 being that the sides are tapered out toward the bottom;

FIG. 16 is an end elevational view thereof, the opposite end being a mirror image thereof;

FIG. 17 is a top plan view thereof;

FIG. 18 is a bottom plan view thereof;

FIG. 19 is an end elevational view of the design of FIG. 15, the only difference being in the horizontal angle of the skirt;

FIG. 20 is an end elevational view of the design of FIG. 15, the only difference being in the near vertical angle of the skirt; and,

FIG. 21 is an end elevational view of the design of FIG. 15, the only difference being in the downward angle of the skirt.

The flower pot cover has no substantial thickness.

1 Claim, 4 Drawing Sheets

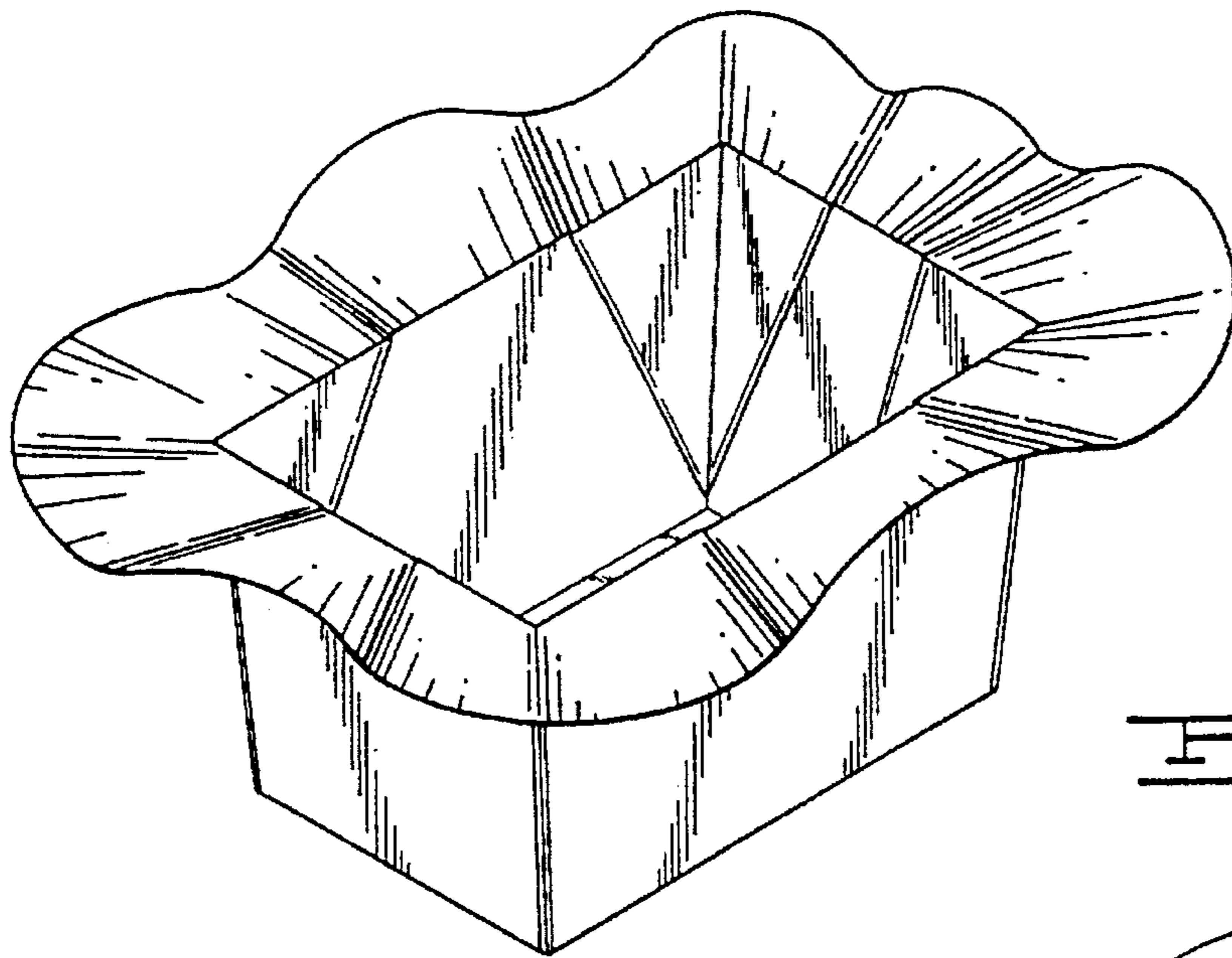

FIG. 1

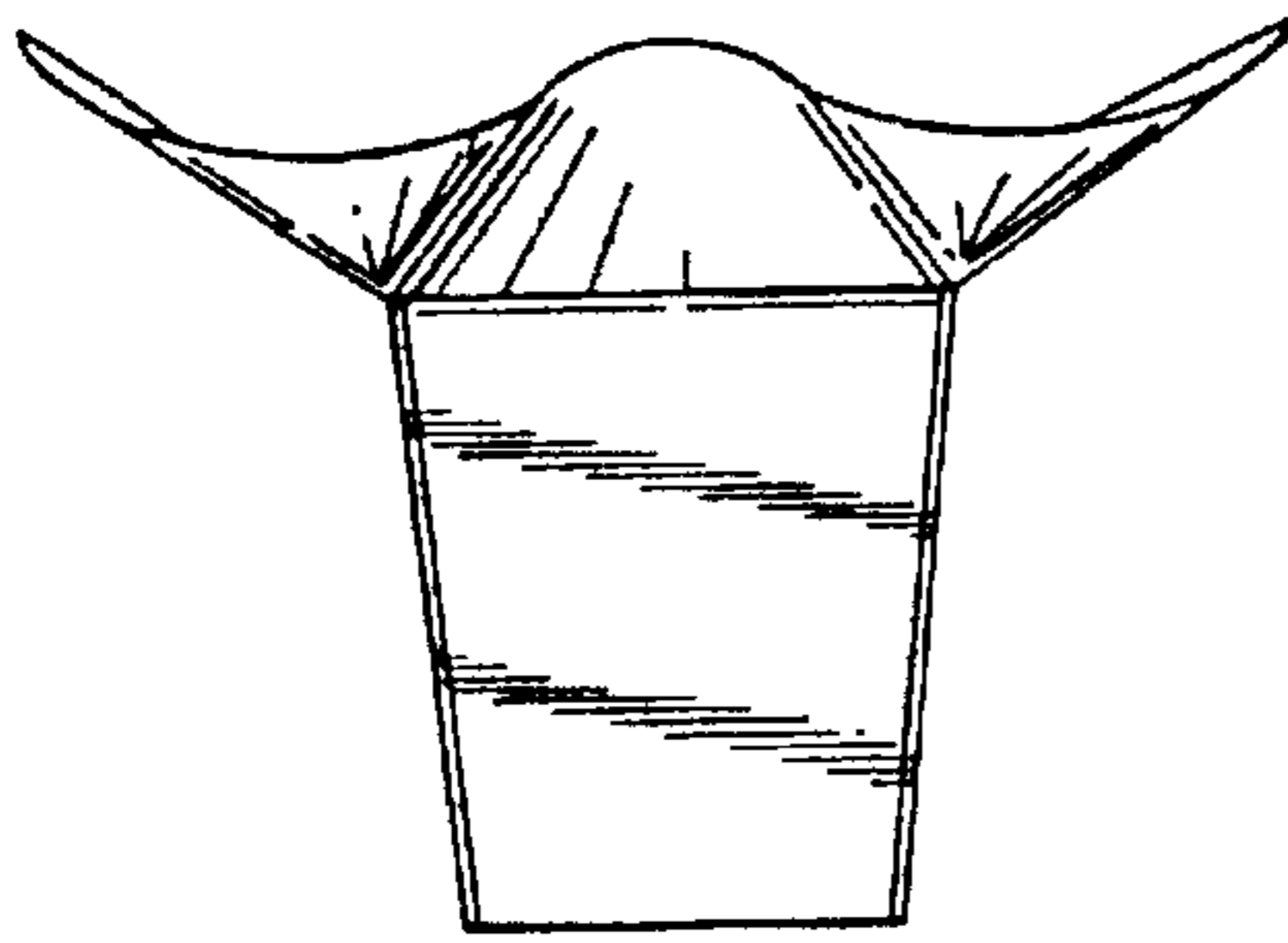

FIG. 2

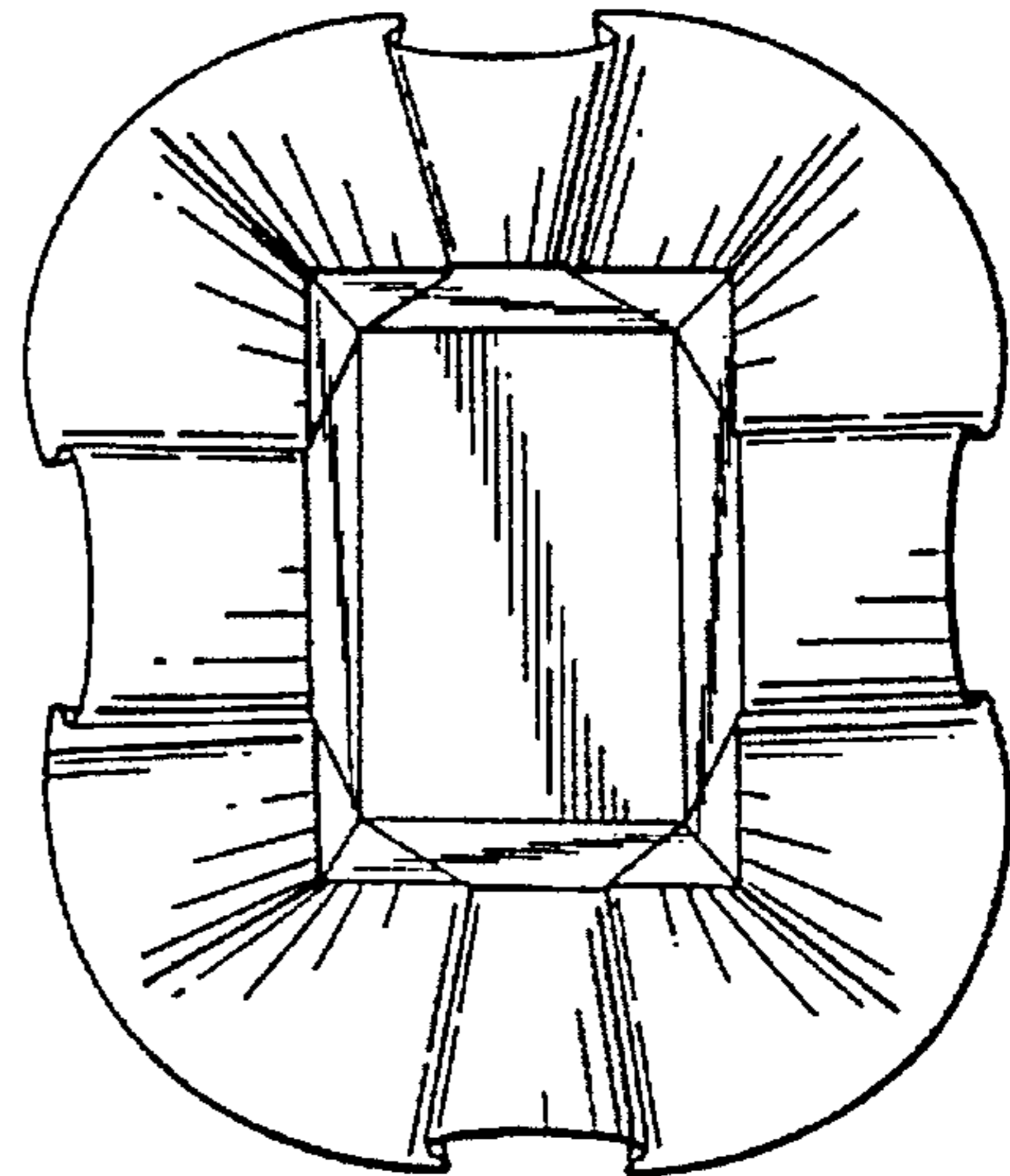

FIG. 3

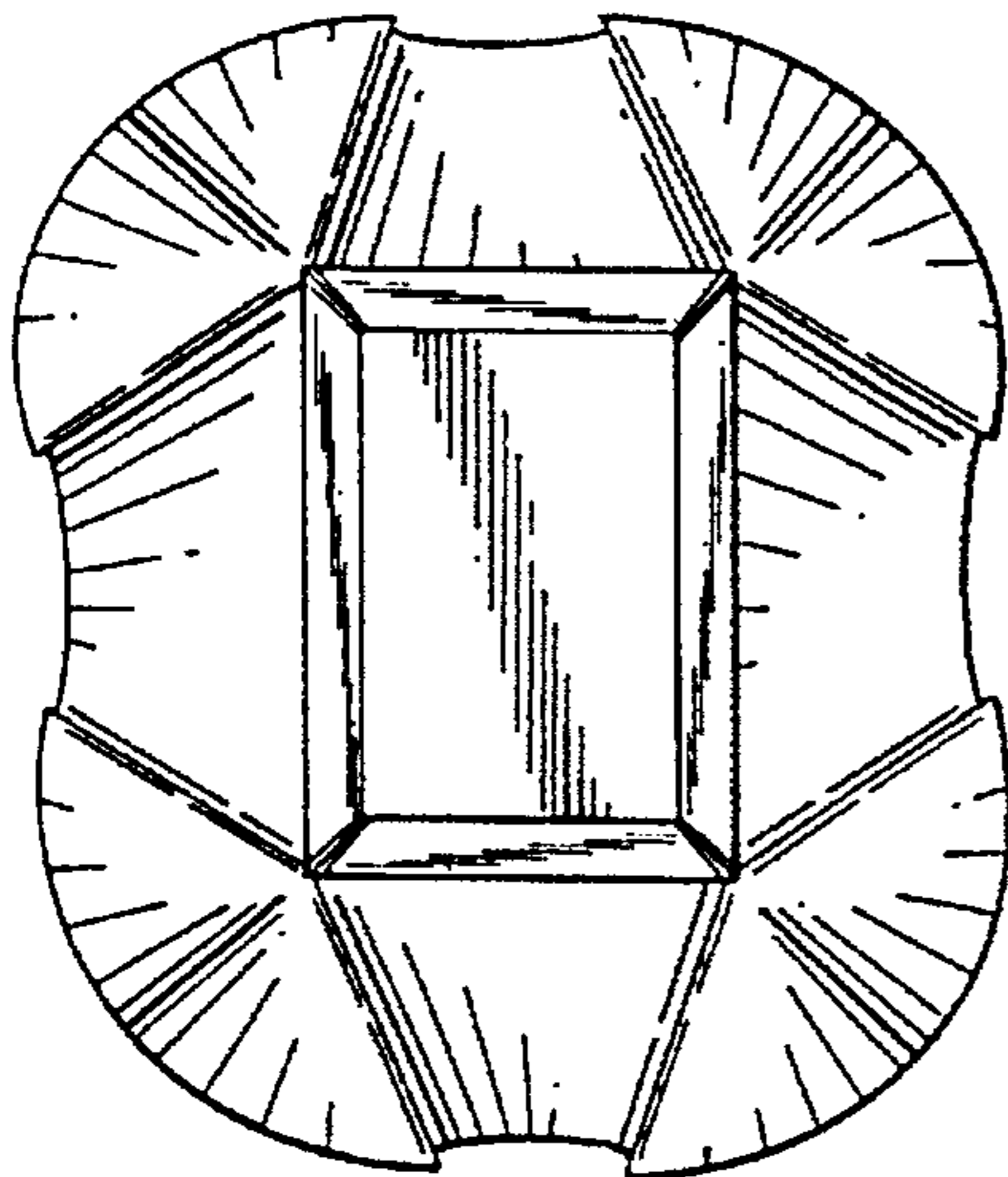

FIG. 4

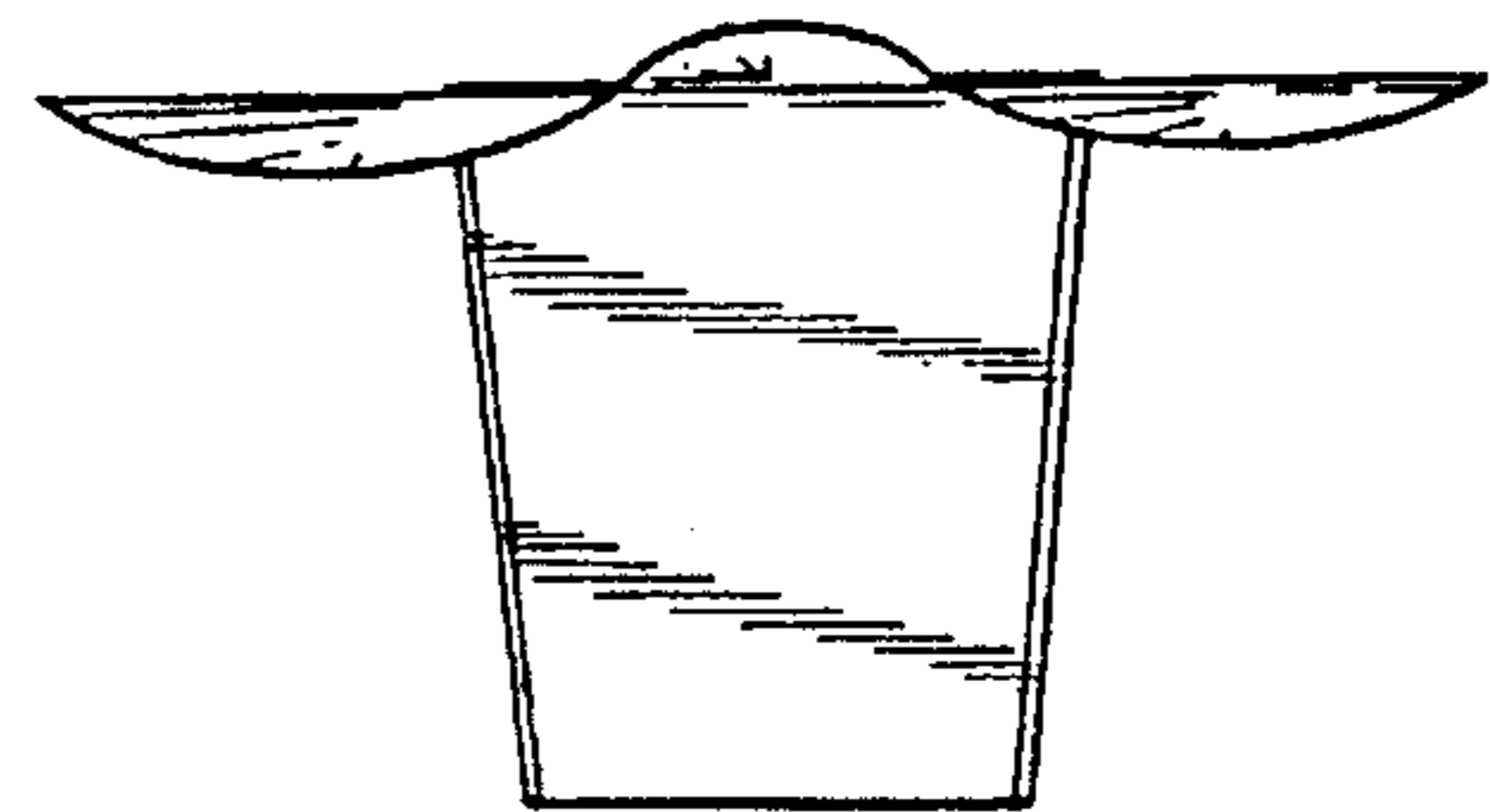
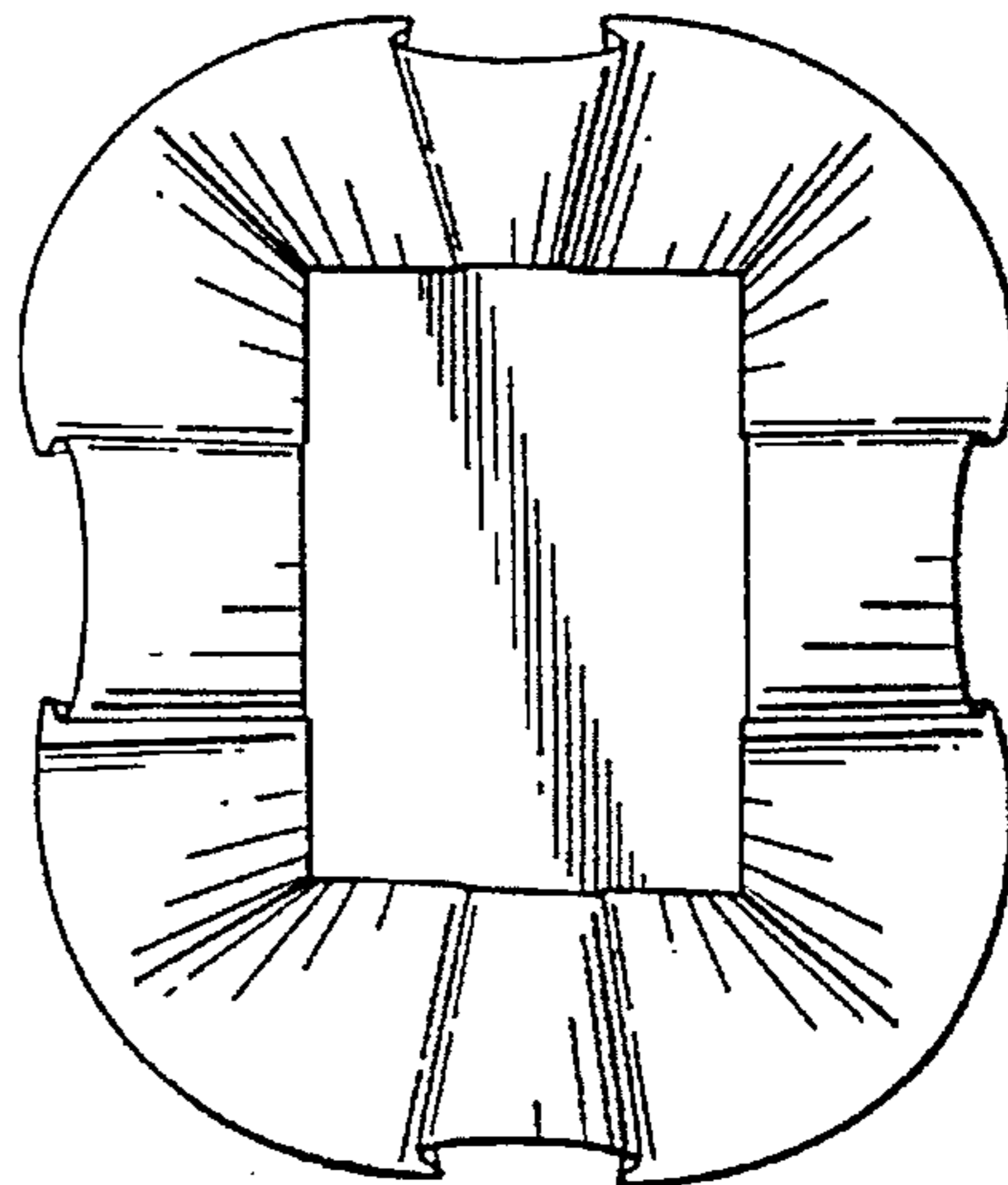
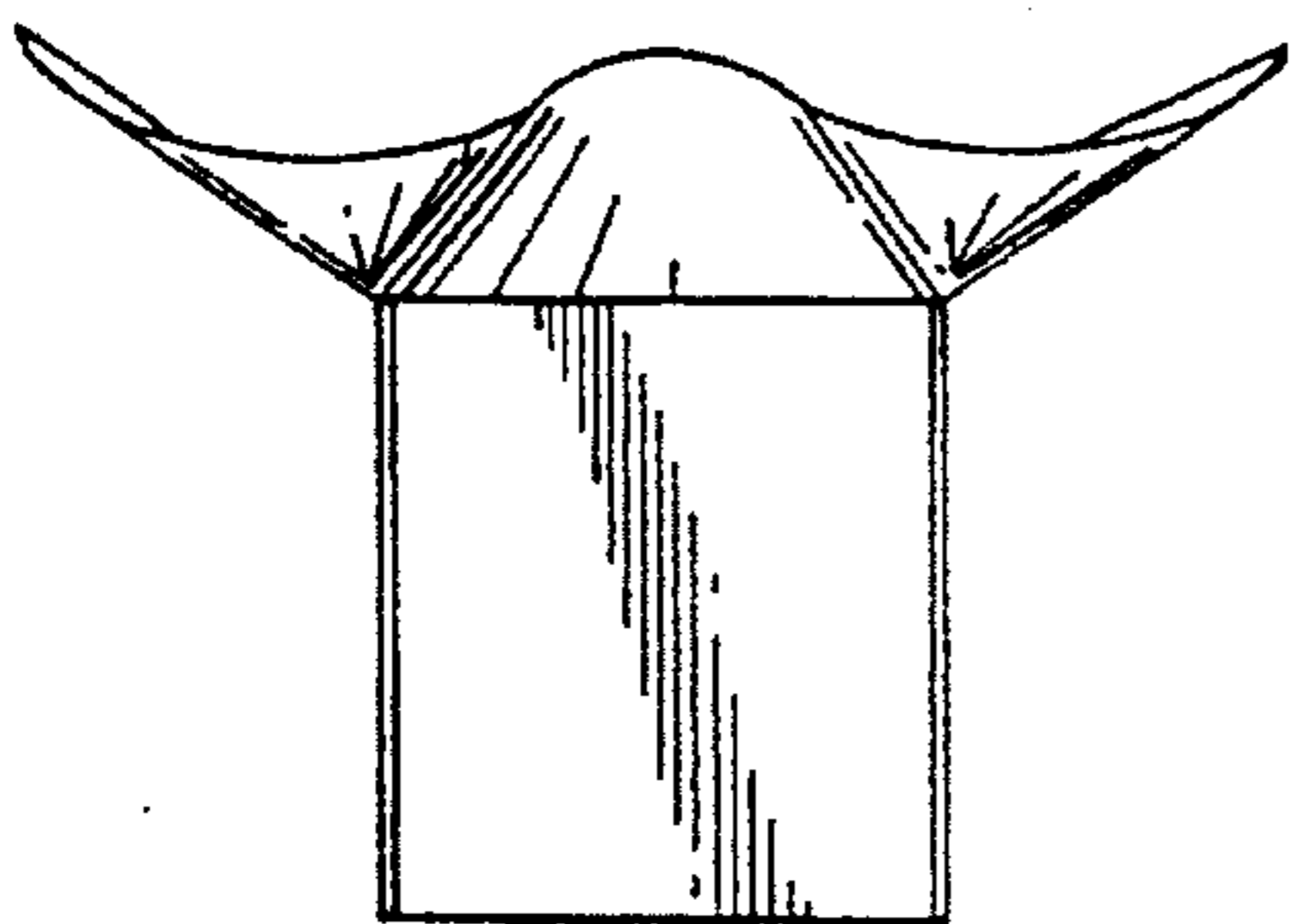
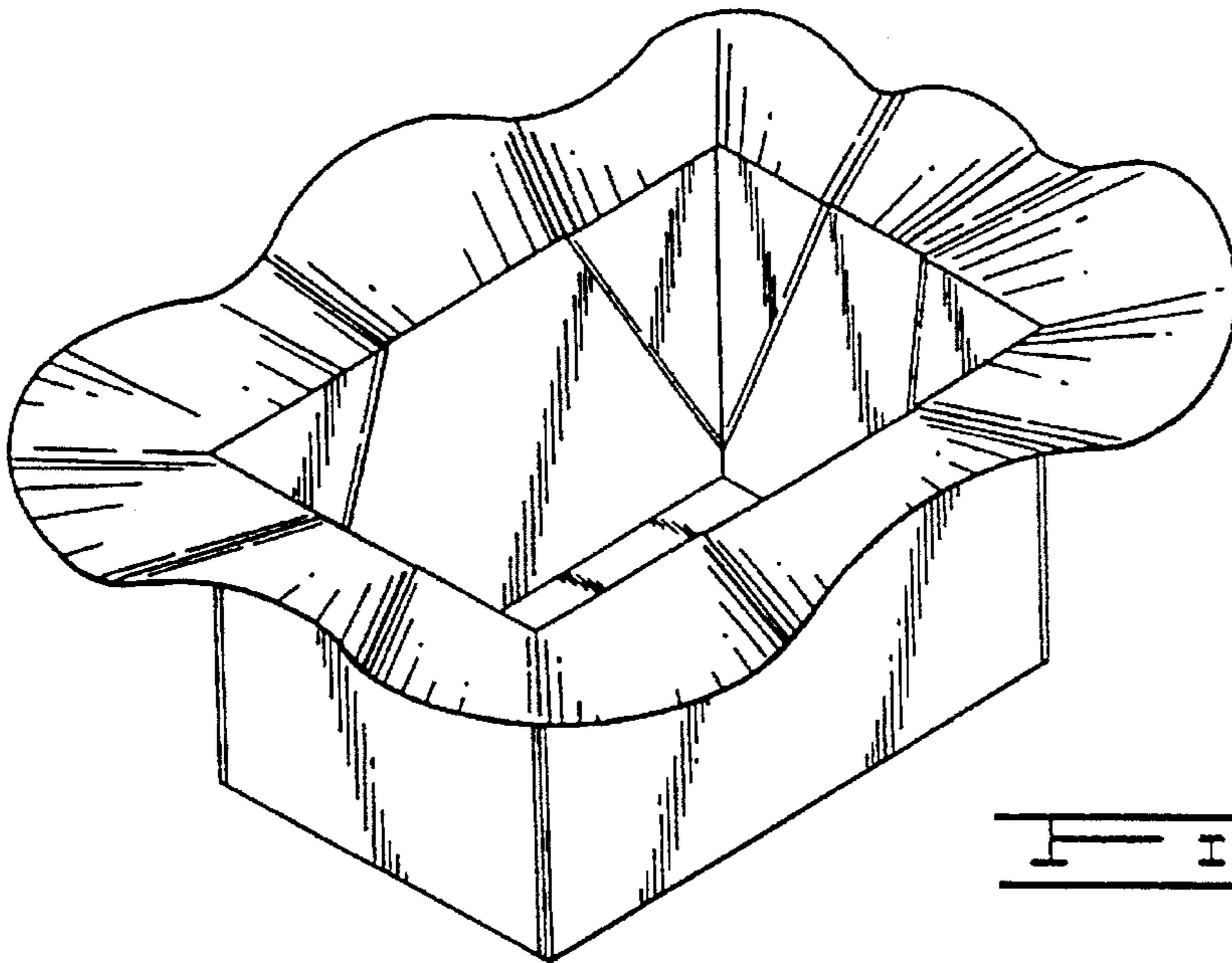
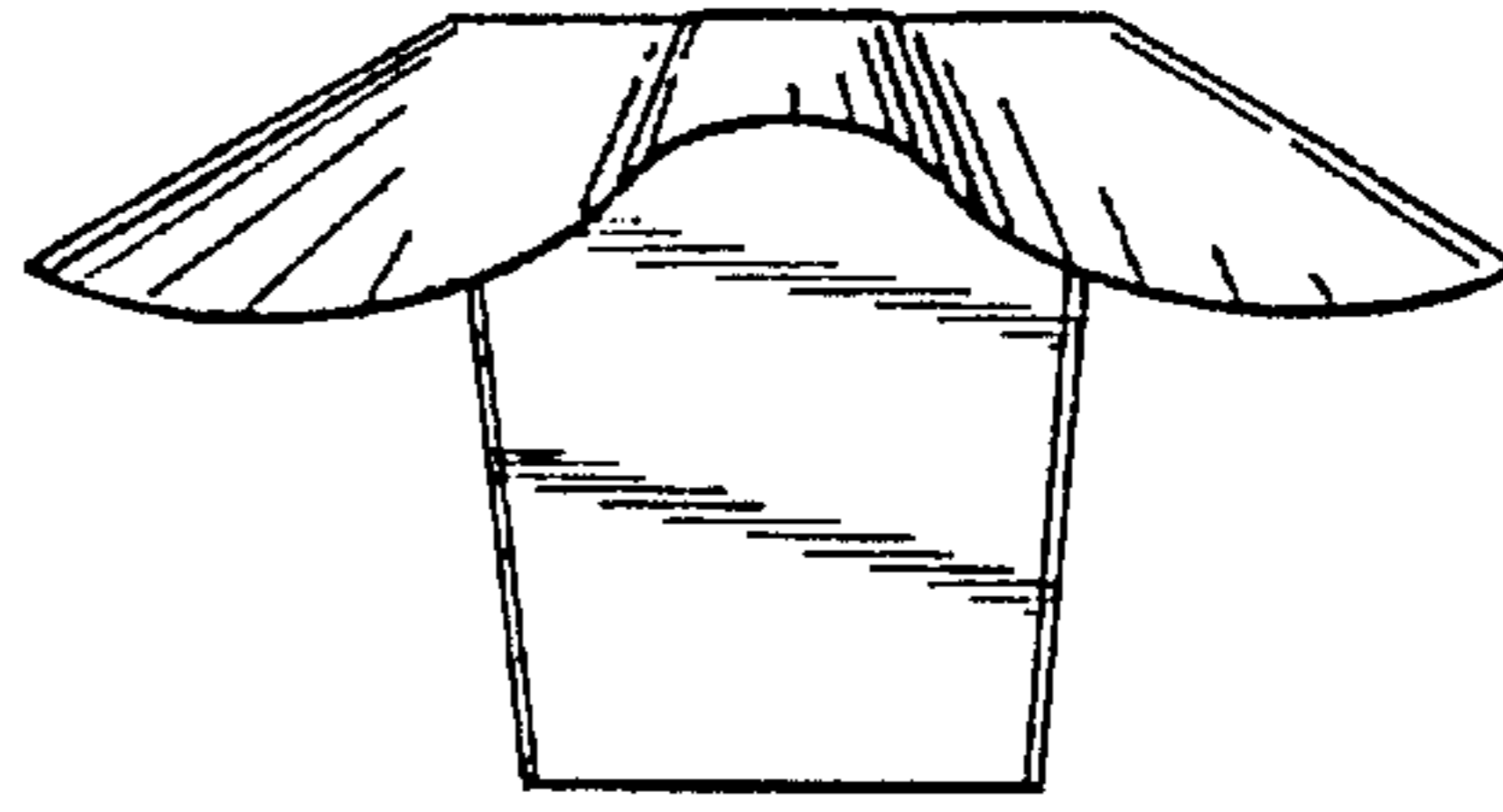
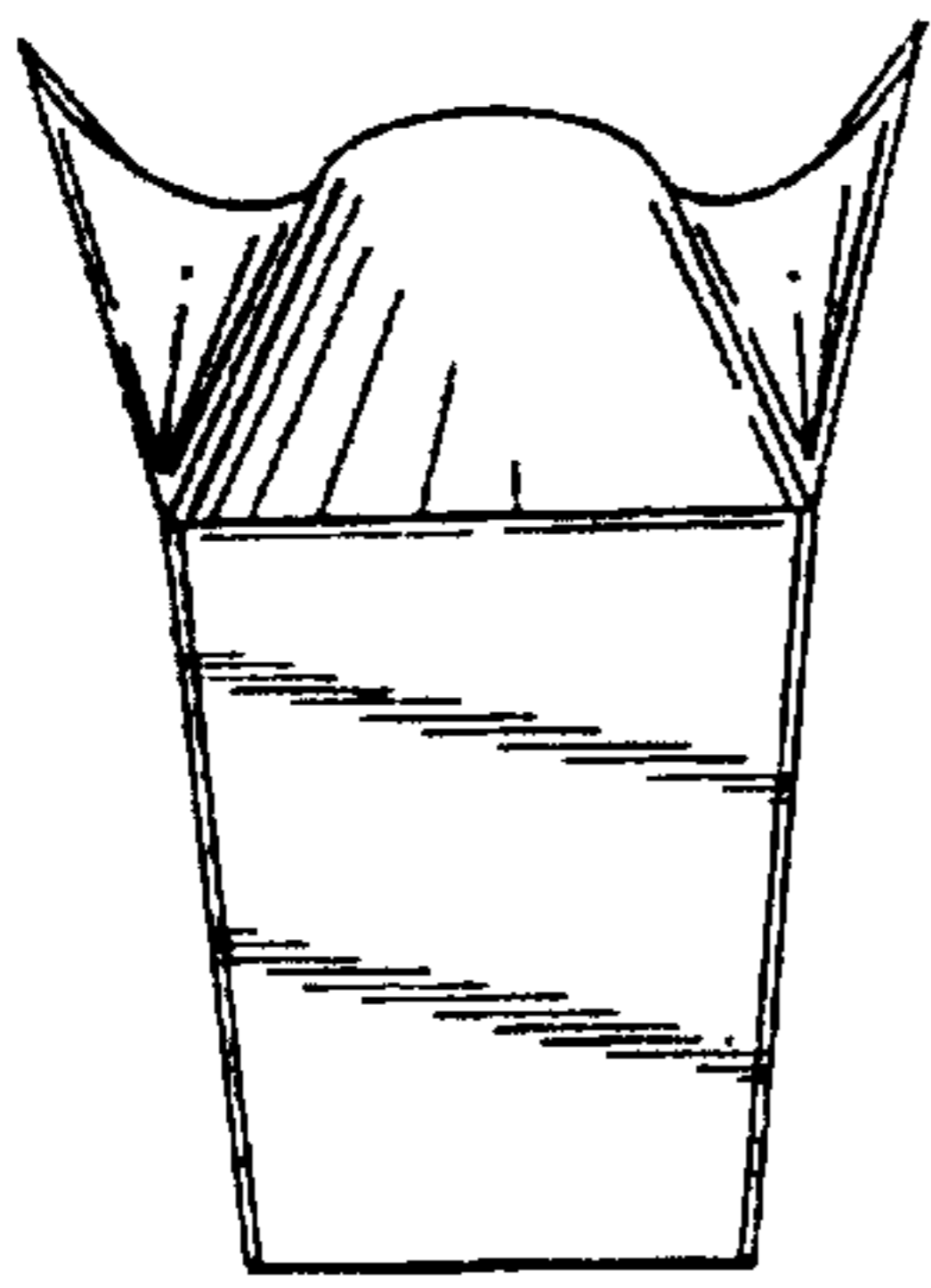

FIG. 5



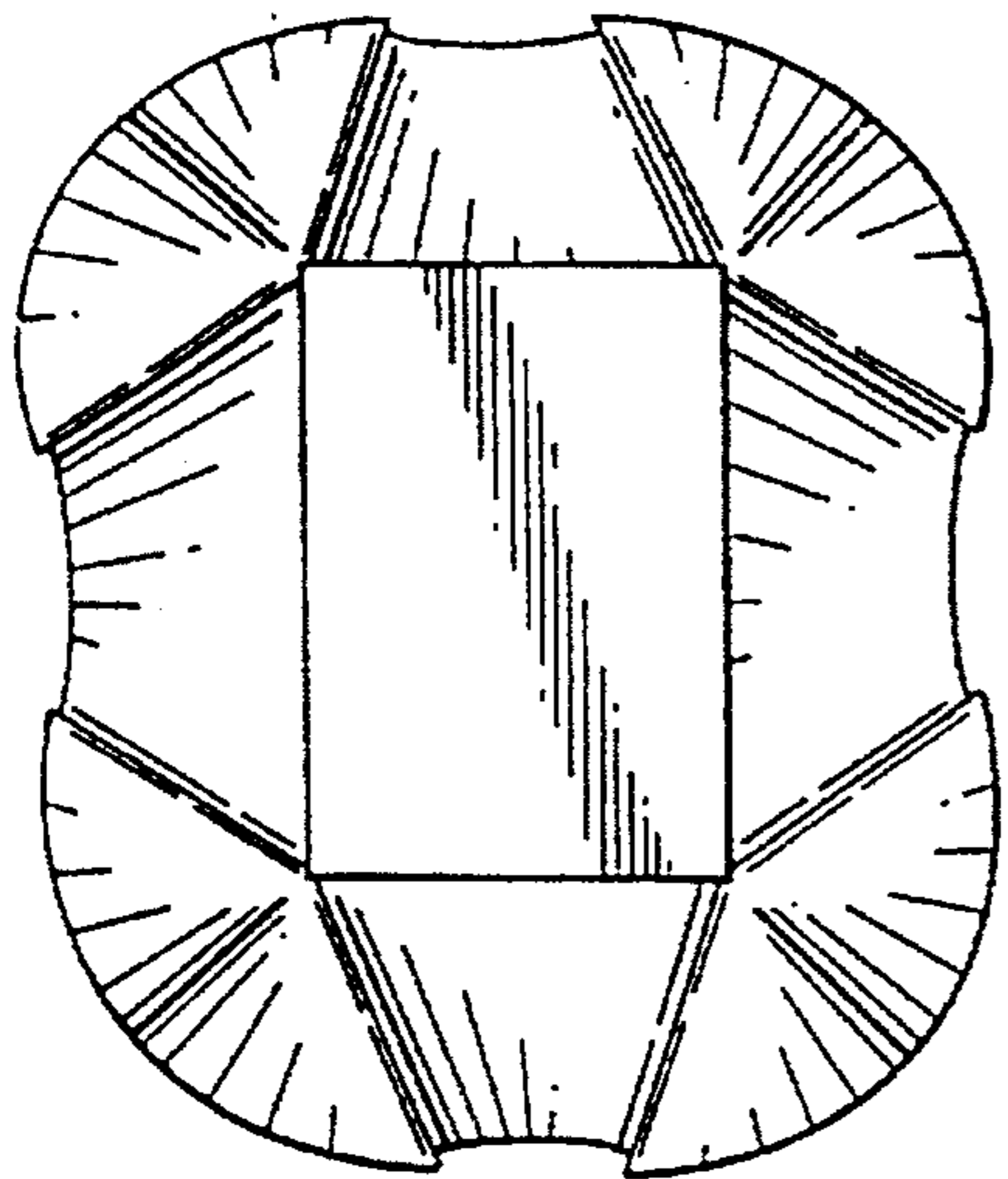

FIG. 11

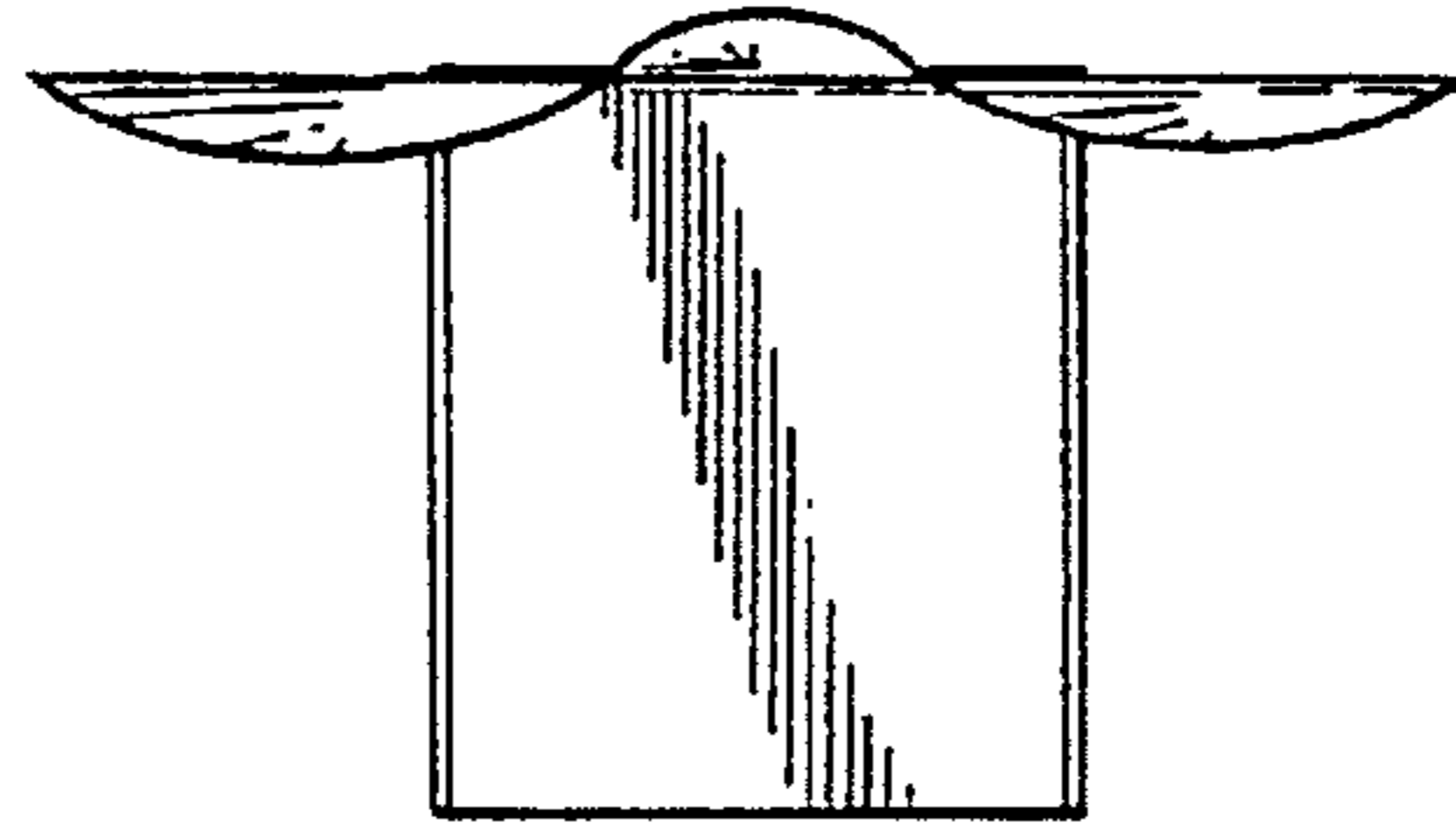

FIG. 12

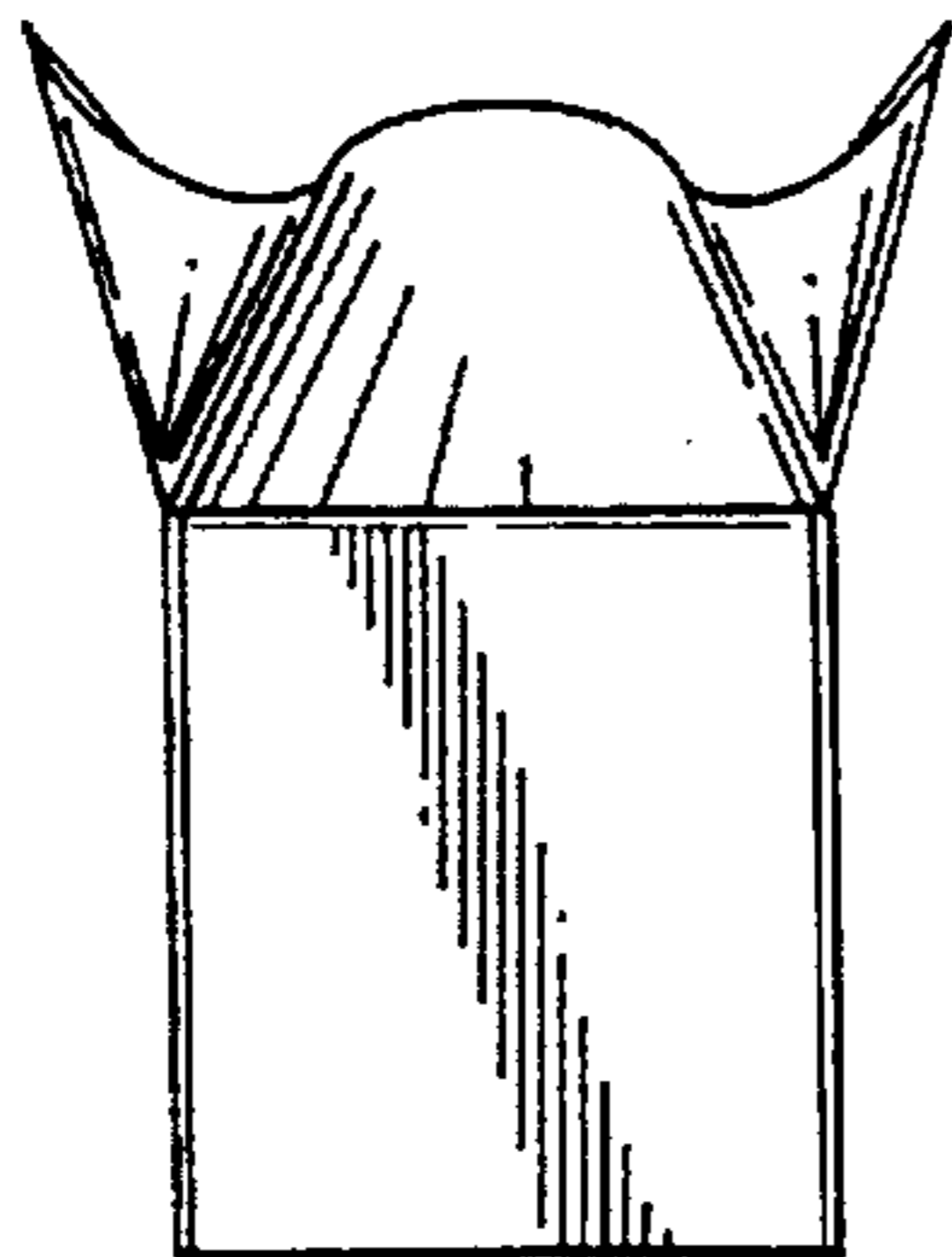

FIG. 13

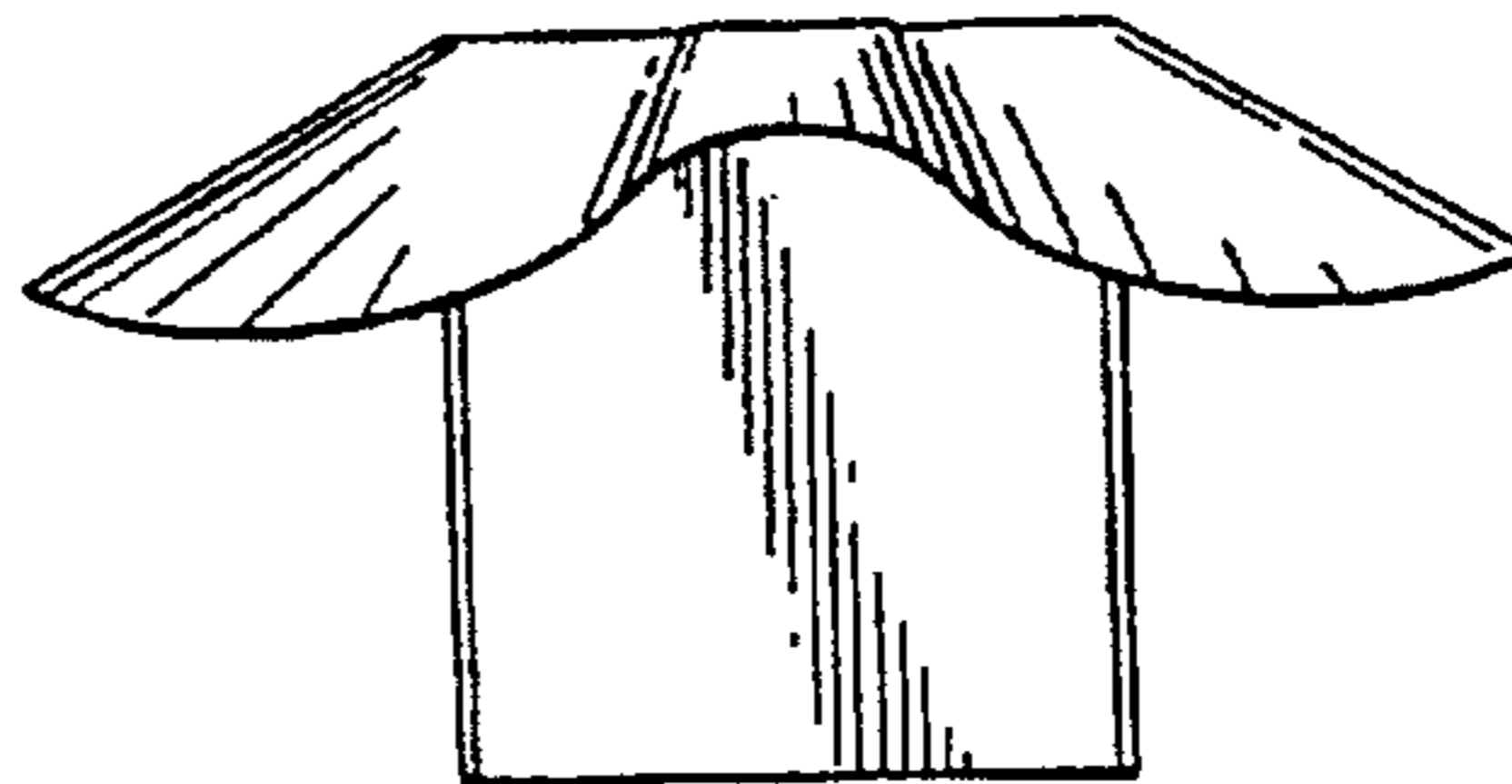

FIG. 14

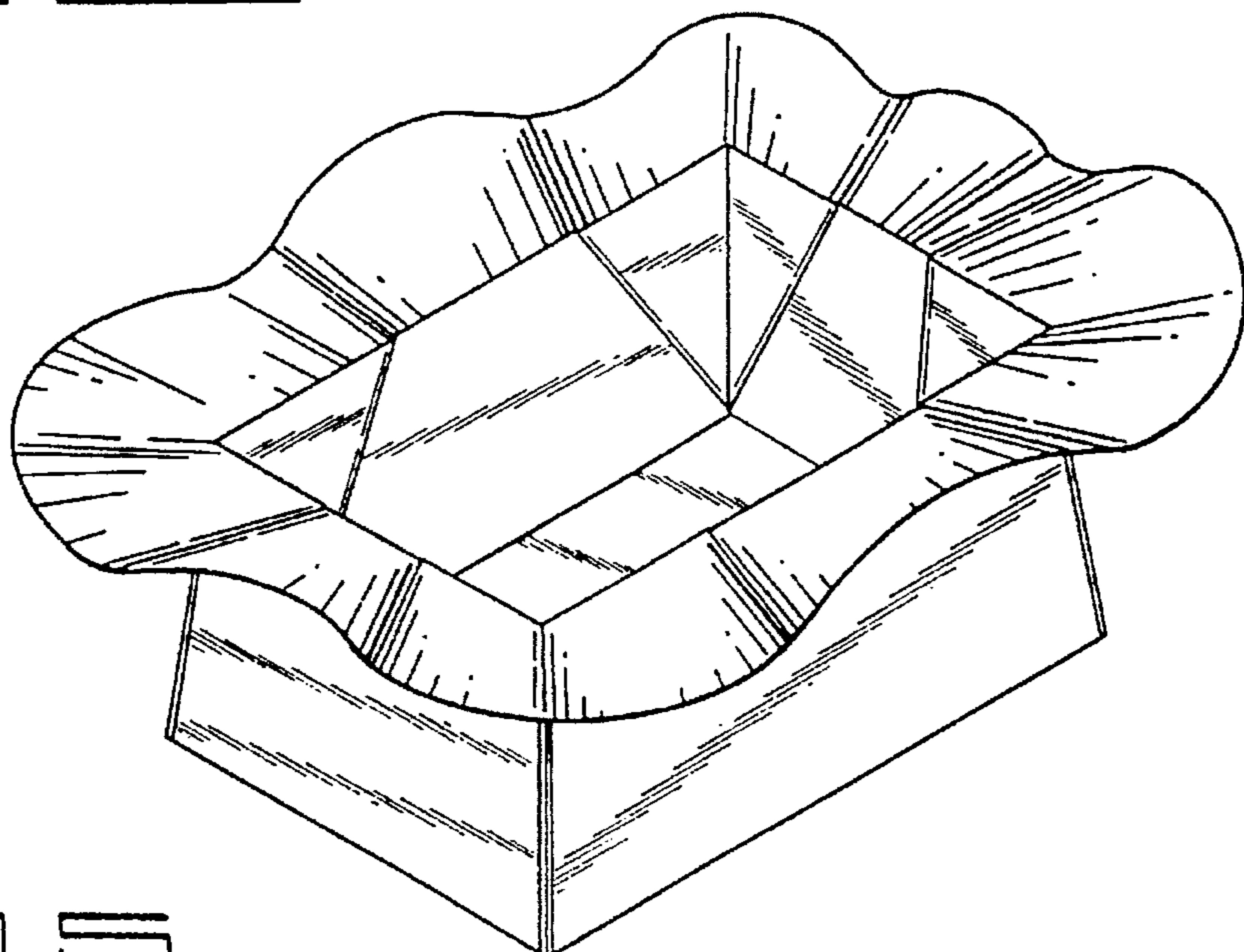

FIG. 15

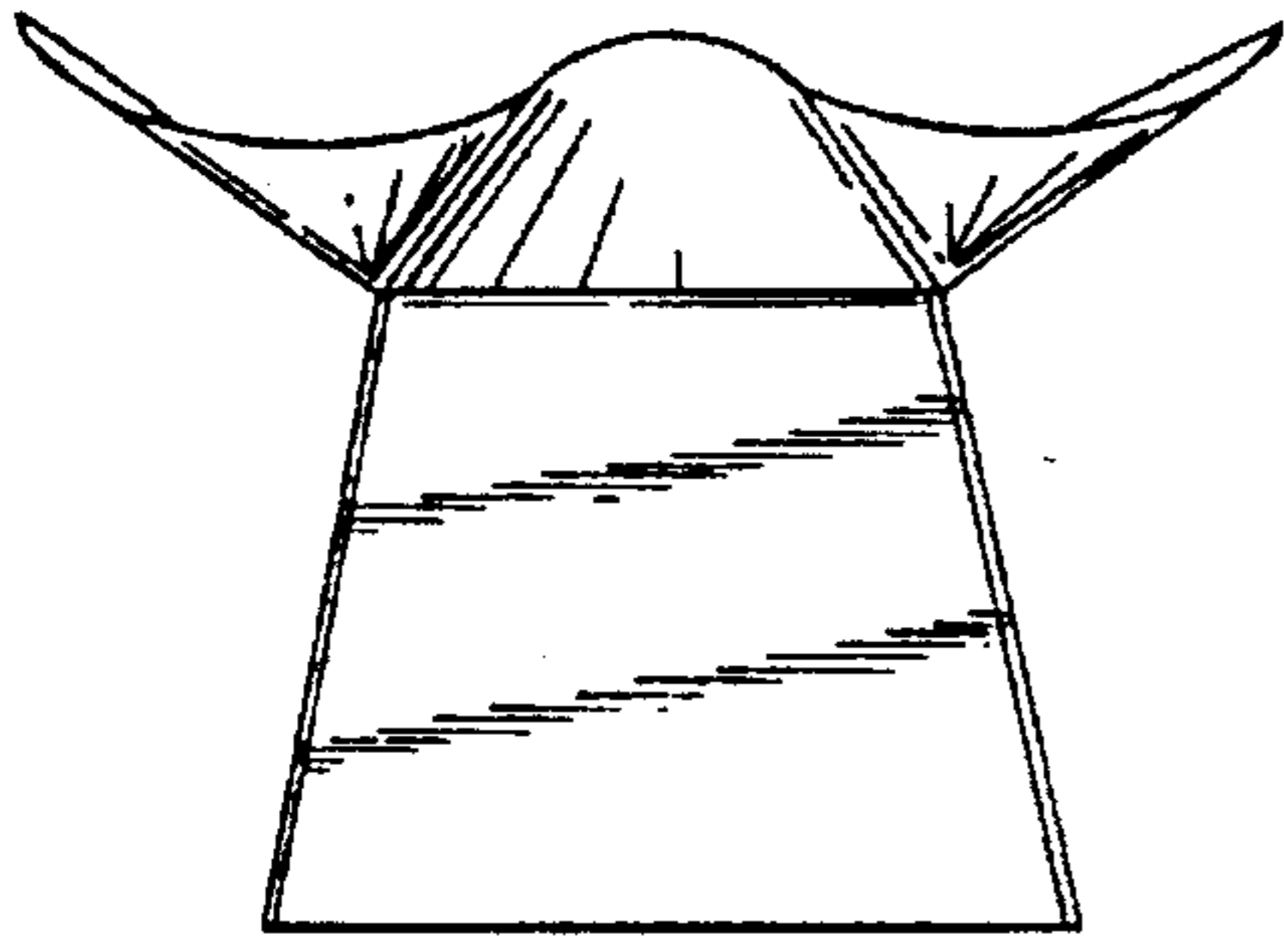

FIG. 16

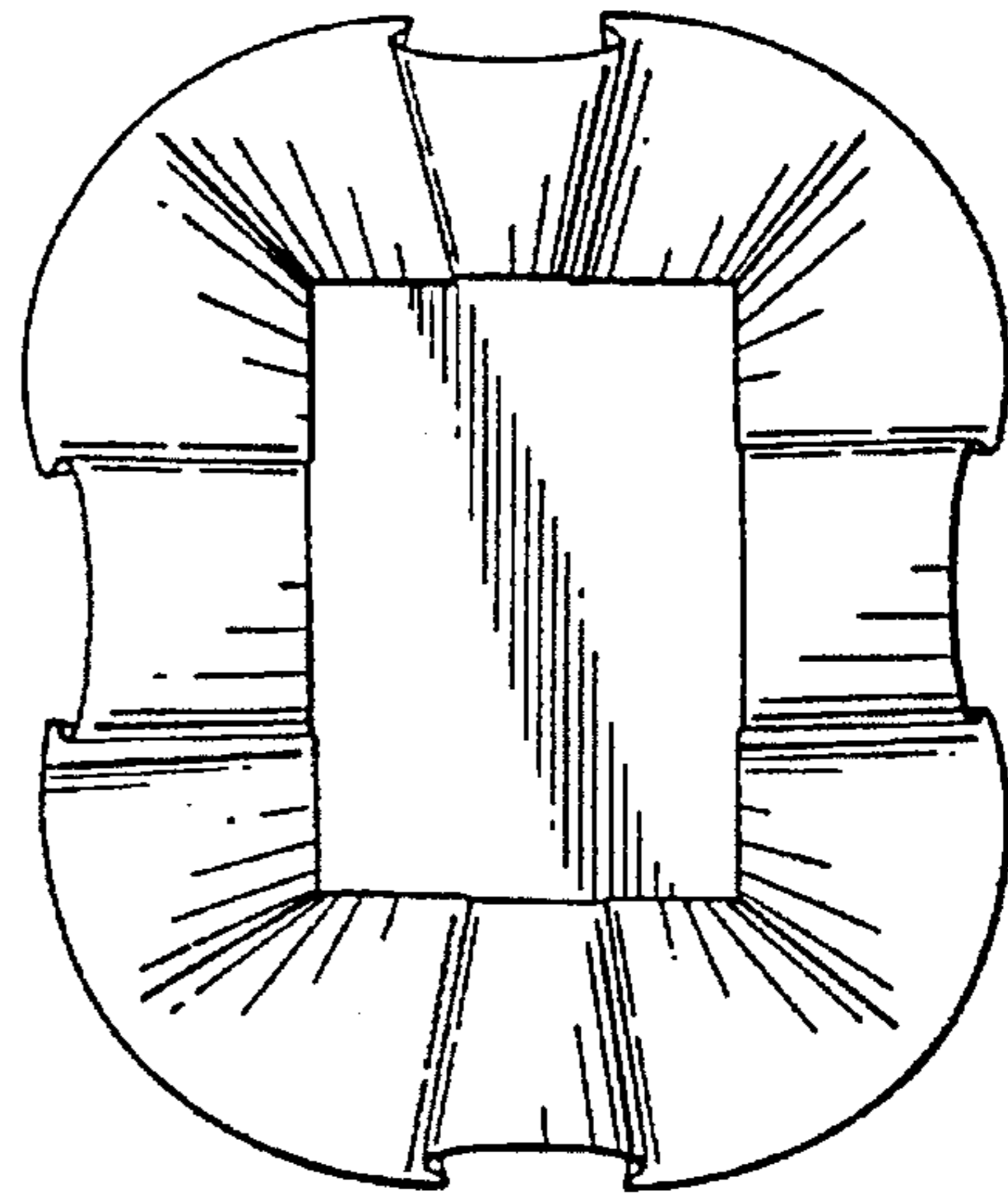

FIG. 17

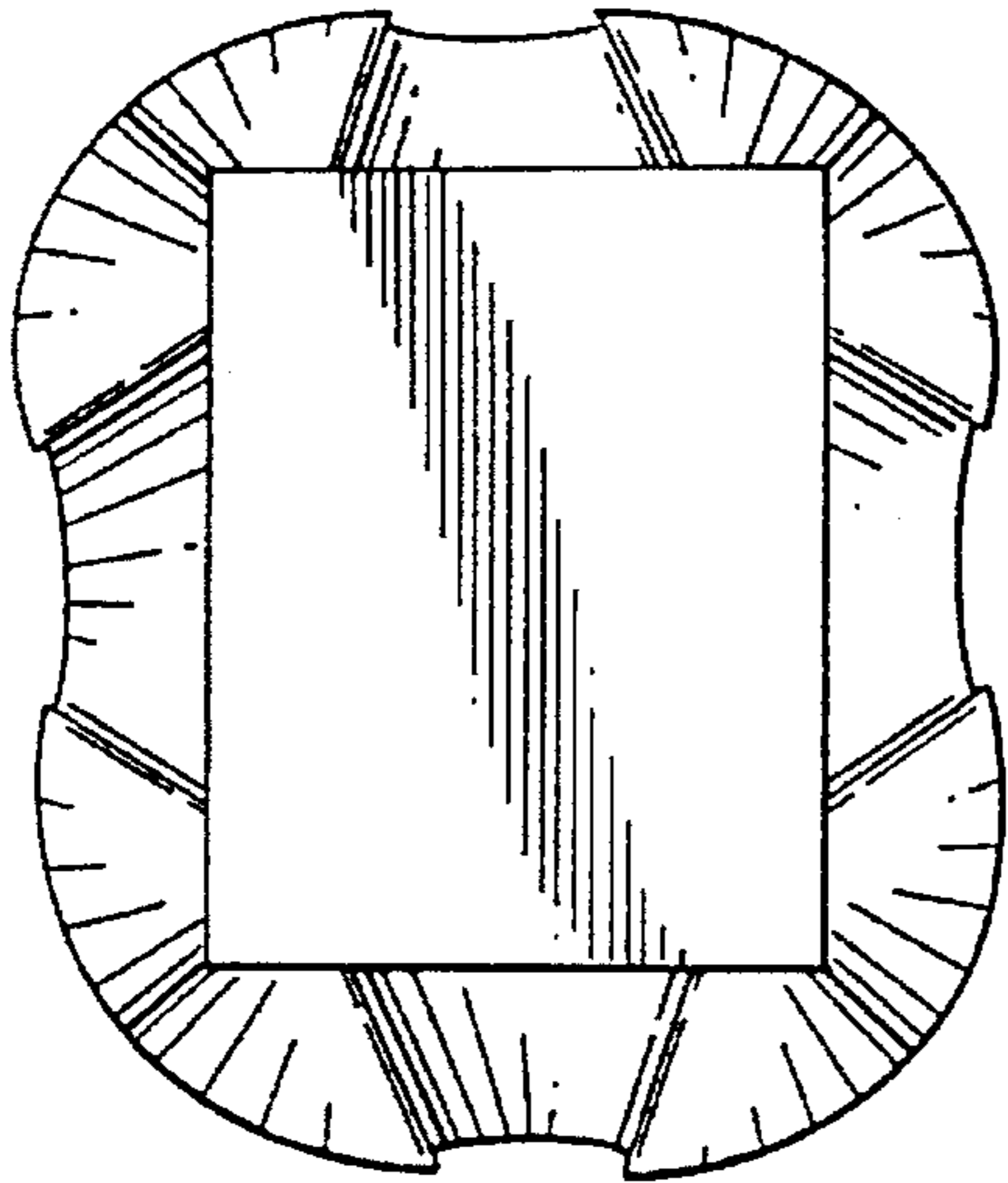

FIG. 18

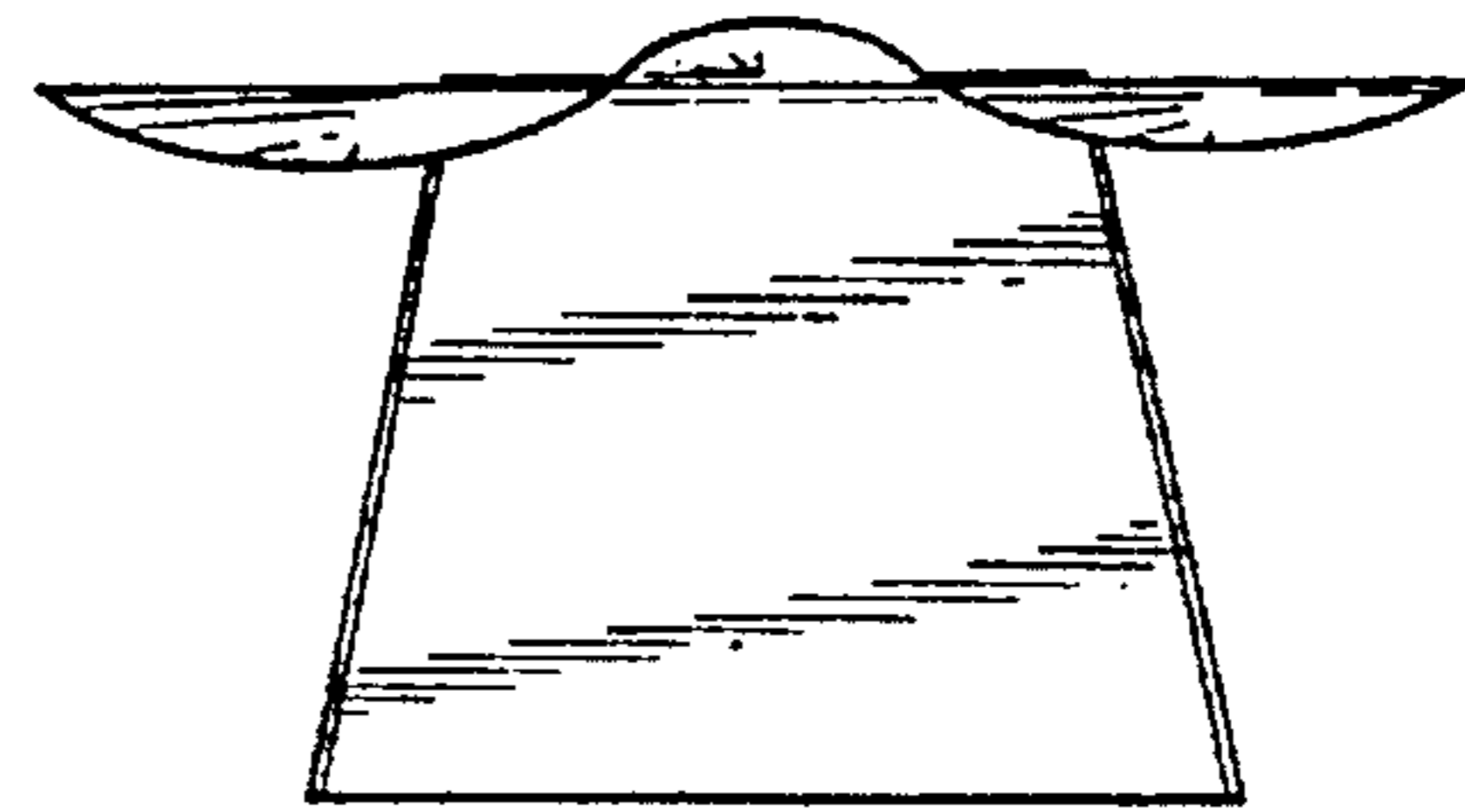

FIG. 19

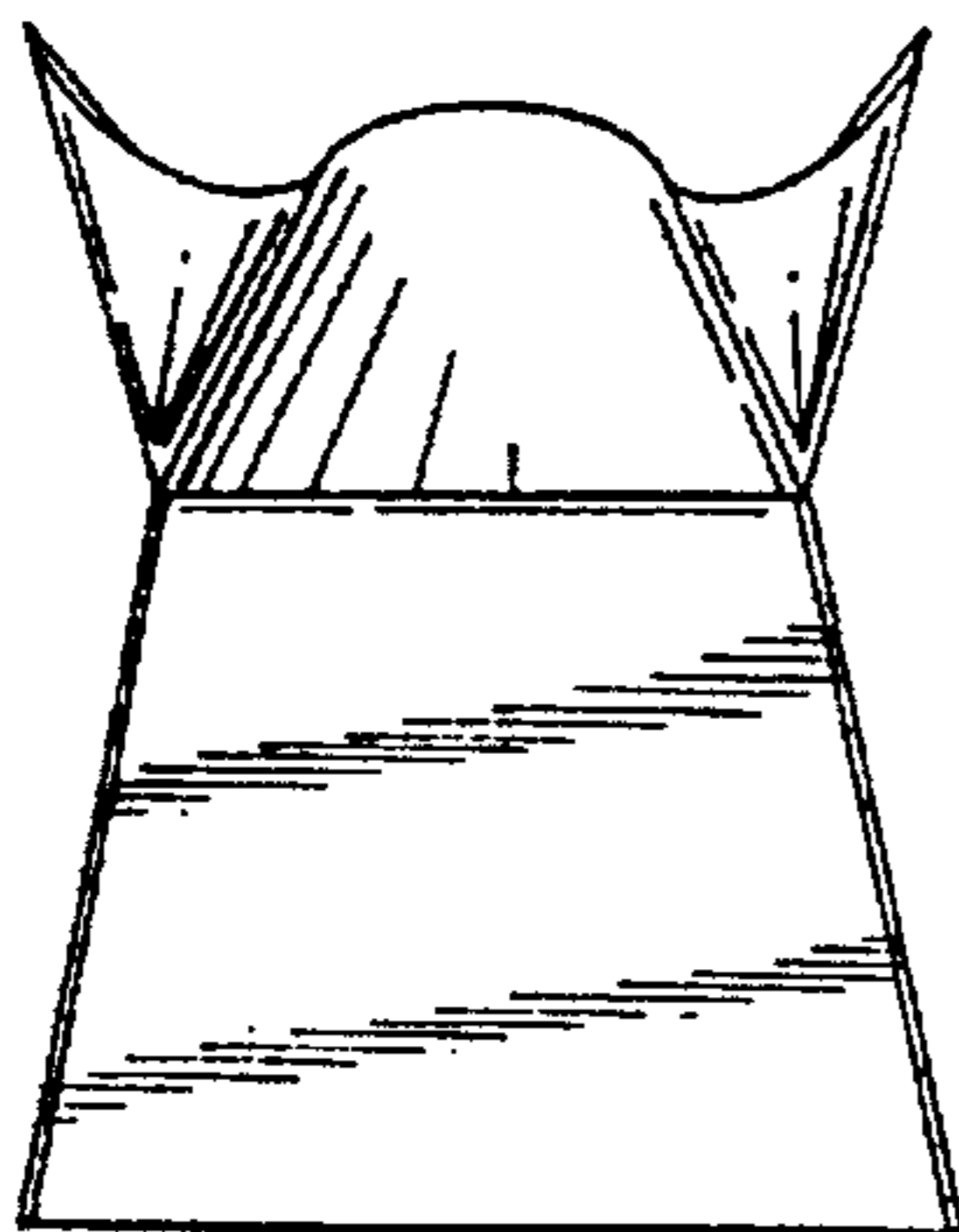

FIG. 20

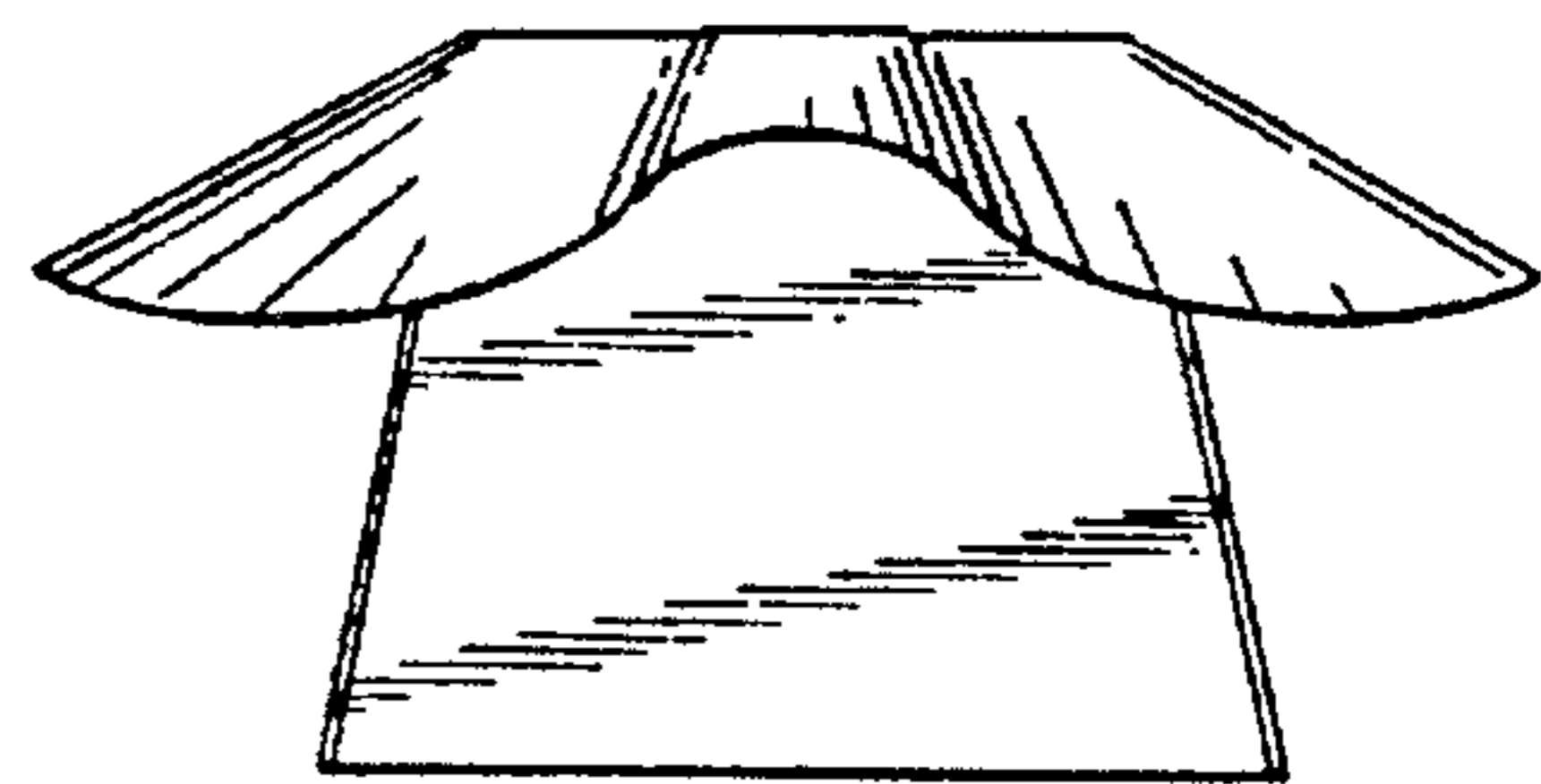

FIG. 21