



US00D383086S

# United States Patent [19]

[11] Patent Number: **Des. 383,086**

Weder et al.

[45] Date of Patent: **\*\*Sep. 2, 1997**

## [54] FLOWER POT COVER

[75] Inventors: **Donald E. Weder; Joseph G. Straeter**, both of Highland, Ill.

[73] Assignee: **Southpac Trust International, Inc.**, Oklahoma City, Okla.; not individually, but as trustee of the Family Trust U/T/A dated December 8, 1995, Charles A. Codding, Authorized Signatory for Southpac Trust International, Inc., trustee

[\*] Notice: The portion of the term of this patent subsequent to Oct. 24, 2009, has been disclaimed.

[\*\*] Term: **14 Years**

[21] Appl. No.: **3,287**

[22] Filed: **Jan. 5, 1993**

### Related U.S. Application Data

[63] Continuation-in-part of Ser. No. 809,637, Dec. 16, 1991, Pat. No. Des. 363,451, which is a continuation-in-part of Ser. No. 710,272, Jun. 4, 1991, Pat. No. Des. 365,302, which is a continuation-in-part of Ser. No. 617,454, Nov. 21, 1990, abandoned, Ser. No. 411,249, Sep. 22, 1989, Pat. No. Des. 358,113, Ser. No. 411,247, Sep. 22, 1989, abandoned, and Ser. No. 411,245, Sep. 22, 1989, abandoned.

[51] LOC (6) Cl. .... **11-02**

[52] U.S. Cl. .... **D11/164**

[58] Field of Search ..... D11/143, 149, D11/152-156, 164, 89, 90; 47/66, 72; 206/423; 215/100.5; 229/1.5 R, 1.5 B, 4.5, 87.01, 922, 930, 108, 108.1, 109, 110; 428/27, 35.1, 24, 542.6; D9/346, 428-431; D27/102, 133; D26/128-136; D19/96; D7/540, 584, 586, 587, 354

### [56] References Cited

#### U.S. PATENT DOCUMENTS

- D. 292,182 10/1987 Weder et al. .... D11/164
- D. 292,562 11/1987 Weder et al. .... D11/164
- D. 293,224 12/1987 Weder et al. .... D11/164

- D. 293,775 1/1988 Weder et al. .... D11/164
- D. 313,573 1/1991 Weder et al. .... D11/164
- D. 317,583 6/1991 Weder et al. .... D11/164
- D. 318,030 7/1991 Weder et al. .... D11/164
- D. 327,234 6/1992 Vaughn ..... D11/143
- D. 363,451 10/1995 Weder et al. .... D11/164
- D. 371,318 7/1996 Weder et al. .... D11/164
- D. 371,319 7/1996 Weder et al. .... D11/164
- 1,065,486 6/1913 Washburn ..... 229/400
- 2,054,934 9/1936 Graffenberger ..... 229/1.5 B
- 2,102,510 12/1937 Cecil, 2d ..... 229/1.5 B
- 2,355,559 8/1944 Renner ..... 229/8
- 2,367,749 1/1945 Barbieri ..... 229/1.5 B X
- 3,443,741 5/1969 Stockdale ..... D9/431 X
- 5,127,817 7/1992 Weder et al. .... 425/383
- 5,339,565 8/1994 Weder et al. .... 229/1.5 B X

#### FOREIGN PATENT DOCUMENTS

- 103316 3/1938 Australia ..... 229/922

#### OTHER PUBLICATIONS

Exhibit A—Speed Cover® Brochure—The Simple Solution . . . , ©1989.

Primary Examiner—Jeffrey Asch  
Attorney, Agent, or Firm—Dunlap & Codding, P.C.

### [57] CLAIM

The ornamental design for a flower pot cover, as shown and described.

### DESCRIPTION

FIG. 1 is a perspective view of our new flower pot cover design;  
 FIG. 2 is a side elevational view thereof;  
 FIG. 3 is a top plan view thereof;  
 FIG. 4 is a bottom plan view thereof;  
 FIG. 5 is a side elevational view of the design of FIG. 1, the only difference being in the horizontal angle of the skirt;  
 FIG. 6 is a side elevational view of the design of FIG. 1, the only difference being in the vertical angle of the skirt;  
 FIG. 7 is a side elevational view of the design of FIG. 1, the only difference being in the downward angle of the skirt;  
 FIG. 8 is a perspective view of a second embodiment of our new flower pot cover design;  
 FIG. 9 is a side elevational view thereof;  
 FIG. 10 is a top plan view thereof;

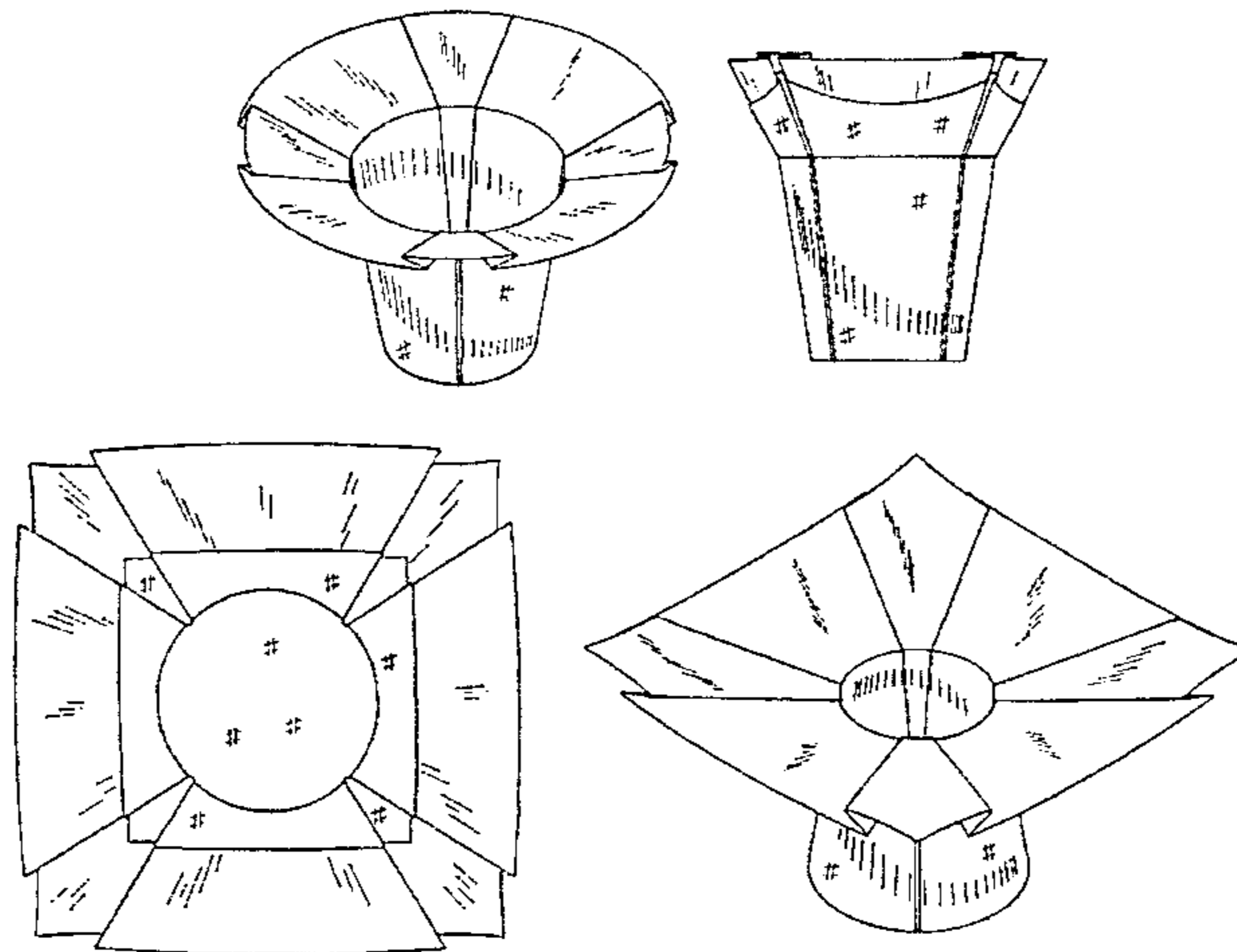

FIG. 11 is a bottom plan view thereof;  
FIG. 12 is a side elevational view of the design of FIG. 8, the only difference being in the horizontal angle of the skirt;  
FIG. 13 is a side elevational view of the design of FIG. 8, the only difference being in the vertical angle of the skirt;  
FIG. 14 is a side elevational view of the design of FIG. 8, the only difference being in the downward angle of the skirt;  
FIG. 15 is a perspective view of a third embodiment of our new flower pot cover design;  
FIG. 16 is a side elevational view thereof;  
FIG. 17 is a top plan view thereof;  
FIG. 18 is a bottom plan view thereof;  
FIG. 19 is a side elevational view of the design of FIG. 15, the only difference being in the horizontal angle of the skirt;  
FIG. 20 is a side elevational view of the design of FIG. 15, the only difference being in the vertical angle of the skirt;  
FIG. 21 is a side elevational view of the design of FIG. 15, the only difference being in the downward angle of the skirt;  
FIG. 22 is a perspective view of a fourth embodiment of our new flower pot cover design;  
FIG. 23 is a side elevational view thereof;  
FIG. 24 is a top plan view thereof;  
FIG. 25 is a bottom plan view thereof;

FIG. 26 is a side elevational view of the design of FIG. 22, the only difference being in the horizontal angle of the skirt;  
FIG. 27 is a side elevational view of the design of FIG. 22, the only difference being in the vertical angle of the skirt;  
FIG. 28 is a side elevational view of the design of FIG. 22, the only difference being in the downward angle of the skirt;  
FIG. 29 is a perspective view of a fifth embodiment of our new flower pot cover design;  
FIG. 30 is a side elevational view thereof;  
FIG. 31 is a top plan view thereof;  
FIG. 32 is a bottom plan view thereof;  
FIG. 33 is a side elevational view of the design of FIG. 29, the only difference being in the horizontal angle of the skirt;  
FIG. 34 is a side elevational view of the design of FIG. 29, the only difference being in the vertical angle of the skirt, and;  
FIG. 35 is a side elevational view of the design of FIG. 29, the only difference being in the downward angle of the skirt.  
The crosshatching on specific portions of the flower pot cover is indicative of varying surface effects.  
The flower pot cover has no substantial thickness.

**1 Claim, 7 Drawing Sheets**

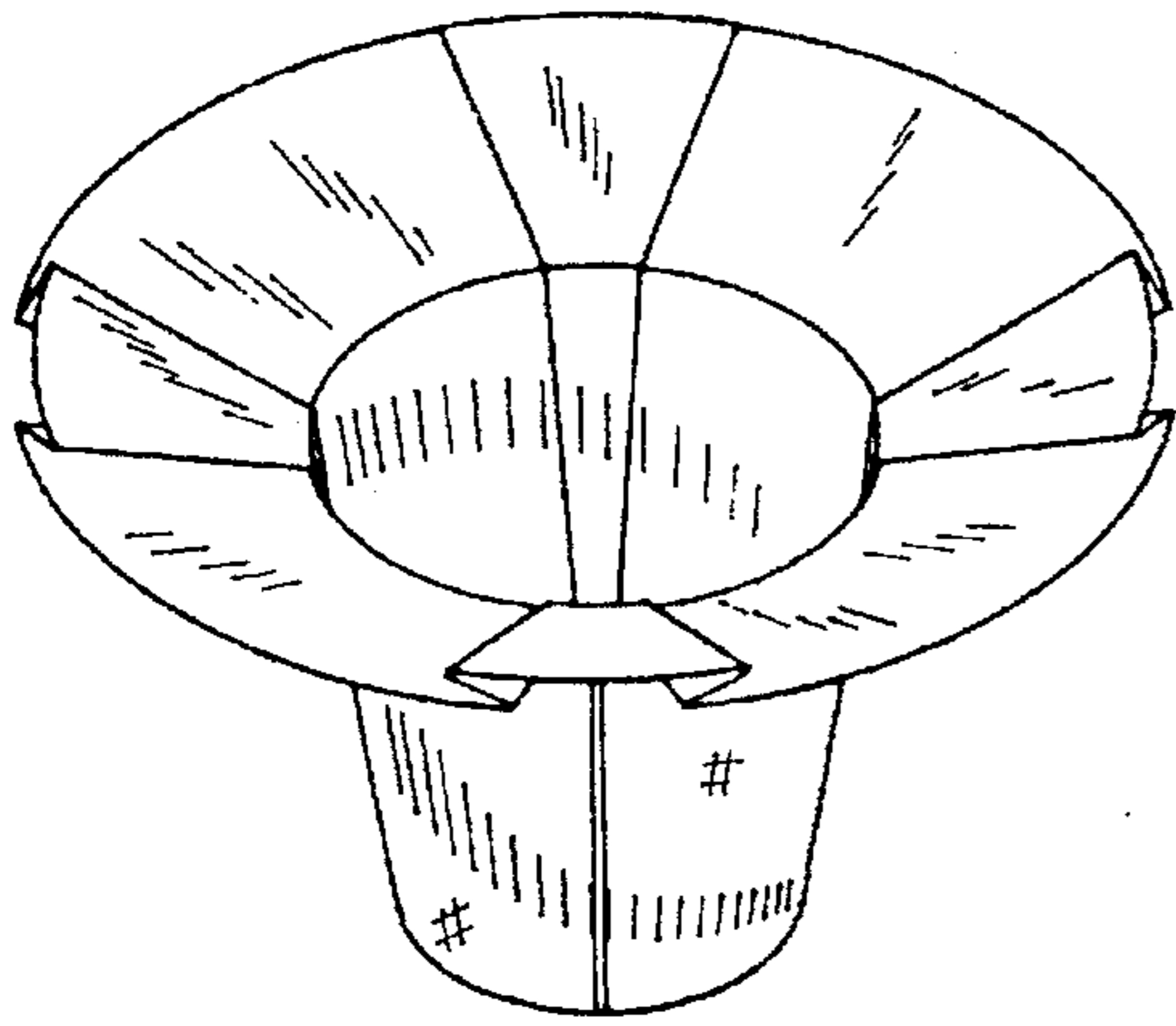

FIG. 1

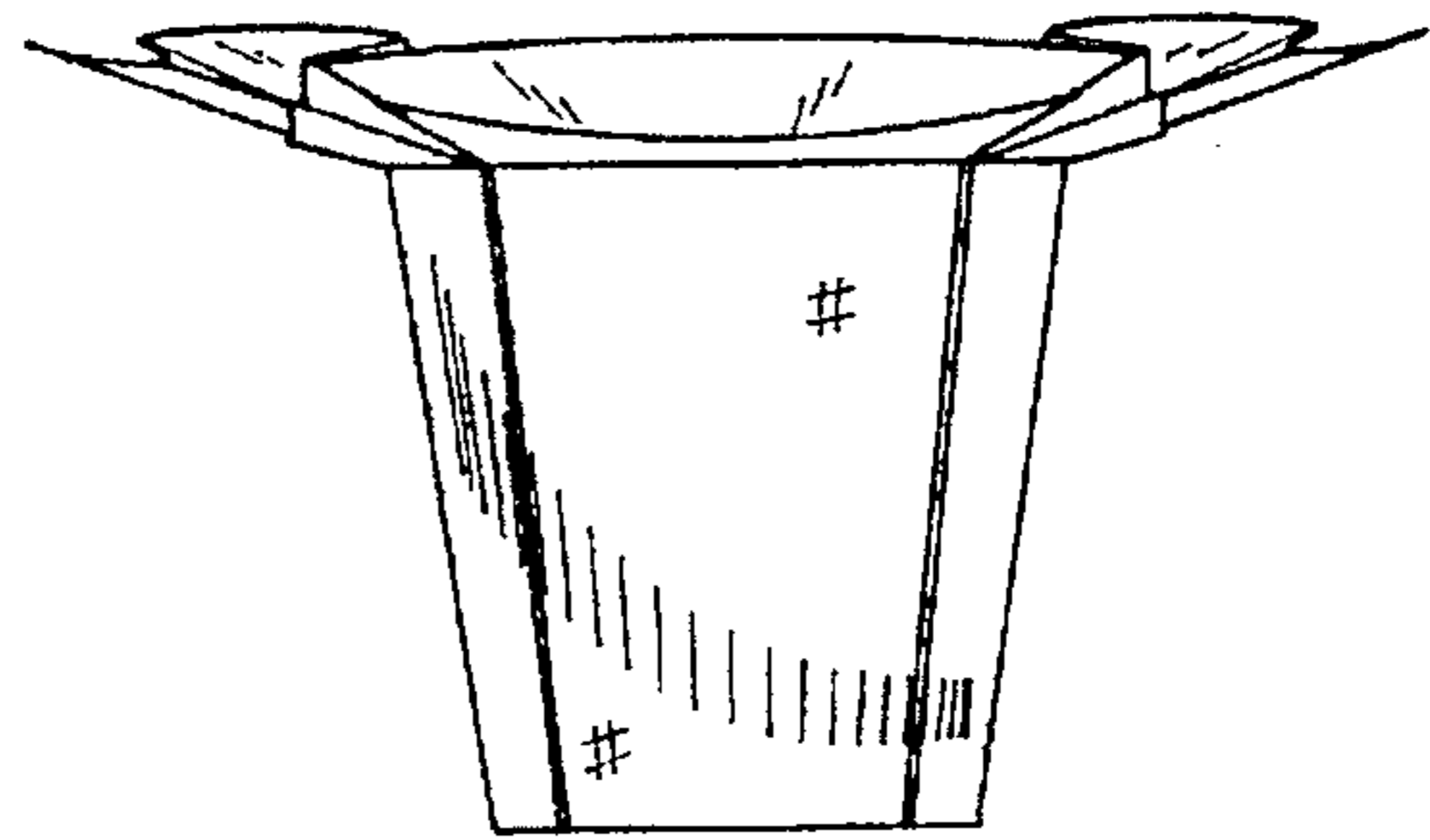

FIG. 2

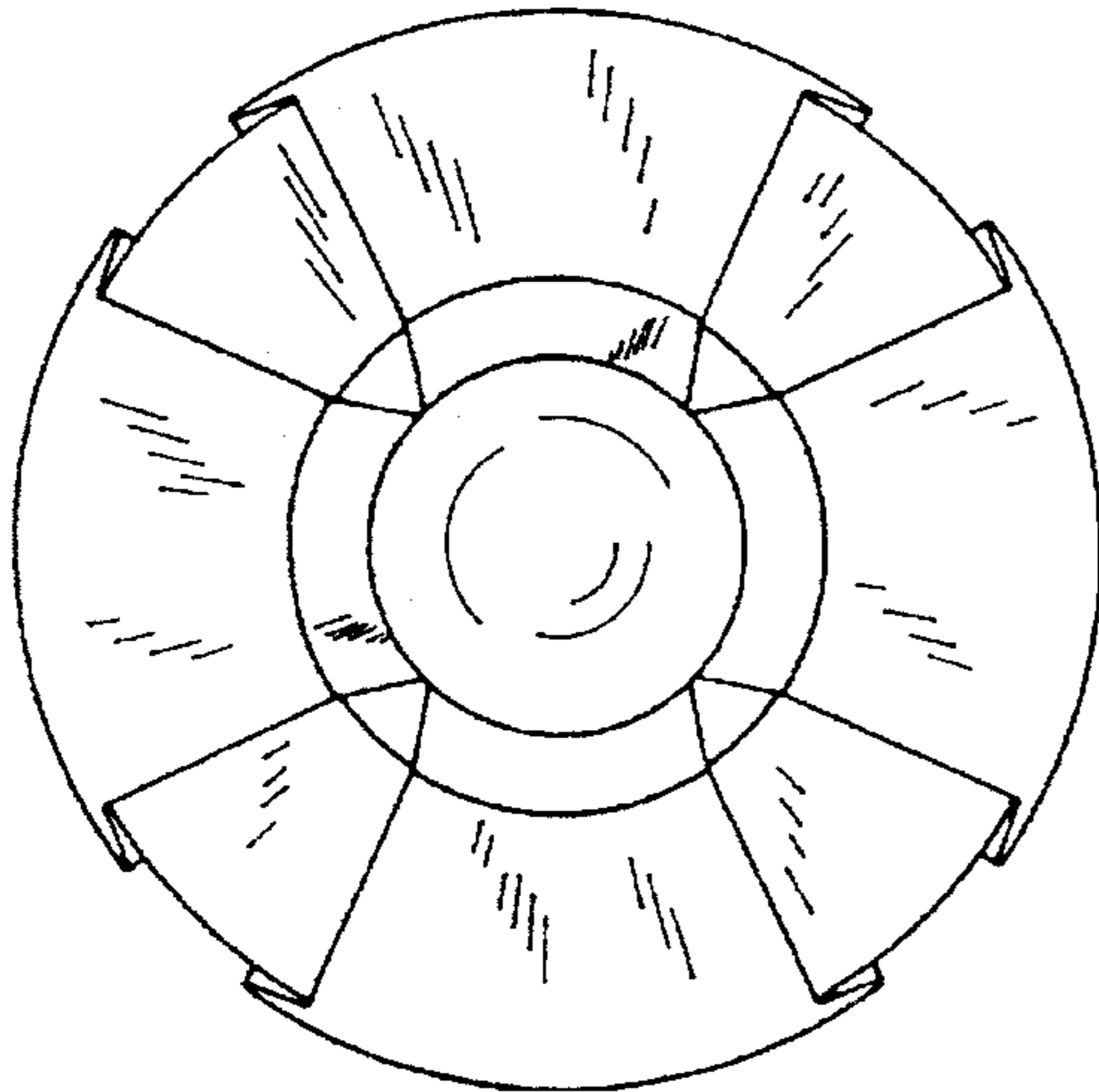

FIG. 3

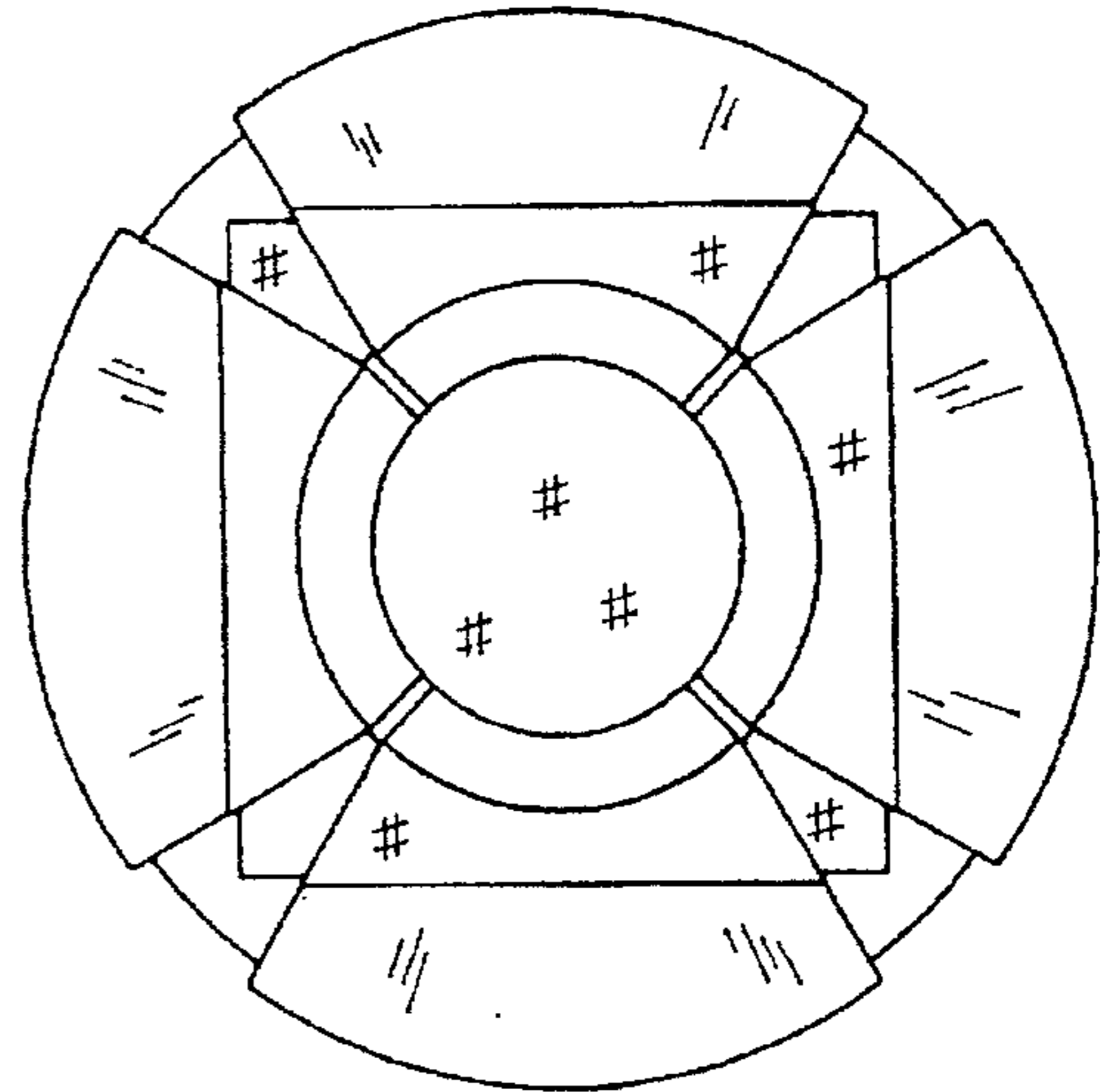

FIG. 4

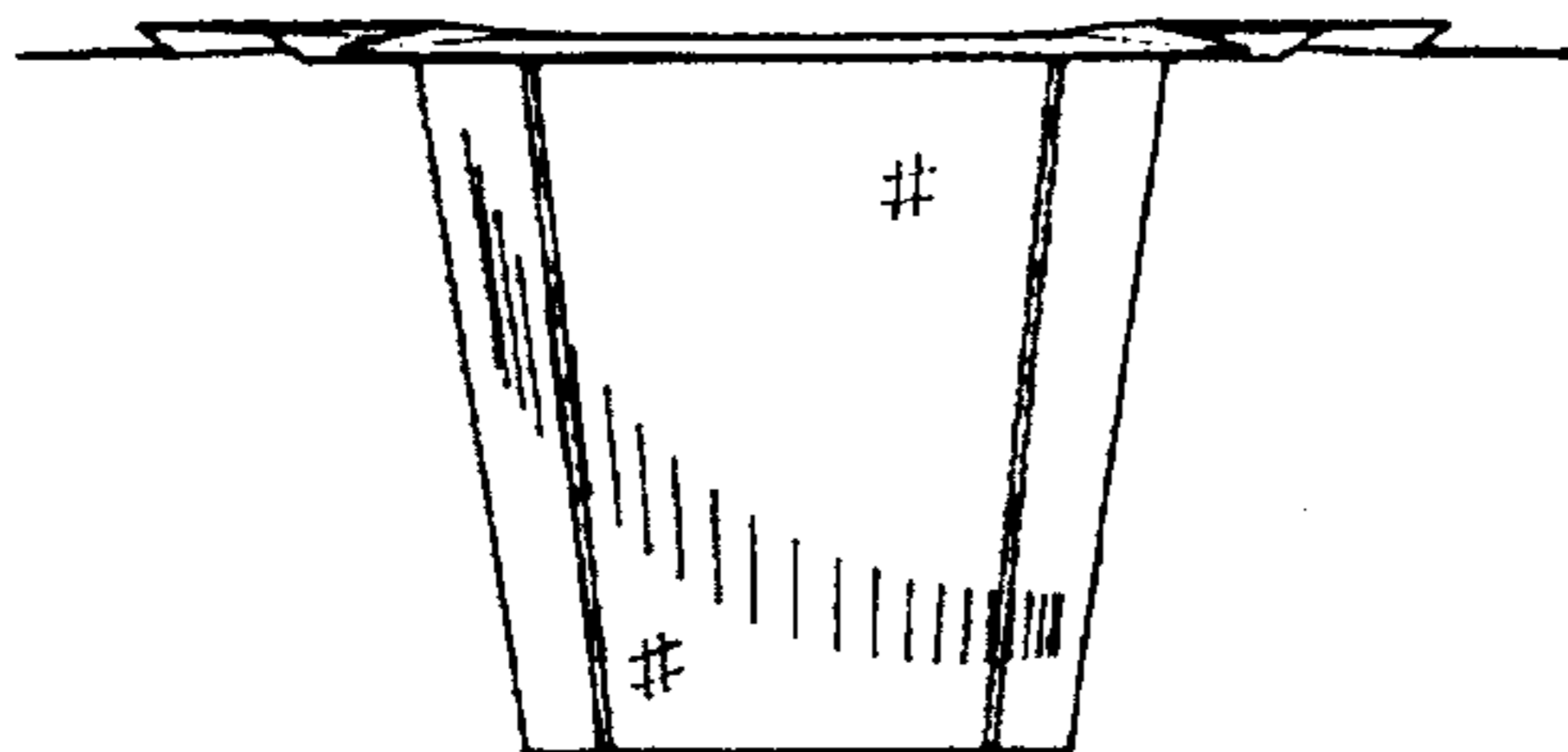

FIG. 5

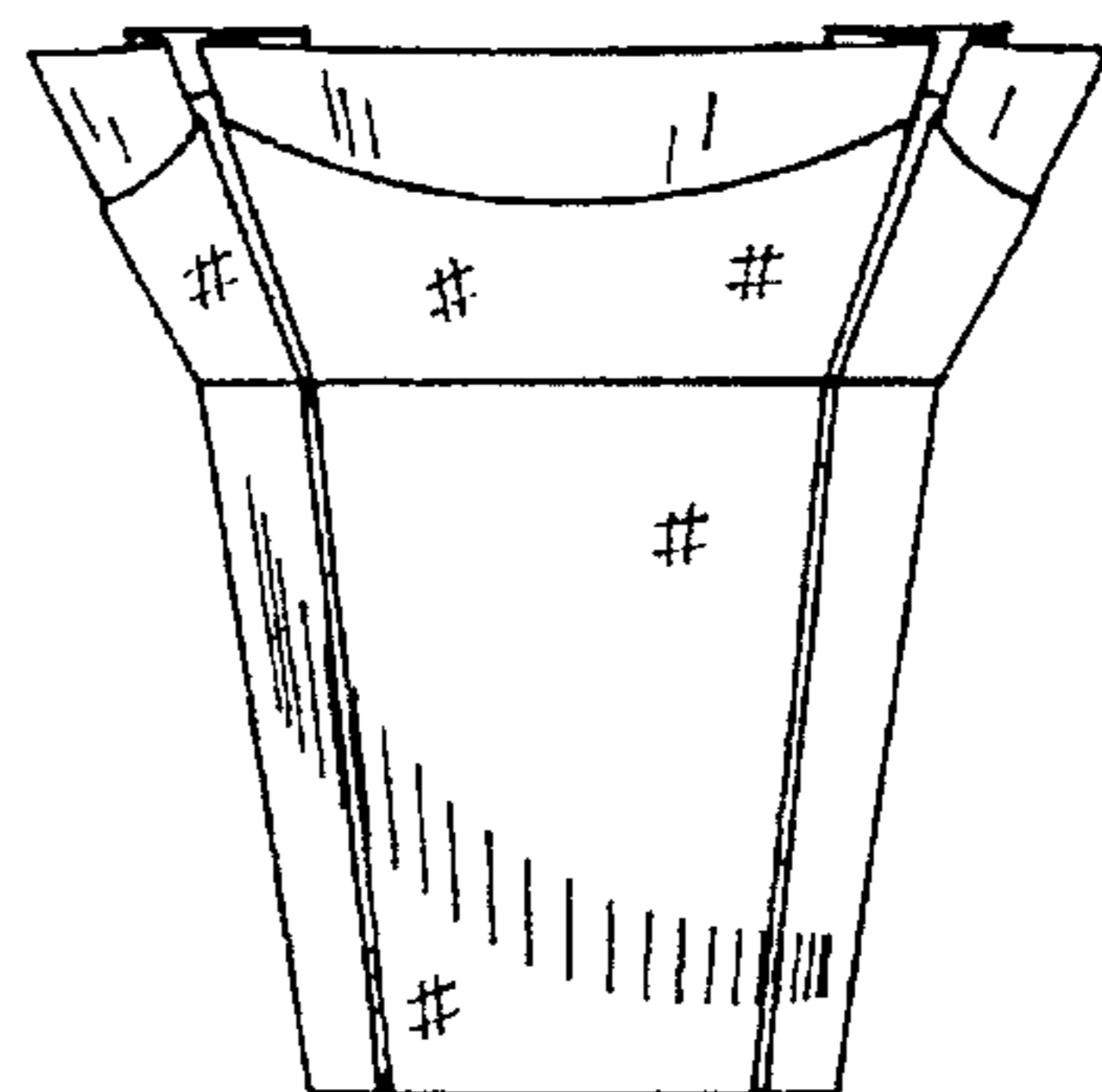

FIG. 6

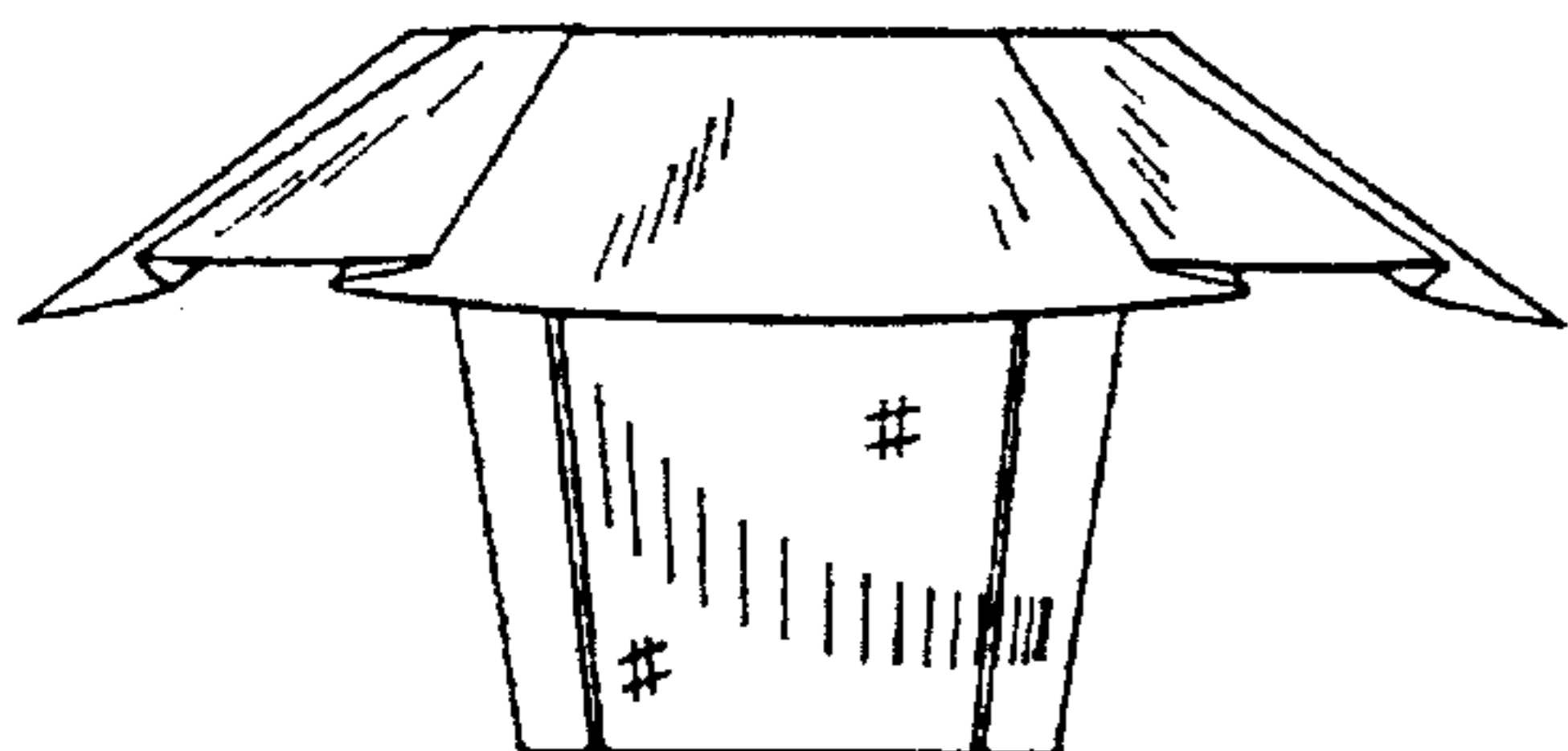

FIG. 7

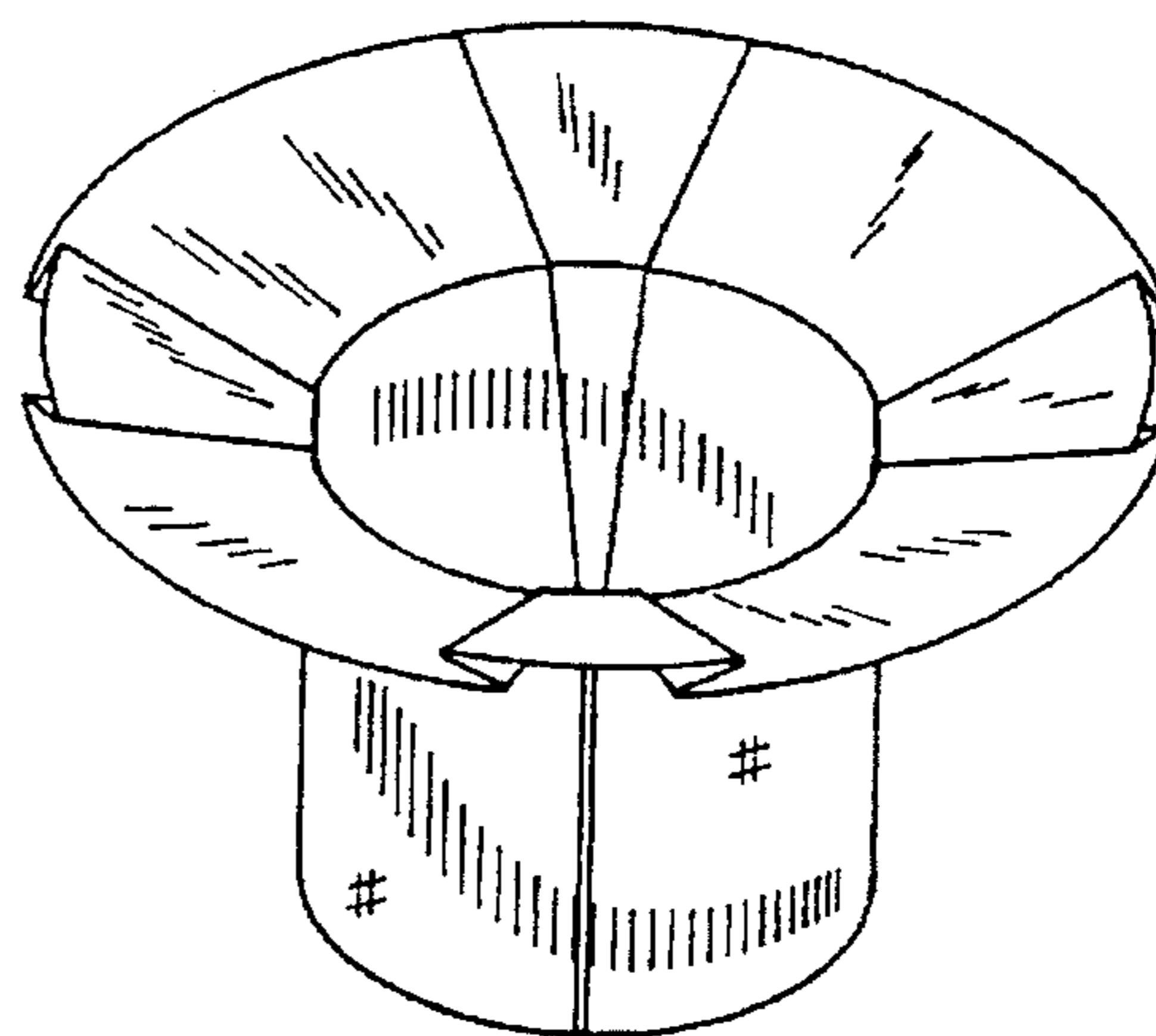

FIG. 8

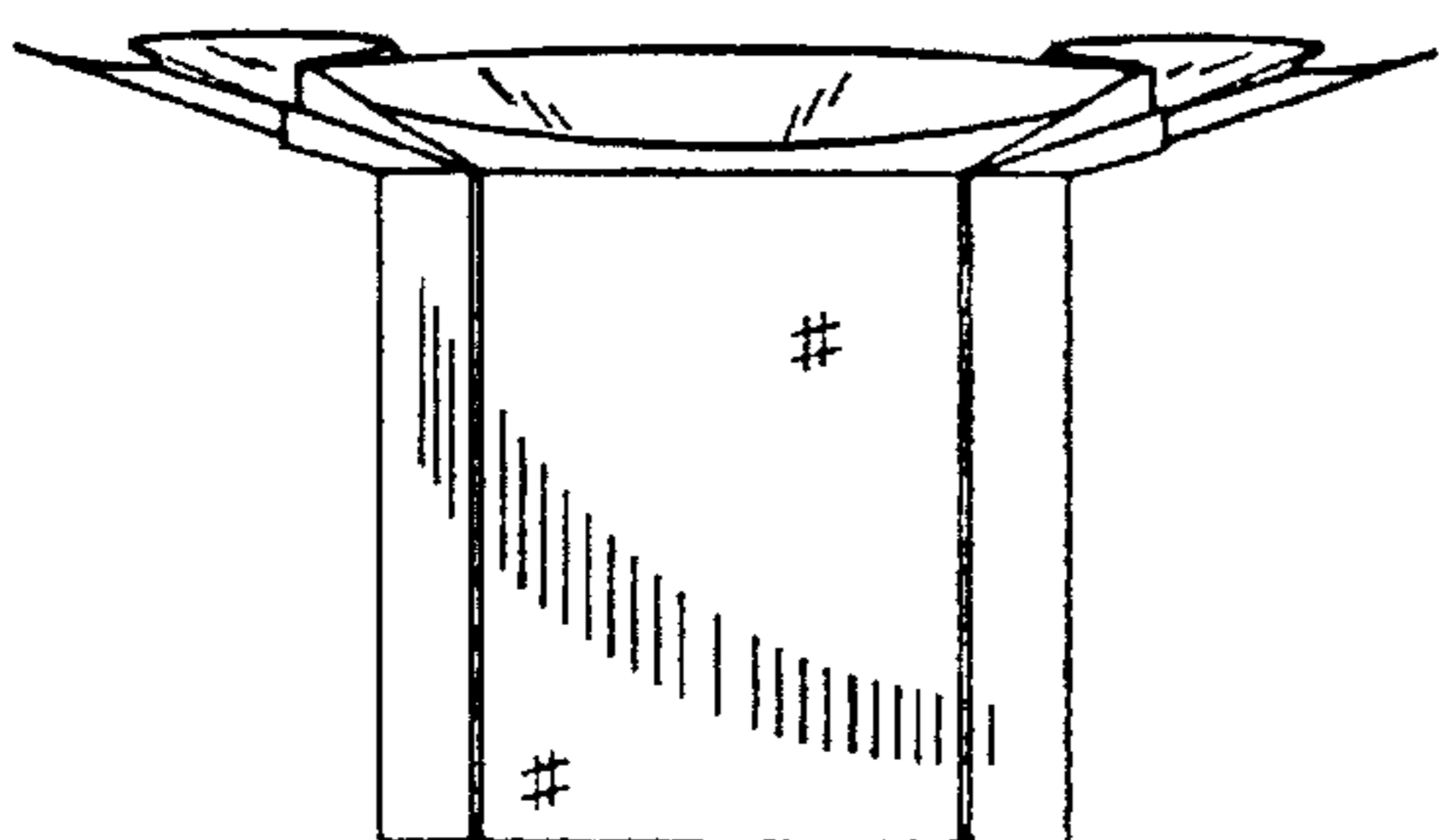

FIG. 9

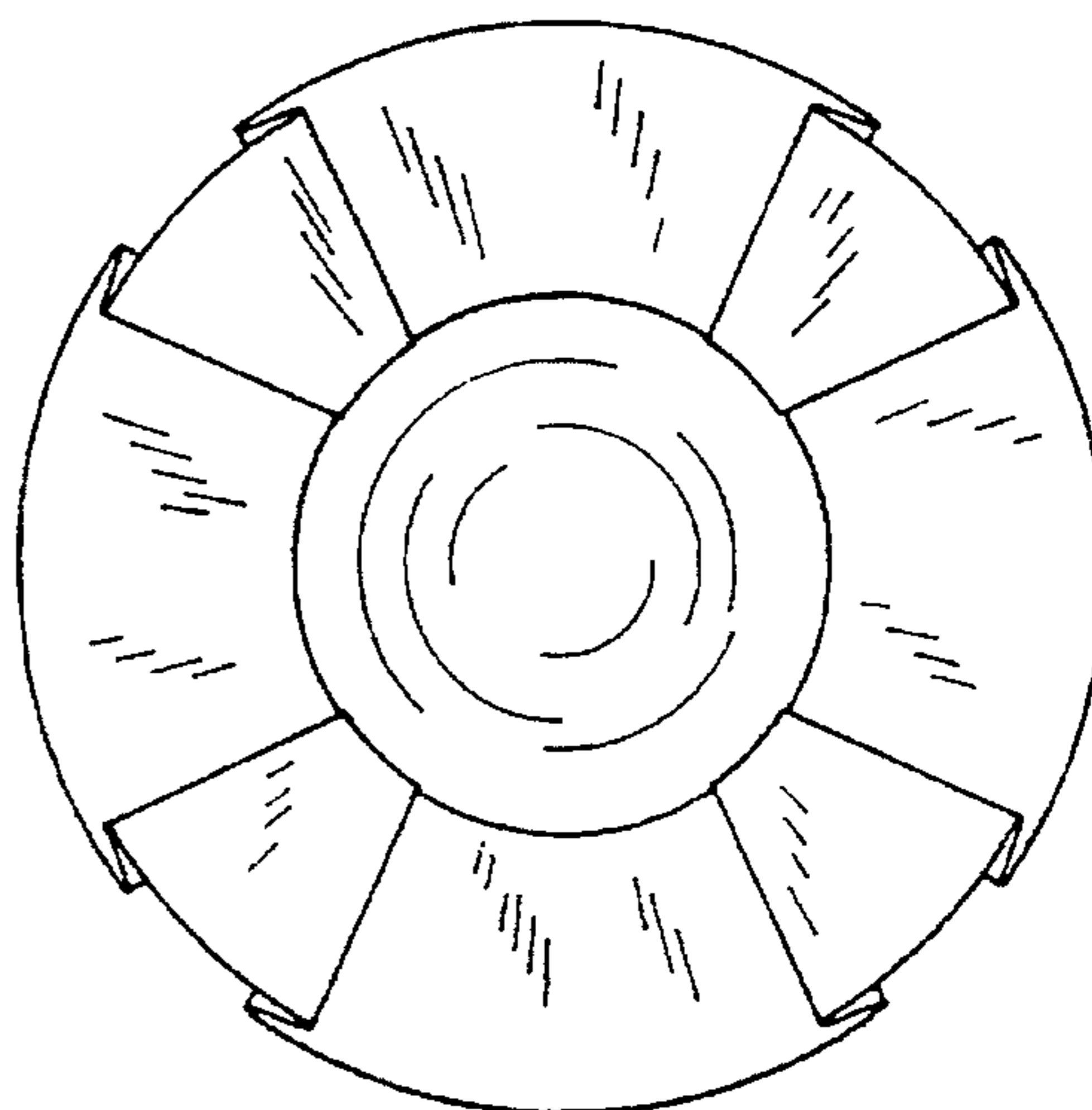

FIG. 10

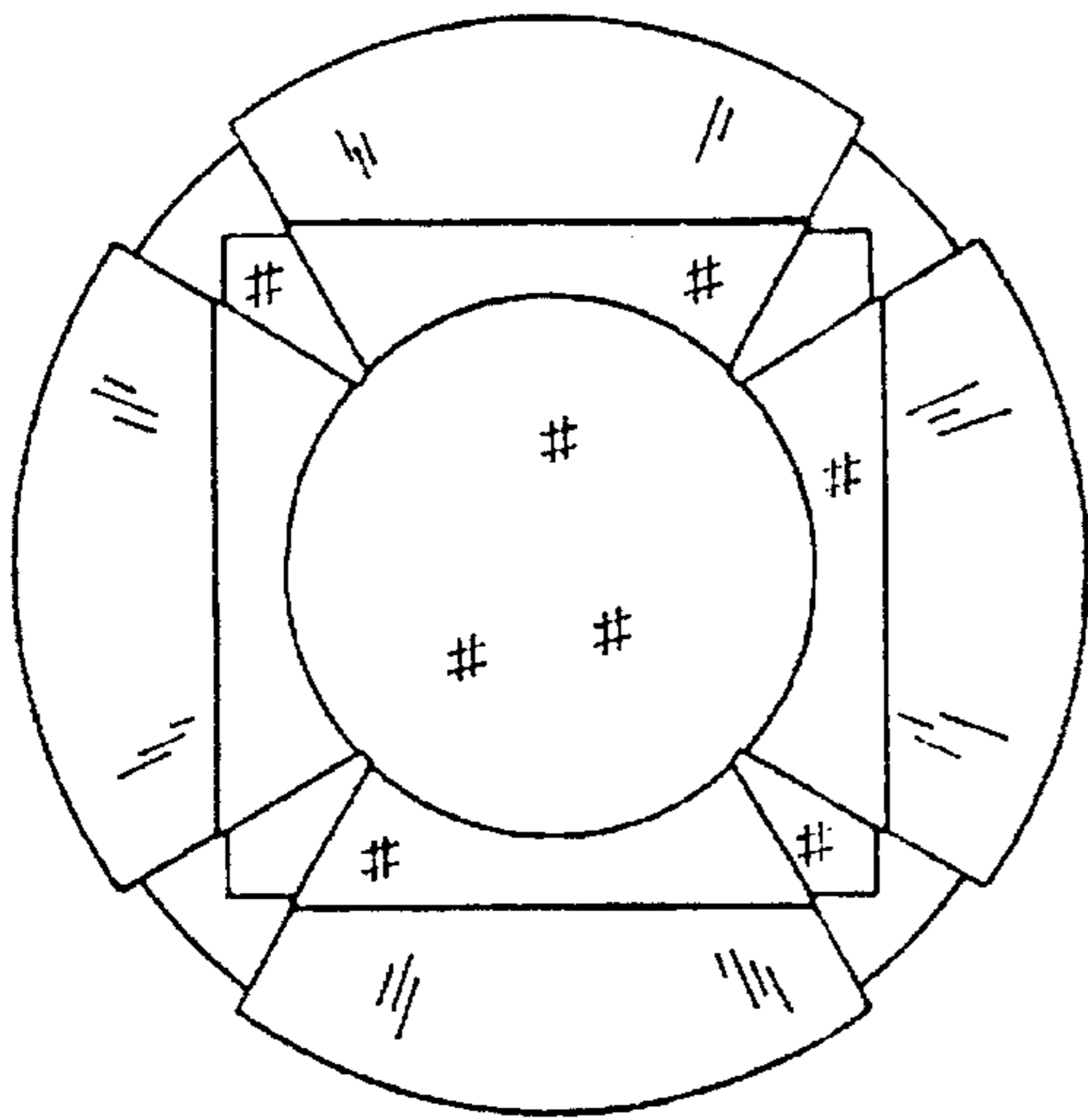

FIG. 11

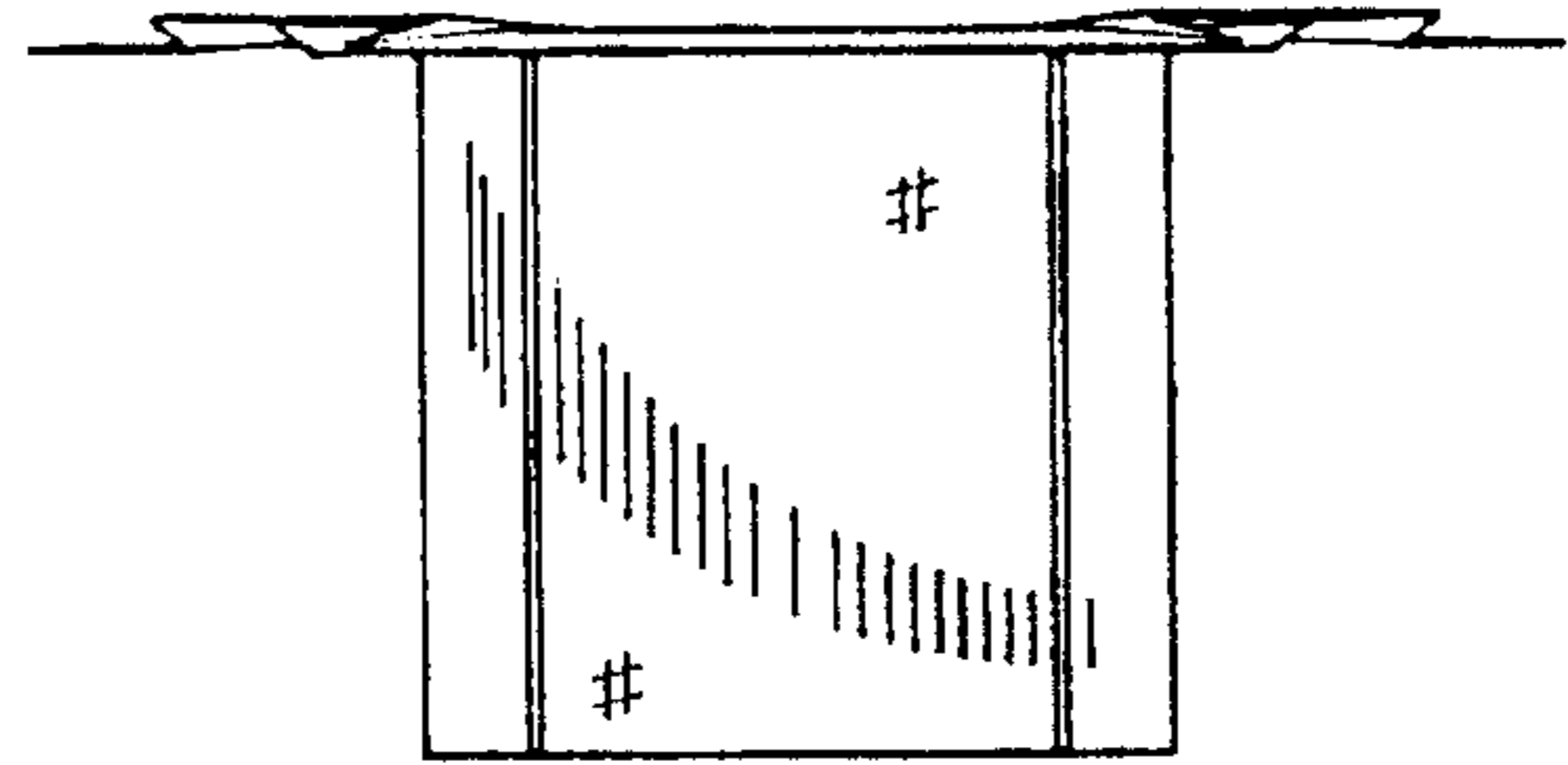

FIG. 12

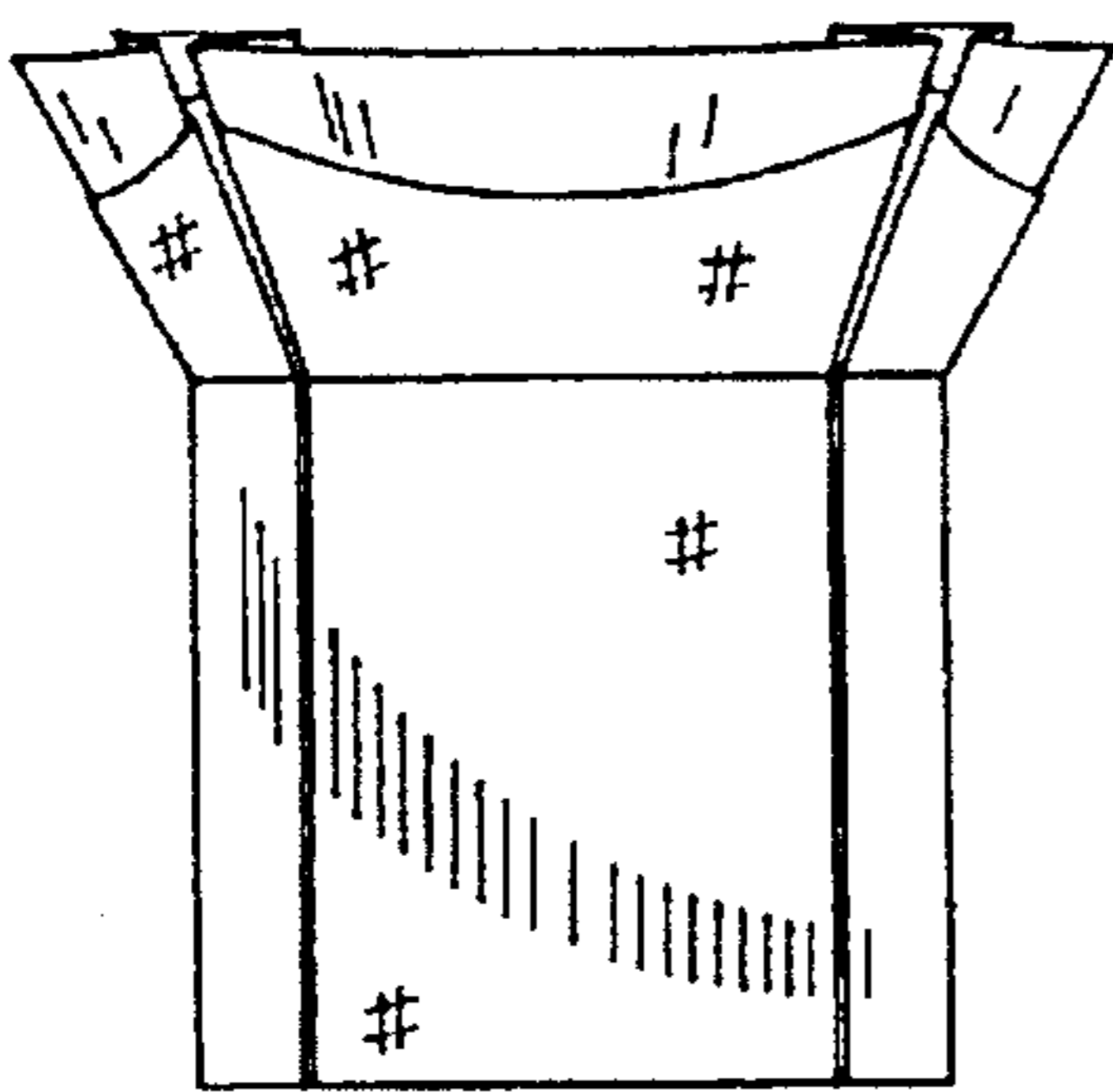

FIG. 13

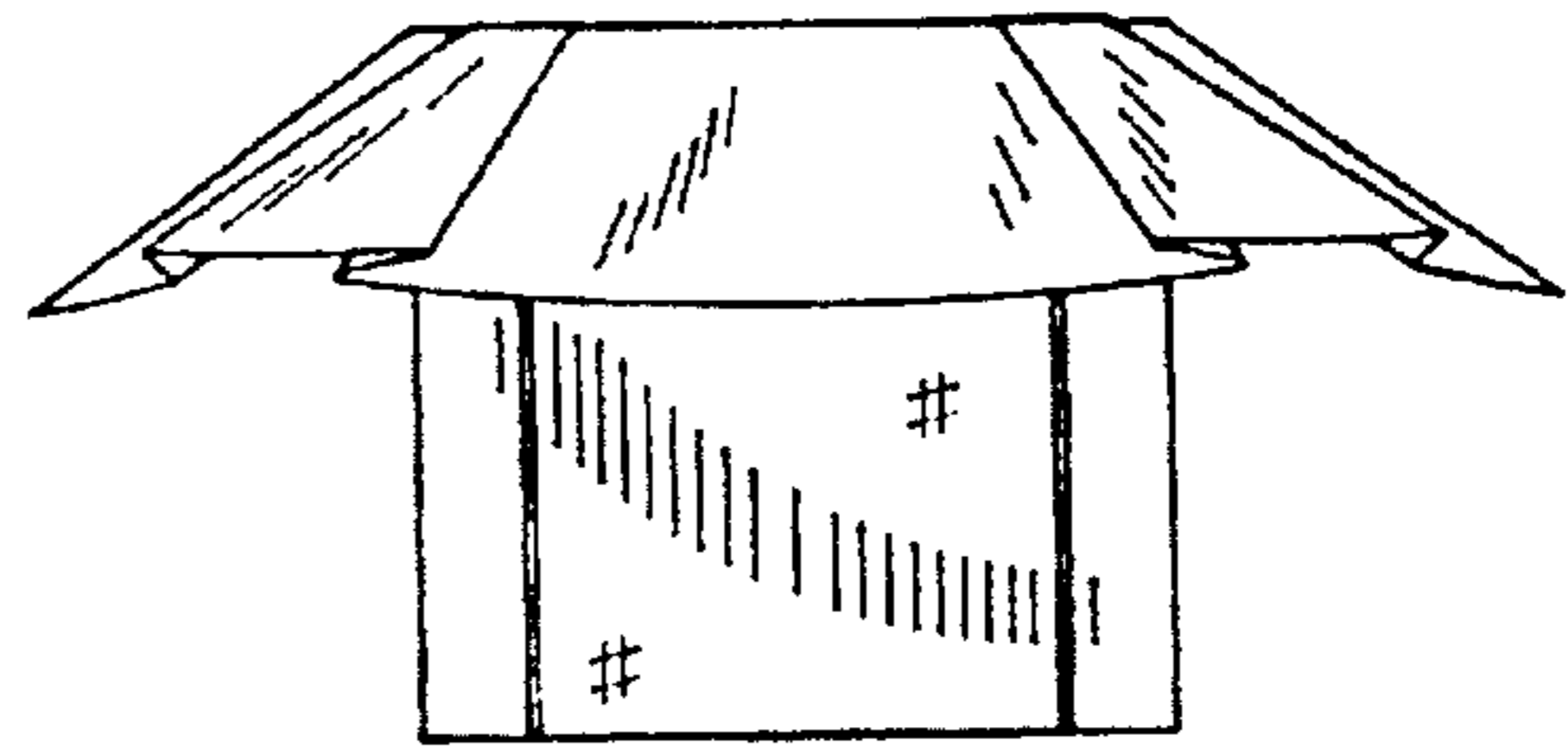

FIG. 14

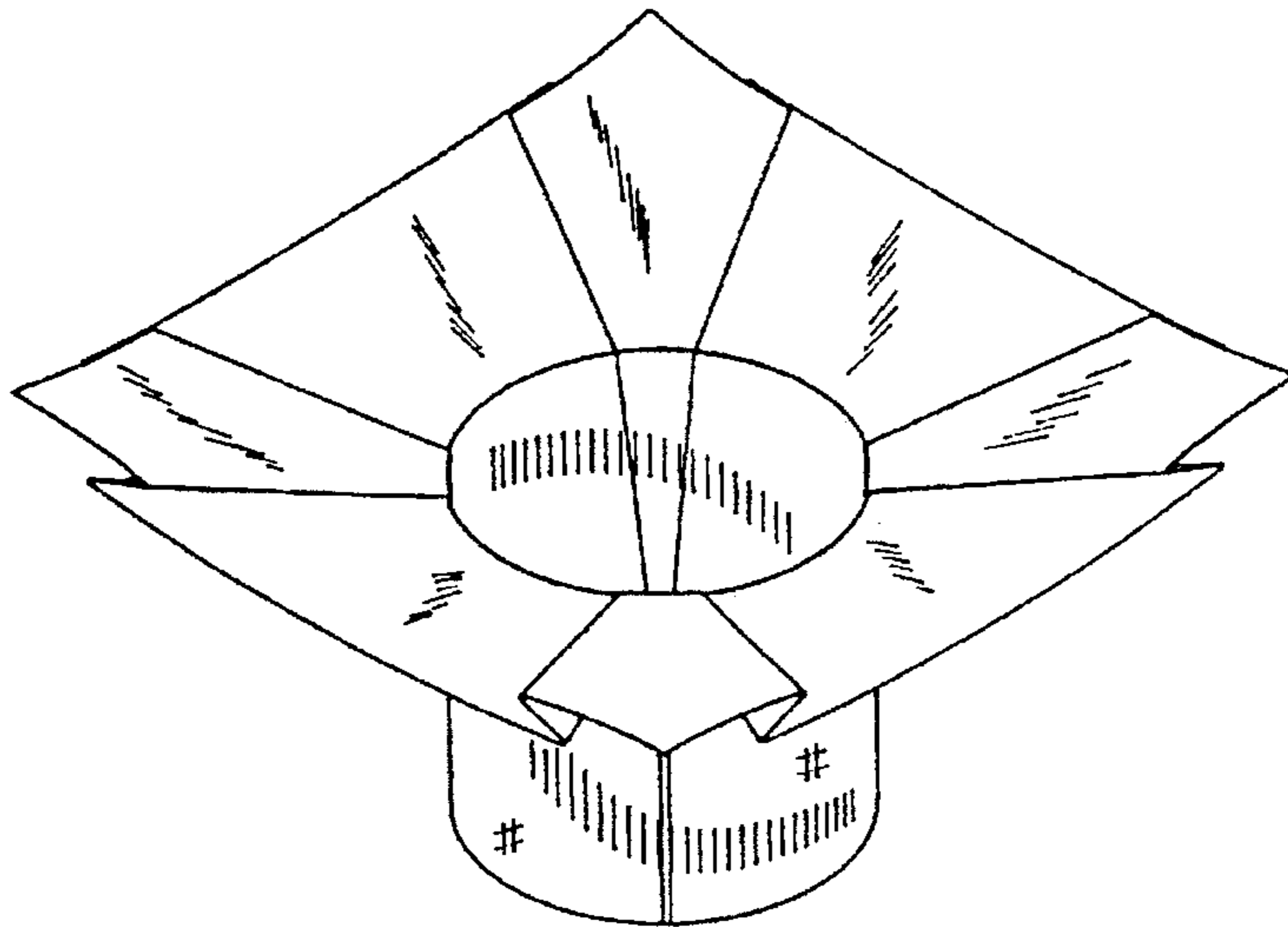

FIG. 15

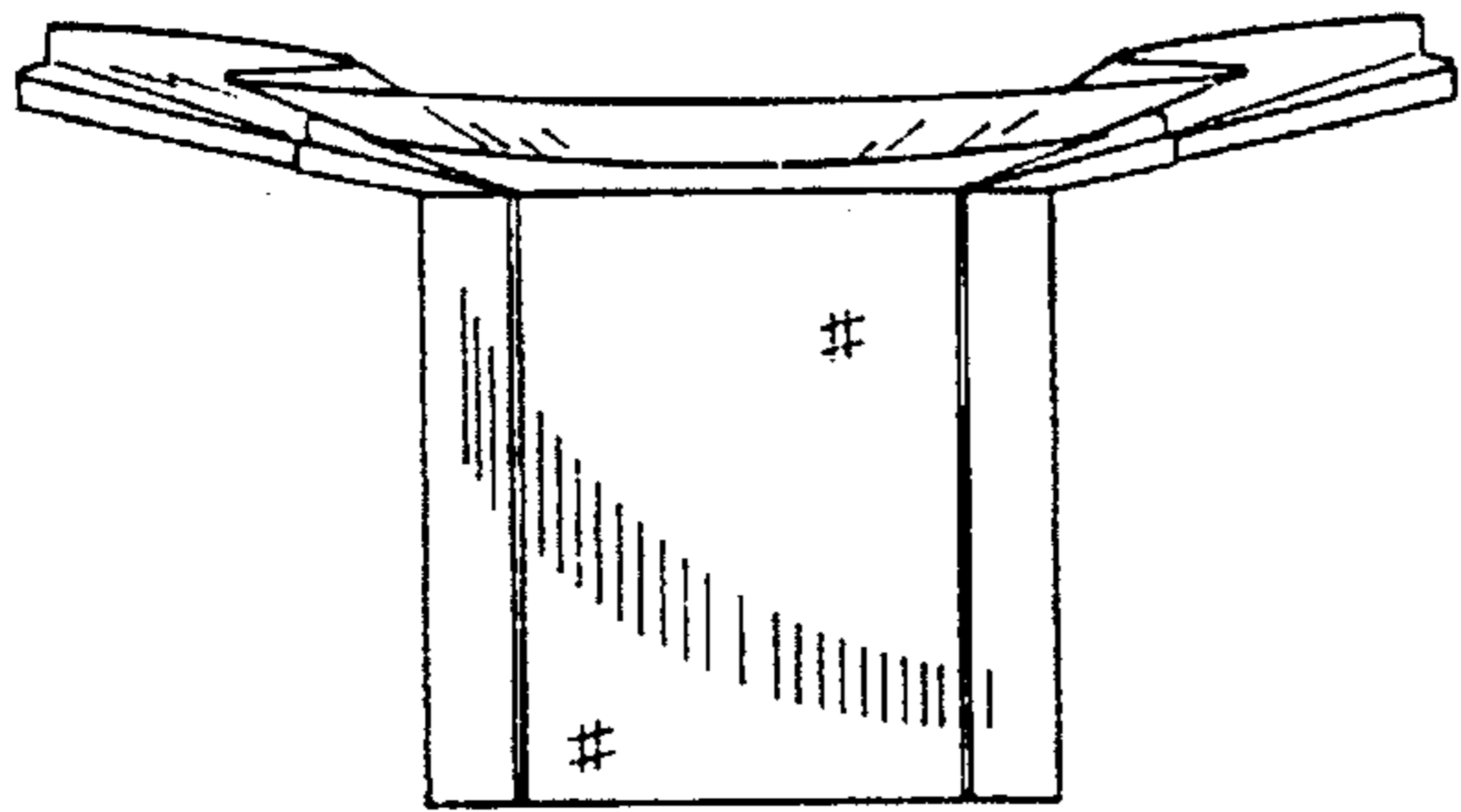

FIG. 16

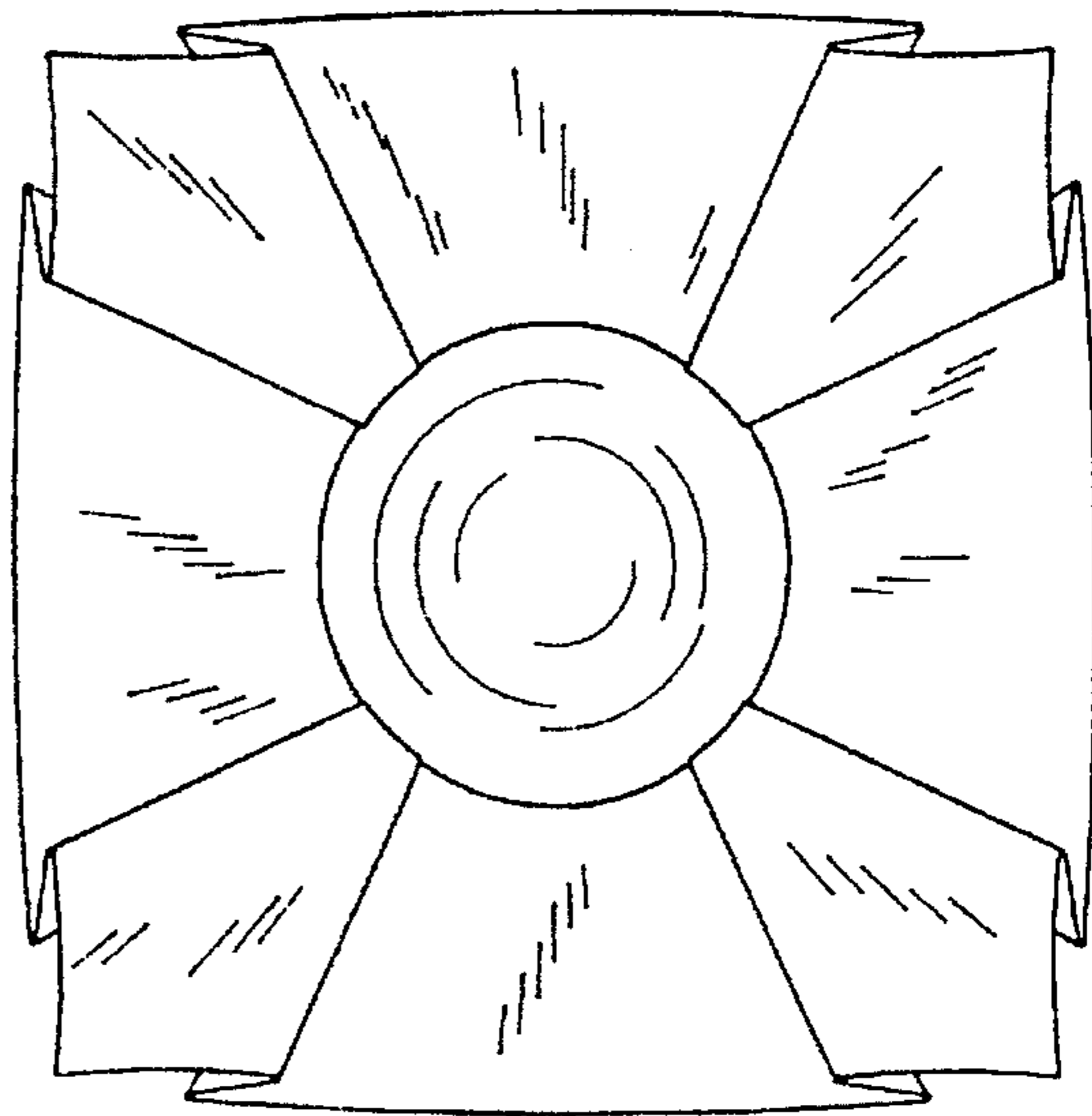

FIG. 17

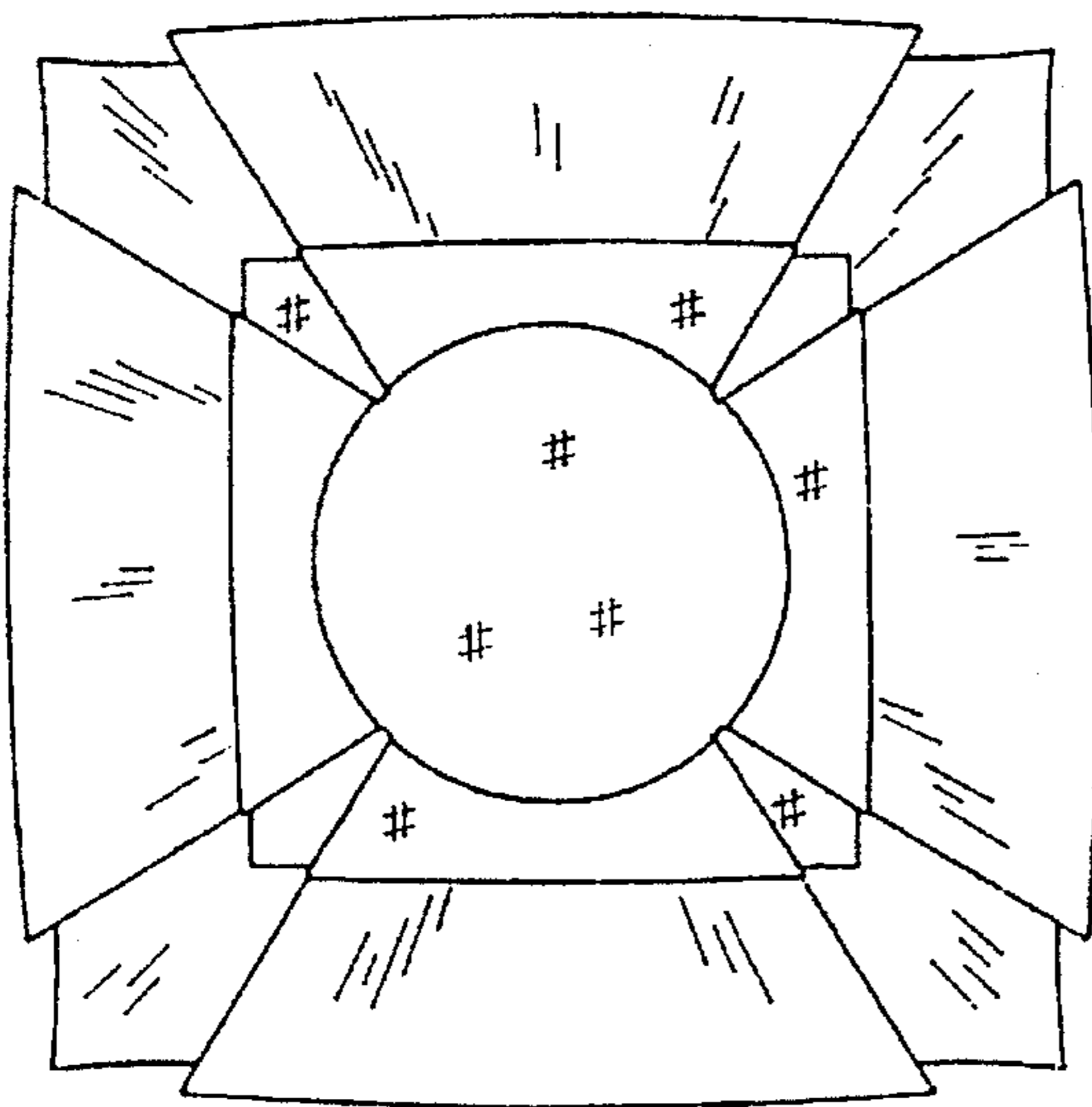

FIG. 18

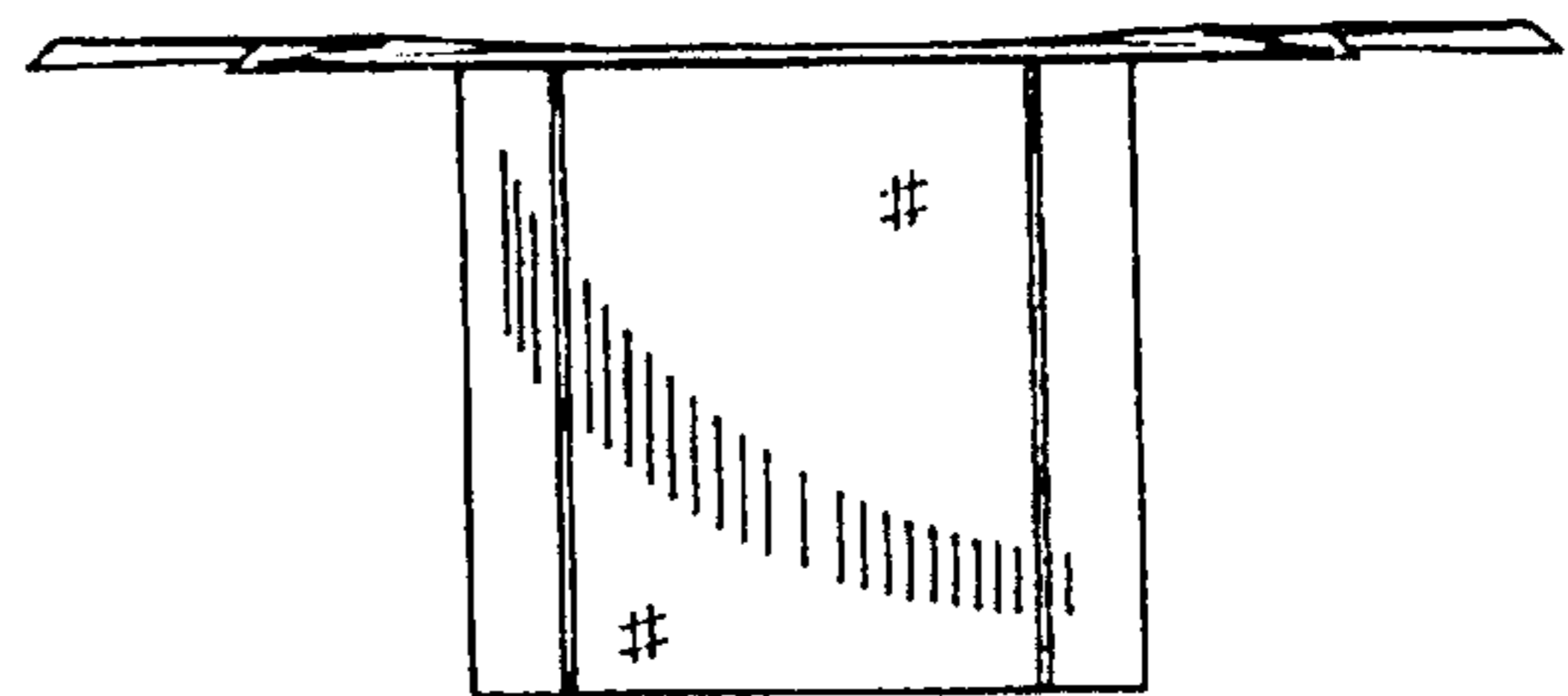

FIG. 19

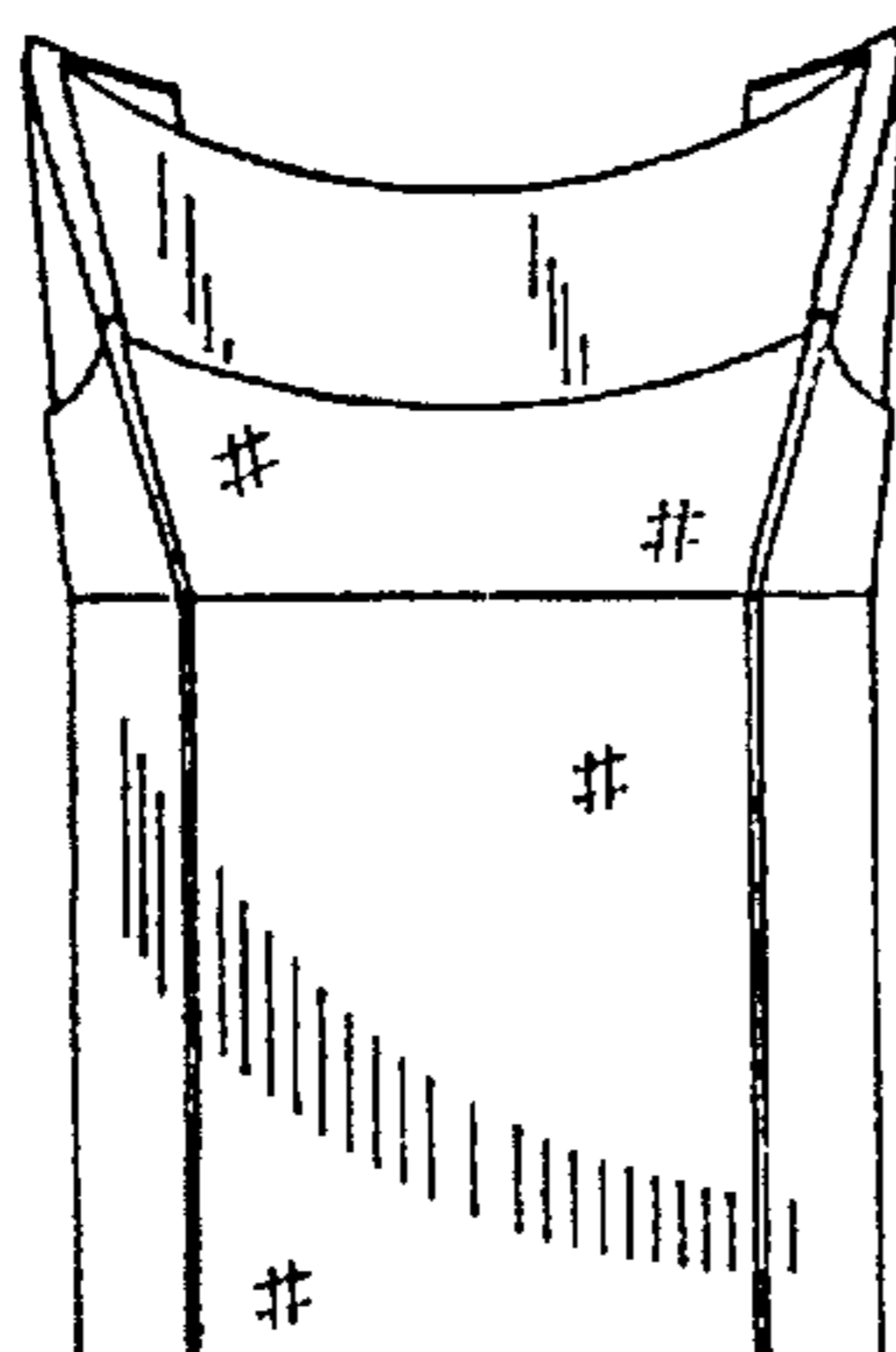

FIG. 20

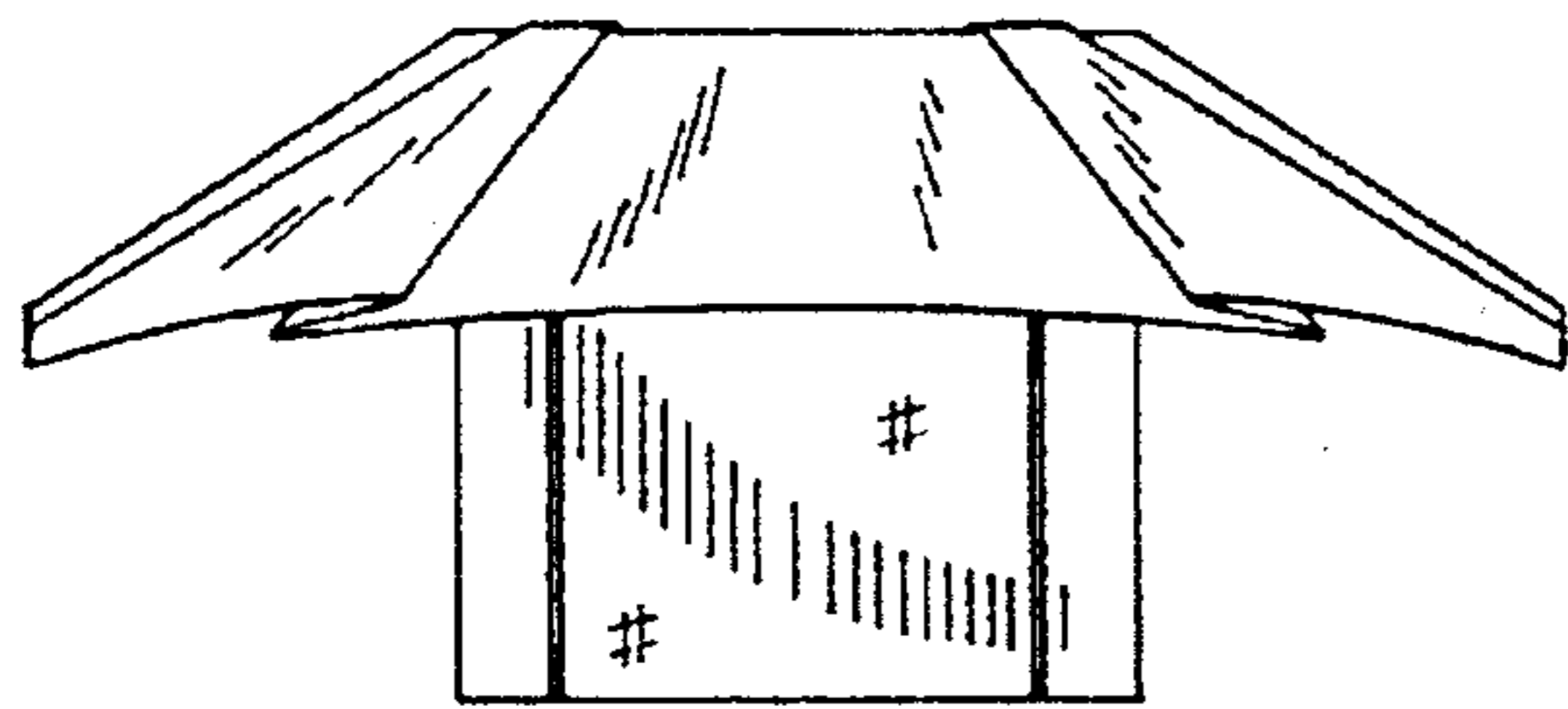

FIG. 21

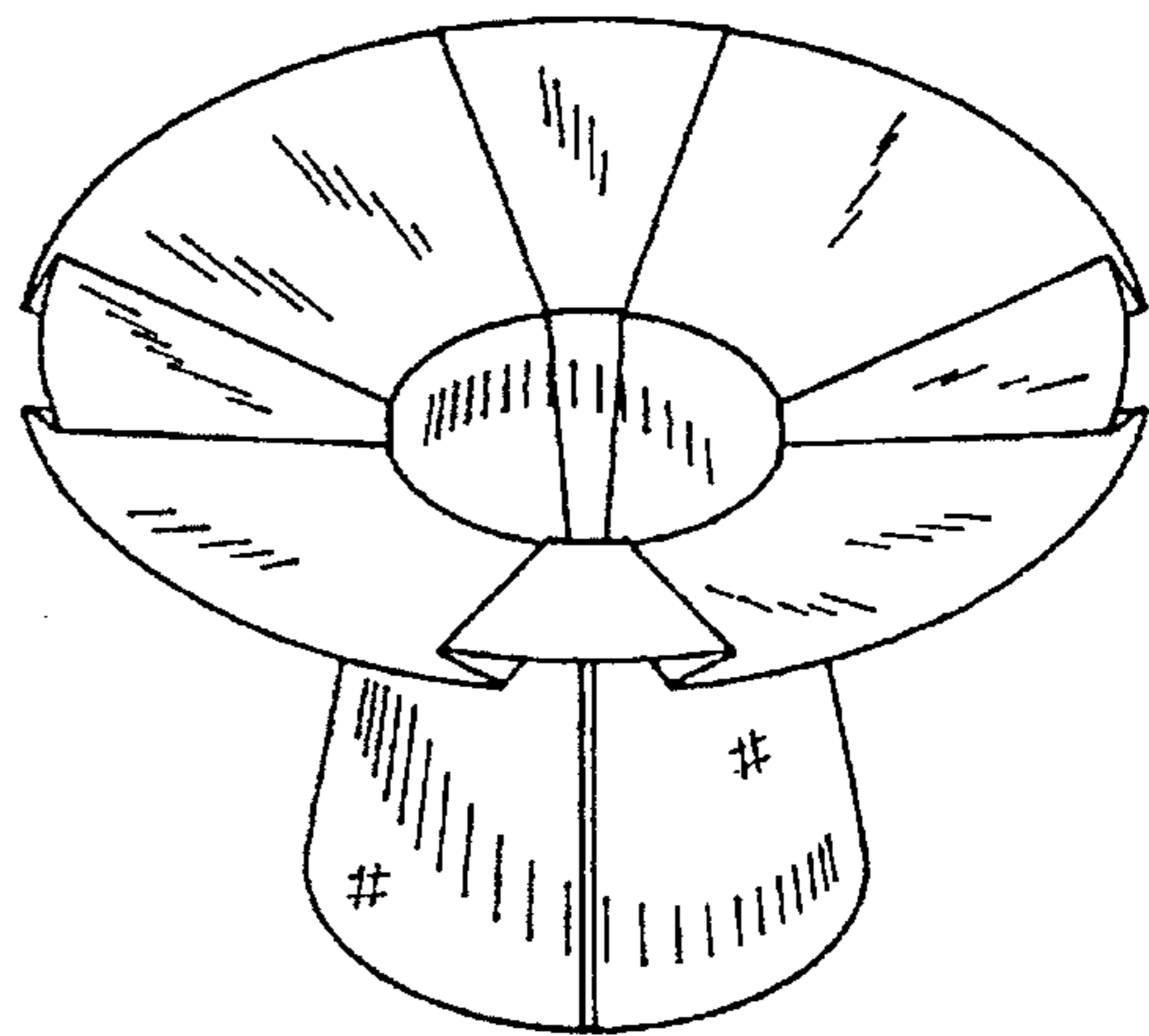

FIG. 22

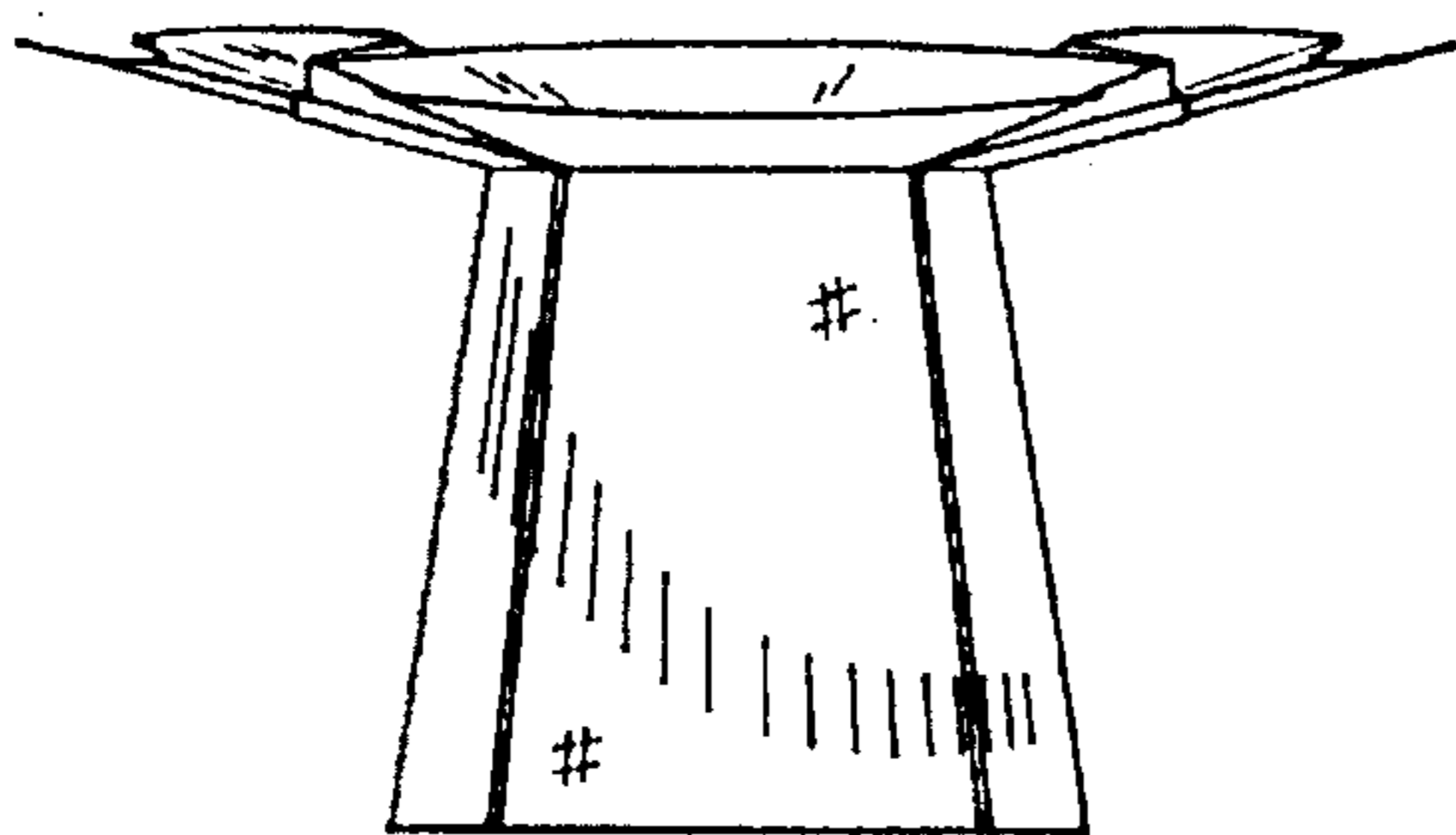

FIG. 23

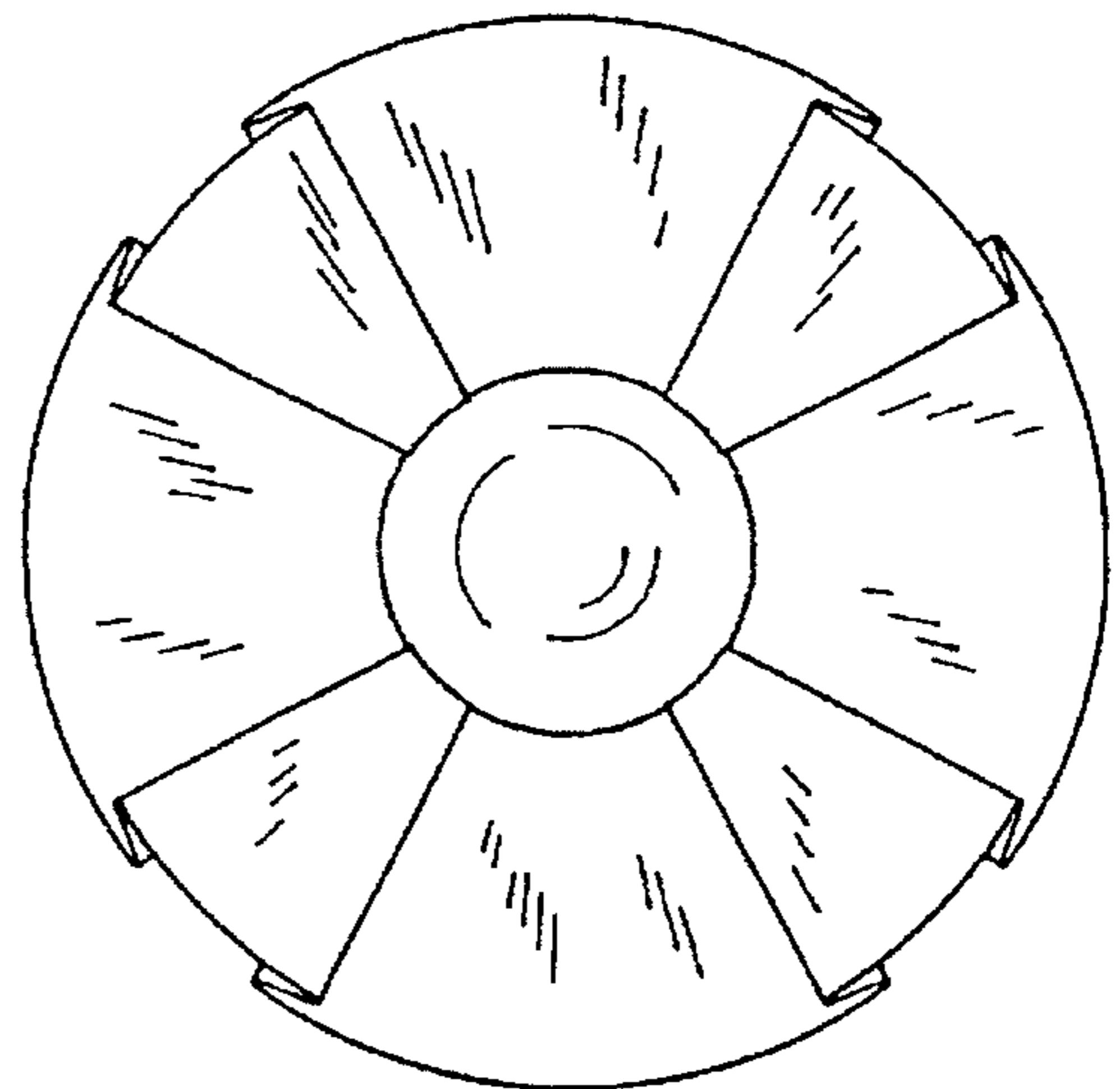

FIG. 24

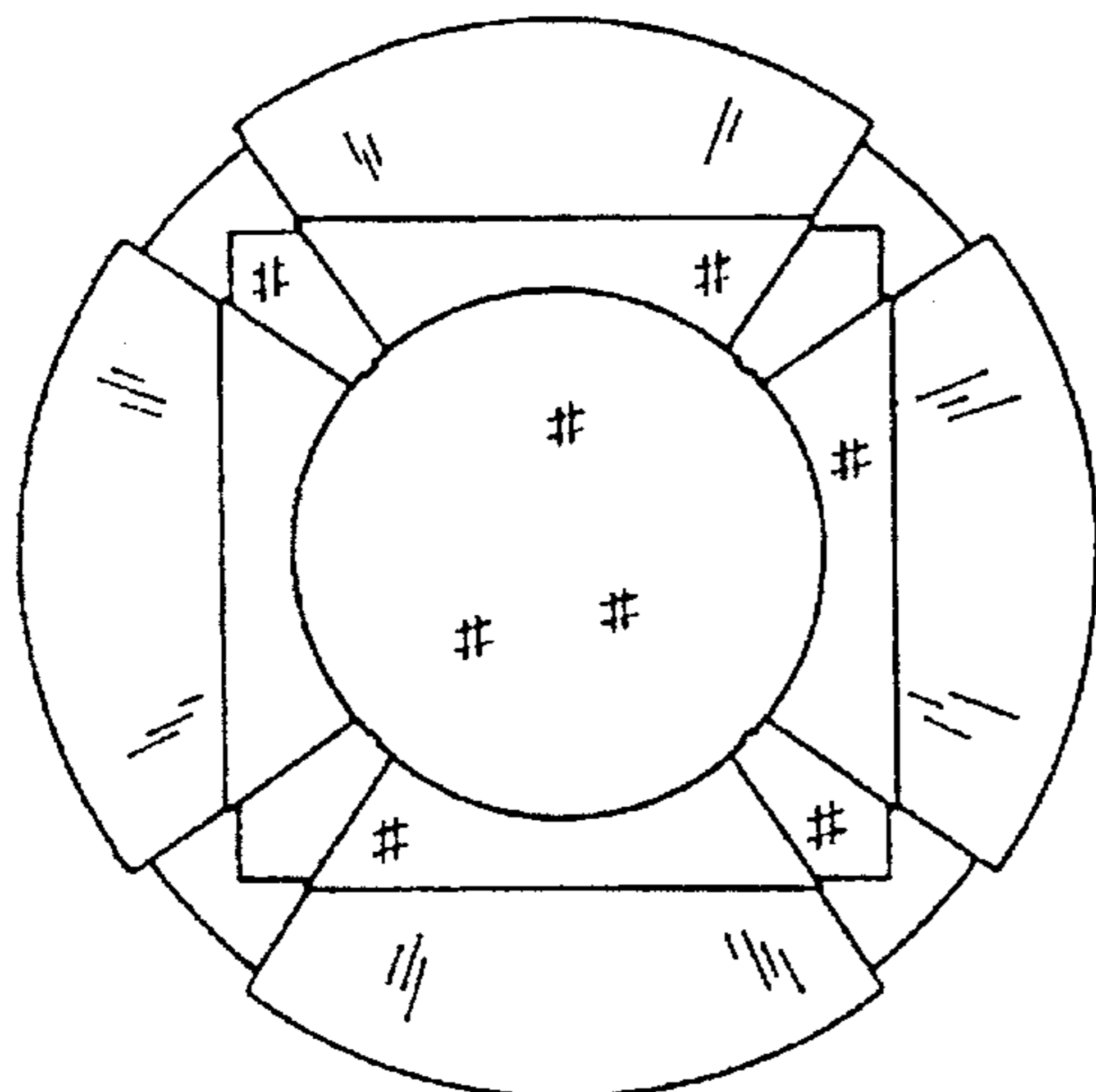

FIG. 25

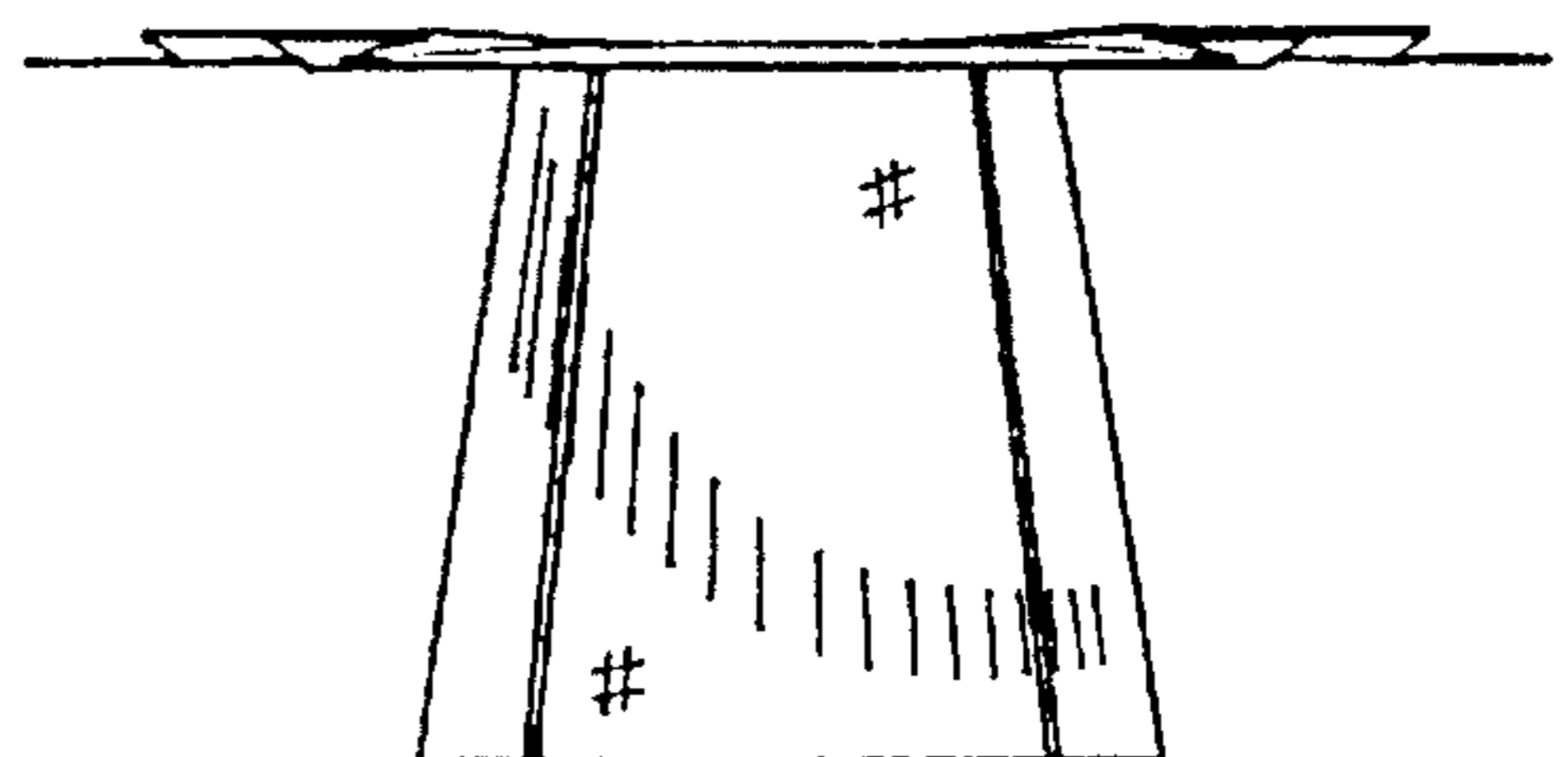

FIG. 26

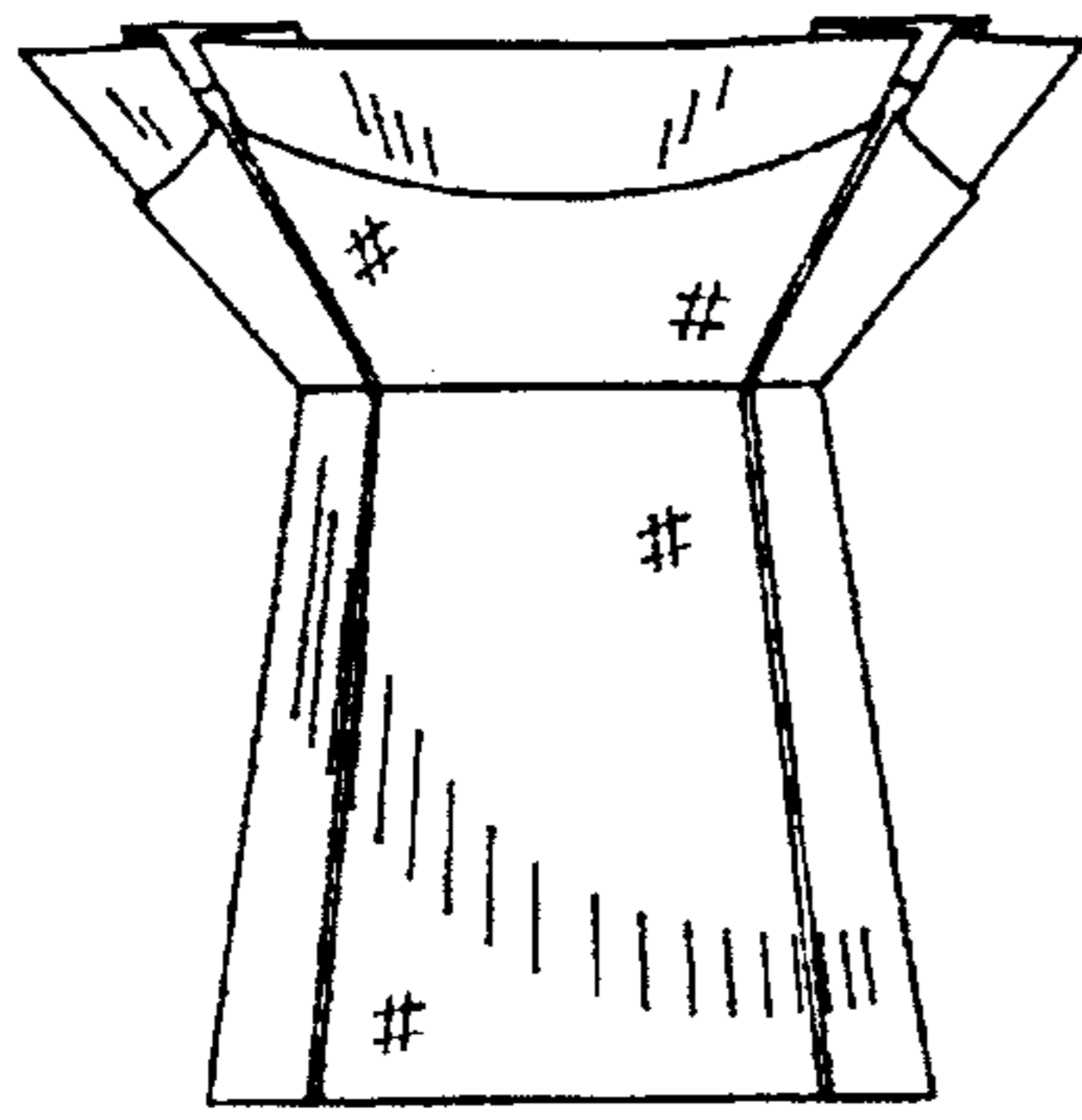

FIG. 27

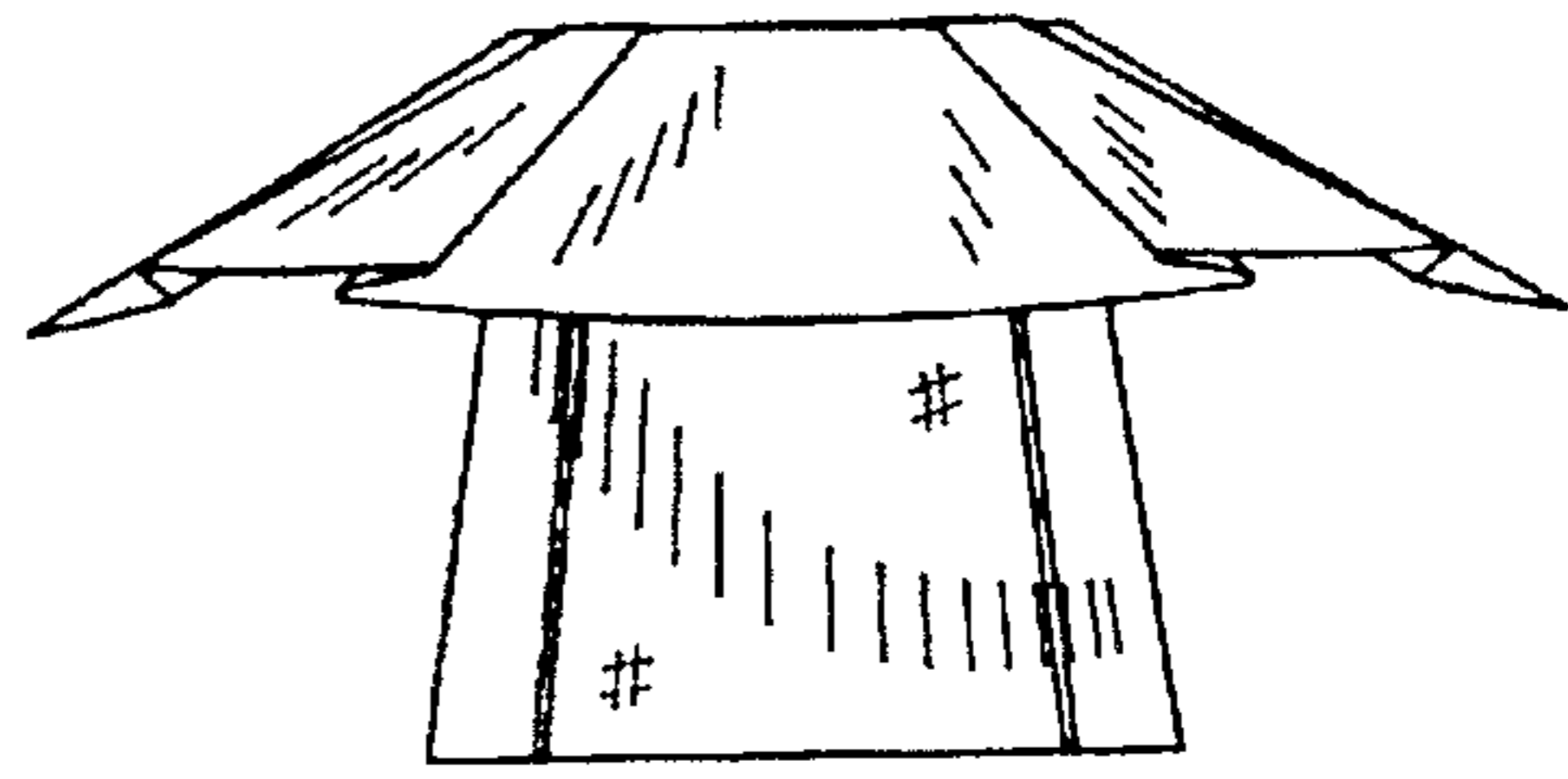

FIG. 28

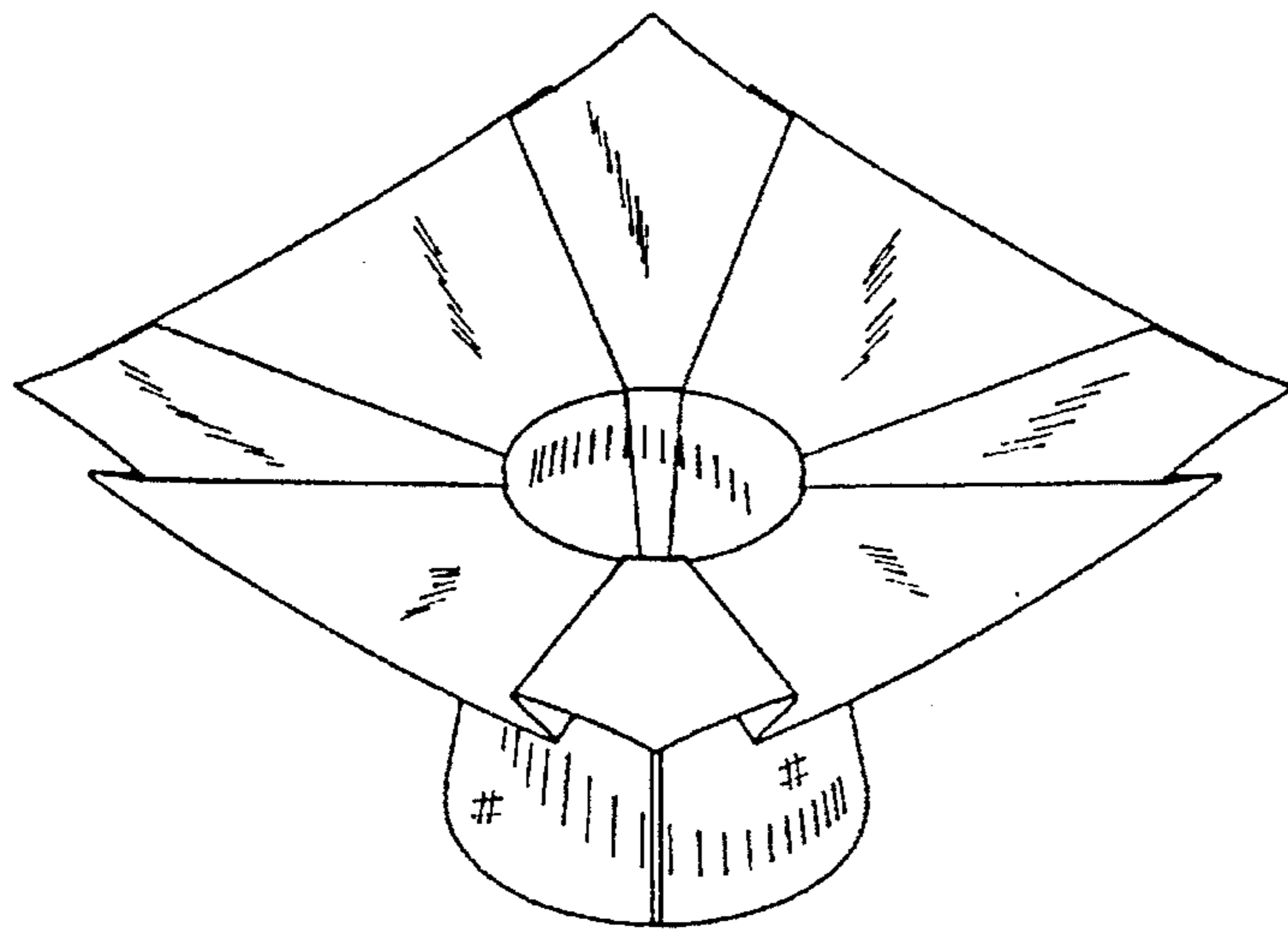

FIG. 29

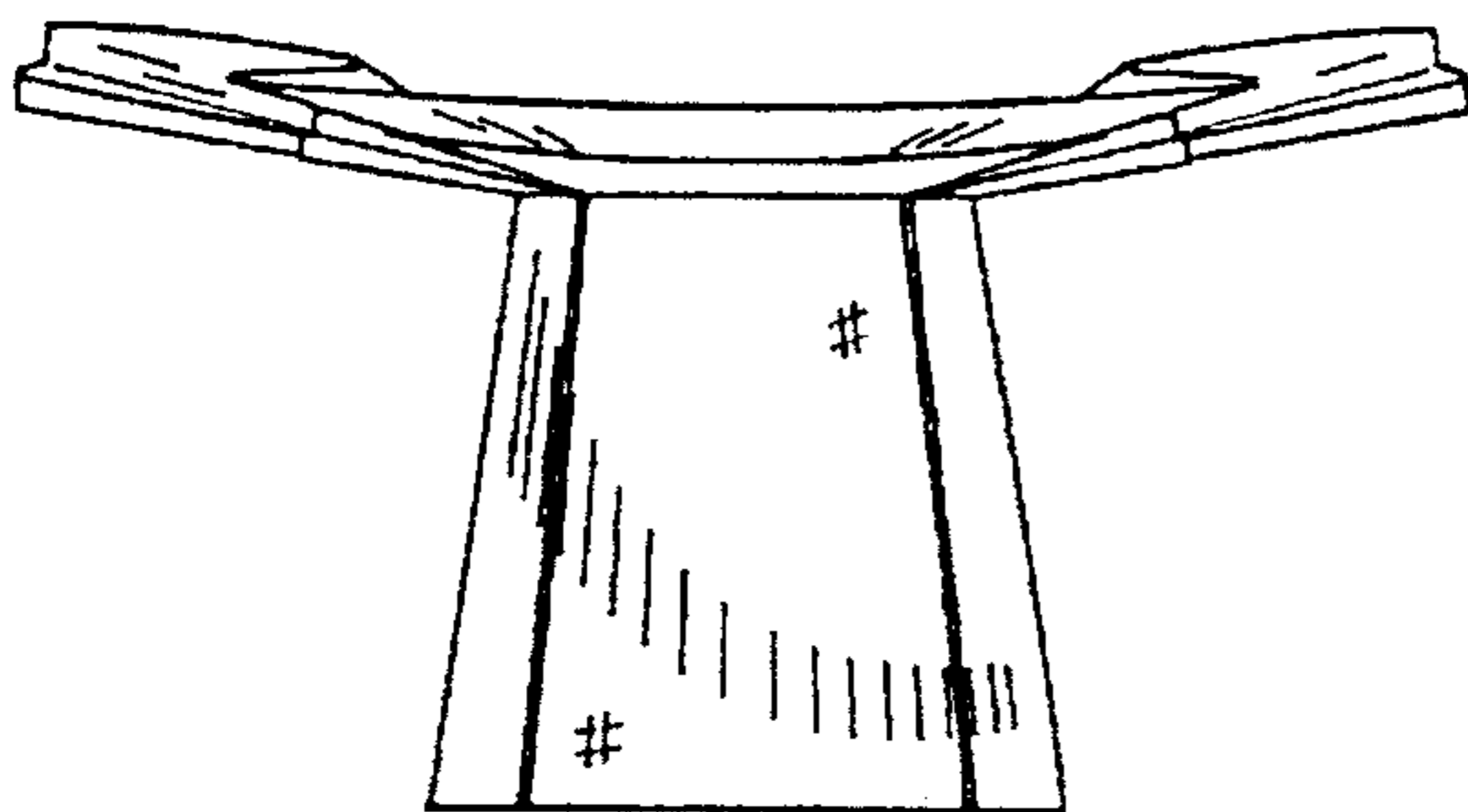

FIG. 30

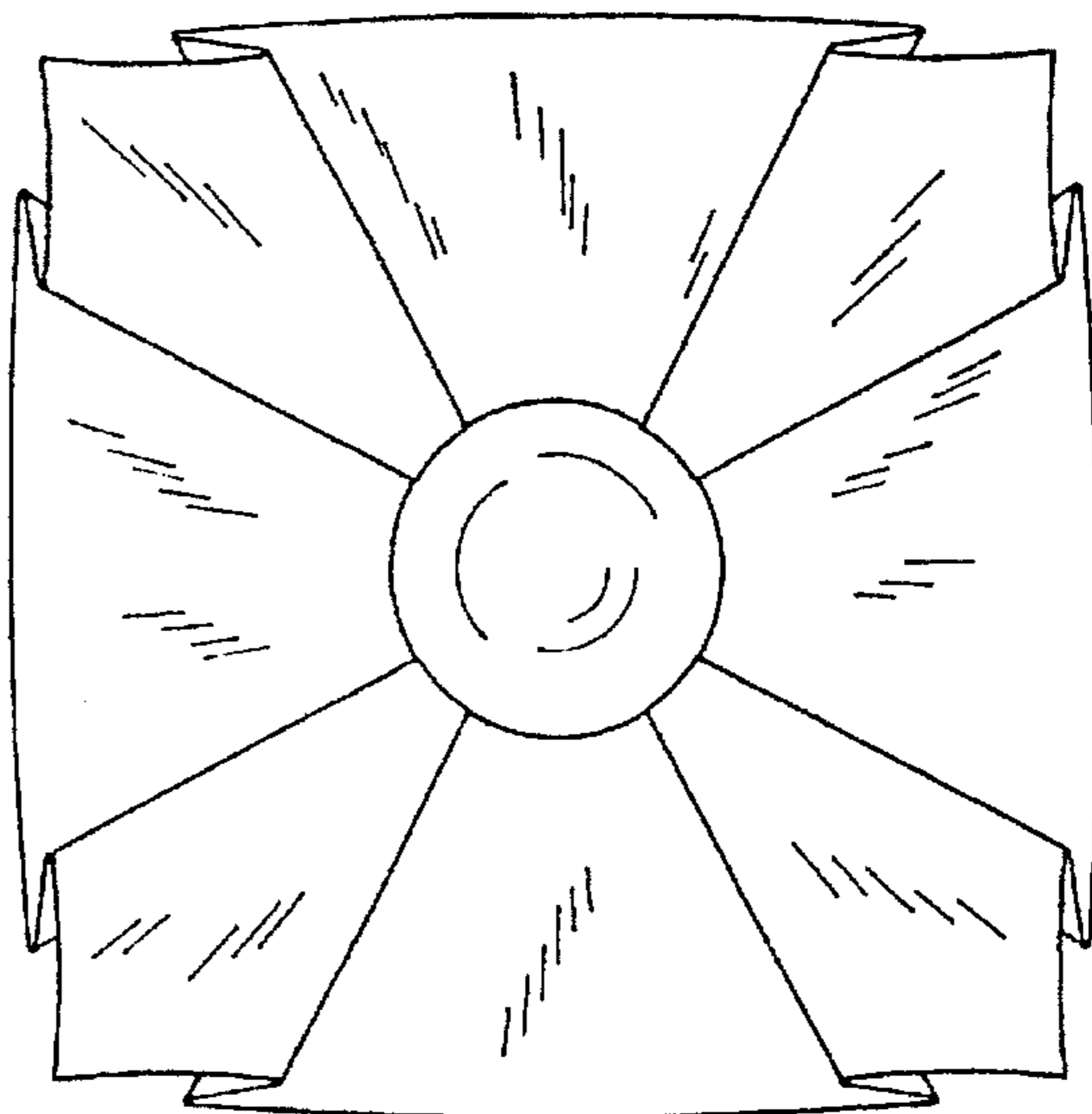

FIG. 31



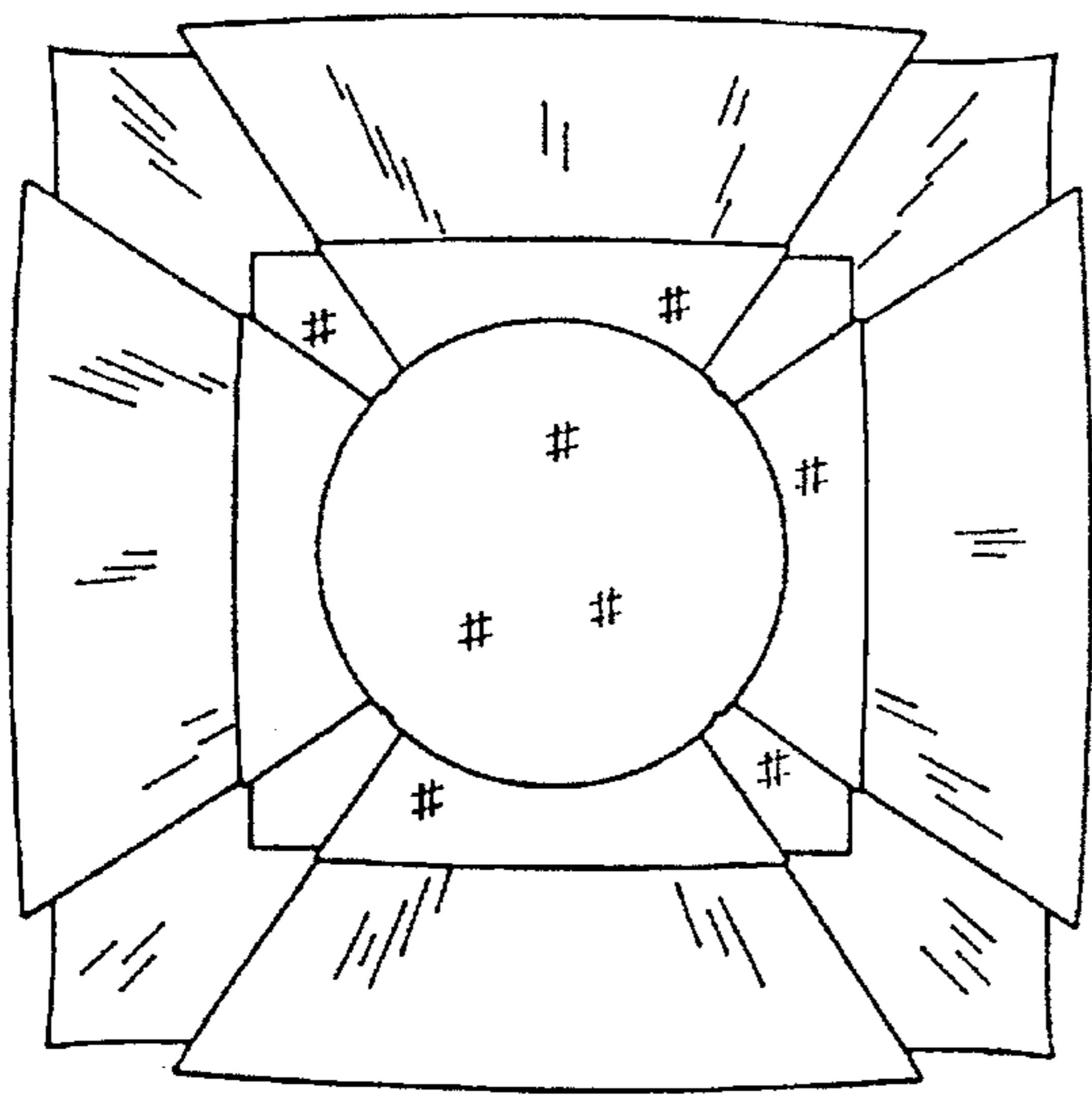

FIG. 32

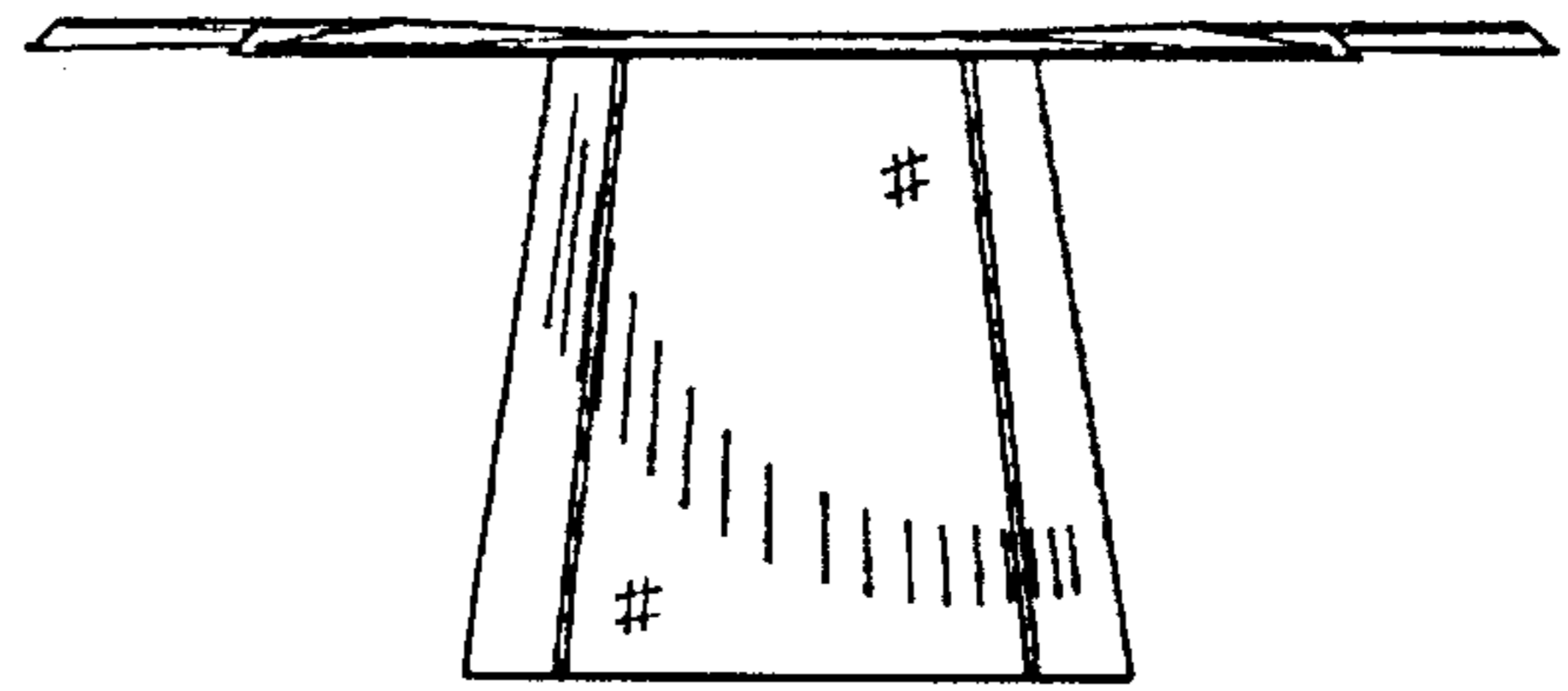

FIG. 33

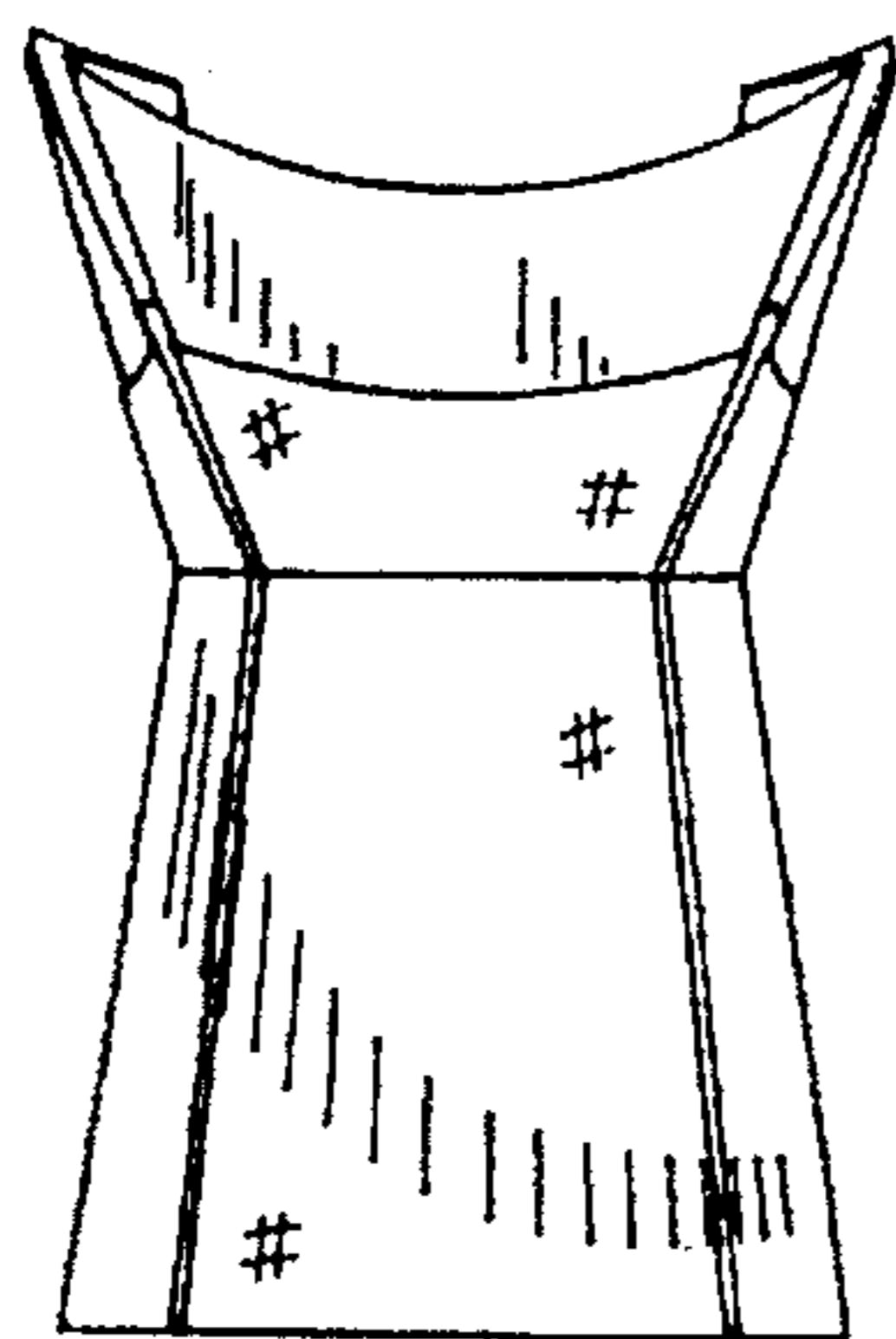

FIG. 34

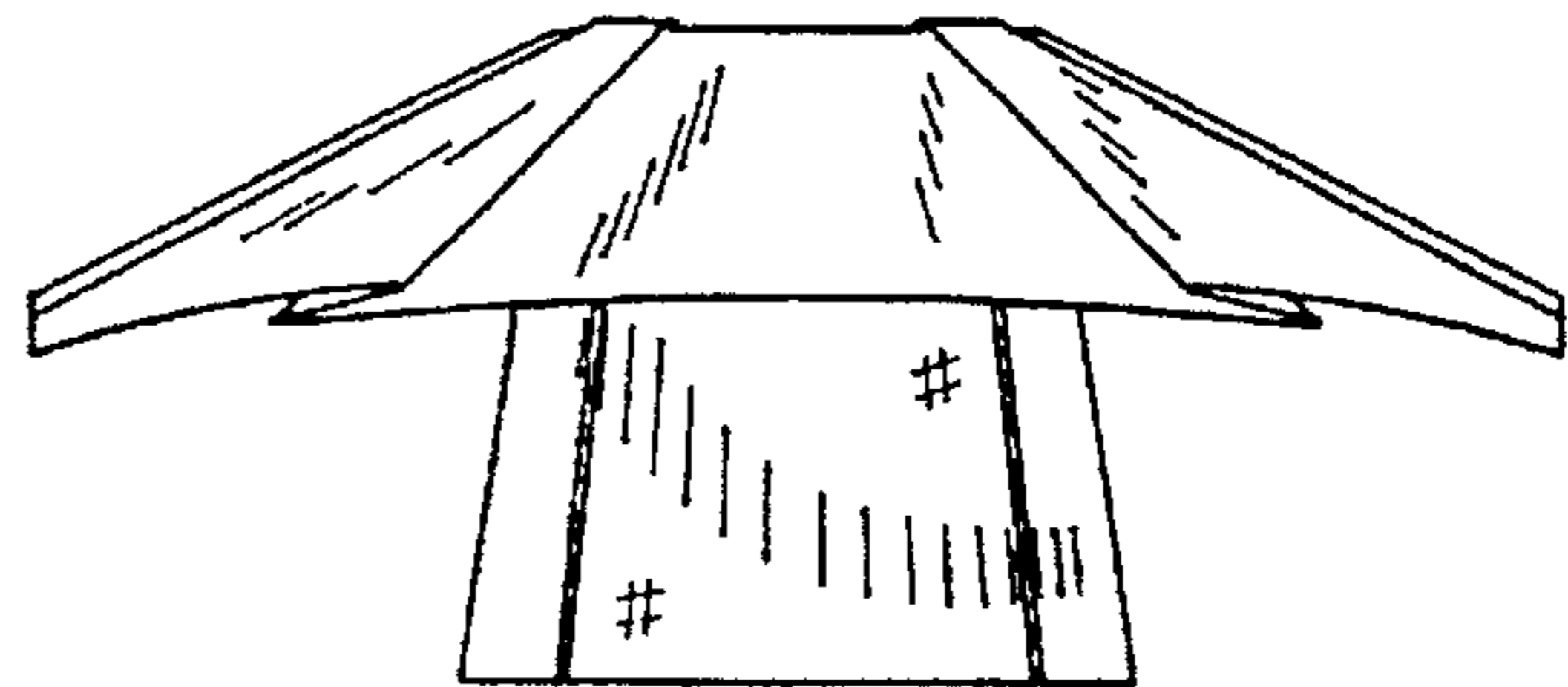

FIG. 35