



US00D383072S

United States Patent [19]

Visage

[11] Patent Number: **Des. 383,072**

[45] Date of Patent: ****Sep. 2, 1997**

[54] **SQUARE WATCH CASE**

[75] Inventor: **Agnes Visage**, Croissy, France

[73] Assignee: **Christian Dior**, Paris, France

[**] Term: **14 Years**

[21] Appl. No.: **28,483**

[22] Filed: **Sep. 16, 1994**

[30] Foreign Application Priority Data

Mar. 16, 1994 [FR] France 941536

[51] LOC (6) CL **10-02**

[52] U.S. Cl. **D10/30; D10/39**

[58] Field of Search D10/1-40, 122-132;
368/280-282, 276-277, 285

[56] References Cited

U.S. PATENT DOCUMENTS

| | | | | |
|------------|---------|---------|-------|---------|
| D. 71,839 | 1/1927 | Klinke | | D11/3 |
| D. 72,369 | 4/1927 | Klinke | | D11/3 |
| D. 73,958 | 11/1927 | Becker | | D10/38 |
| D. 158,099 | 4/1950 | Kaufman | | D10/6 |
| D. 315,530 | 3/1991 | Robert | | D10/126 |

| | | | | |
|------------|---------|------------|-------|-----------|
| D. 351,799 | 10/1994 | Bulgari | | D10/39 |
| 1,936,290 | 11/1933 | Ditisheim | | D10/128 X |
| 2,226,138 | 12/1940 | Prestinari | | 368/281 |
| 4,218,873 | 8/1980 | Lang | | 368/281 |

OTHER PUBLICATIONS

European Jeweler—Aug. 1977—p. 54—Watch at Bottom Right.

Primary Examiner—Nelson C. Holtje
Attorney, Agent, or Firm—Amster, Rothstein & Ebenstein

[57] CLAIM

The ornamental design for a square watch case, as shown and described.

DESCRIPTION

FIG. 1 is a top plan view of a watch case, showing my new design;
FIG. 2 is an inverted bottom plan view thereof;
FIG. 3 is an inverted top elevational view thereof;
FIG. 4 is an inverted bottom elevational view thereof;
FIG. 5 is a right-side elevational view thereof;
FIG. 6 is a left-side elevational view thereof; and,
FIG. 7 is a top right-side perspective view thereof.

1 Claim, 3 Drawing Sheets

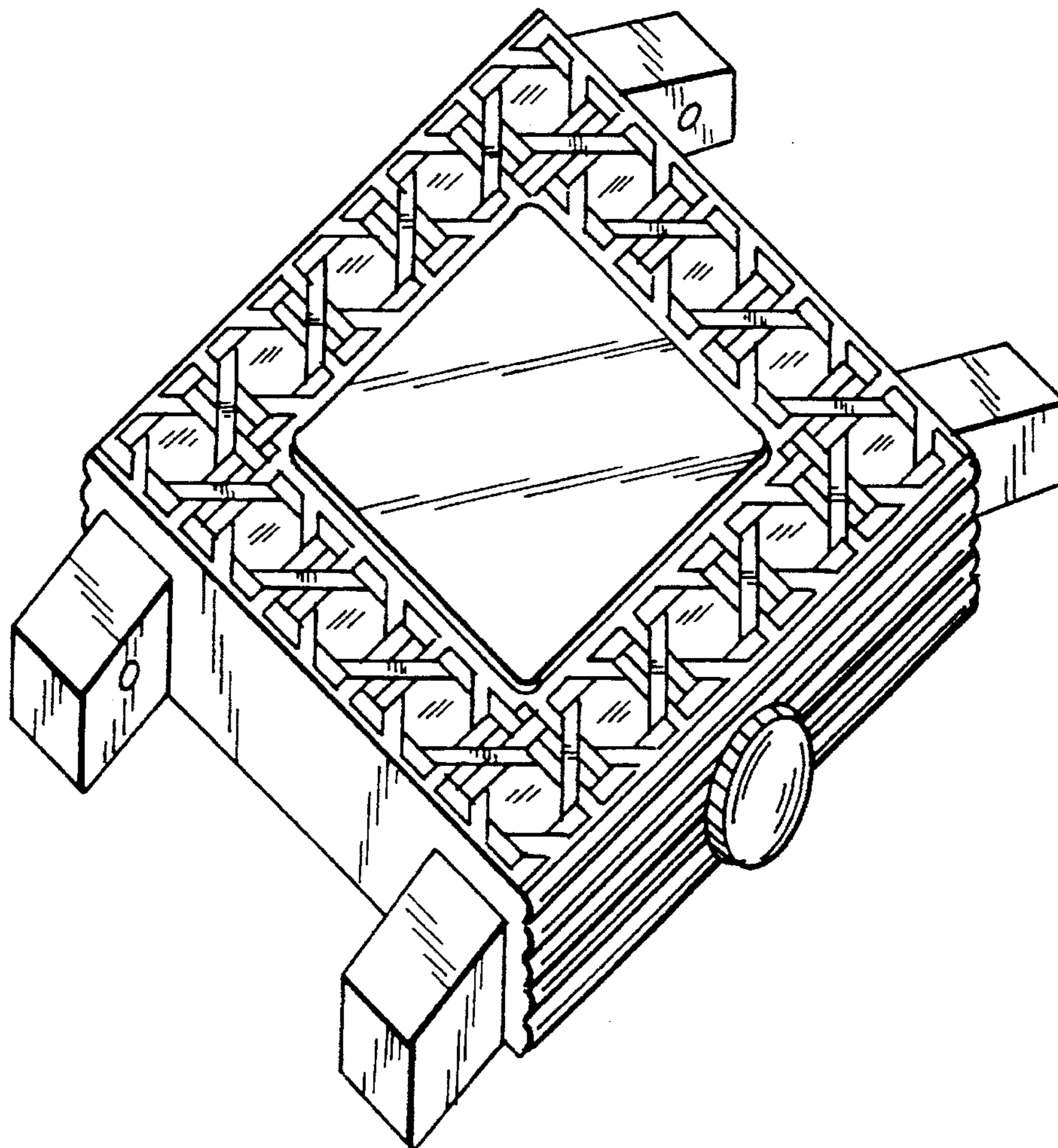

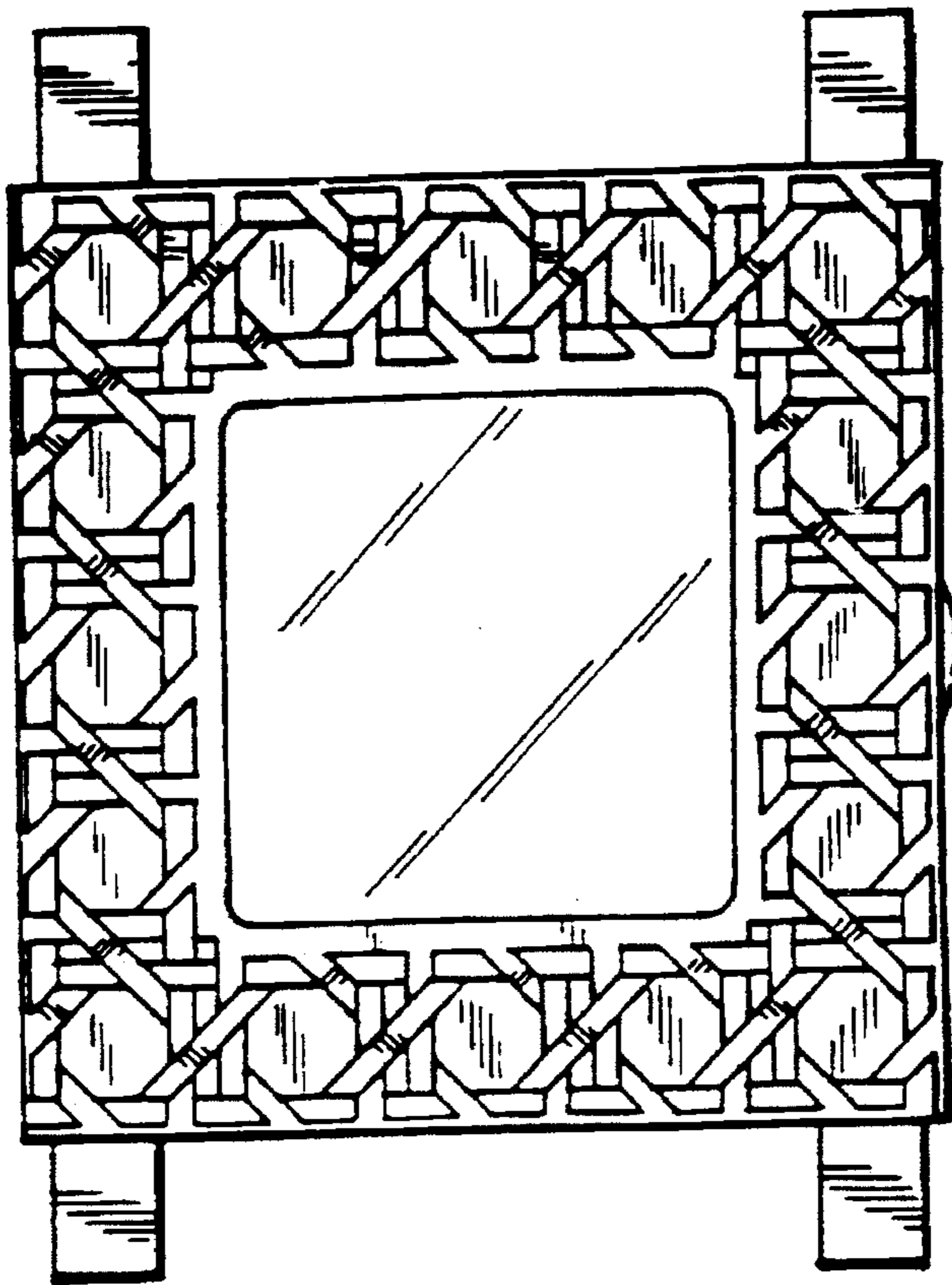

FIG. 1

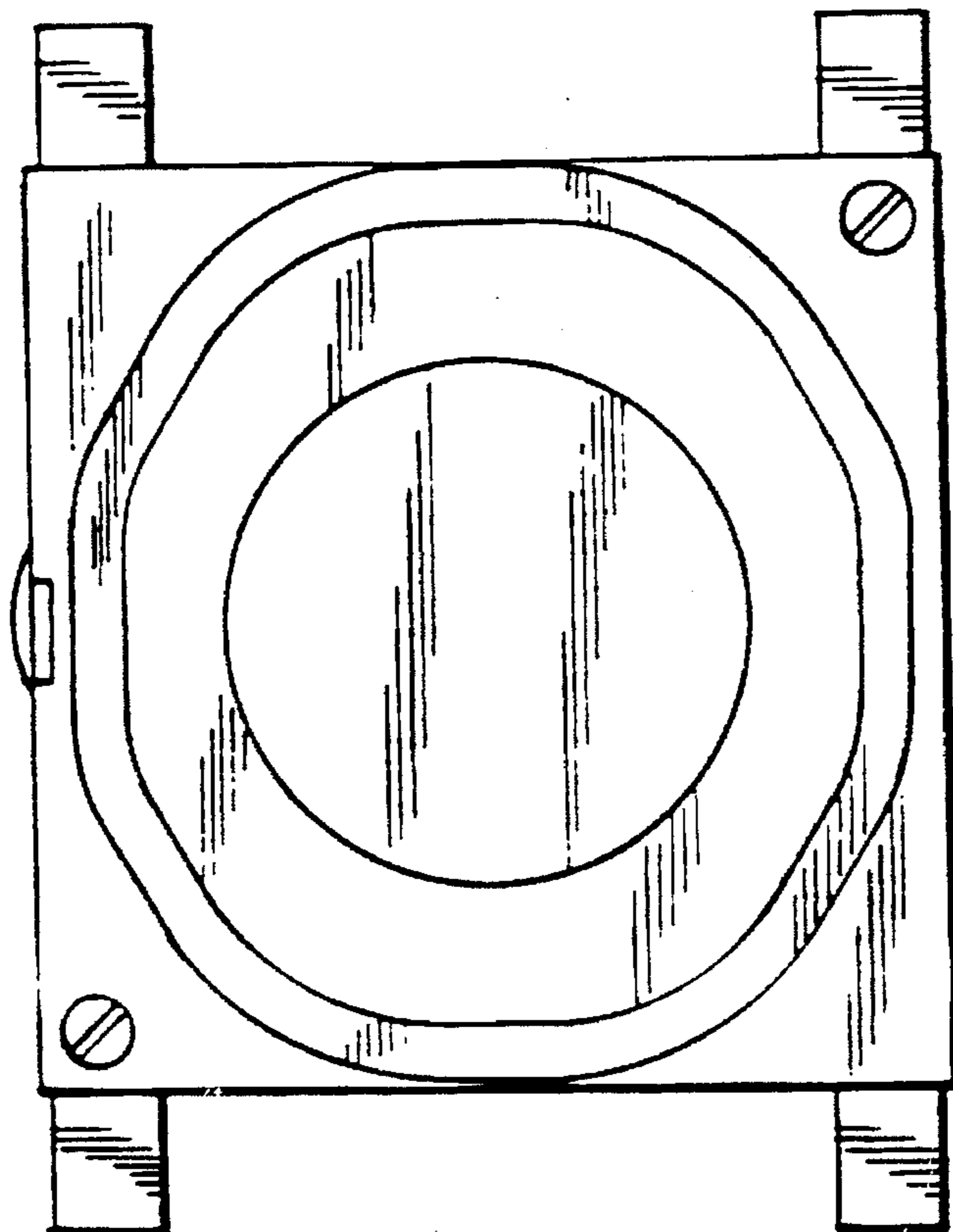

FIG. 2

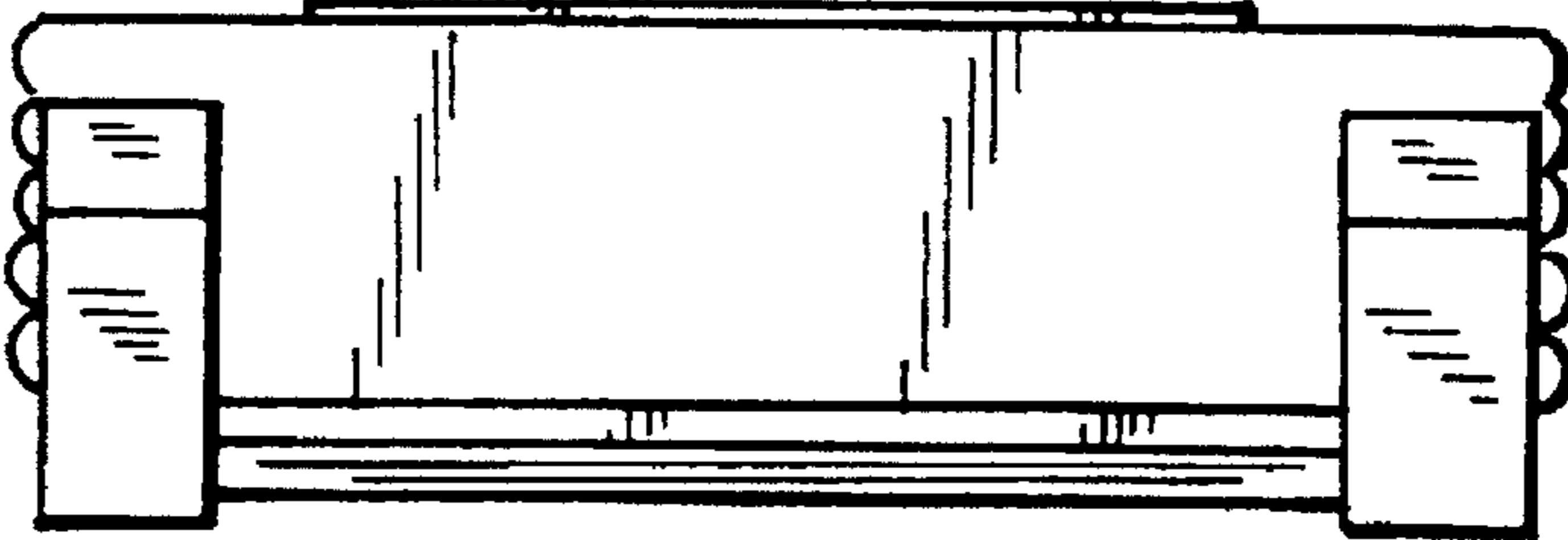

FIG. 3

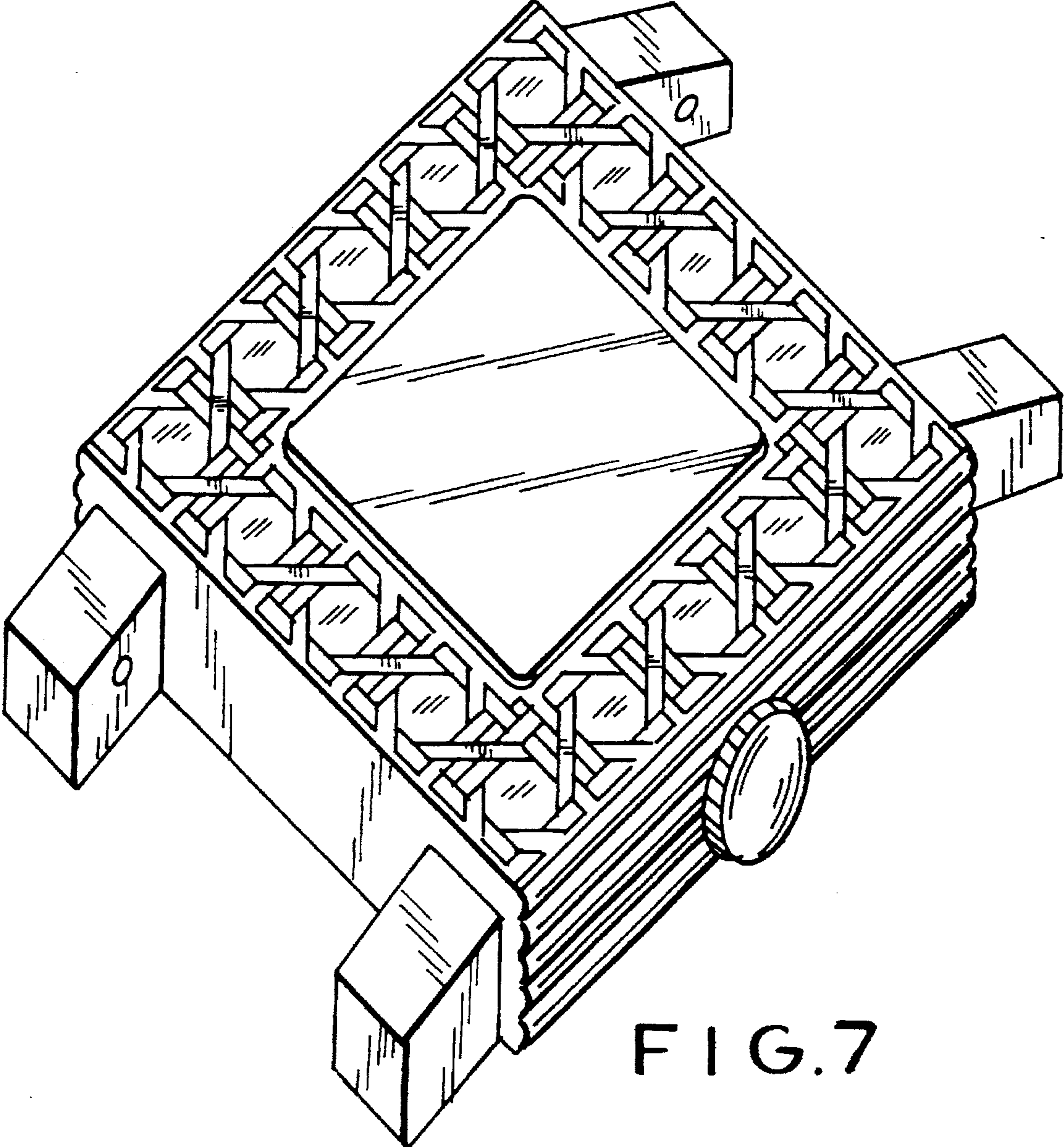

FIG. 7

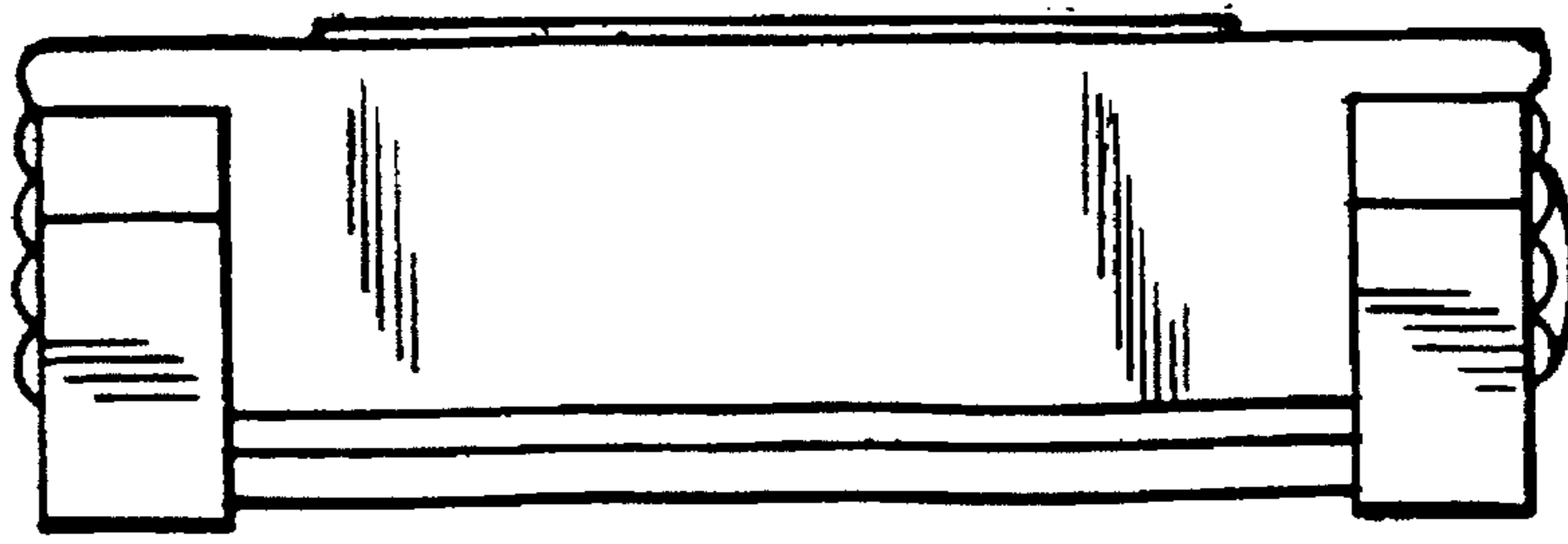

FIG. 4

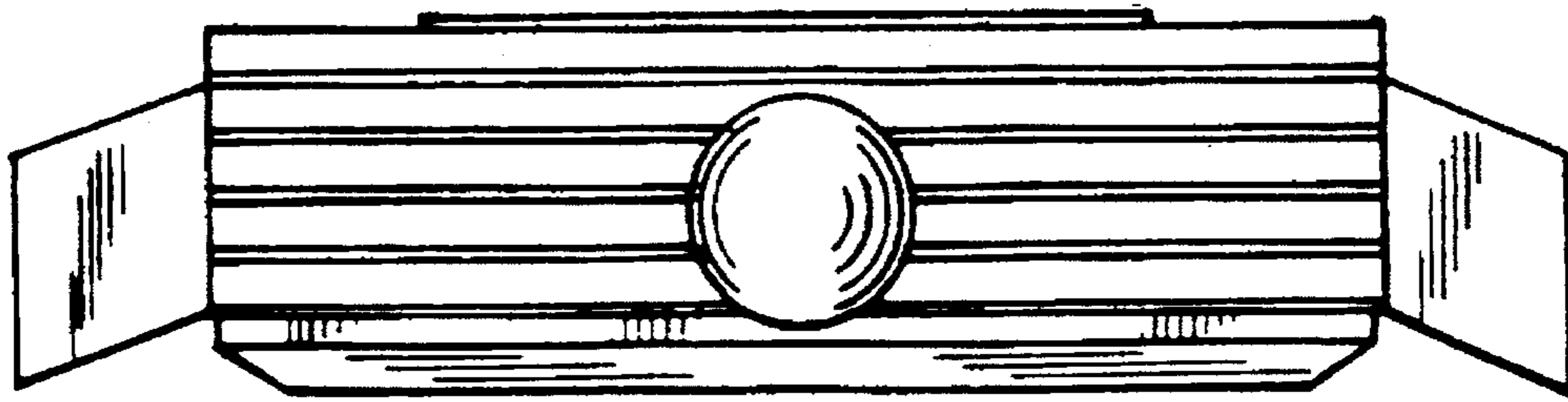

FIG. 5

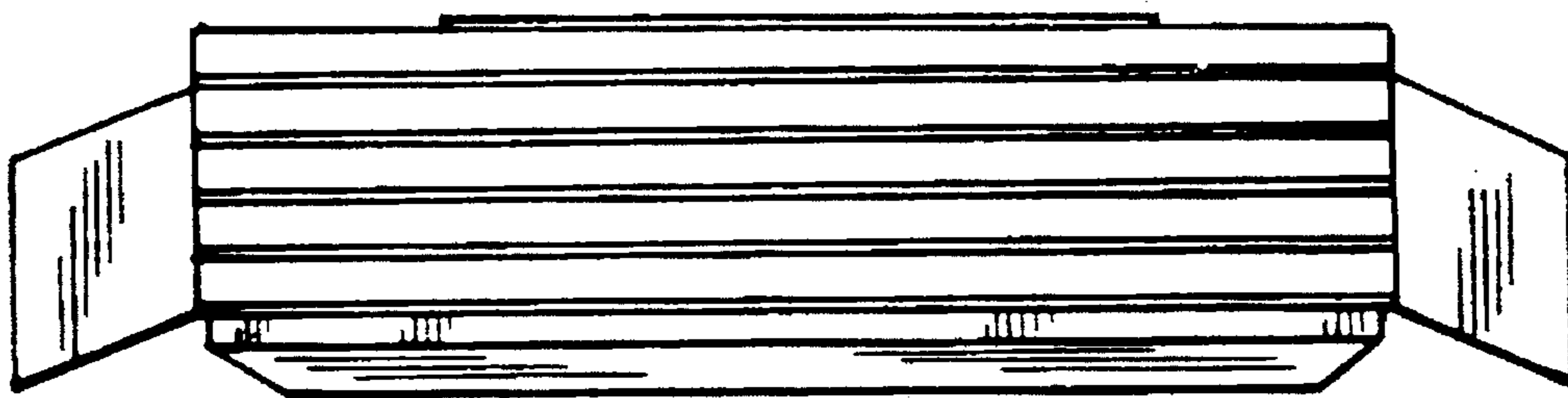

FIG. 6