



US00D382974S

United States Patent [19]

[11] Patent Number: **Des. 382,974**

Lahm et al.

[45] Date of Patent: ****Aug. 26, 1997**

[54] **THERMOFORM DISH**

[75] Inventors: **William Lahm**, Sumter, S.C.; **Timothy A. Stevens**, Madison, N.J.

[73] Assignee: **Becton, Dickinson and Company**, Franklin Lakes, N.J.

[**] Term: **14 Years**

4,968,625 11/1990 Smith et al. 435/305.3
 5,026,649 6/1991 Lyman et al. 435/284
 5,139,951 8/1992 Butz et al. 435/284
 5,215,920 6/1993 Lyman et al. 435/284
 5,272,083 12/1993 Butz et al. 435/240.241
 5,358,871 10/1994 Stevens et al. 435/284
 5,366,893 11/1994 Stevens et al. 435/305.3 X
 5,462,874 10/1995 Wolf et al. 435/305.3 X
 5,468,638 11/1995 Barker et al. 435/305.1 X

[21] Appl. No.: **39,749**

[22] Filed: **Jun. 5, 1995**

[51] LOC (6) Cl. **24-02**

[52] U.S. Cl. **D24/224; D24/216; D24/227**

[58] Field of Search D24/224, 227, D24/226, 229; D9/341, 345, 346; 422/100, 102; 435/305.1, 305.4, 286.6, 286.2, 284; 220/507, 517, 518; 206/561, 565, 564, 557

FOREIGN PATENT DOCUMENTS

0 401 660A1 12/1990 European Pat. Off. .

Primary Examiner—Louis S. Zarfaz
Assistant Examiner—Ian Simmons
Attorney, Agent, or Firm—Nanette S. Thomas

[56] References Cited

U.S. PATENT DOCUMENTS

D. 288,234 2/1987 Blatherwick et al. D24/230
 D. 360,698 7/1995 Stevens et al. D24/224
 3,197,058 7/1965 Hale D9/341 X
 4,407,943 10/1983 Cole et al. 435/7
 4,495,289 1/1985 Lyman et al. D24/226 X
 4,686,190 8/1987 Cramer et al. 435/291
 4,871,674 10/1989 Matsui et al. 435/284

[57] CLAIM

The ornamental design of thermoform dish, as shown.

DESCRIPTION

FIG. 1 is a top and front perspective view of the thermoform dish;
 FIG. 2 is a top plan view thereof;
 FIG. 3 is a front elevational view thereof;
 FIG. 4 is a side elevational view thereof; and,
 FIG. 5 is a back elevational view thereof;
 FIG. 6 is a bottom plan view thereof; and,
 FIG. 7 is an exploded view thereof.

1 Claim, 6 Drawing Sheets

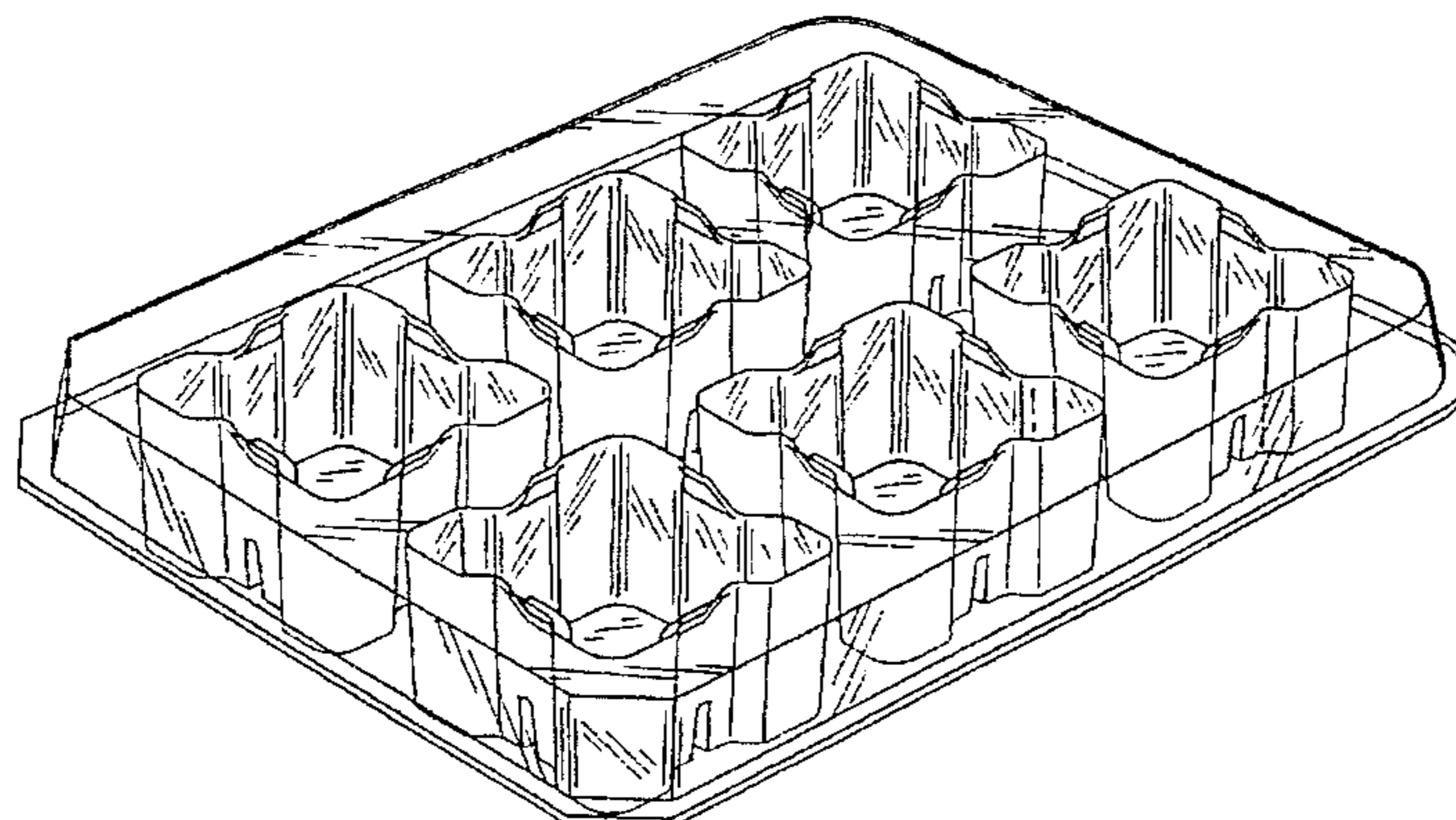
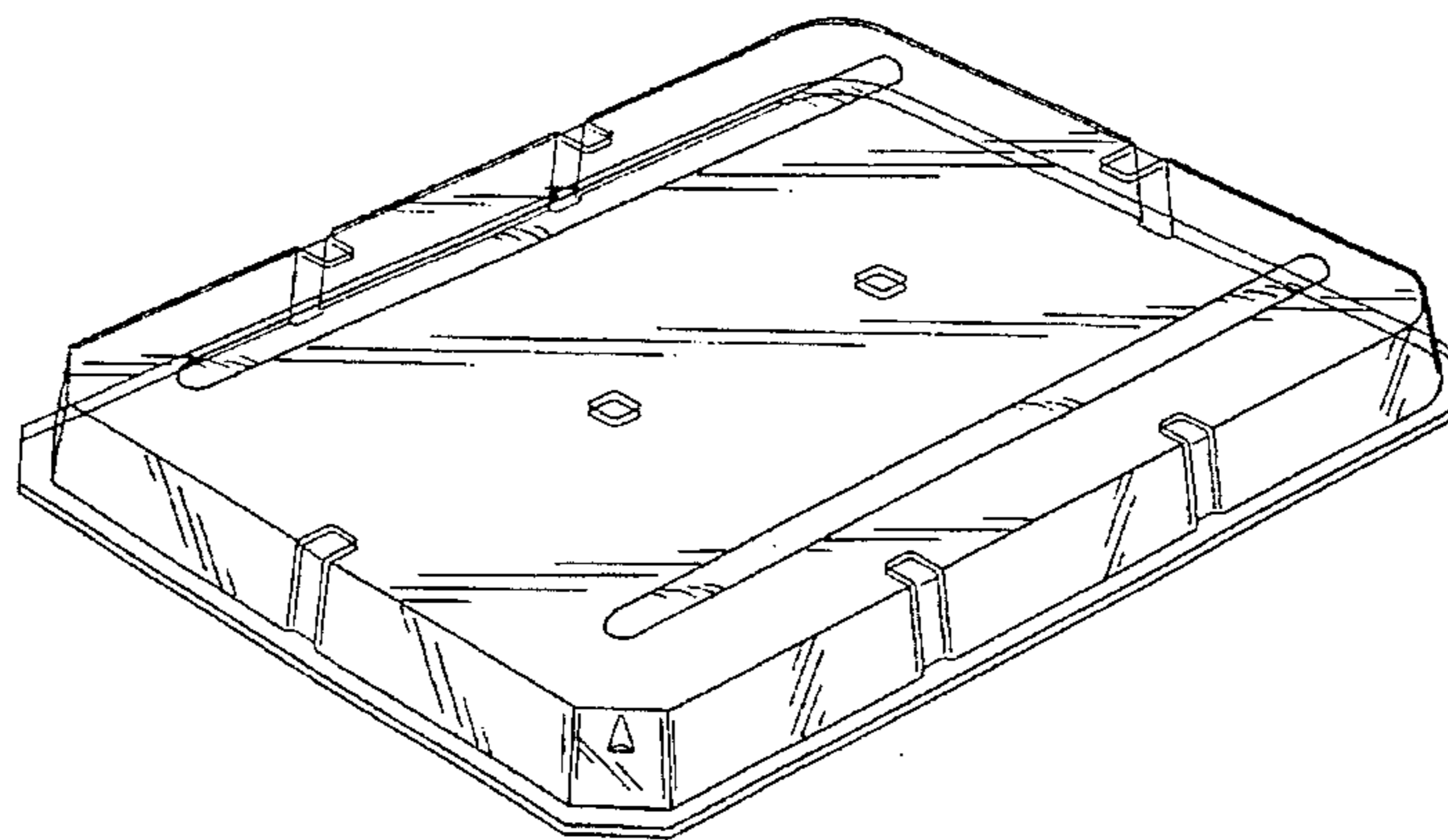

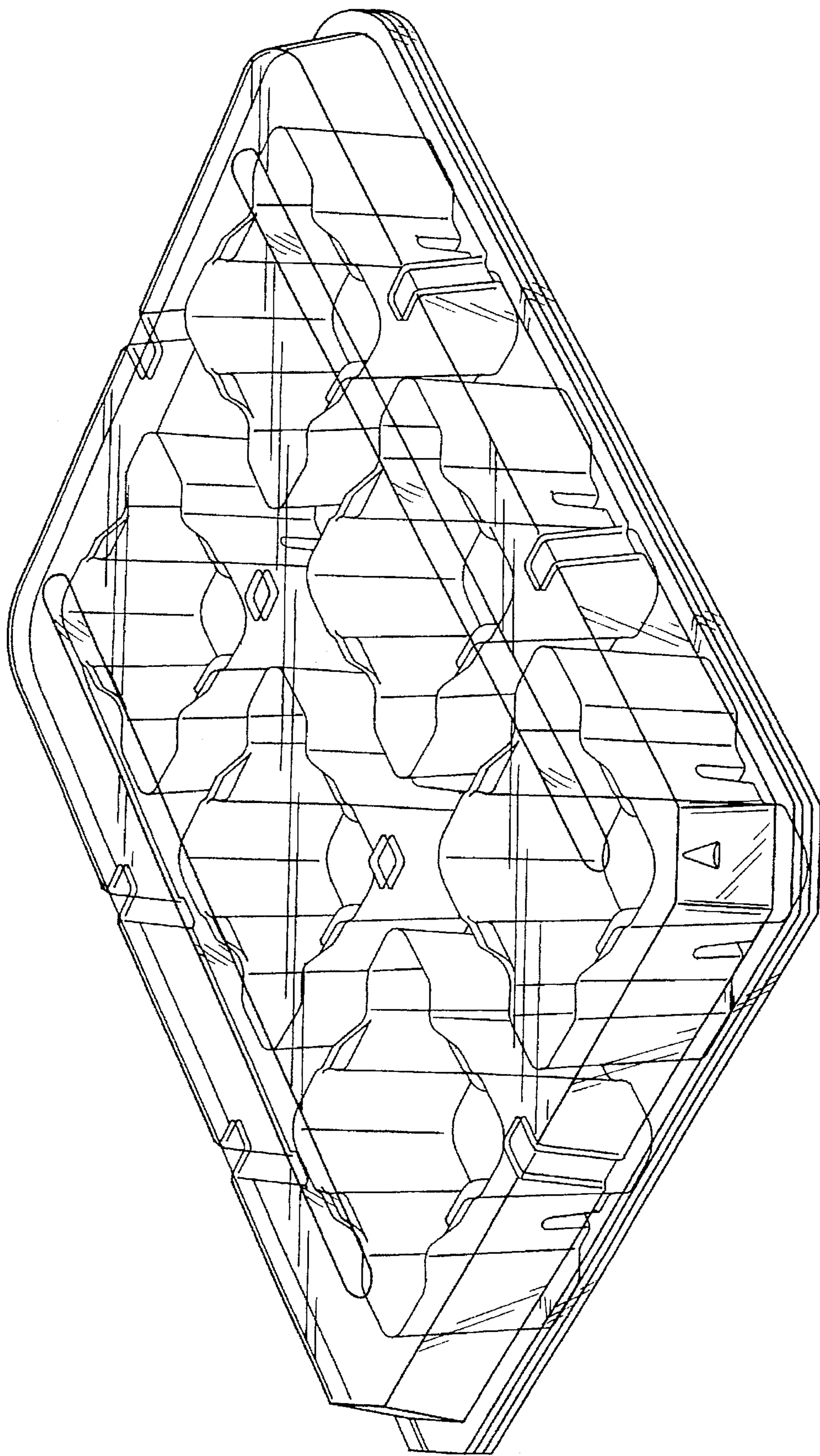

FIG-1

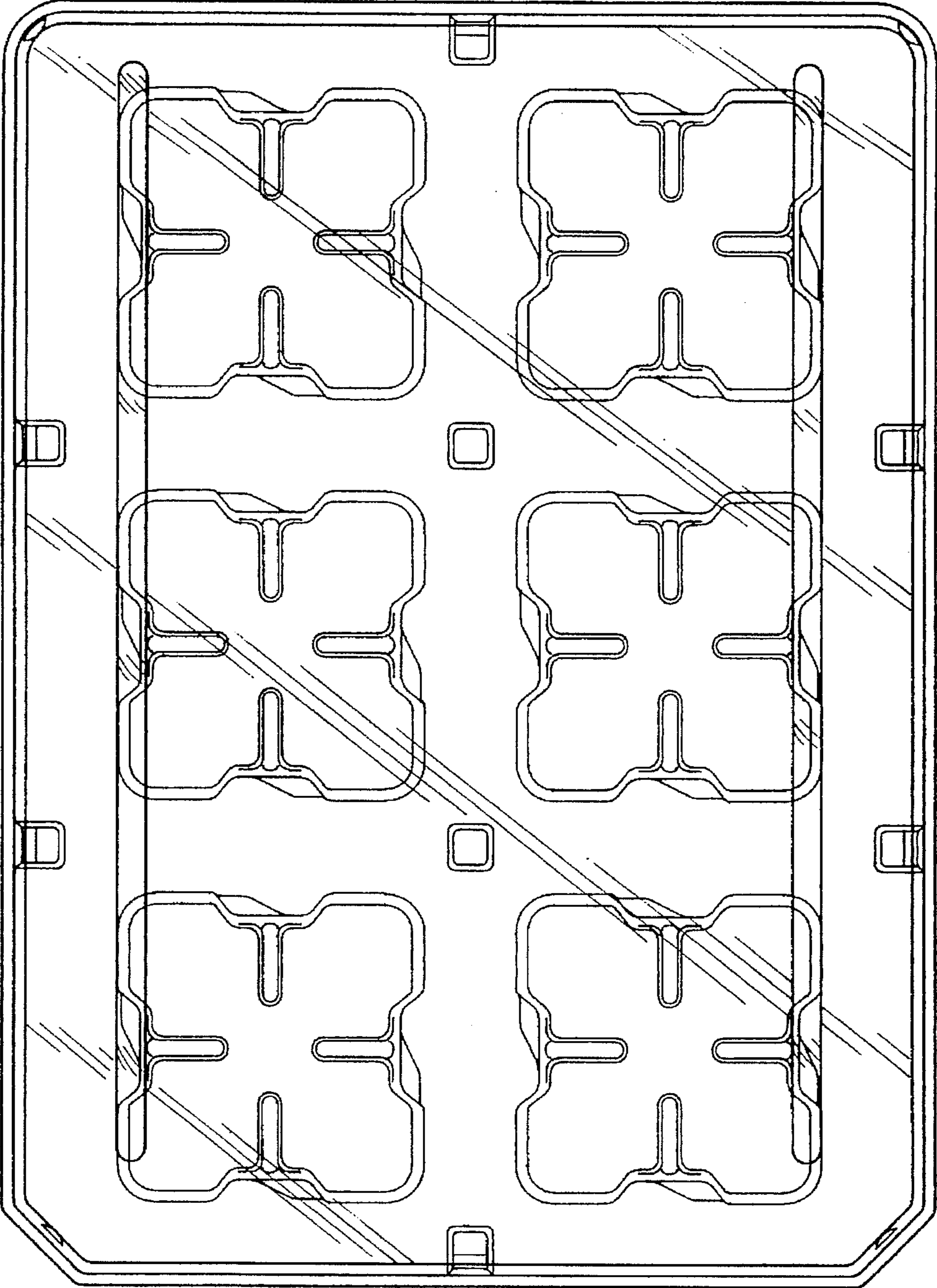

FIG-2

FIG-3

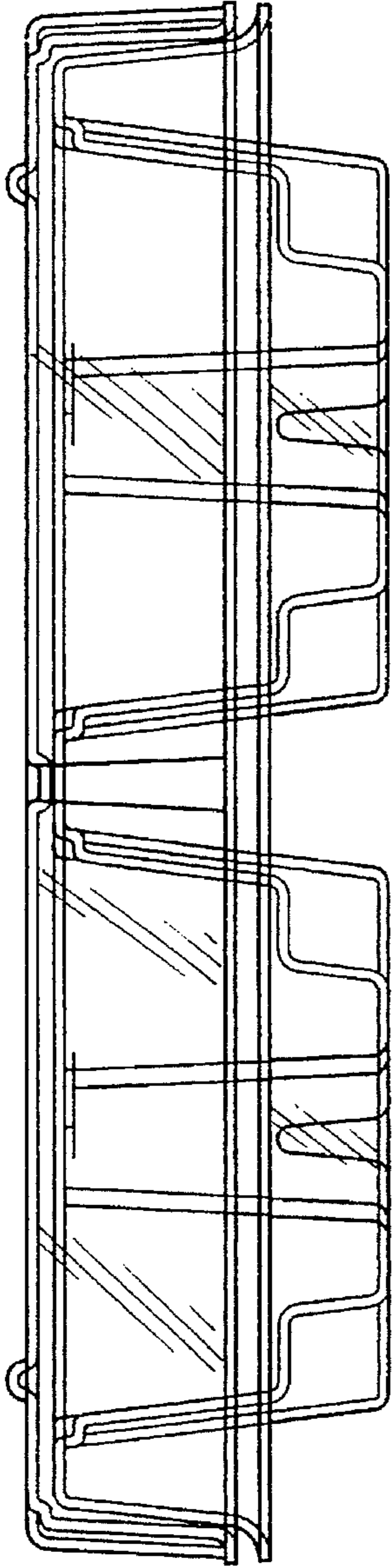

FIG-4

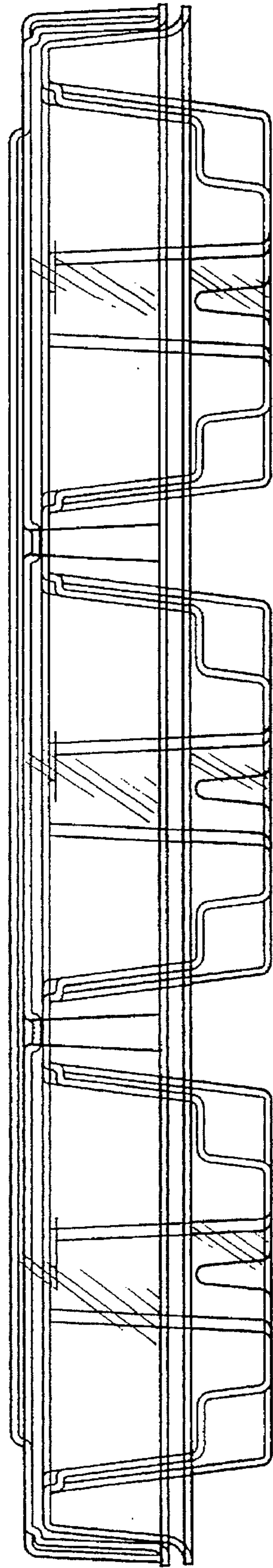
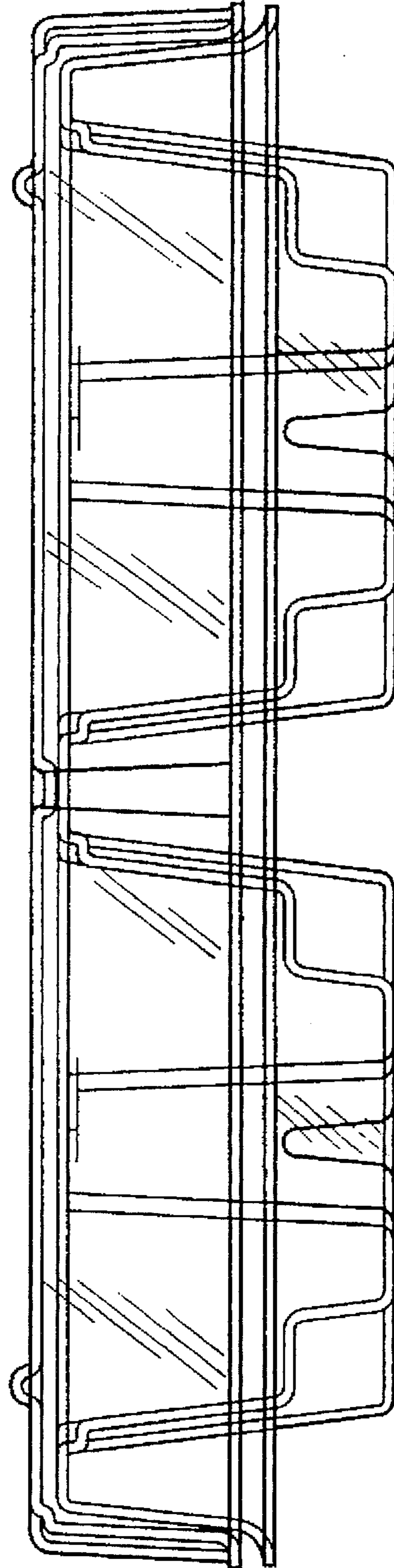

FIG-5



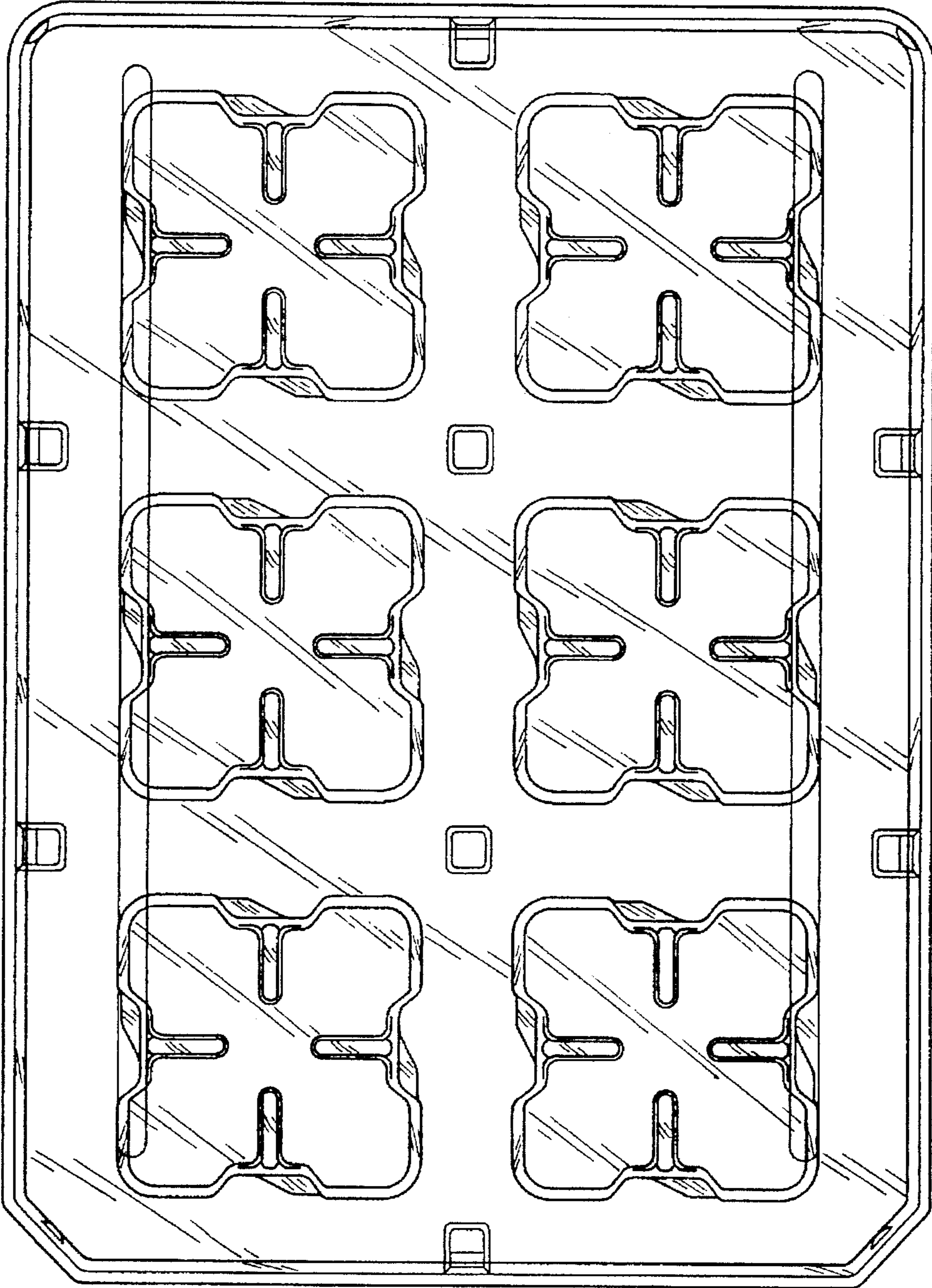

FIG-6

FIG-7

