



US00D382887S

United States Patent [19]

[11] Patent Number: Des. 382,887

Hollar et al.

[45] Date of Patent: **Aug. 26, 1997

[54] BACK DRILLING THREADED BIT

4,730,682 3/1988 Ditzig .

5,025,875 6/1991 Witt .

[75] Inventors: Charles D. Hollar, Roanoke; Stuart A. Connell, Buchanan, both of Va.

5,145,017 9/1992 Holster et al. 175/393 X

5,366,032 11/1994 Kay 175/393

[73] Assignee: Ingersoll-Rand Company, Woodcliff Lake, N.J.

Primary Examiner—Antoine Duval Davis

Attorney, Agent, or Firm—John J. Selko

[**] Term: 14 Years

[57] CLAIM

[21] Appl. No.: 55,215

The ornamental design for a back drilling threaded bit, as shown and described.

[22] Filed: May 31, 1996

DESCRIPTION

[51] LOC (6) Cl. 15-09

FIG. 1 is a perspective view showing the design from the bottom, front and one side;

[52] U.S. Cl. D15/139

FIG. 2 is a front view thereof;

[58] Field of Search D15/138, 139;

FIG. 3 is a top view thereof;

175/21, 393, 371, 400, 403, 418, 424, 431,

FIG. 4 is a bottom view thereof;

340; 408/204, 420, 703

FIG. 5 is a back view thereof; and,

[56] References Cited

FIG. 6 is a left side view thereof, the right side being a mirror image of the left side.

U.S. PATENT DOCUMENTS

D. 359,968 7/1995 Ekblad et al. D15/139

1 Claim, 5 Drawing Sheets

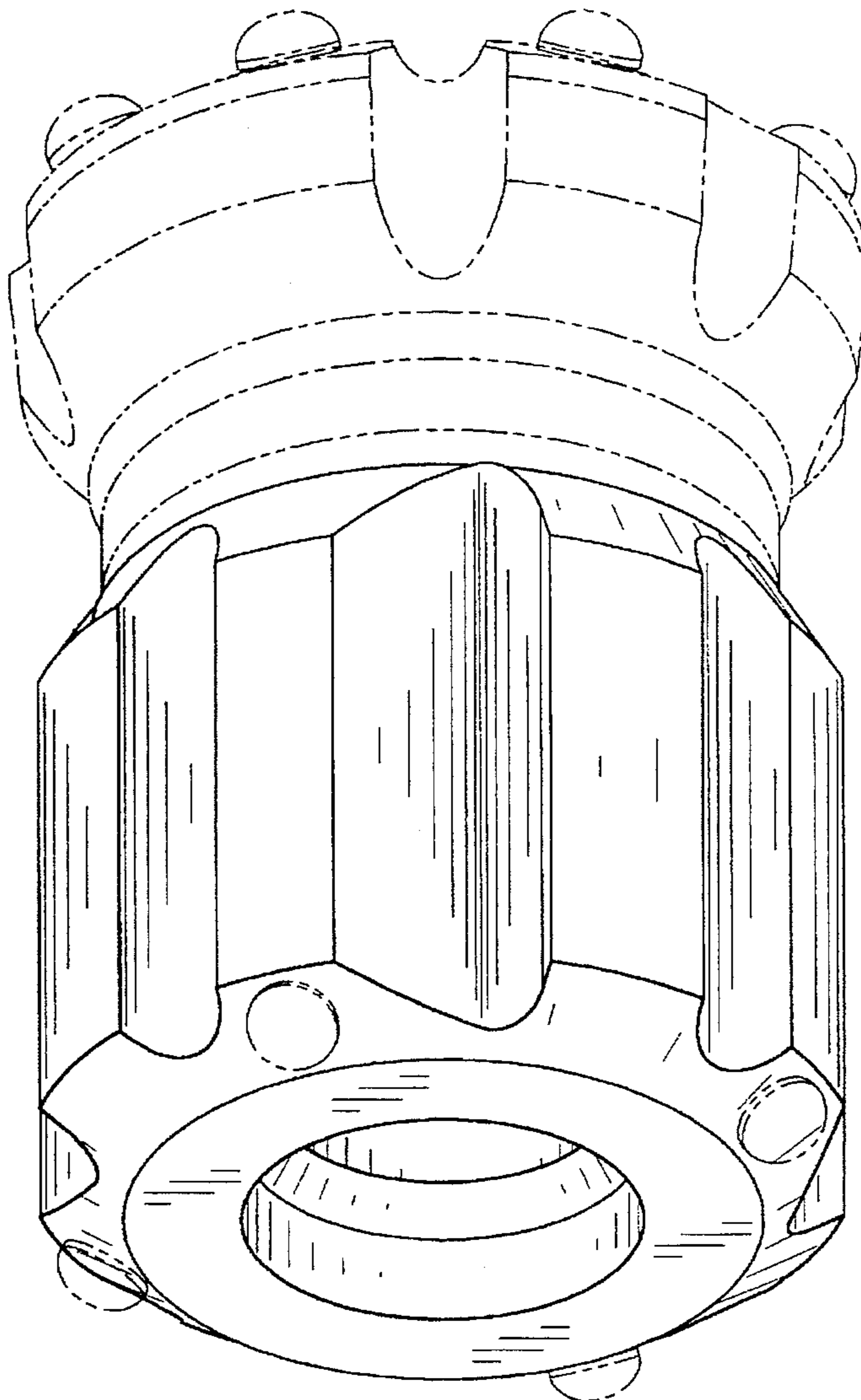

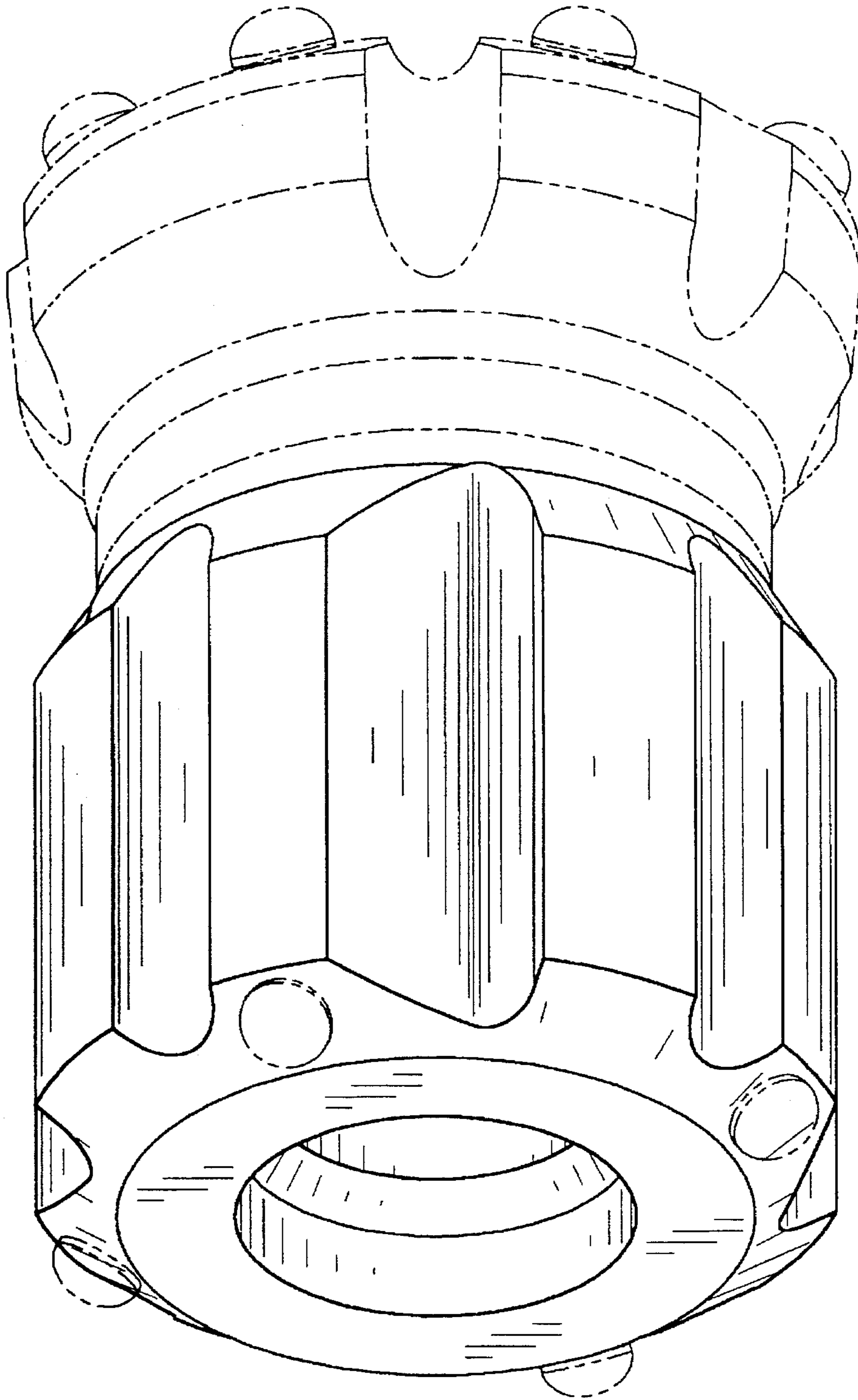

FIG. 1

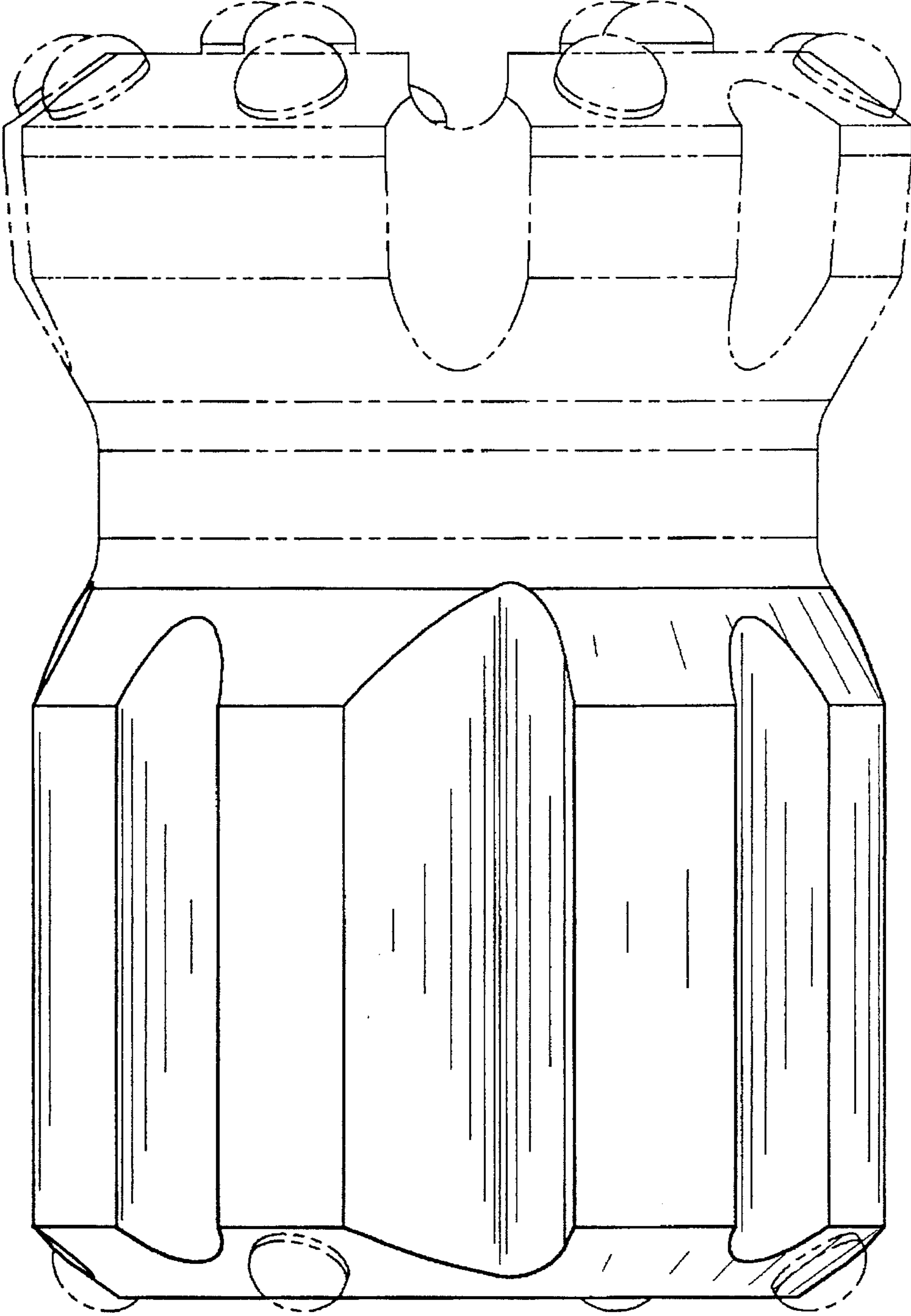

FIG. 2

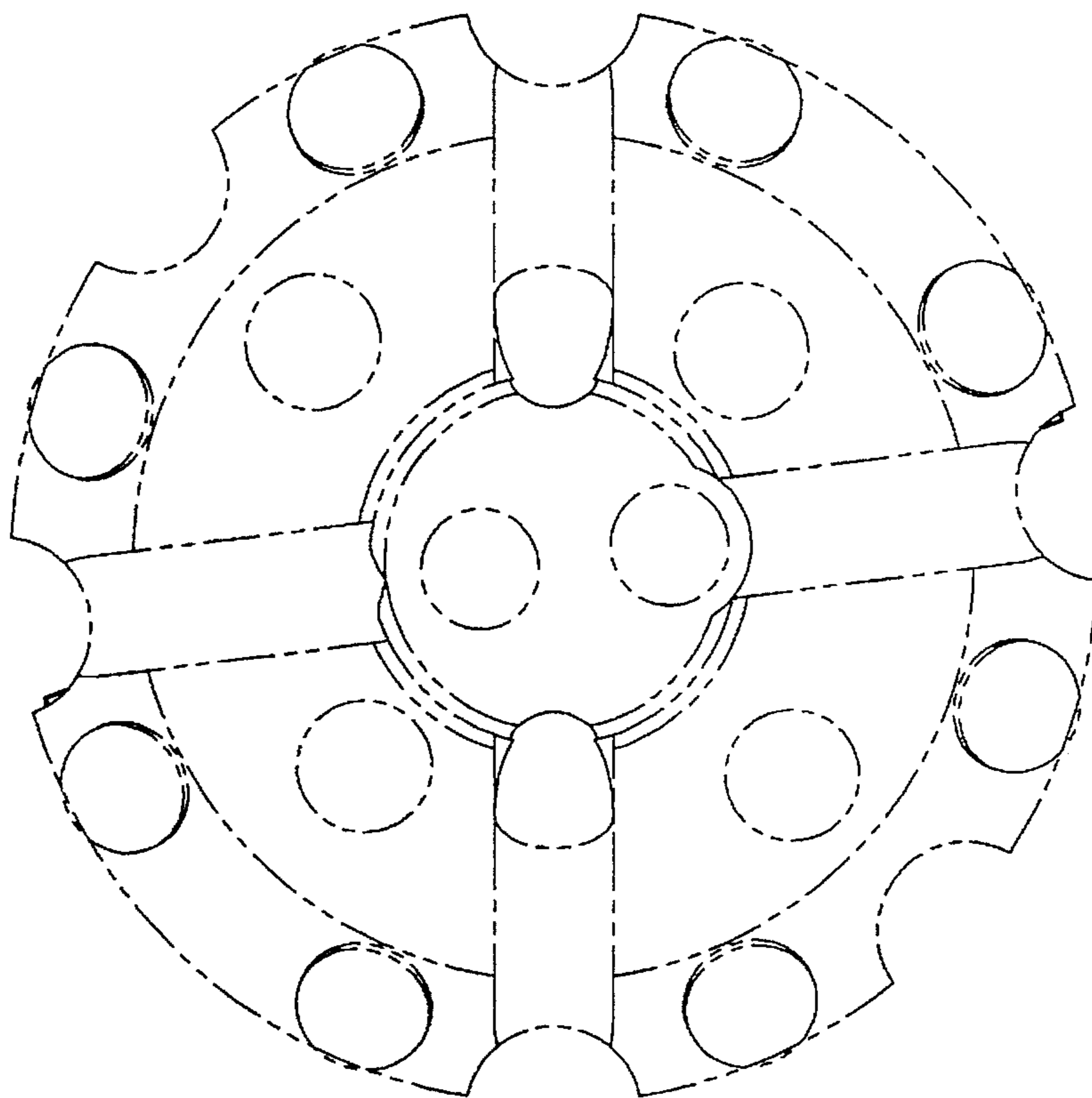

FIG. 3

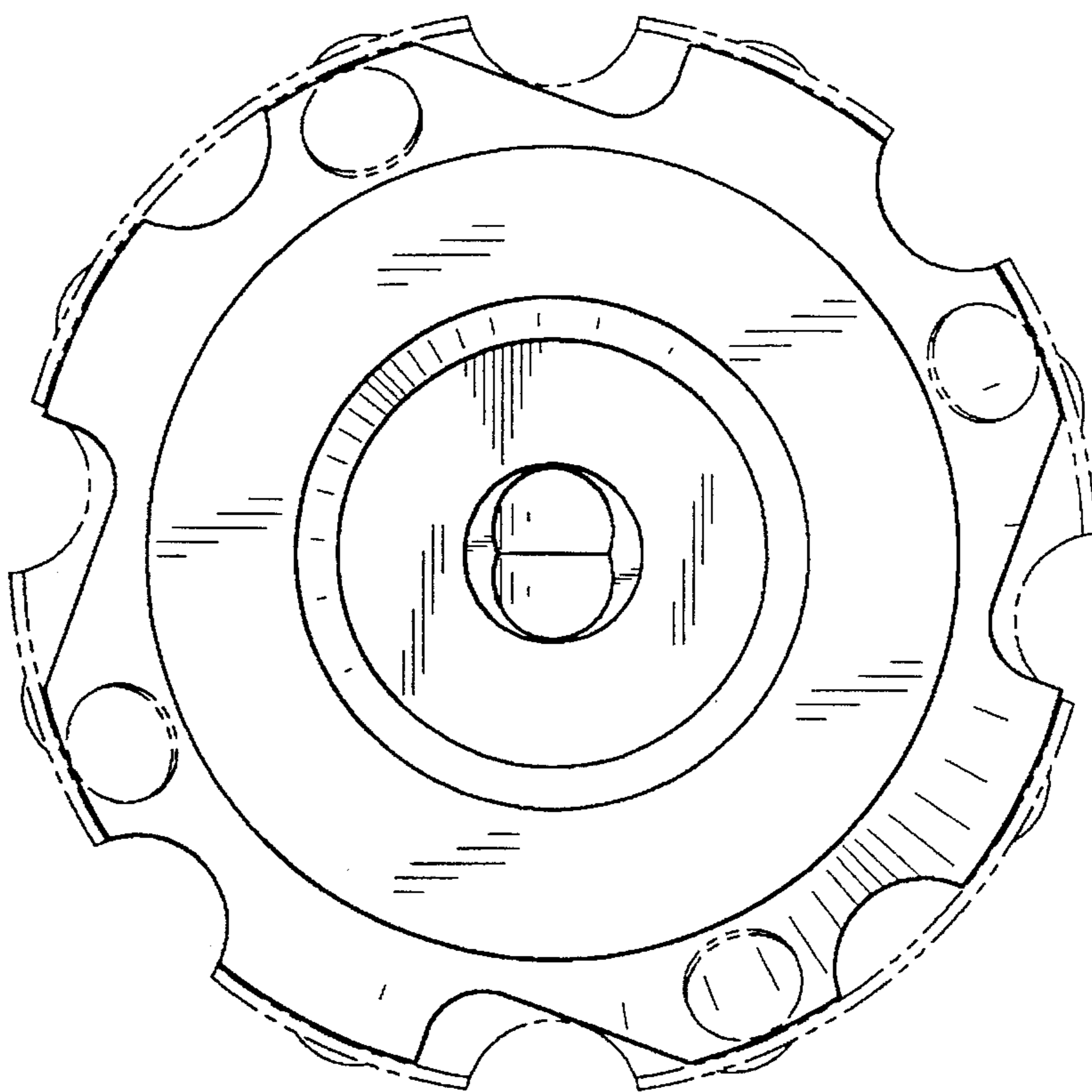

FIG. 4

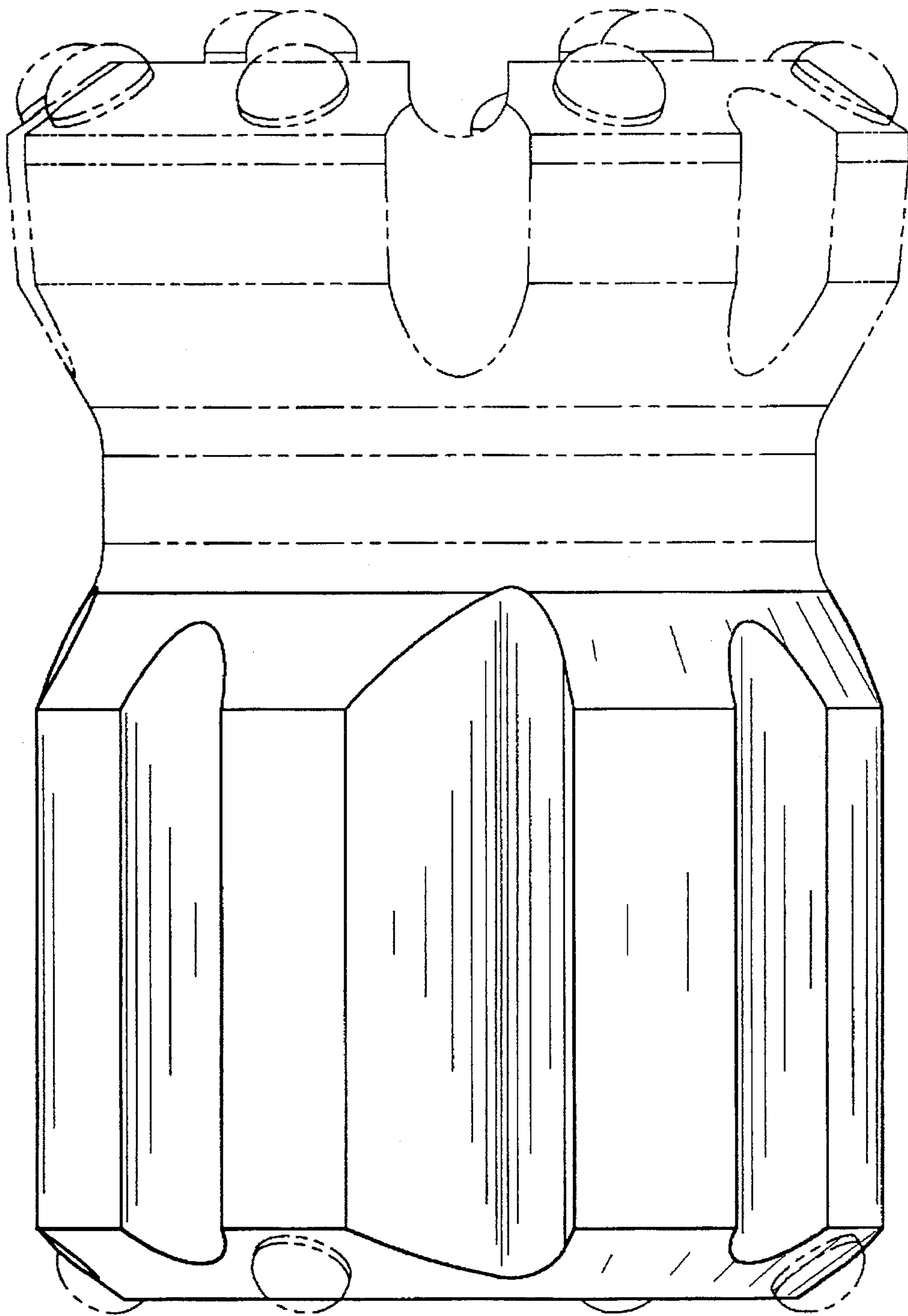

FIG. 5

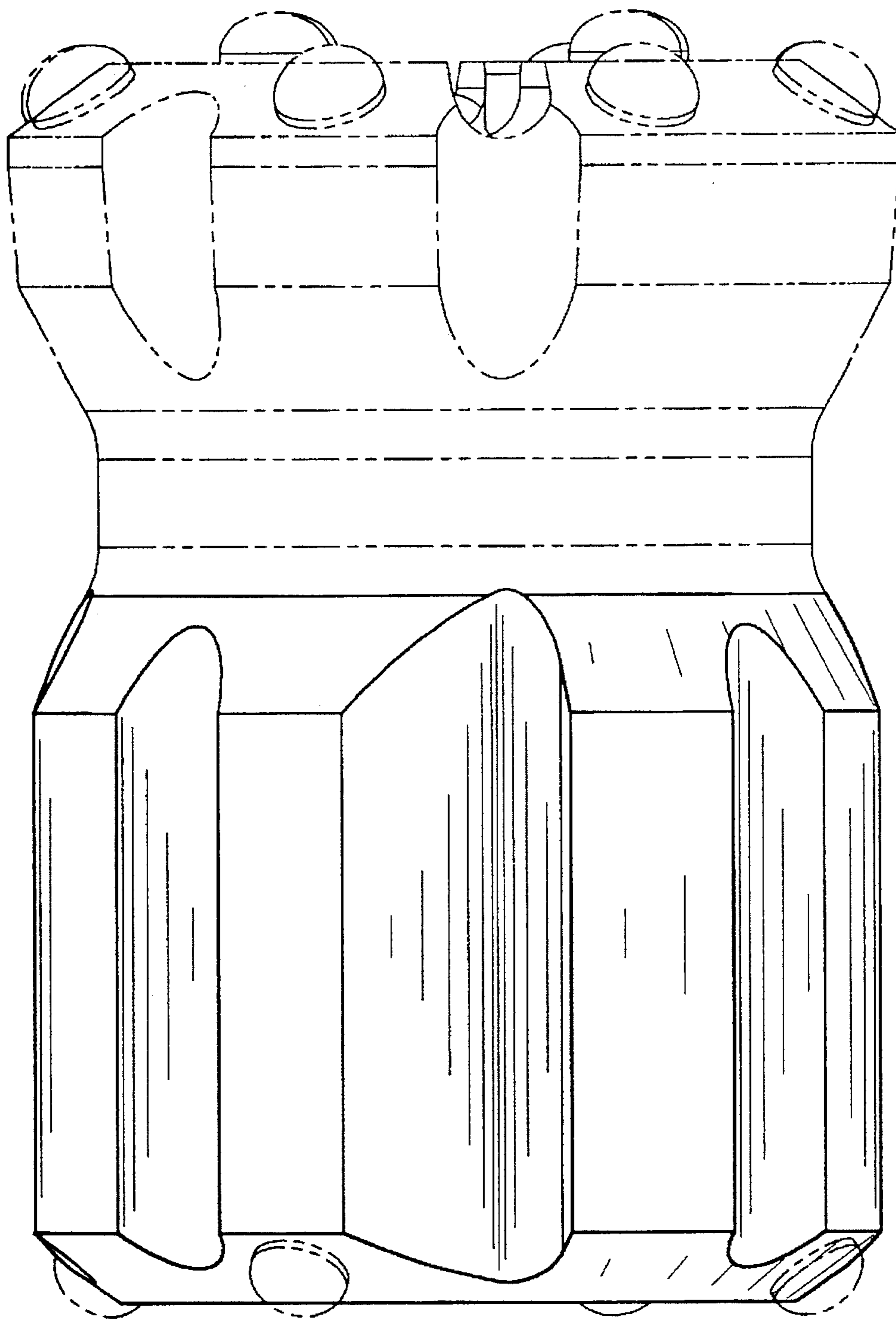

FIG. 6