



US00D382835S

United States Patent [19]

[11] Patent Number: **Des. 382,835**

Abe et al.

[45] Date of Patent: ****Aug. 26, 1997**

[54] **MOTORCYCLE BODY**

4,776,422 10/1988 Sakumo 180/219

[75] Inventors: **Karl-Heinz Abe**, Steinebach; **Klaus Volker Gevert**, Munich, both of Germany; **Martin Longmore**, London, Great Britain

OTHER PUBLICATIONS

Cycle World, Dec. 1993, pp. 40, The Kawasaki EX500 Ninja Motorcycle.

[73] Assignee: **Bayerische Motoren Werke AG**, Germany

Primary Examiner—Melody N. Brown
Attorney, Agent, or Firm—Evenson, McKeown, Edwards & Lenahan P.L.L.C.

[**] Term: **14 Years**

[57] **CLAIM**

[21] Appl. No.: **12,607**

The ornamental design for a motorcycle body, as shown and described.

[22] Filed: **Aug. 5, 1993**

DESCRIPTION

[30] **Foreign Application Priority Data**

Feb. 5, 1993 [DE] Germany M 9301110.5

FIG. 1 is a perspective view from the front and left side of the motorcycle body according to our novel design; FIG. 2 is a left side view of the motorcycle body according to our novel design; FIG. 3 is a right side view of the motorcycle body according to our novel design; FIG. 4 is a front view of the motorcycle body according to our novel design; FIG. 5 is a rear view of the motorcycle body according to our novel design; and, FIG. 6 is a top view of the motorcycle body according to our novel design.

[51] LOC (6) Cl. **12-11**

[52] U.S. Cl. **D12/110**

[58] Field of Search D12/110; 180/219

The details outlined in broken lines are for depicting the environment and are not part of the claimed design.

[56] **References Cited**

U.S. PATENT DOCUMENTS

- D. 275,469 9/1984 Morioka et al. D12/110
- D. 299,446 1/1989 Kohama et al. D12/110
- D. 299,447 1/1989 Sukuma et al. D12/110
- D. 332,588 1/1993 Kohama et al. D12/110
- D. 333,641 3/1993 Sakaguchi et al. D12/110
- D. 350,920 9/1994 Tsukui et al. D12/110

1 Claim, 5 Drawing Sheets

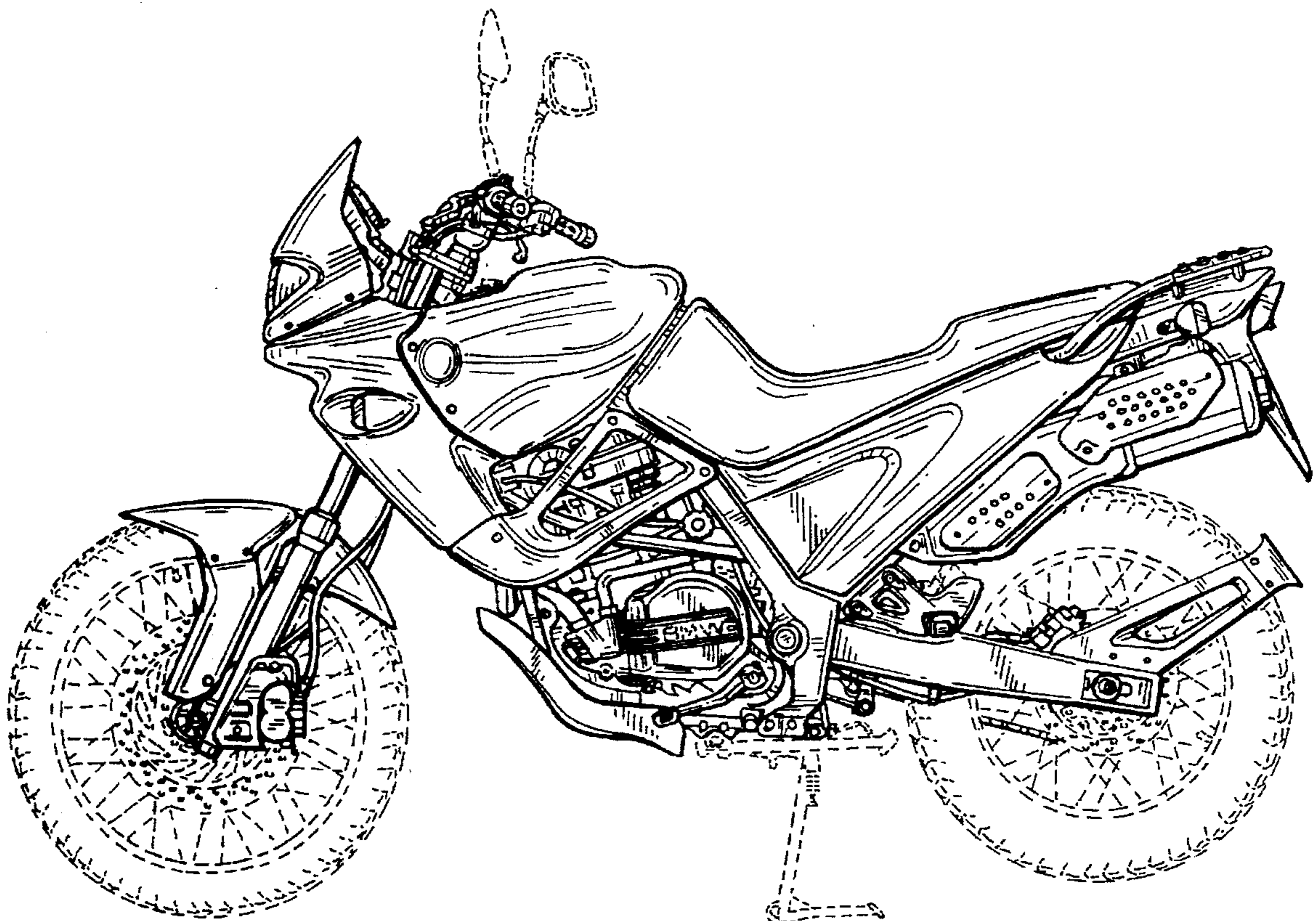

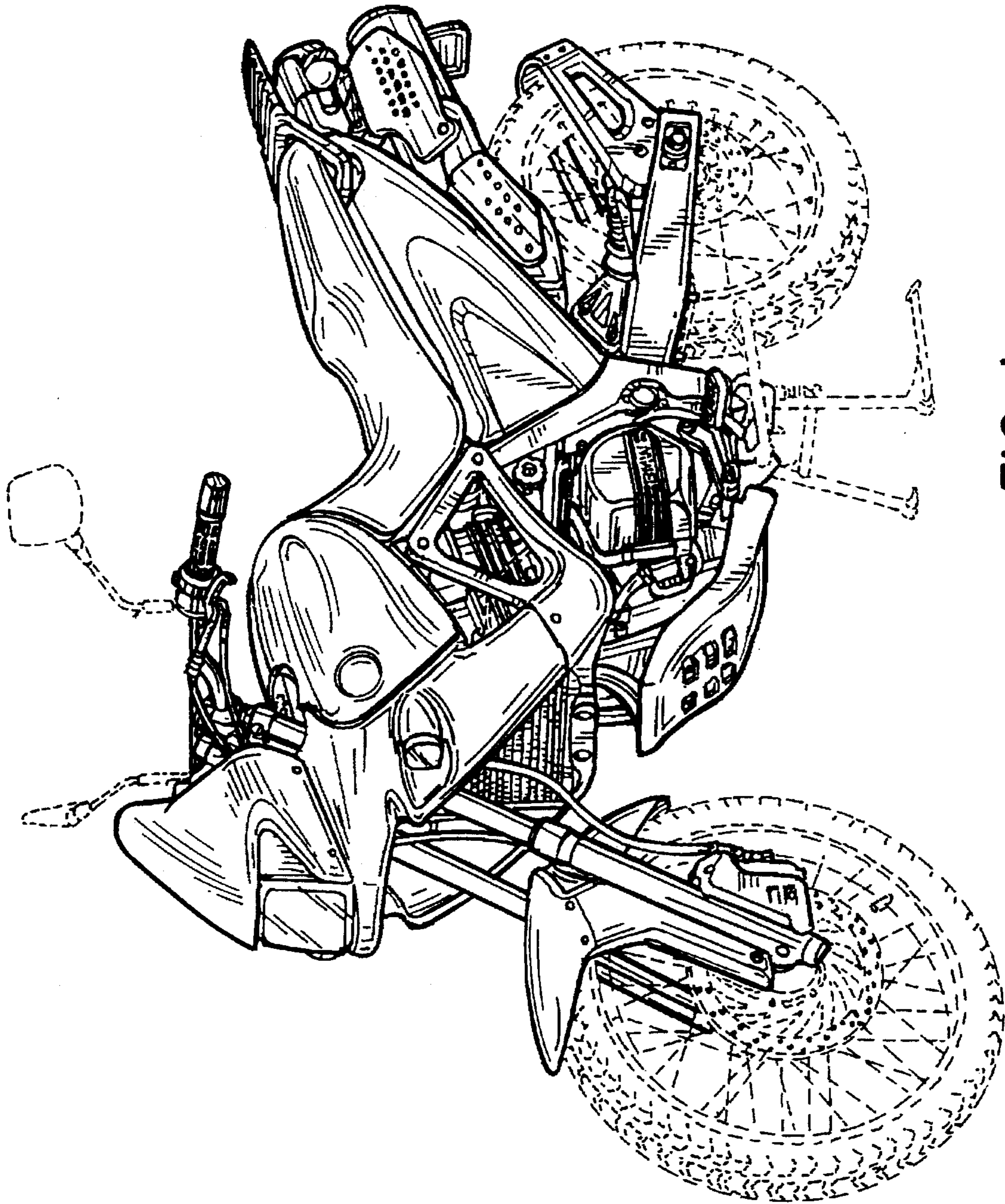

FIG. 1

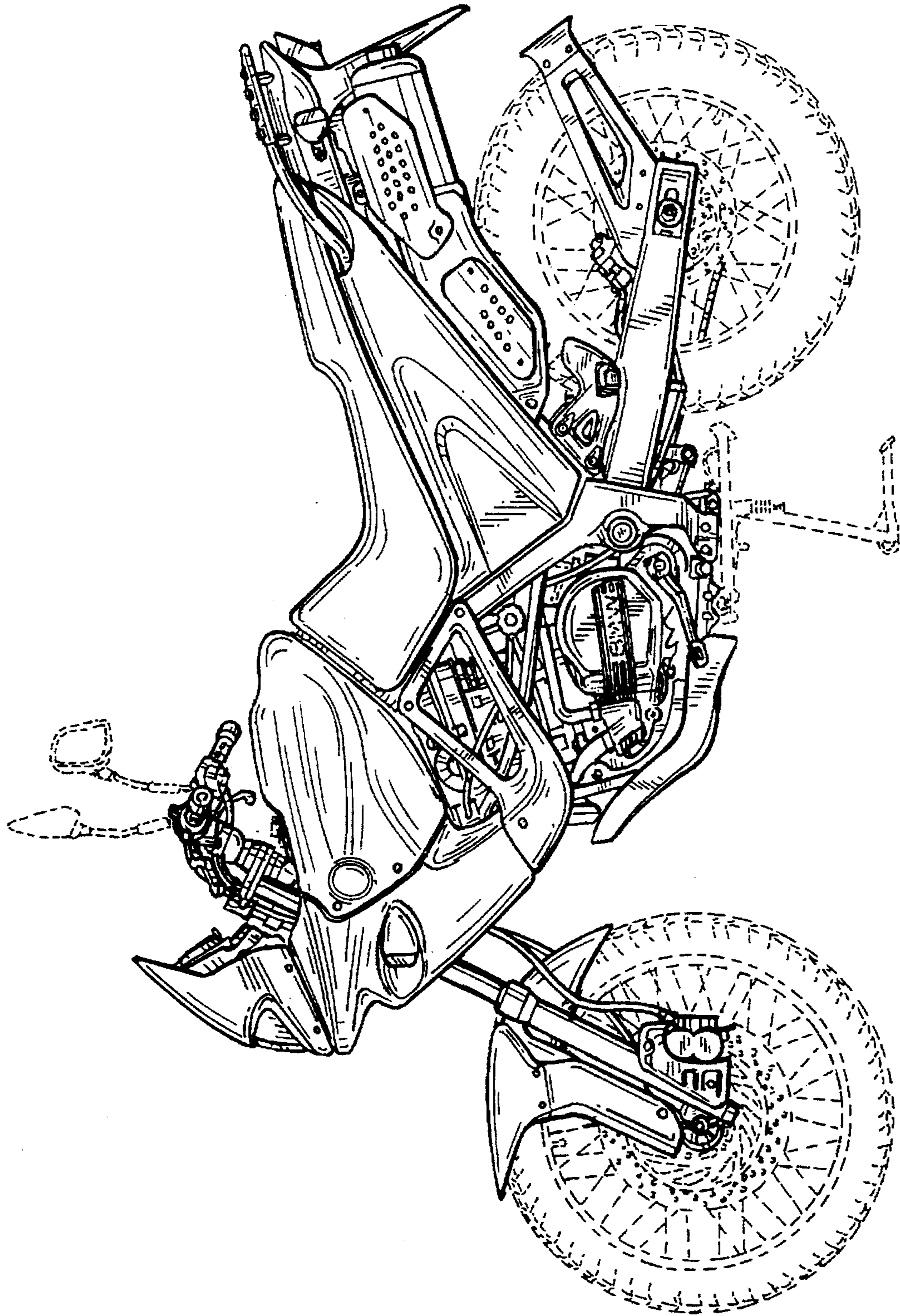

FIG. 2

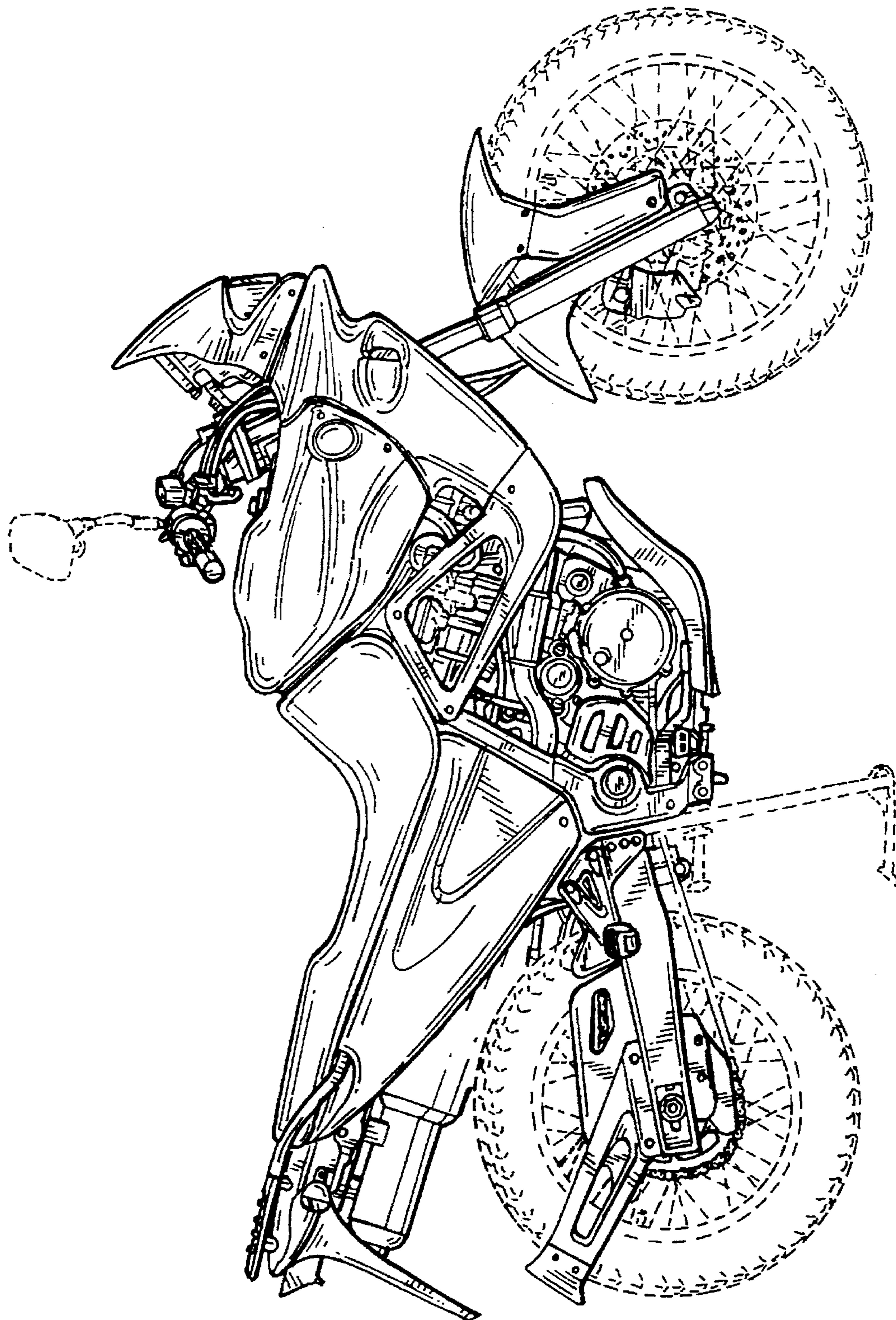

FIG. 3

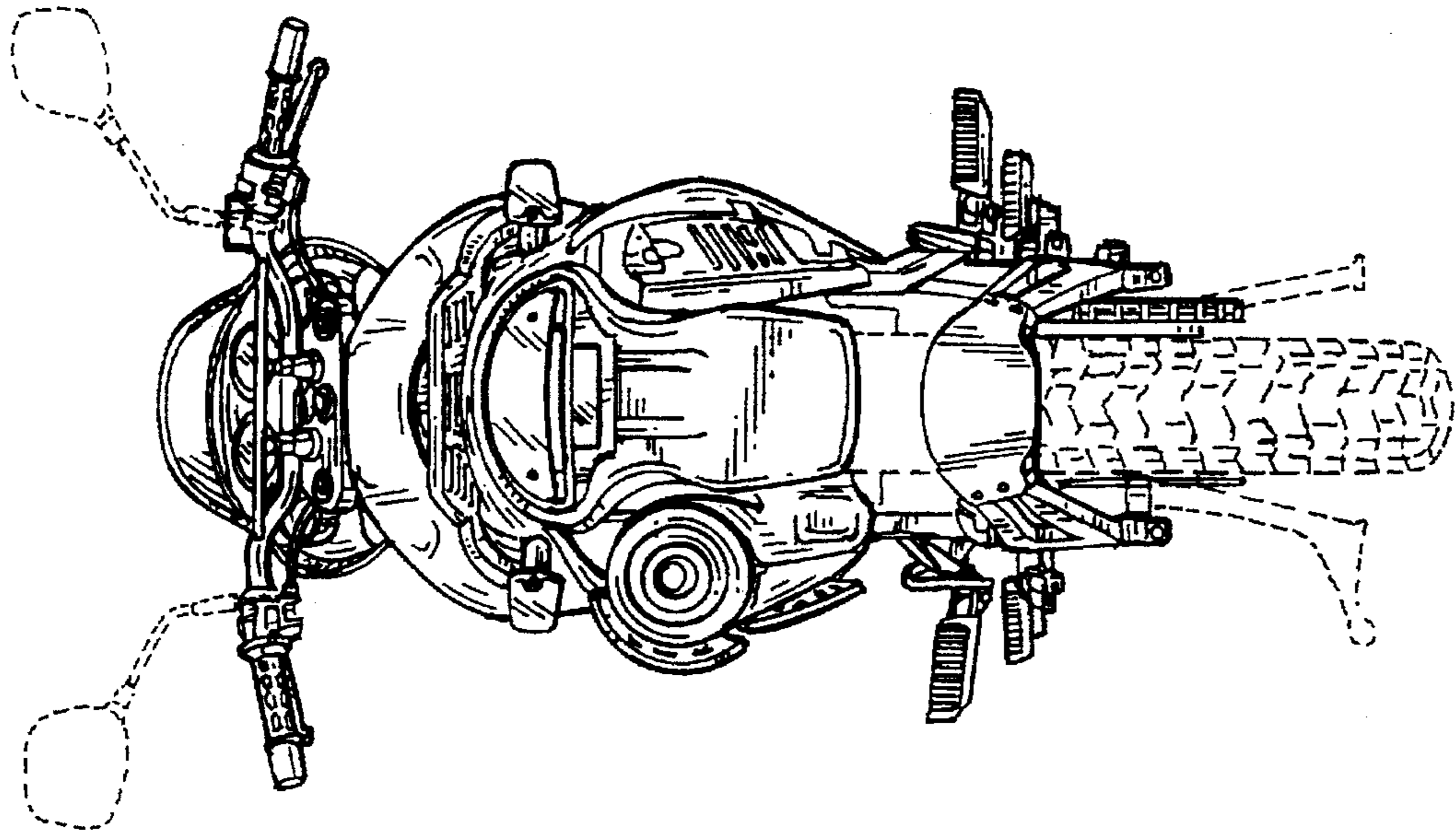

FIG. 5

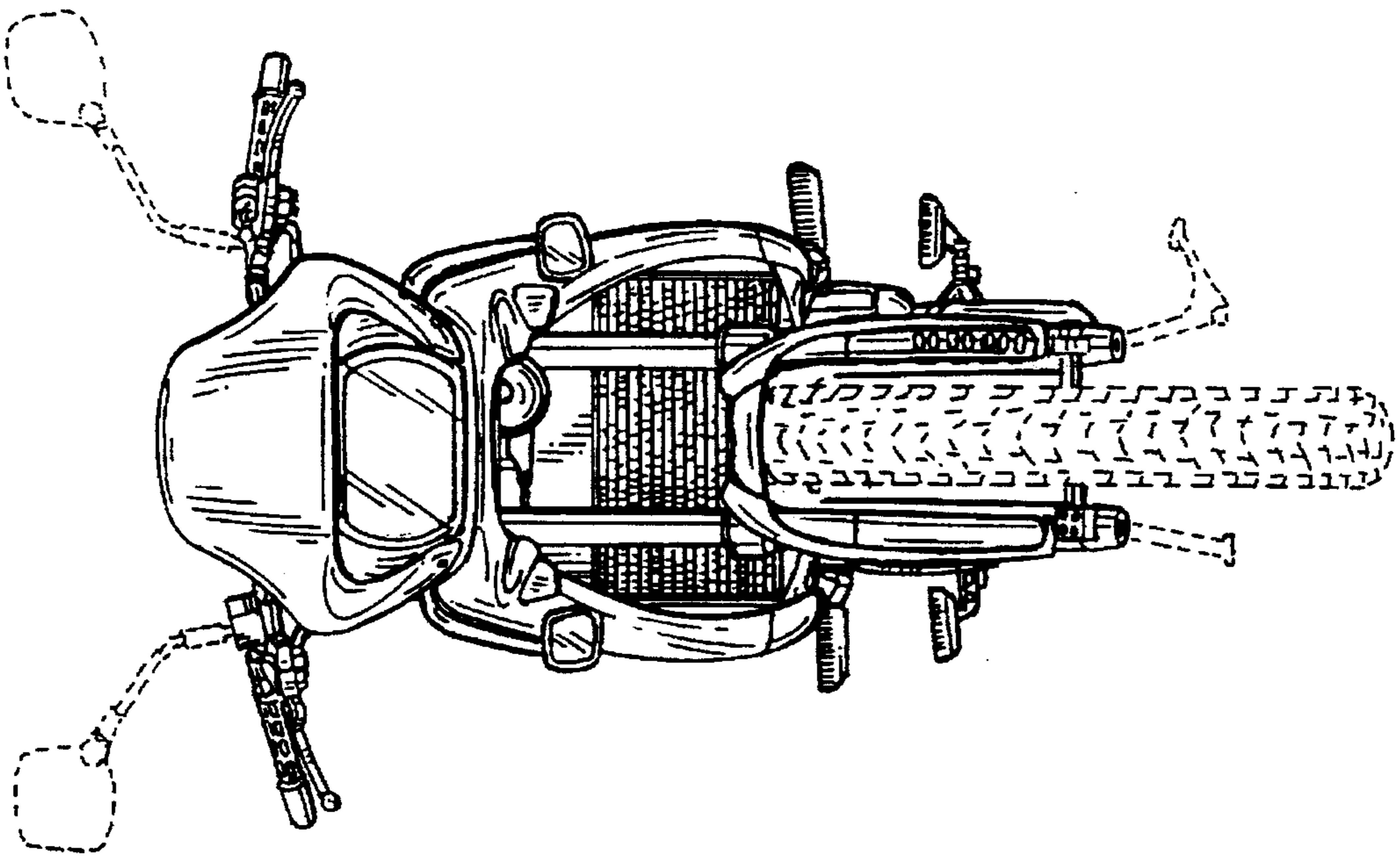

FIG. 4

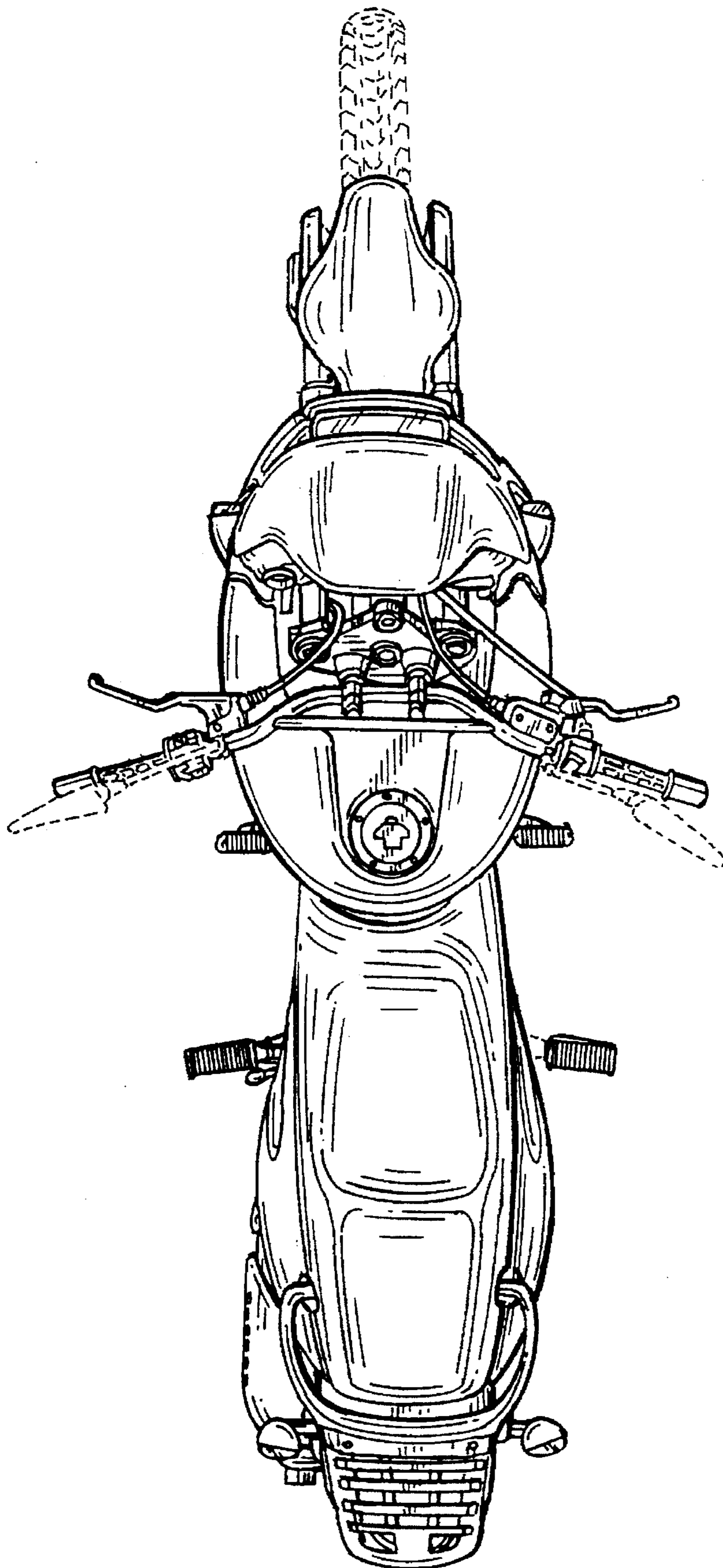

FIG. 6