



US00D382806S

United States Patent [19]

[11] Patent Number: Des. 382,806

Wilson et al.

[45] Date of Patent: **Aug. 26, 1997

- [54] SIDEWALLS FOR A BOTTLE
- [75] Inventors: **Missy Wilson**, New York, N.Y.; **Jeff Johnson**; **Chittamai Suvongse**, both of Minneapolis, Minn.
- [73] Assignee: **The Coca-Cola Company**, Atlanta, Ga.
- [**] Term: **14 Years**
- [21] Appl. No.: **46,186**
- [22] Filed: **Nov. 8, 1995**
- [51] LOC (6) Cl. **09-01**
- [52] U.S. Cl. **D9/502; D9/538; D9/557**
- [58] Field of Search D9/500, 502, 503, D9/504, 505, 545, 537-541, 557; 215/383, 384, 382, 400

- D. 201,999 8/1965 Rau .
- D. 206,831 1/1967 Hodgman .
- D. 209,019 10/1967 Neese .
- D. 209,715 12/1967 Ninesting .
- D. 210,445 3/1968 Bourke .
- D. 210,766 4/1968 Plummer .
- D. 217,336 4/1970 Meyers .
- D. 224,383 7/1972 Mascia .
- D. 228,445 9/1973 Stanley .
- D. 241,713 10/1976 Plummer D9/500
- D. 242,527 11/1976 Plummer .
- D. 249,330 9/1978 Pigeon .
- D. 250,170 11/1978 Strand .
- D. 264,433 5/1982 Pettengill .
- D. 269,500 6/1983 Bit .
- D. 271,747 12/1983 Kanise .
- D. 271,853 12/1983 Tsuno .
- D. 286,984 12/1986 Durand .
- D. 292,269 10/1987 Jacobs et al. .
- D. 295,376 4/1988 Rogler .
- D. 295,378 4/1988 Rogler .
- D. 296,764 7/1988 Riach et al. .
- D. 297,308 8/1988 Lyons .
- D. 306,262 2/1990 Bit .
- D. 306,967 4/1990 Matsuura et al. .

[56] References Cited

U.S. PATENT DOCUMENTS

- D. 24,324 5/1895 Estes .
- D. 60,555 3/1922 Marble .
- D. 67,189 5/1925 Curran .
- D. 069,992 4/1926 Grannan .
- D. 75,903 7/1928 Dupiech D9/538
- D. 82,578 9/1930 Oblander .
- D. 87,512 8/1932 Fuerst .
- D. 94,713 2/1935 Steuer D9/557 X
- D. 105,416 7/1937 Sherman .
- D. 111,242 9/1938 Dunn .
- D. 112,190 11/1938 Bireley .
- D. 144,810 5/1946 Schwartz .
- D. 150,490 8/1948 Brown .
- D. 159,616 8/1950 Hoffman D9/557
- D. 171,605 3/1954 Livingston D9/557
- D. 179,173 11/1956 Wilson .
- D. 179,736 2/1957 Lorenzen .
- D. 188,074 5/1960 Wunderly D9/500
- D. 188,134 6/1960 Neubauer .
- D. 190,058 4/1961 Koenigsberg .
- D. 195,103 4/1963 Houghton .
- D. 195,900 8/1963 Sterges .
- D. 195,907 8/1963 Roberts .
- D. 197,537 2/1964 Vanderhyde .
- D. 200,603 3/1965 Petitto .
- D. 201,260 6/1965 Roberts .

(List continued on next page.)

Primary Examiner—Lucy Lieberman
Attorney, Agent, or Firm—Dennis W. Braswell

[57] CLAIM

The ornamental design for sidewalls for a bottle, as shown and described.

DESCRIPTION

FIG. 1 is a perspective view of sidewalls for a bottle showing our new design;
 FIG. 2 is a left side elevational view thereof;
 FIG. 3 is a right side elevational view thereof;
 FIG. 4 is a front view thereof;
 FIG. 5 is a back view thereof;
 FIG. 6 is a top elevational view thereof; and,
 FIG. 7 is a bottom plan view thereof.
 The broken lines showing the bottom of the bottle and the neck are for illustrative purposes only and do not form part of the claimed design.

1 Claim, 2 Drawing Sheets

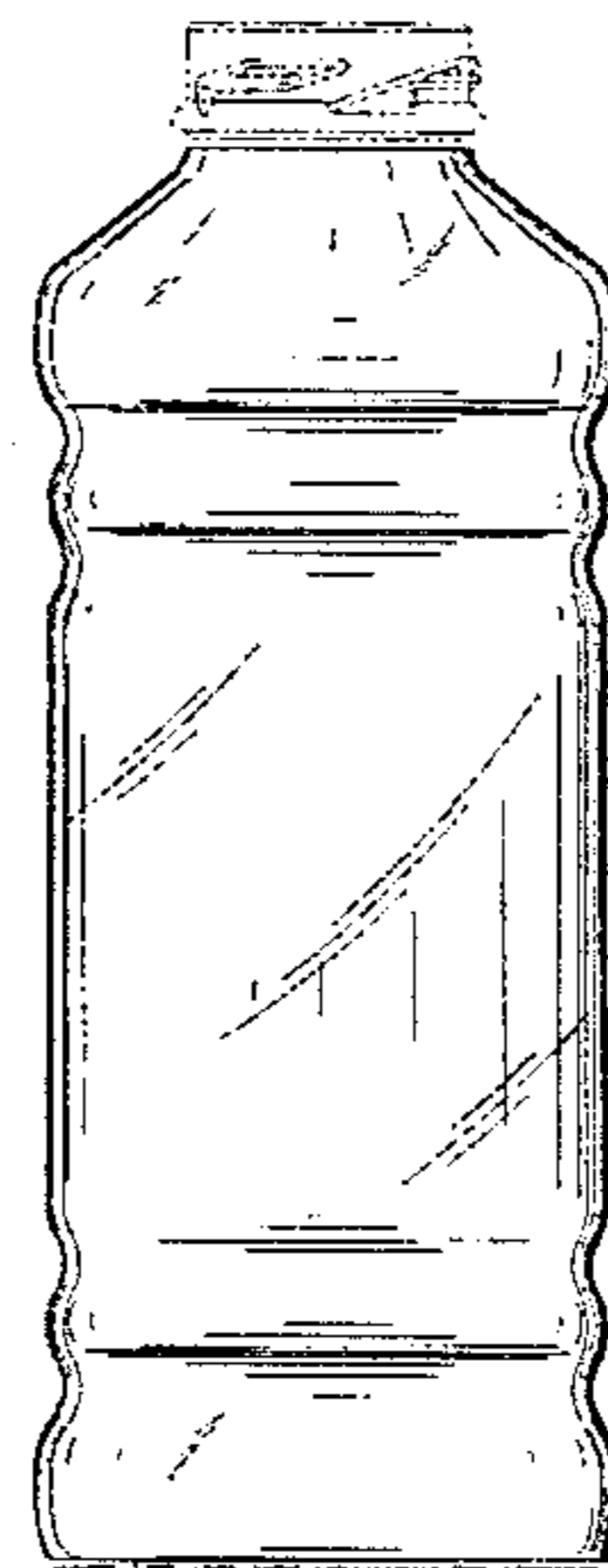

U.S. PATENT DOCUMENTS

D. 308,482	6/1990	Wild .	D. 337,724	7/1993	Bostwich et al. .
D. 308,484	6/1990	Browton .	D. 339,517	9/1993	Jobit .
D. 313,746	1/1991	Hoenig .	D. 347,793	6/1994	Wegner, IV et al. .
D. 313,931	1/1991	Malvoisin .	D. 348,837	7/1994	Feen .
D. 314,138	1/1991	Malvoisin .	D. 353,543	12/1994	Matsumoto .
D. 328,430	8/1992	Miller .	D. 356,506	3/1995	Kornick et al. .
D. 329,383	9/1992	Boucheron .	D. 358,099	5/1995	Weiss .
D. 331,367	12/1992	Armstrong .	D. 362,188	9/1995	Van Dyk .
D. 332,920	2/1993	Tiramani et al. .	D. 365,277	12/1995	Hencher D9/539
D. 334,342	3/1993	Thompson .	3,321,096	5/1967	Hebel .
D. 335,084	4/1993	Snyder D9/539 X	3,331,521	7/1967	Paige 215/384
			3,923,178	12/1975	Welker, III .

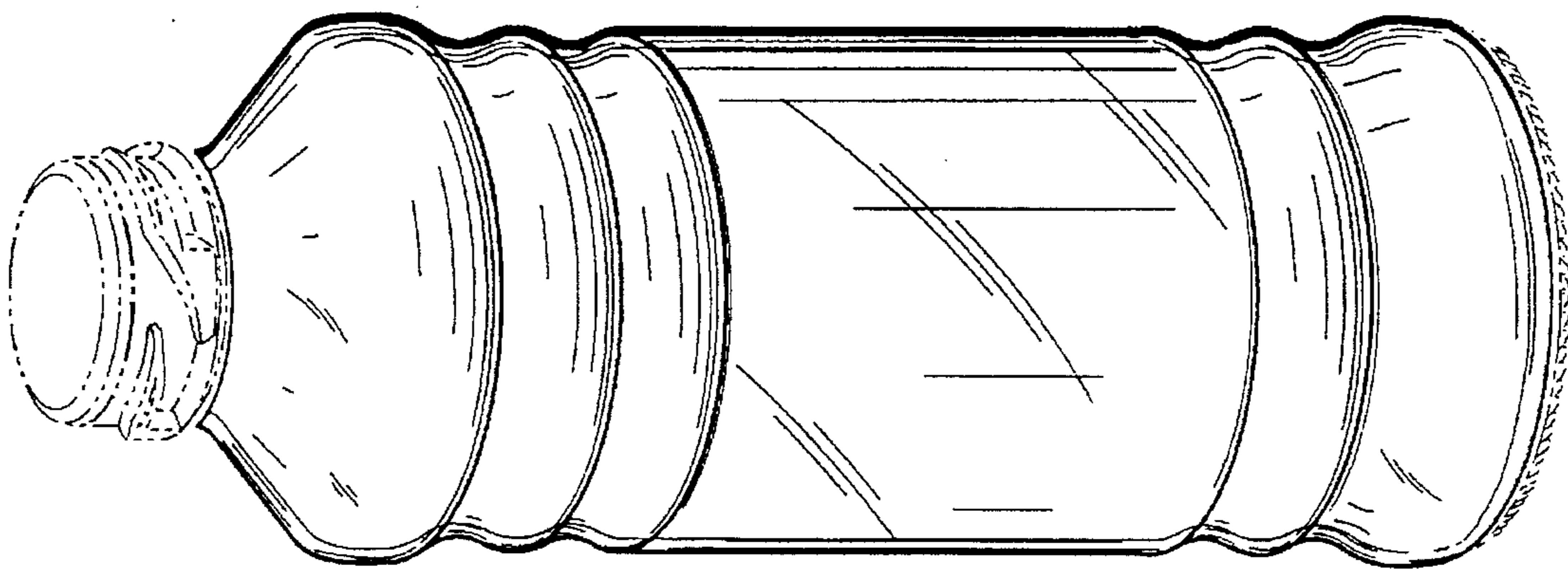

FIG. 1

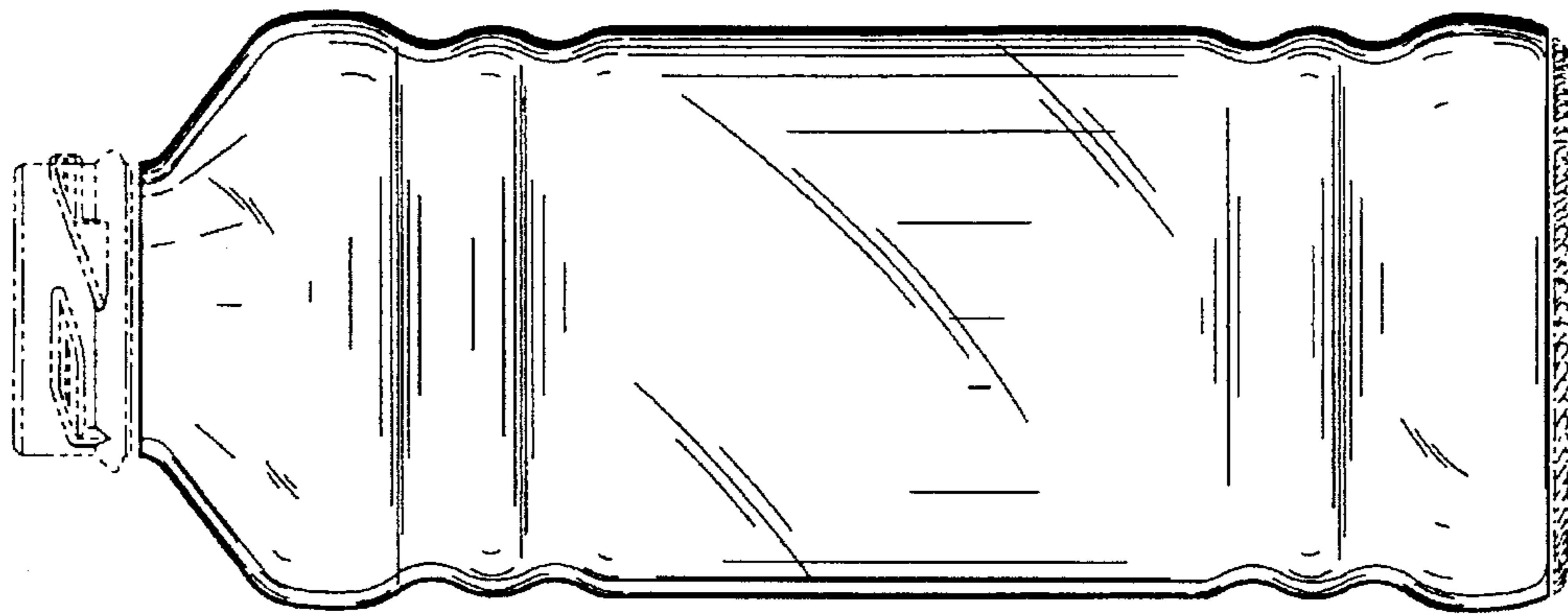

FIG. 2

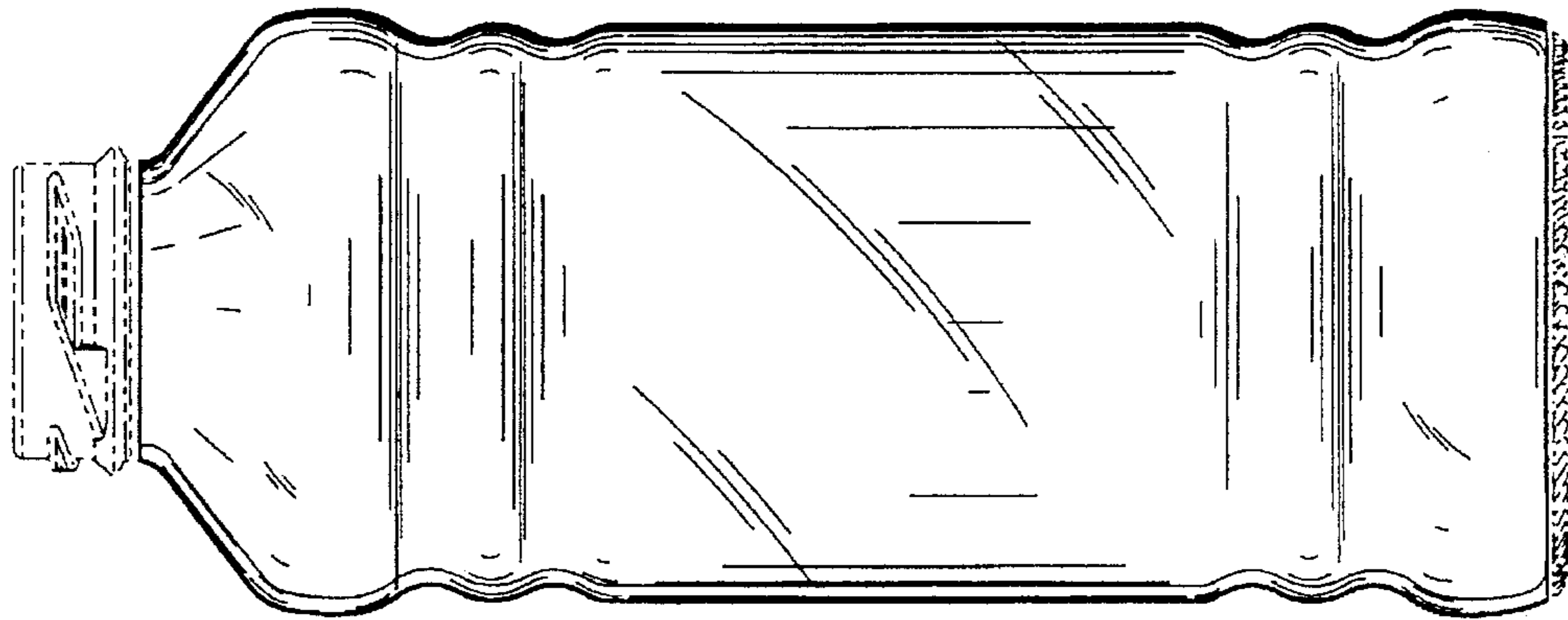

FIG. 3

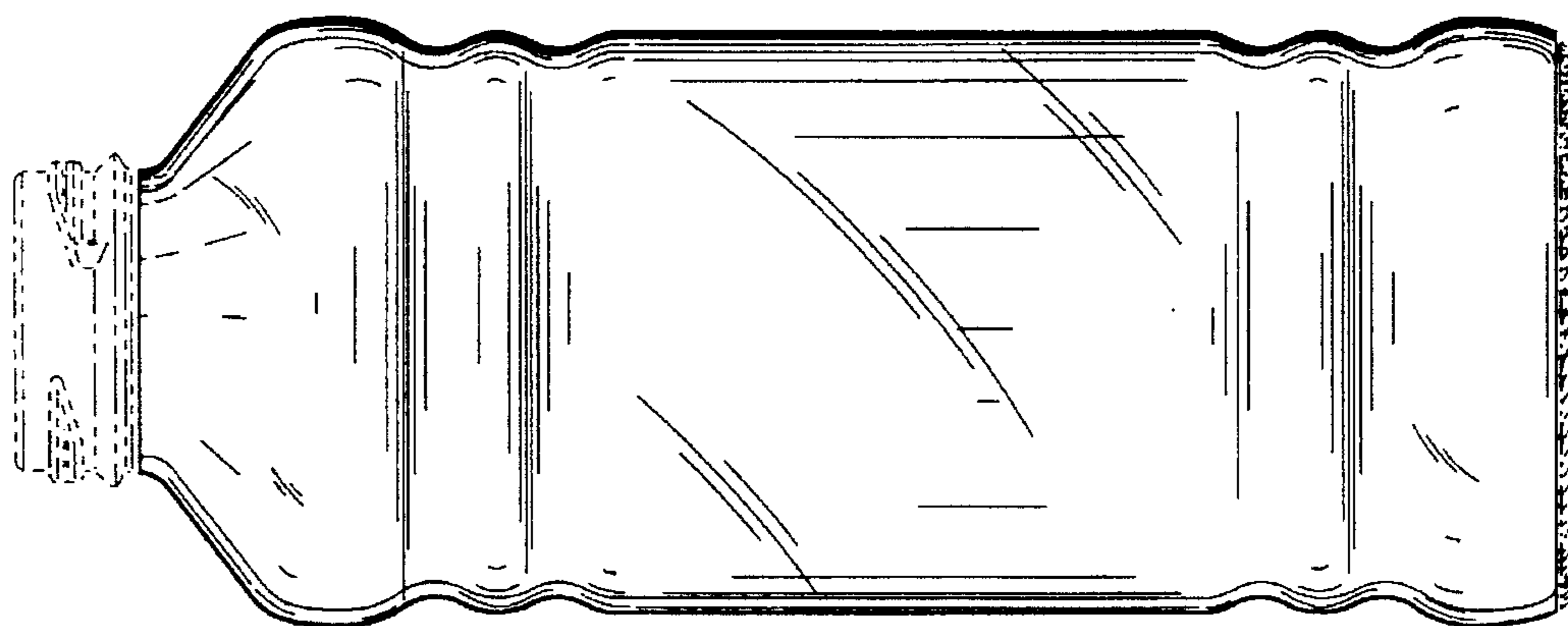

FIG. 4

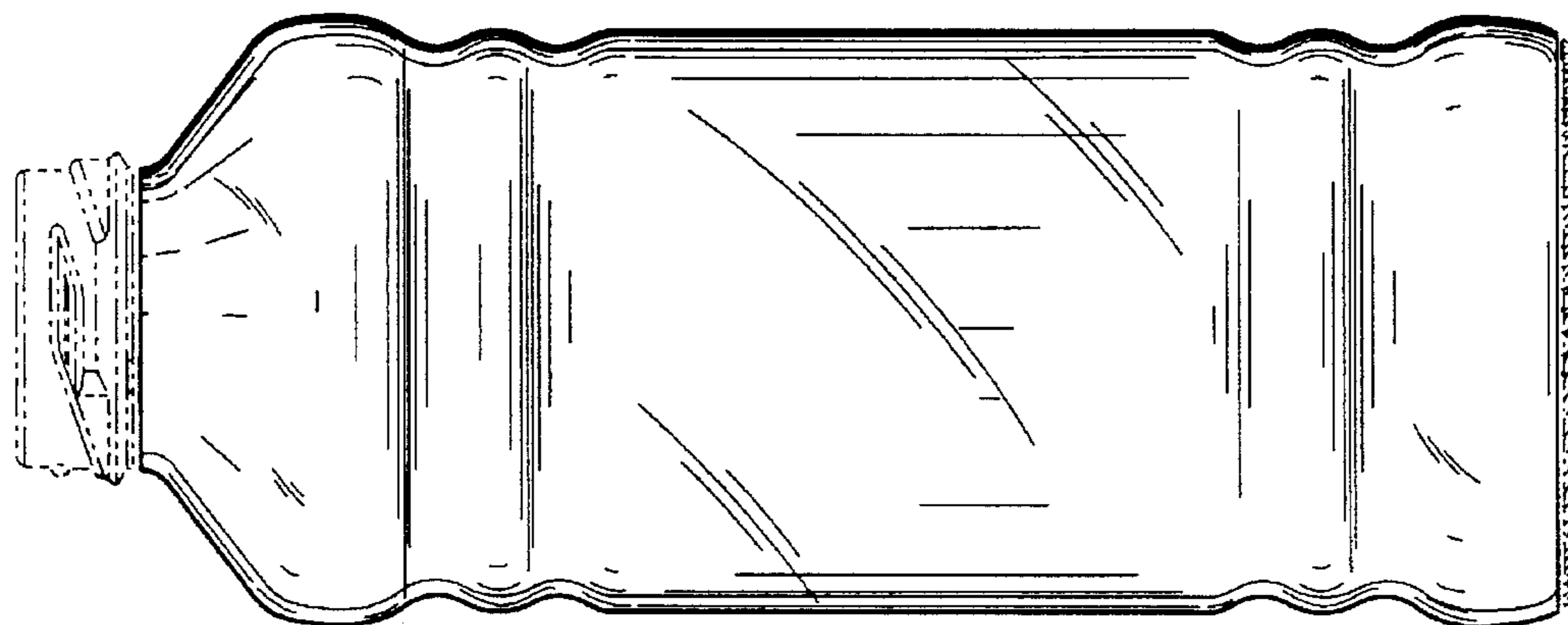

FIG. 5

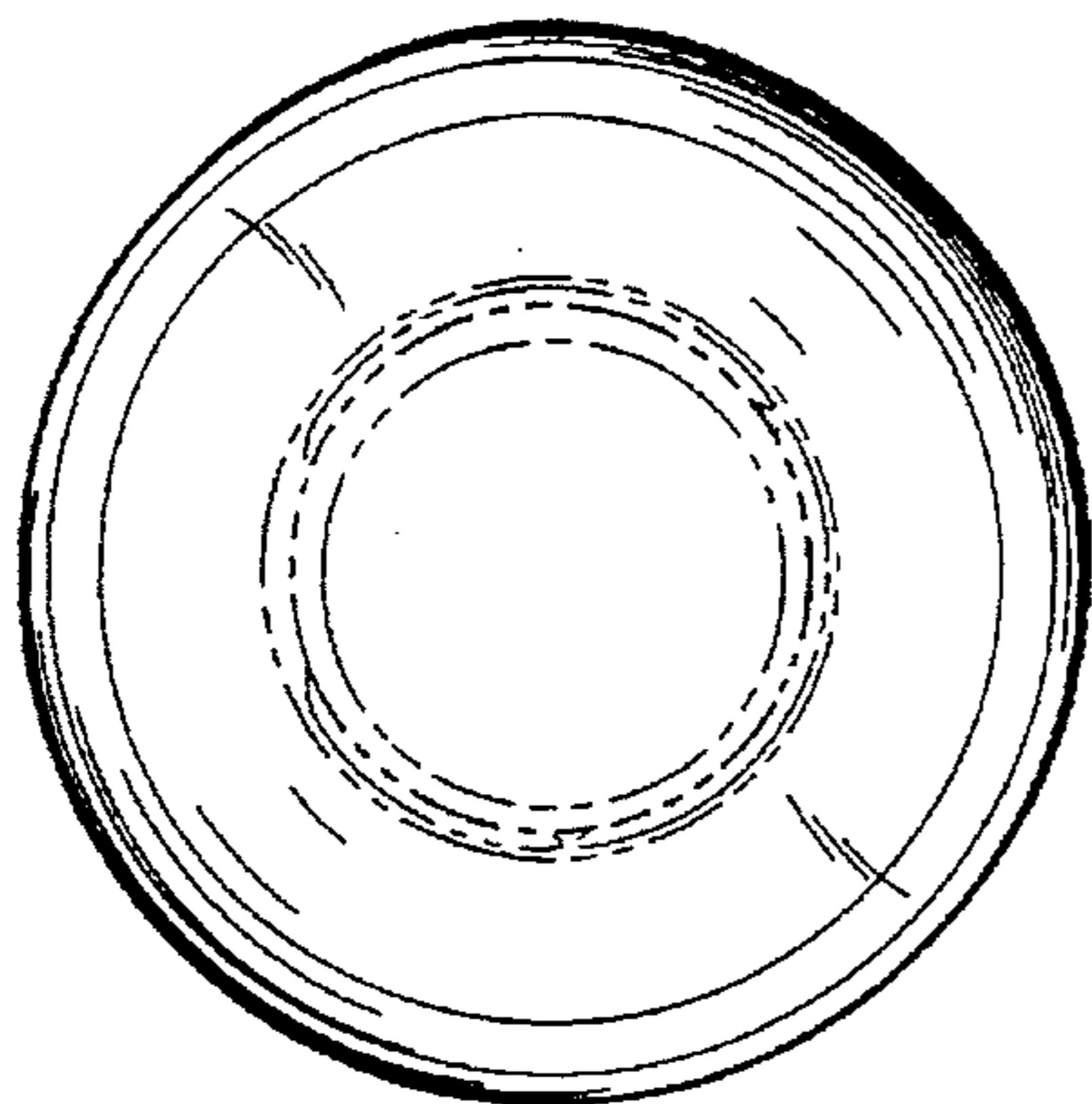

FIG. 6

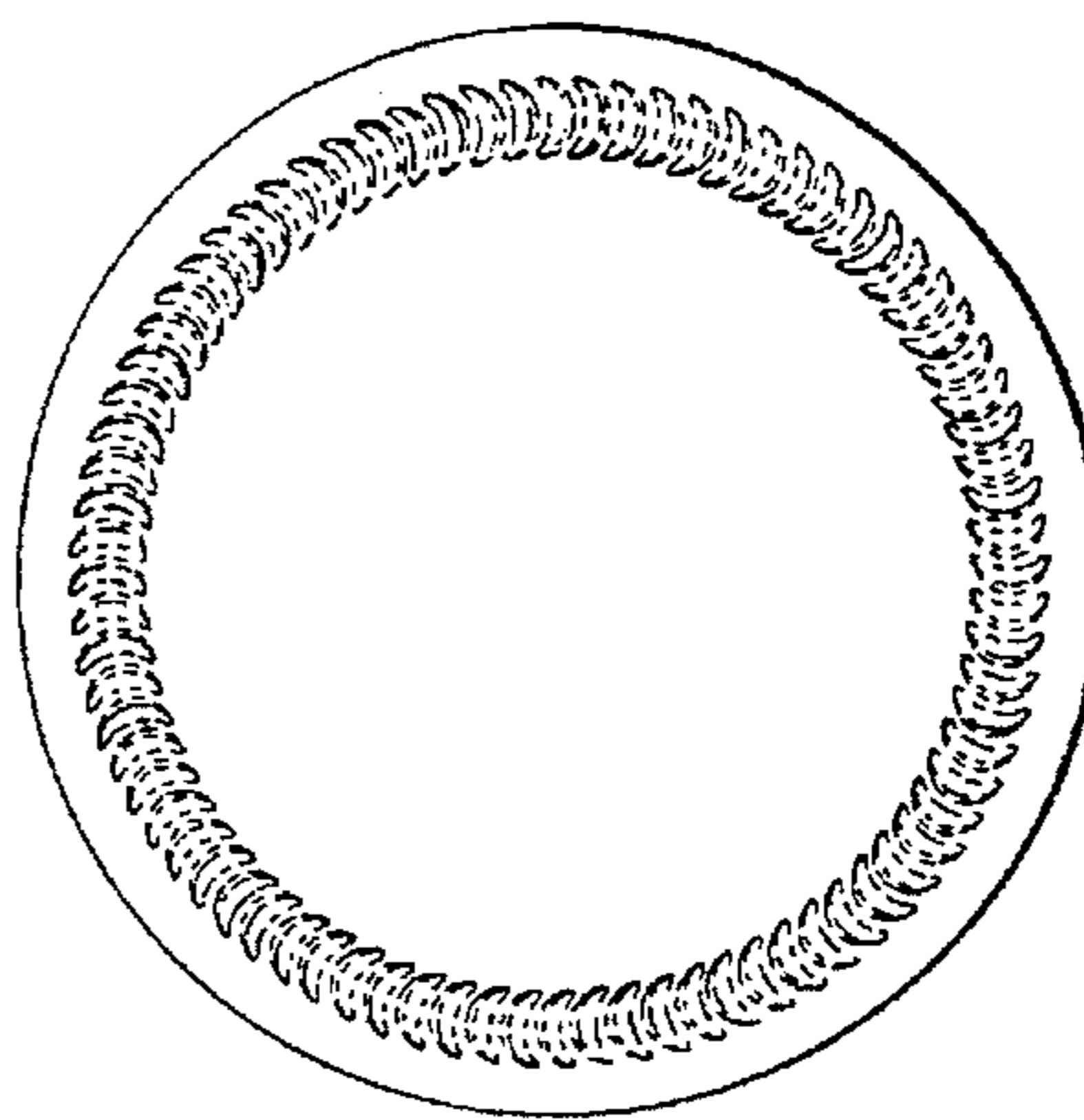

FIG. 7