



US00D382805S

United States Patent [19] Knickerbocker

[11] Patent Number: **Des. 382,805**

[45] Date of Patent: ****Aug. 26, 1997**

[54] **PROTECTIVE CAP FOR FINGER PUMP**

[75] Inventor: **Michael G. Knickerbocker**, Crystal Lake, Ill.

[73] Assignee: **Aptargroup**, Cary, Ill.

[**] Term: **14 Years**

[21] Appl. No.: **30,615**

[22] Filed: **Nov. 3, 1994**

[51] LOC (6) Cl. **09-01**

[52] U.S. Cl. **D9/445**

[58] **Field of Search** D7/590; D9/301, D9/306, 377, 406, 434-5, 447-8, 452-4, 499, 556, 443-5; 215/1 C, 1 R, 209, 216, 224; 220/256-7, 337, 377, 915; 222/485, 517

[56] **References Cited**

U.S. PATENT DOCUMENTS

D. 35,499	12/1901	Heunisch	D9/452
D. 54,749	3/1920	Huntley	D9/556
D. 98,626	2/1936	Smith	D9/453
D. 121,678	7/1940	Jung	D9/453
D. 138,080	6/1944	Derham	D9/453
D. 152,184	12/1948	Baron	D9/453
D. 162,894	4/1951	Soffer	D9/443
D. 204,822	5/1966	Barker	D9/444
D. 249,644	9/1978	Oeckl	D7/950
D. 255,550	6/1980	Kirk, Jr.	D9/448
D. 280,600	9/1985	Earl	D9/454
D. 284,353	6/1986	Prabs	D9/453
D. 292,967	12/1987	Gagnon	D9/439
D. 295,956	5/1988	Holewinski et al.	D9/556
D. 327,431	6/1992	Farricielli	D9/444
D. 327,432	6/1992	Farricielli	D9/444
D. 328,429	8/1992	Ben-Uni	D9/444
3,207,375	9/1965	Bereziat et al.	D9/447
3,854,632	12/1974	Smrt	
4,036,397	7/1977	Walraven et al.	220/337
4,114,811	9/1978	Loeffler	
4,141,445	2/1979	Korich	
4,158,361	6/1979	Kotuby	
4,186,853	2/1980	White	
4,226,339	10/1980	Landsman et al.	

4,386,712	6/1983	DeWallace	215/216
4,426,025	1/1984	Knickerbocker	
5,027,982	7/1991	Demarest	
5,040,694	8/1991	Gambello	
5,207,657	5/1993	Gibilisco	

Primary Examiner—James Gandy
Assistant Examiner—Robert M. Spear
Attorney, Agent, or Firm—Frijouf, Rust & Pyle P.A.

[57] **CLAIM**

The ornamental design for a protective cap for finger pump, as shown and described.

DESCRIPTION

FIG. 1 is a front view of a first embodiment of my new design for a protective cap for finger pump;
 FIG. 2 is a rear view thereof;
 FIG. 3 is a left side view thereof;
 FIG. 4 is a right side view thereof;
 FIG. 5 is a top view thereof;
 FIG. 6 is a bottom view thereof;
 FIG. 7 is a sectional view along line 7—7 in FIG. 5;
 FIG. 8 is a sectional view along line 8—8 in FIG. 5;
 FIG. 9 is a front view of a second embodiment of my new design for a protective cap for finger pump;
 FIG. 10 is a rear view thereof;
 FIG. 11 is a left side view thereof;
 FIG. 12 is a right side view thereof;
 FIG. 13 is a top view thereof;
 FIG. 14 is a bottom view thereof;
 FIG. 15 is a sectional view along line 15—15 in FIG. 13;
 FIG. 16 is a front view of a third embodiment of my new design for a protective cap for finger pump;
 FIG. 17 is a rear view thereof;
 FIG. 18 is a left side view thereof;
 FIG. 19 is a right side view thereof;
 FIG. 20 is a top view thereof;
 FIG. 21 is a bottom view thereof;
 FIG. 22 is a sectional view along line 22—22 in FIG. 20;
 FIG. 23 is a front view of a fourth embodiment of my new design for a protective cap for finger pump;
 FIG. 24 is a rear view thereof;
 FIG. 25 is a left side view thereof;
 FIG. 26 is a right side view thereof;
 FIG. 27 is a top view thereof;

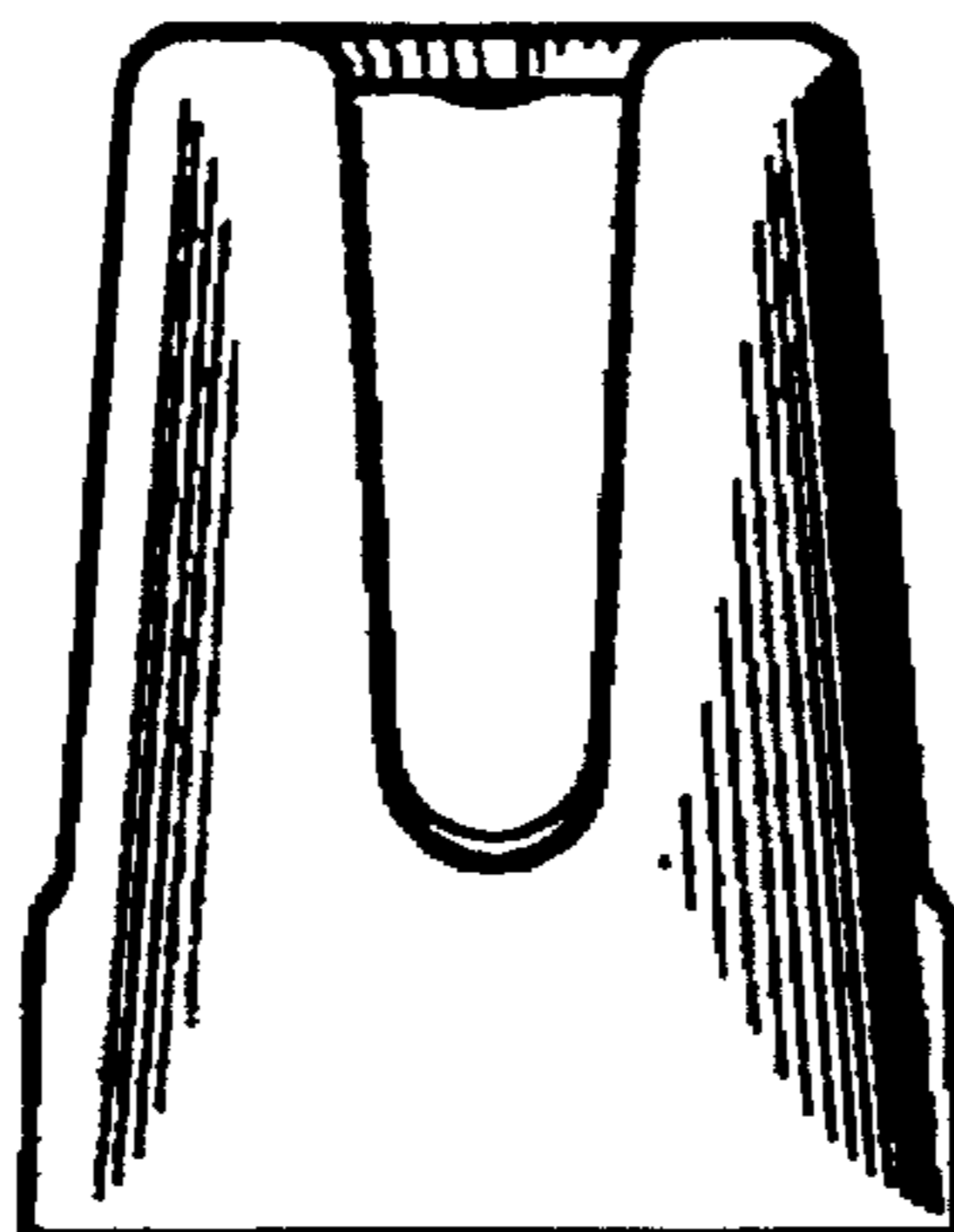

FIG. 28 is a bottom view thereof;
FIG. 29 is a sectional view along line 29—29 in FIG. 27;
FIG. 30 is a sectional view along line 30—30 in FIG. 27;
FIG. 31 is a front view of fifth embodiment of my new design for a protective cap for finger pump;
FIG. 32 is a rear view thereof;
FIG. 33 is a left side view thereof;
FIG. 34 is a right side view thereof;

FIG. 35 is a top view thereof;
FIG. 36 is a bottom view thereof;
FIG. 37 is a sectional view along line 37—37 in FIG. 35;
and,
FIG. 38 is a sectional view along line 38—38 in FIG. 35.

1 Claim, 5 Drawing Sheets

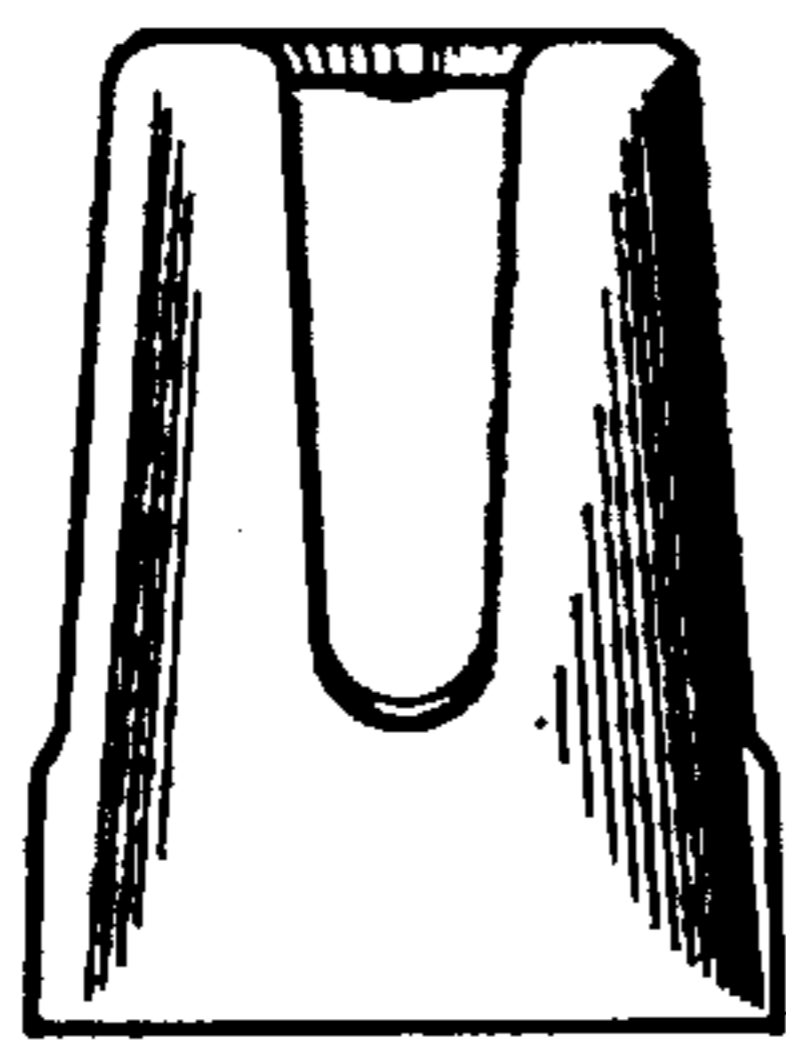

FIG. 1

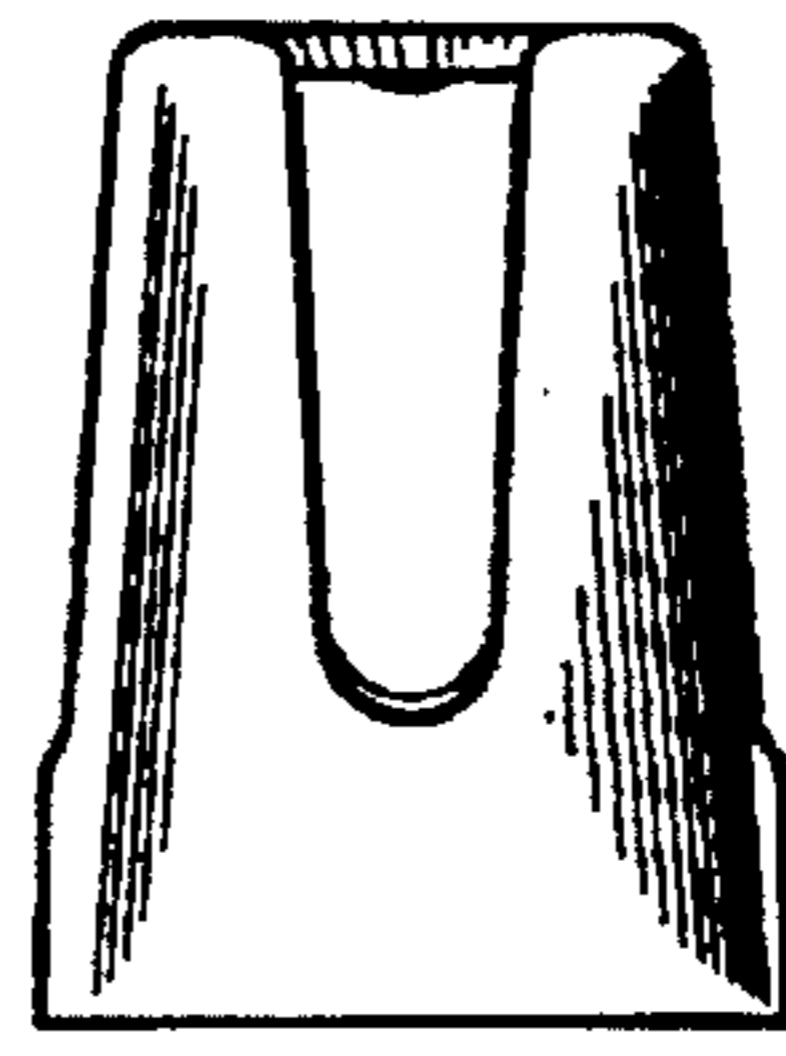

FIG. 2

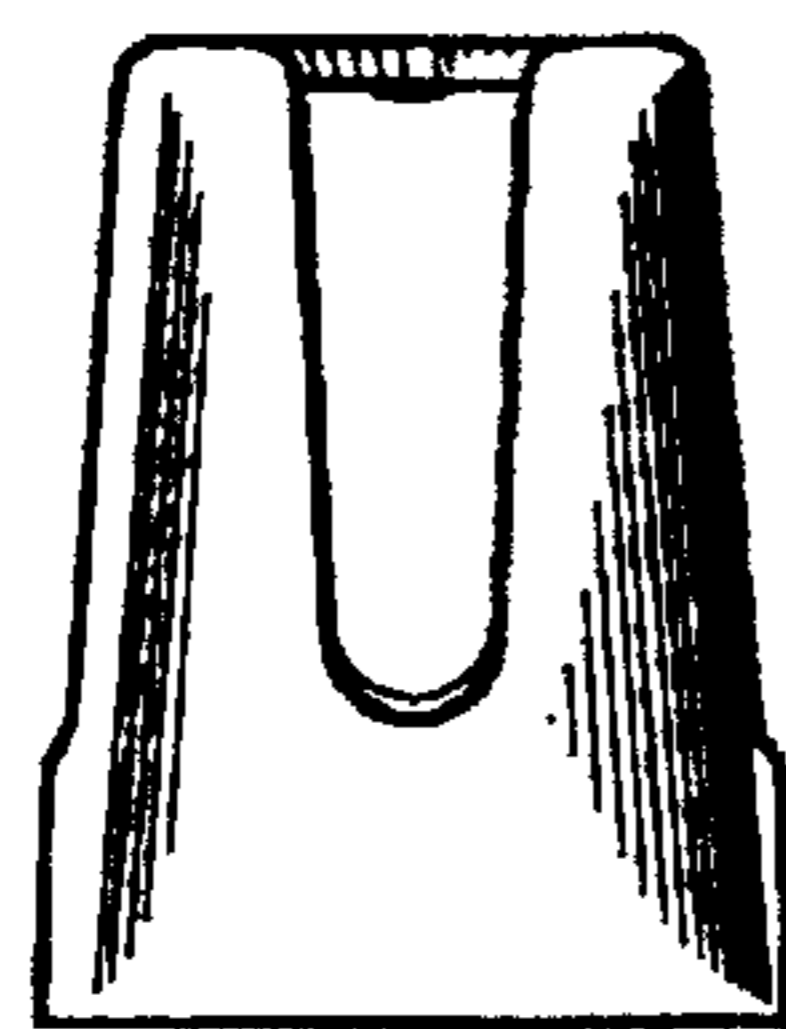

FIG. 3

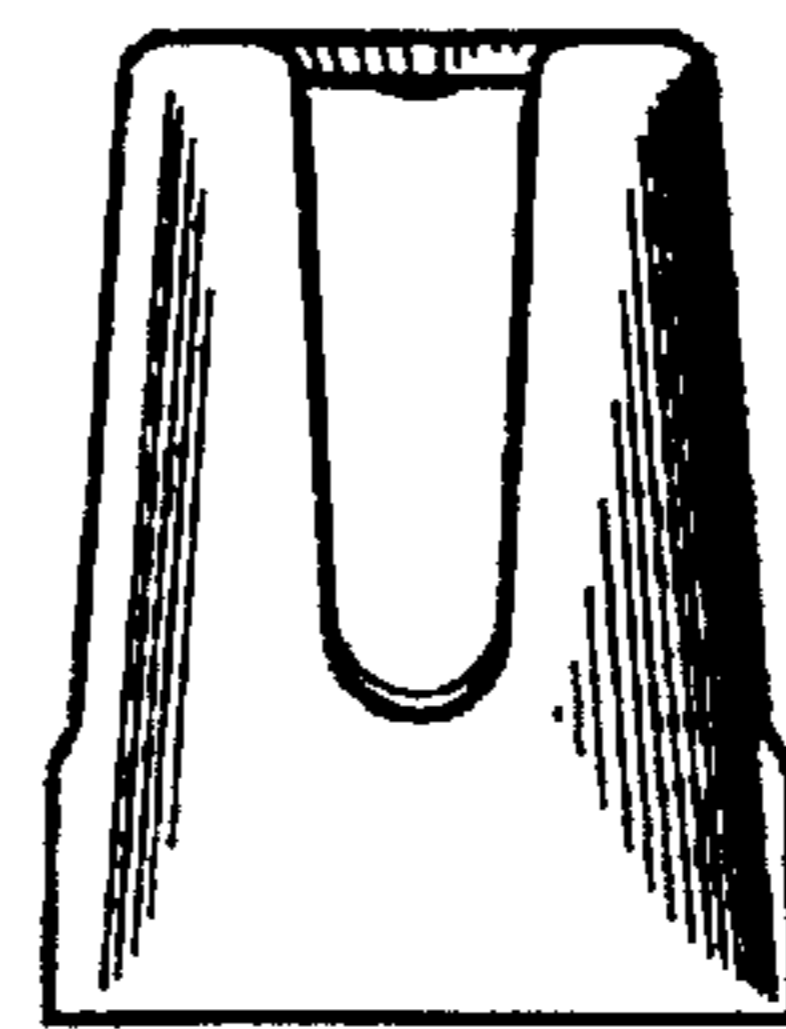

FIG. 4

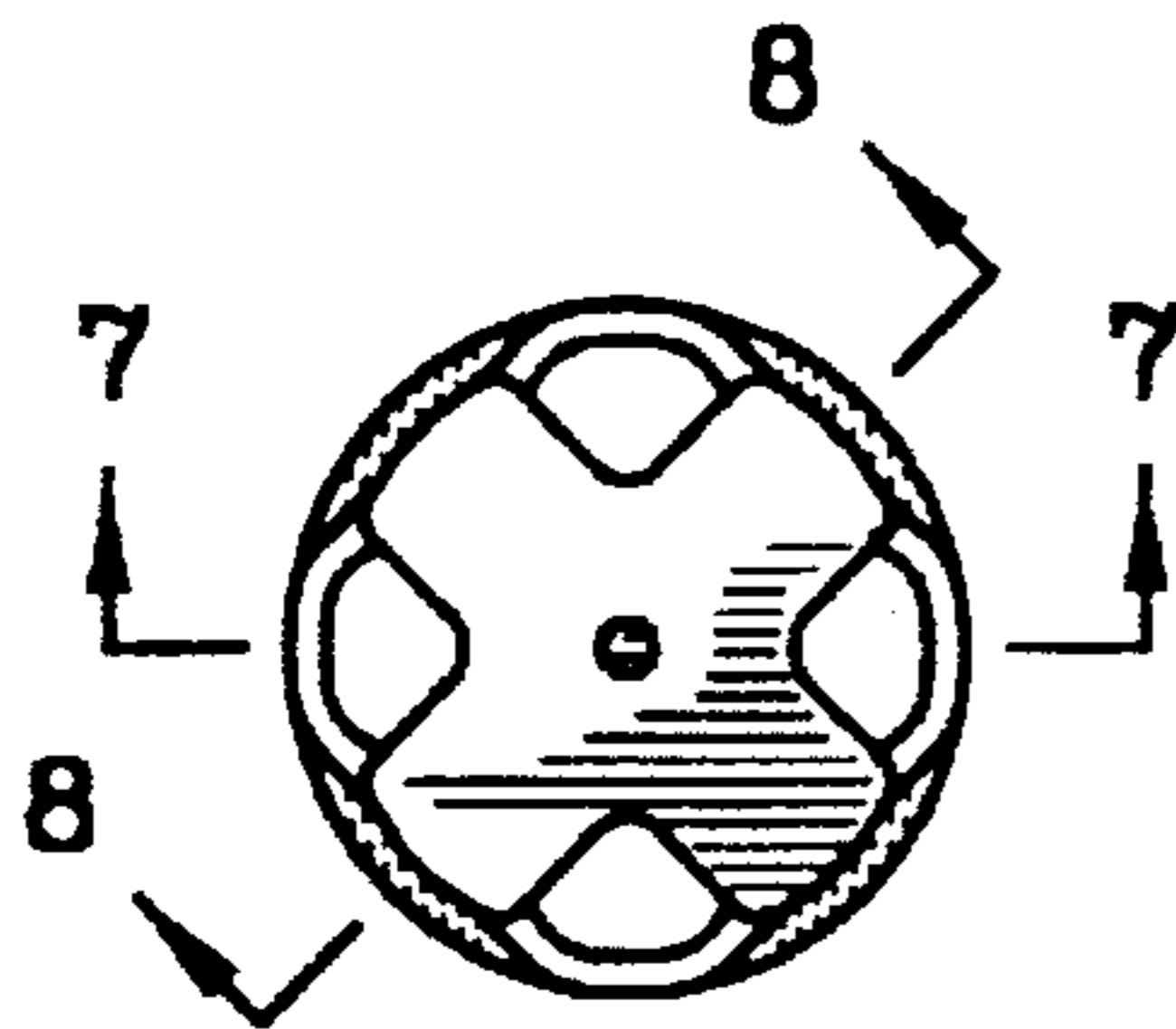

FIG. 5

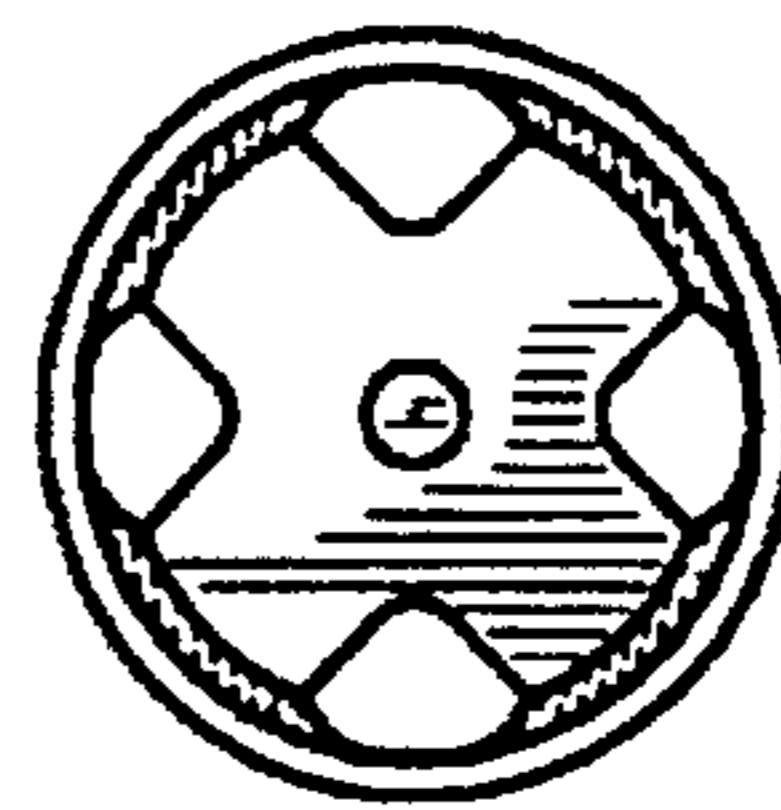

FIG. 6

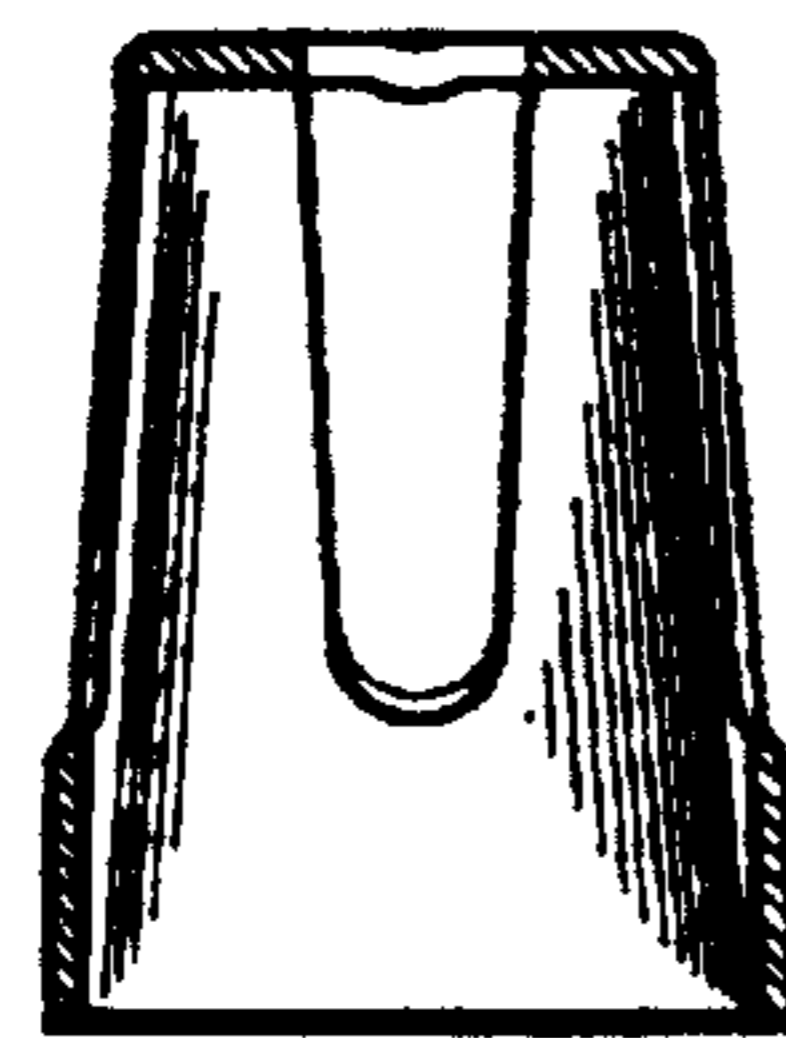

FIG. 7

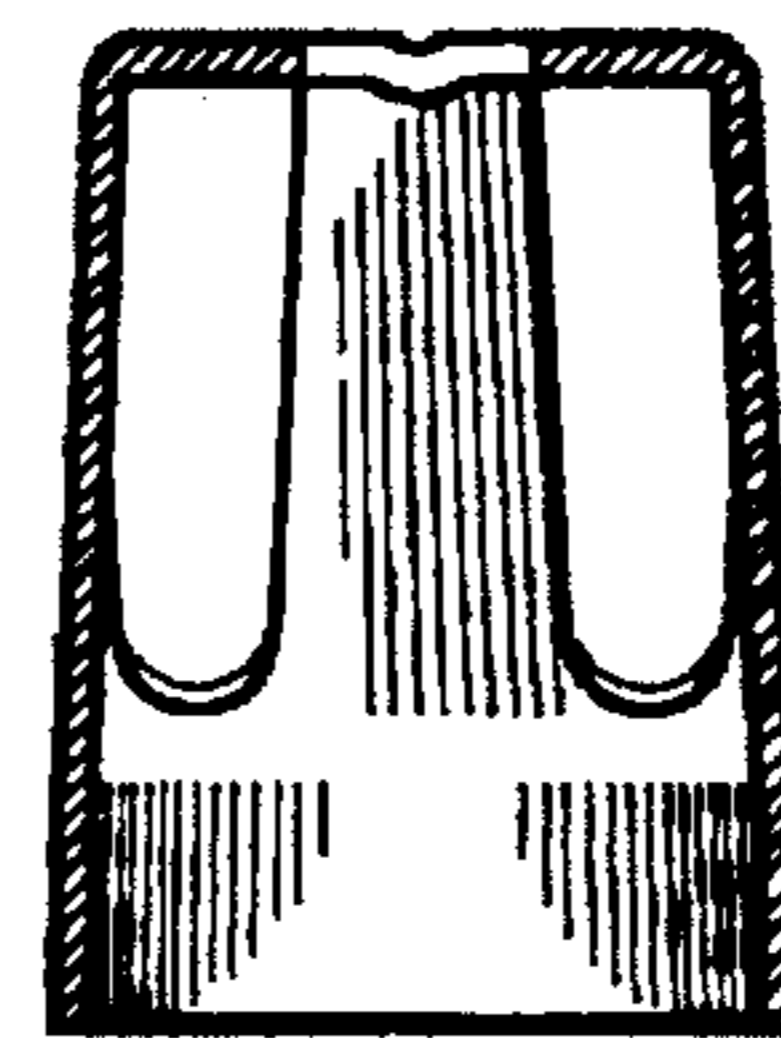

FIG. 8

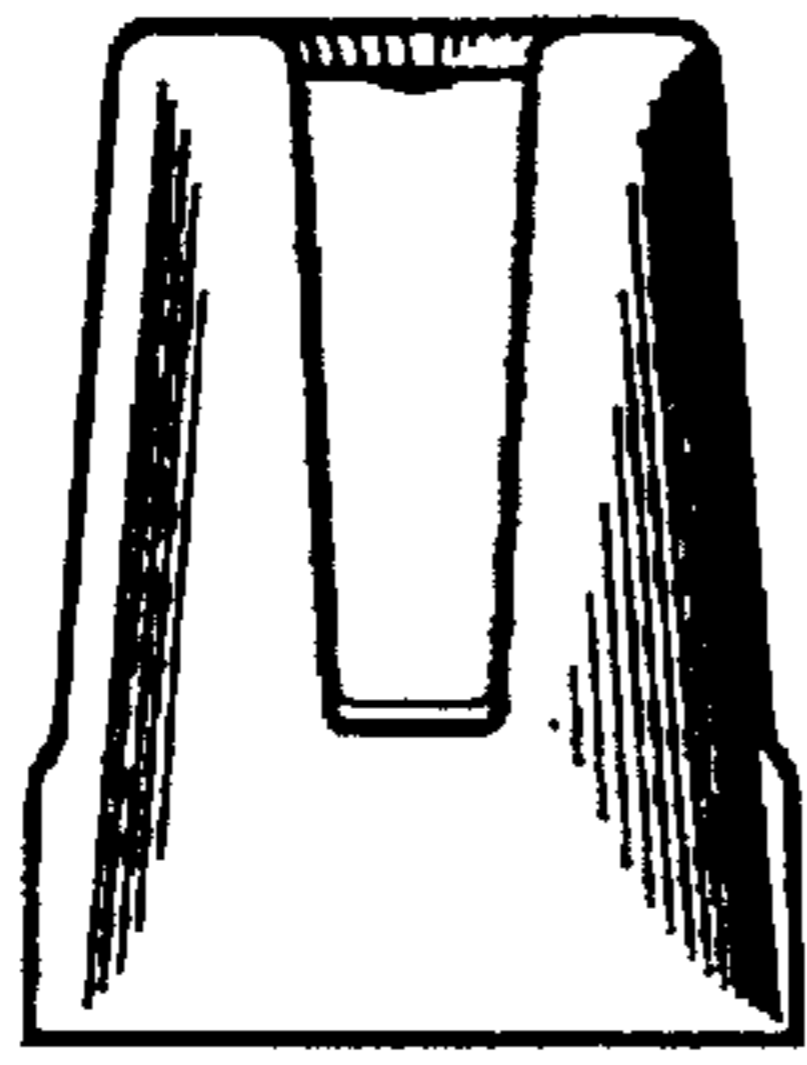

FIG. 9

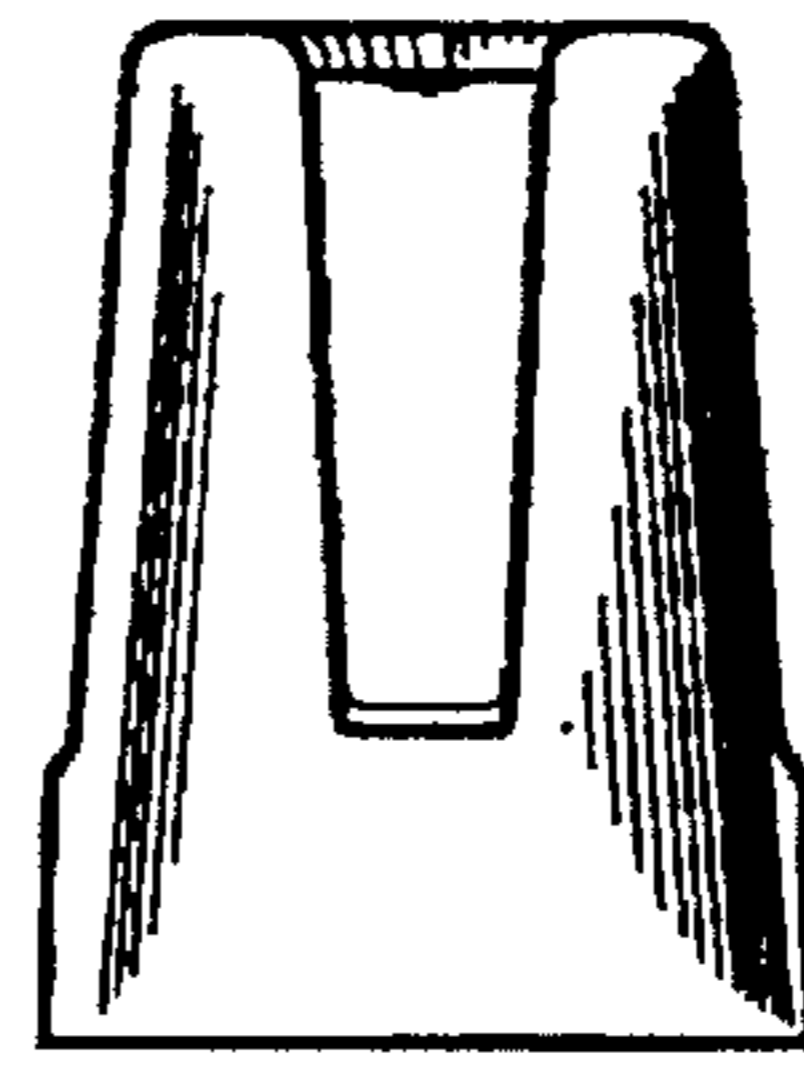

FIG. 10

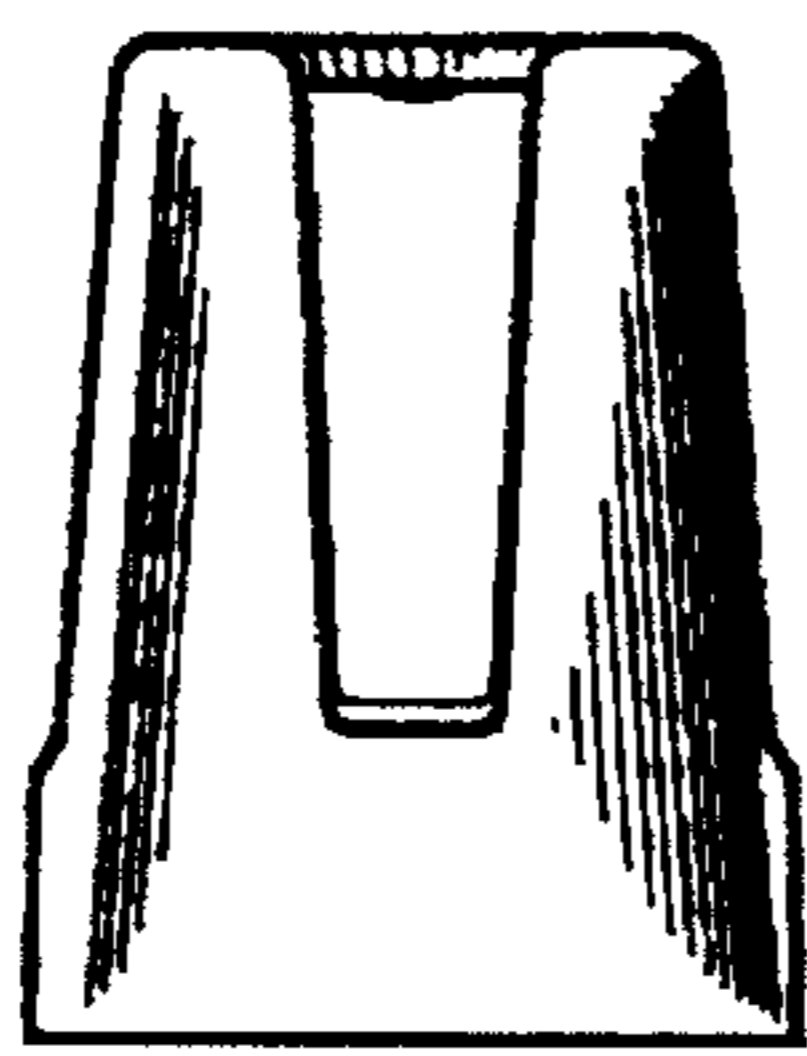

FIG. 11

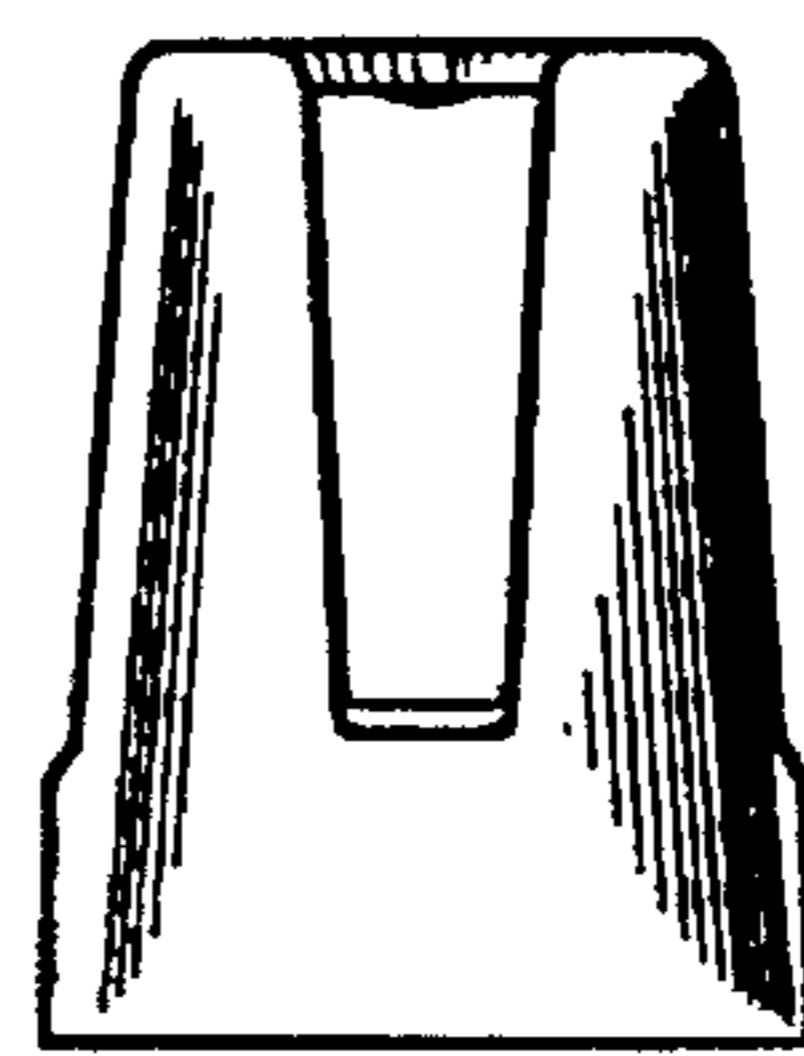

FIG. 12

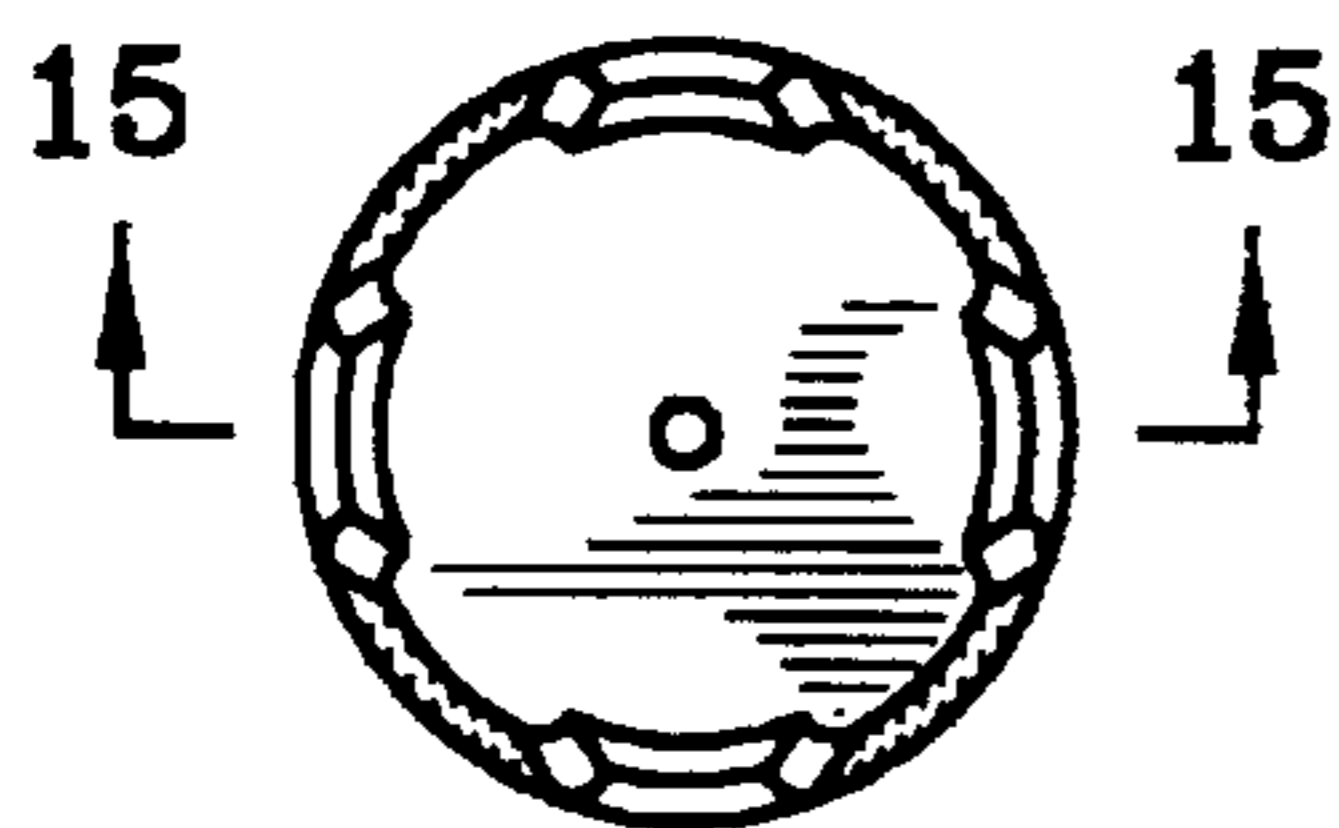

FIG. 13

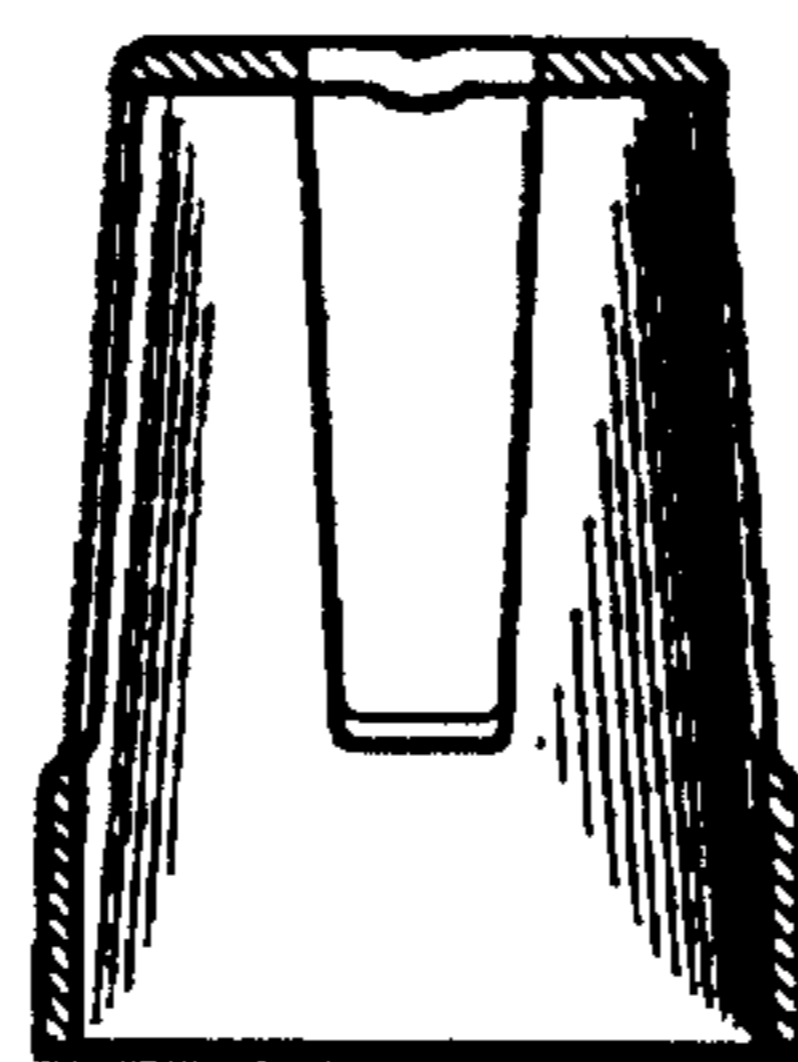

FIG. 15

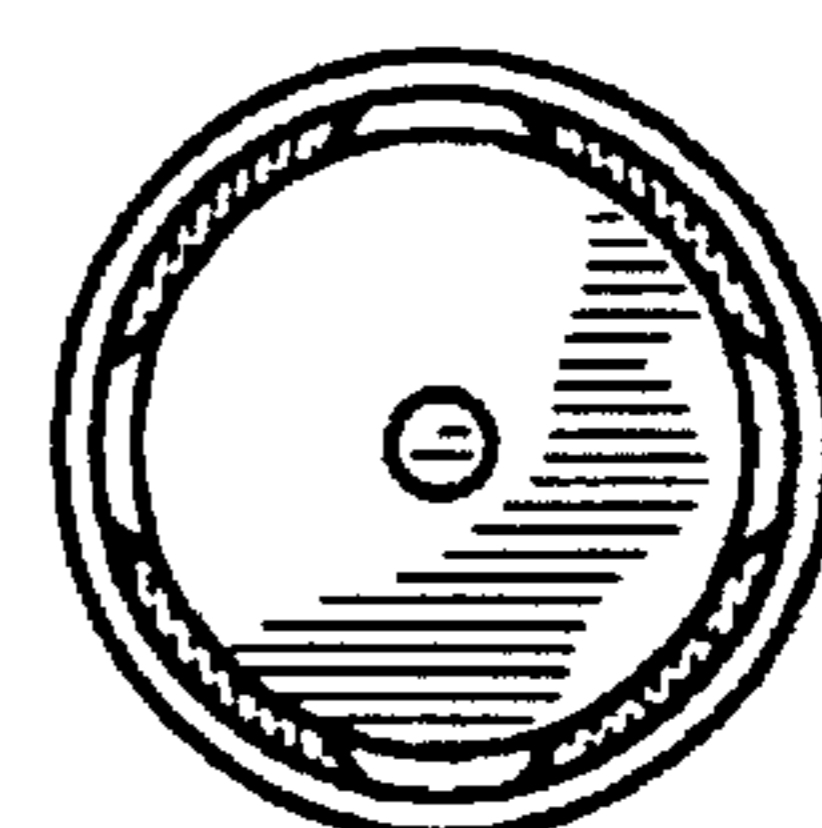

FIG. 14

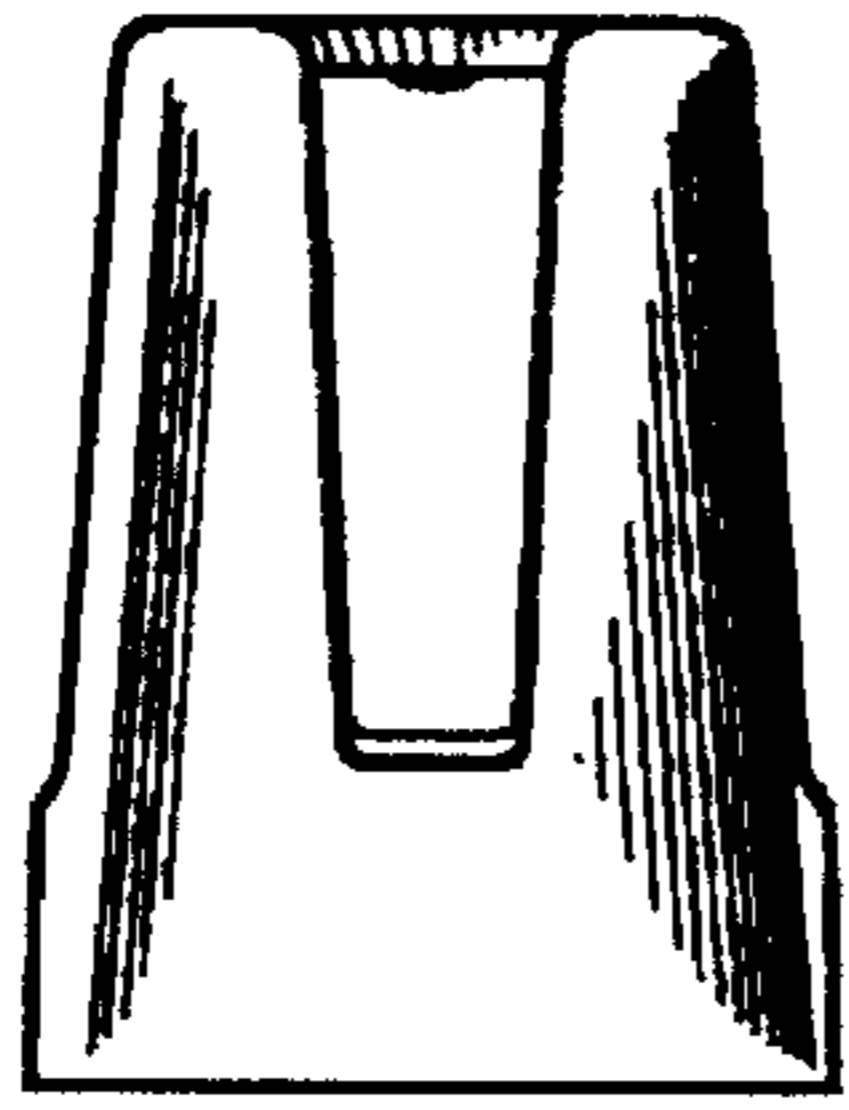

FIG. 16

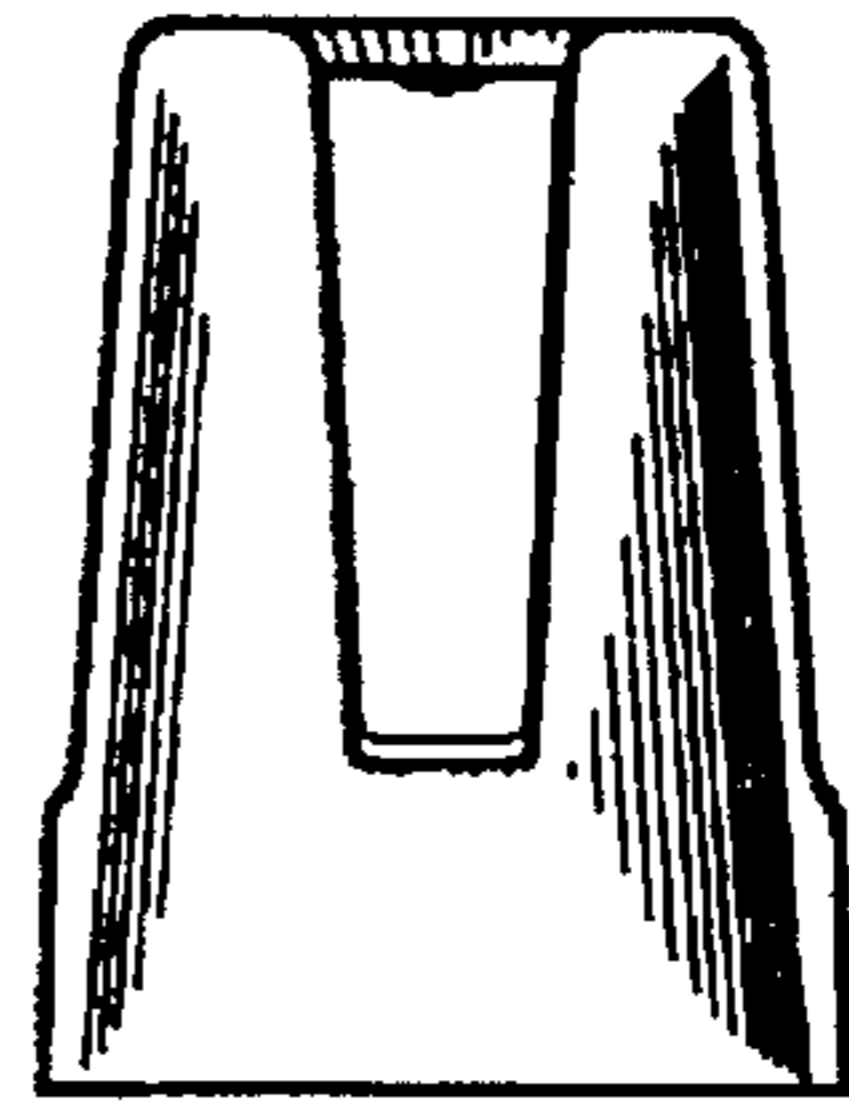

FIG. 17

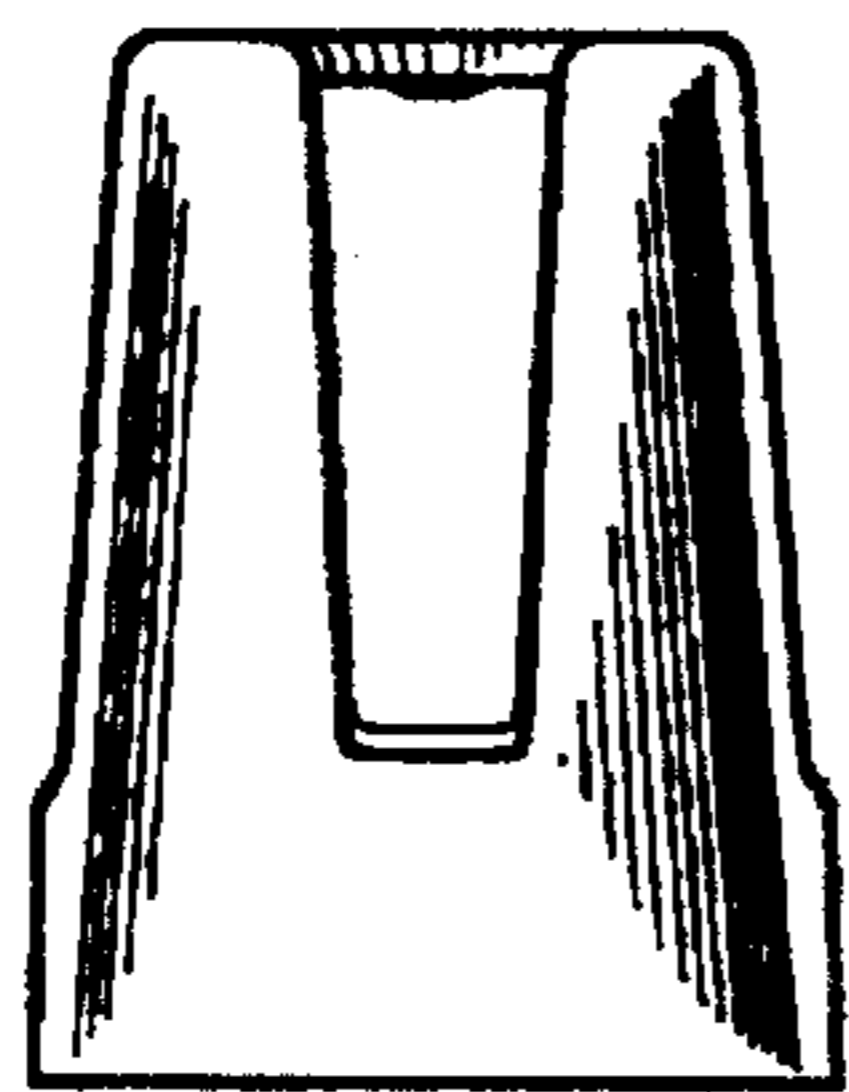

FIG. 18

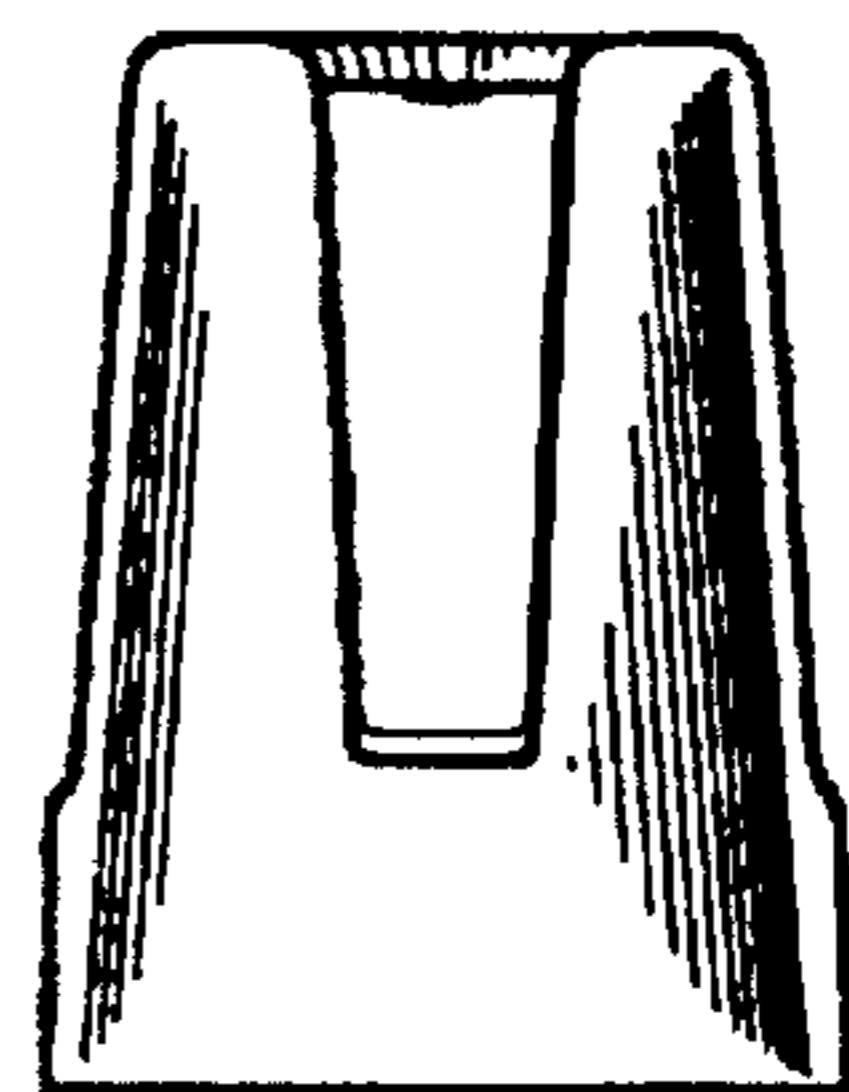

FIG. 19

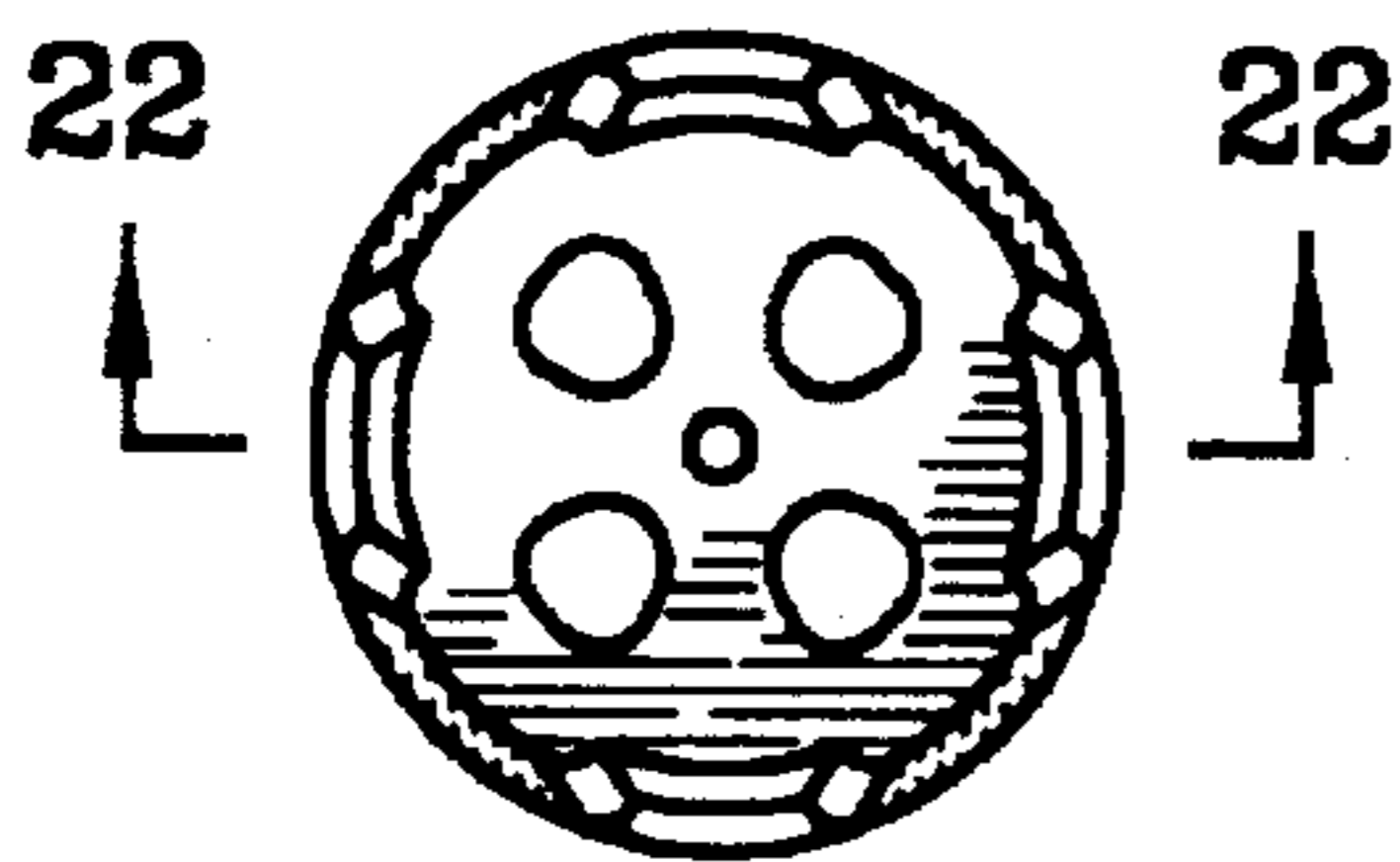

FIG. 20

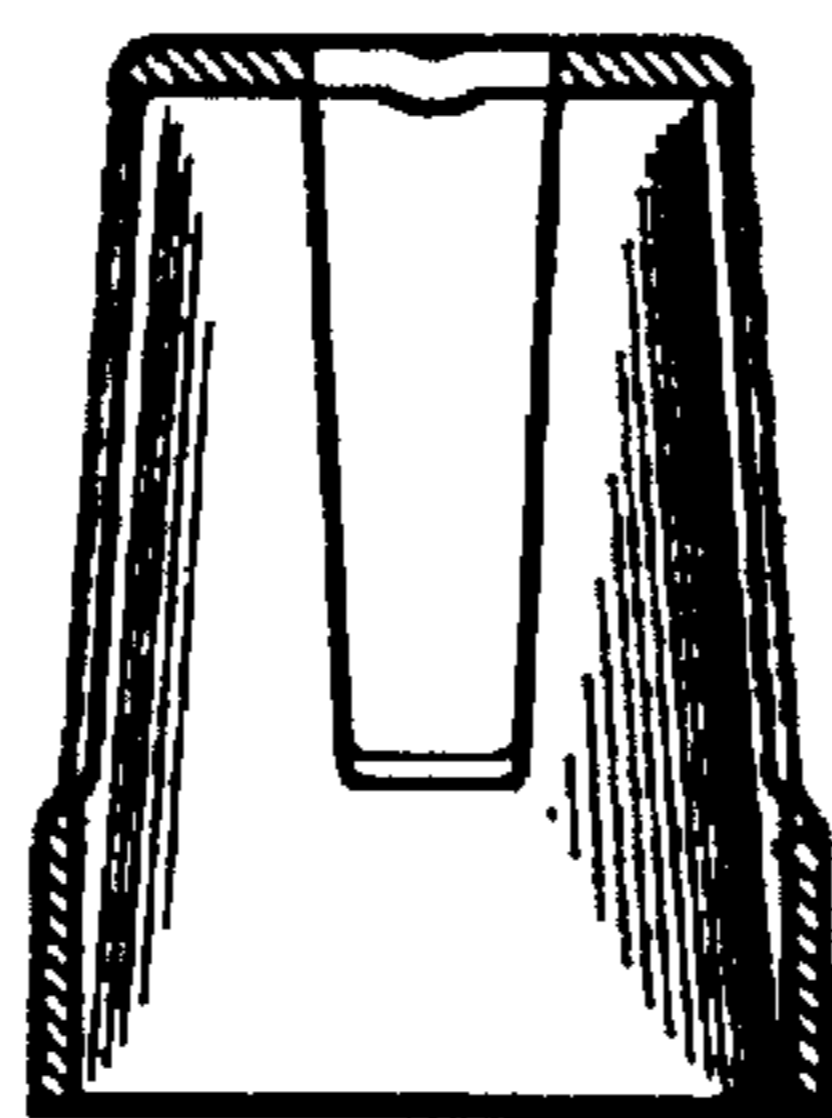

FIG. 22

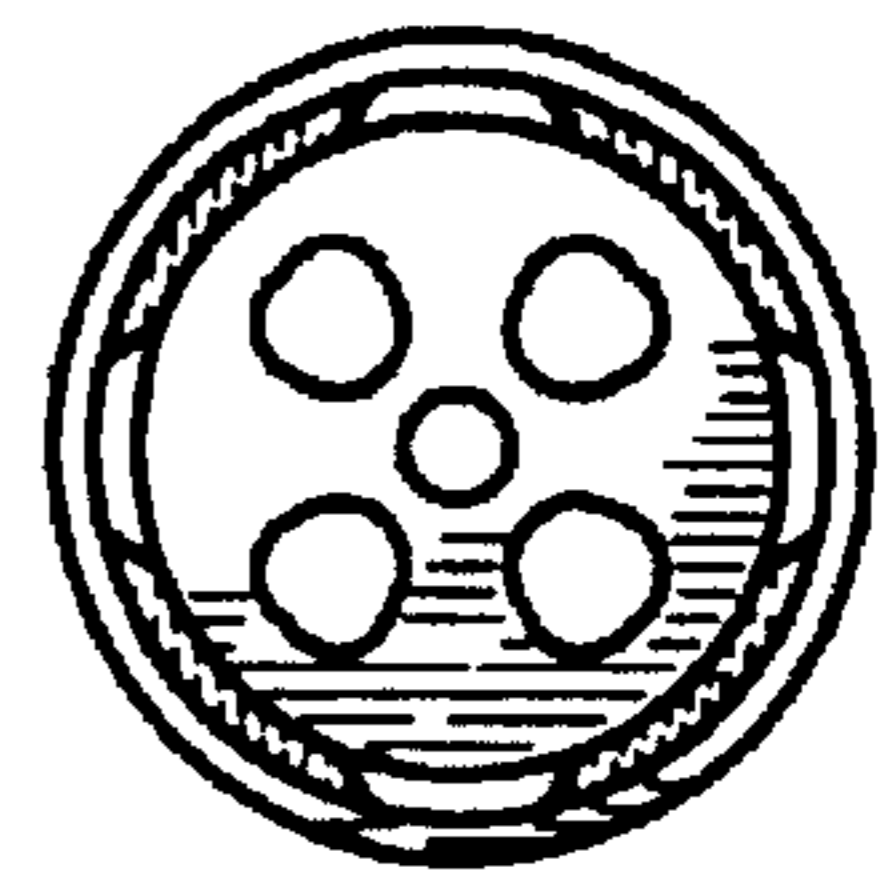

FIG. 21

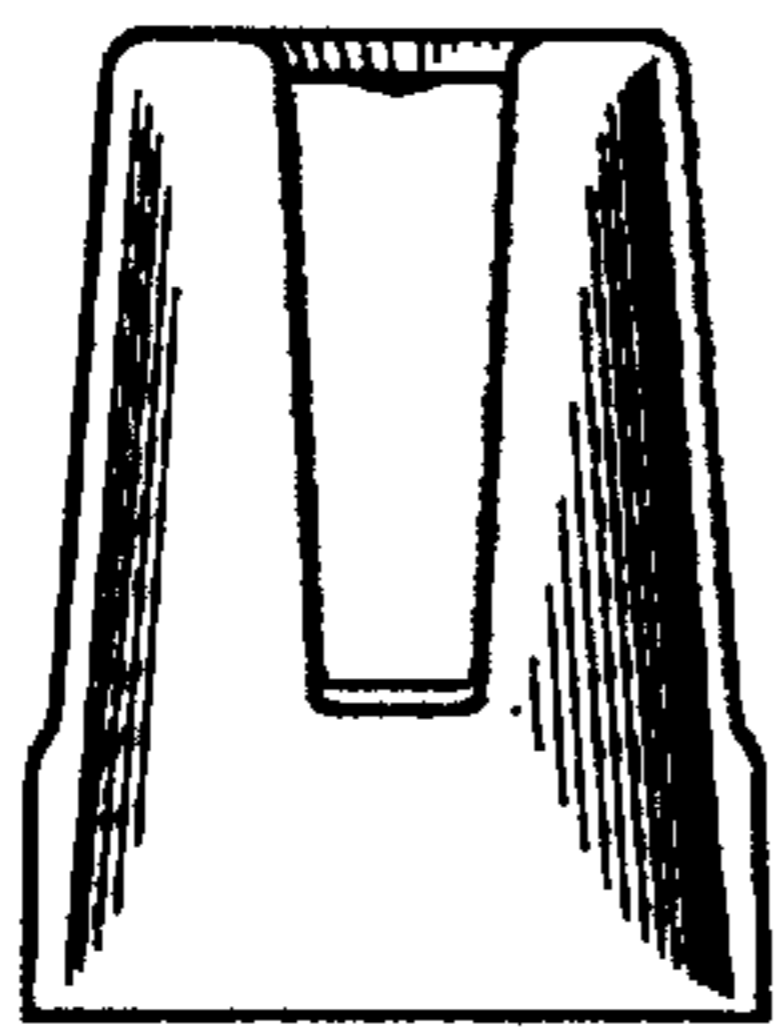

FIG. 23

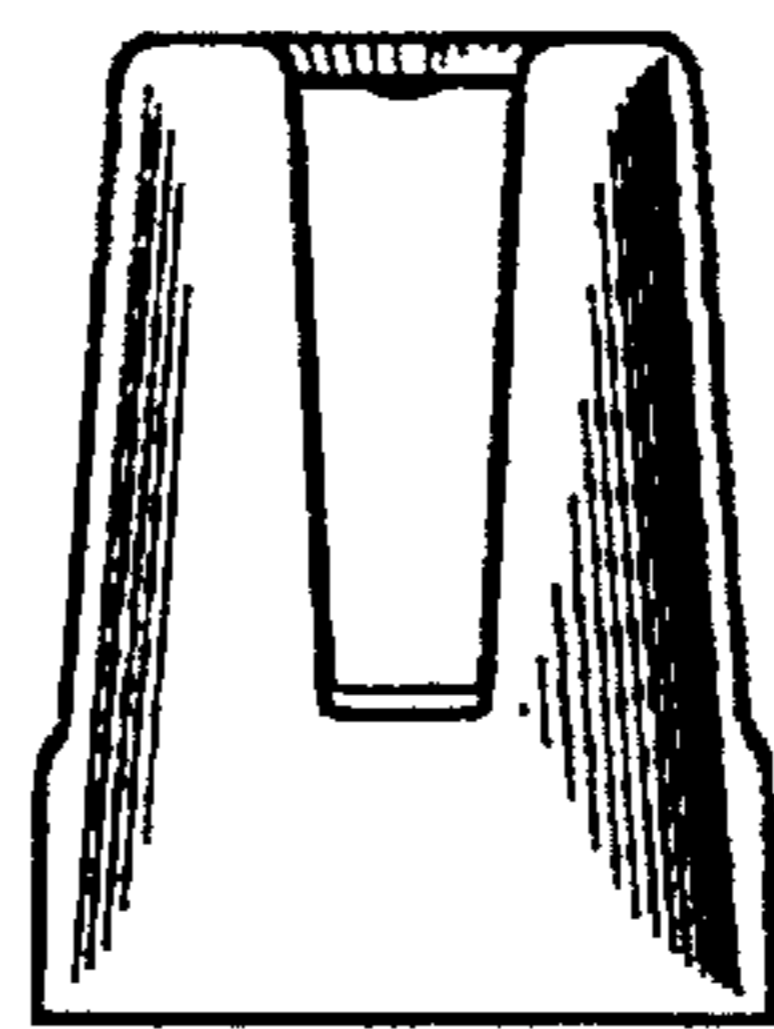

FIG. 24

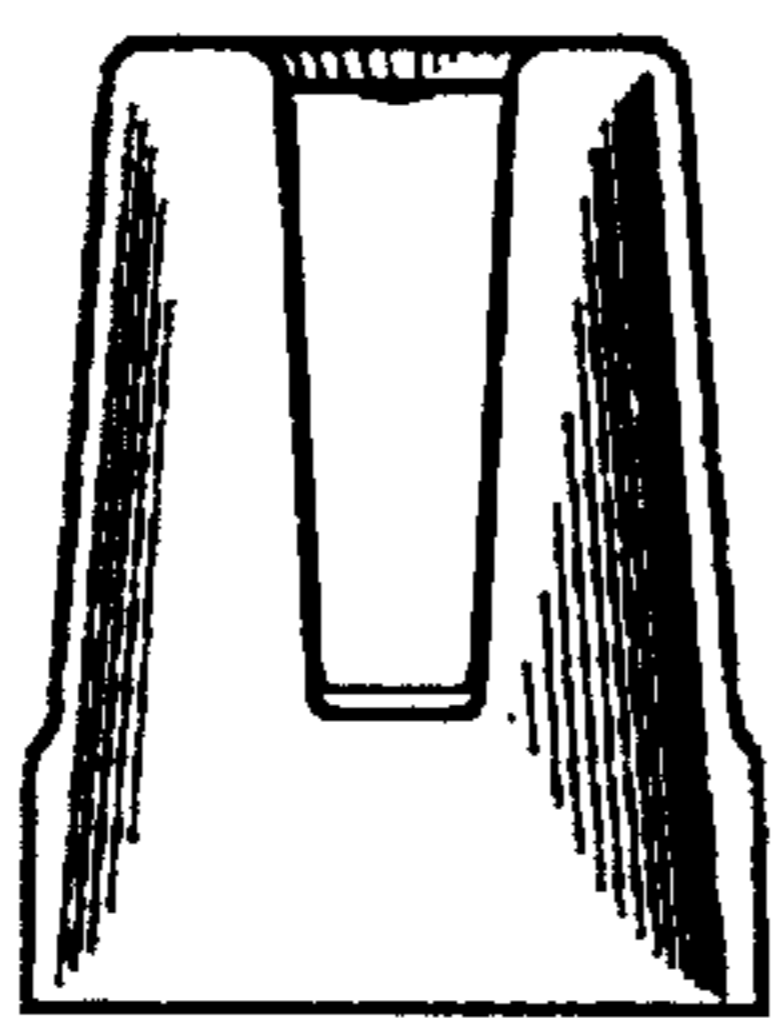

FIG. 25

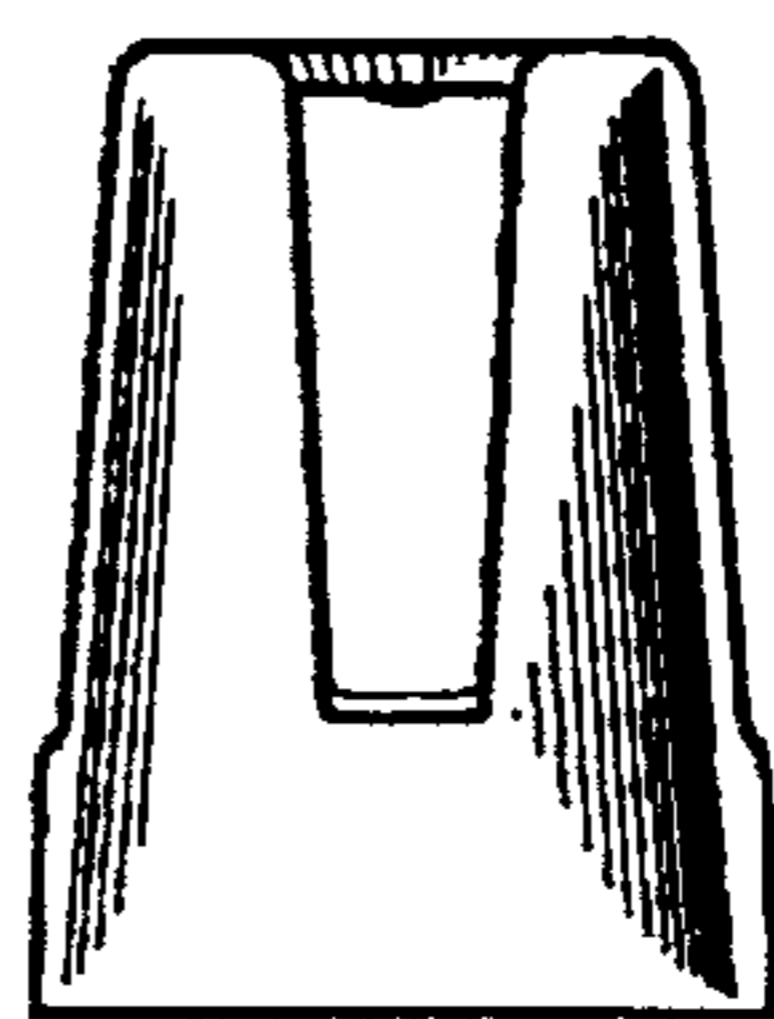

FIG. 26

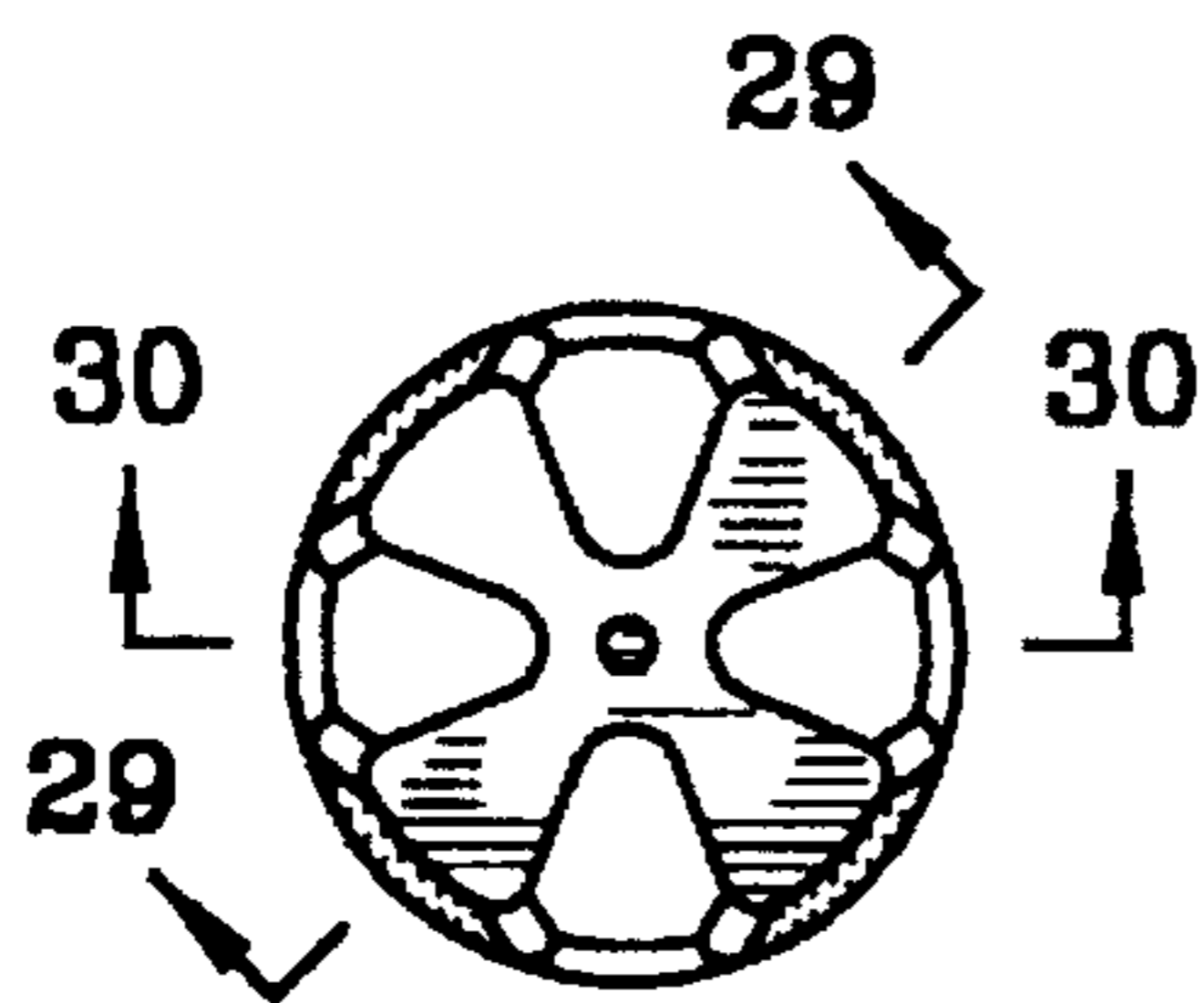

FIG. 27

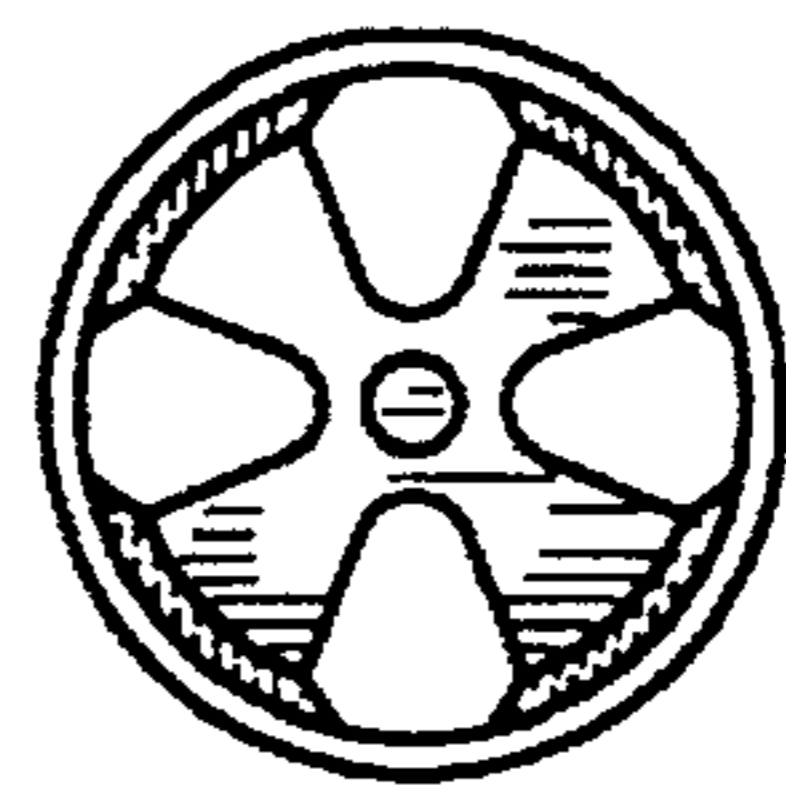

FIG. 28

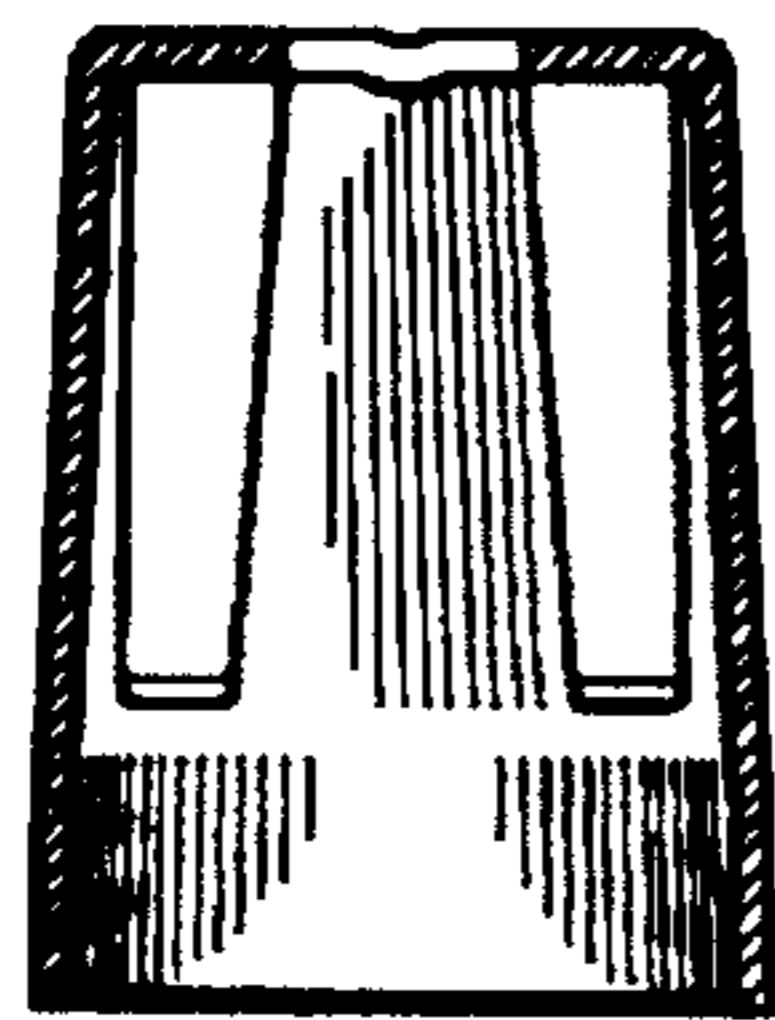

FIG. 29

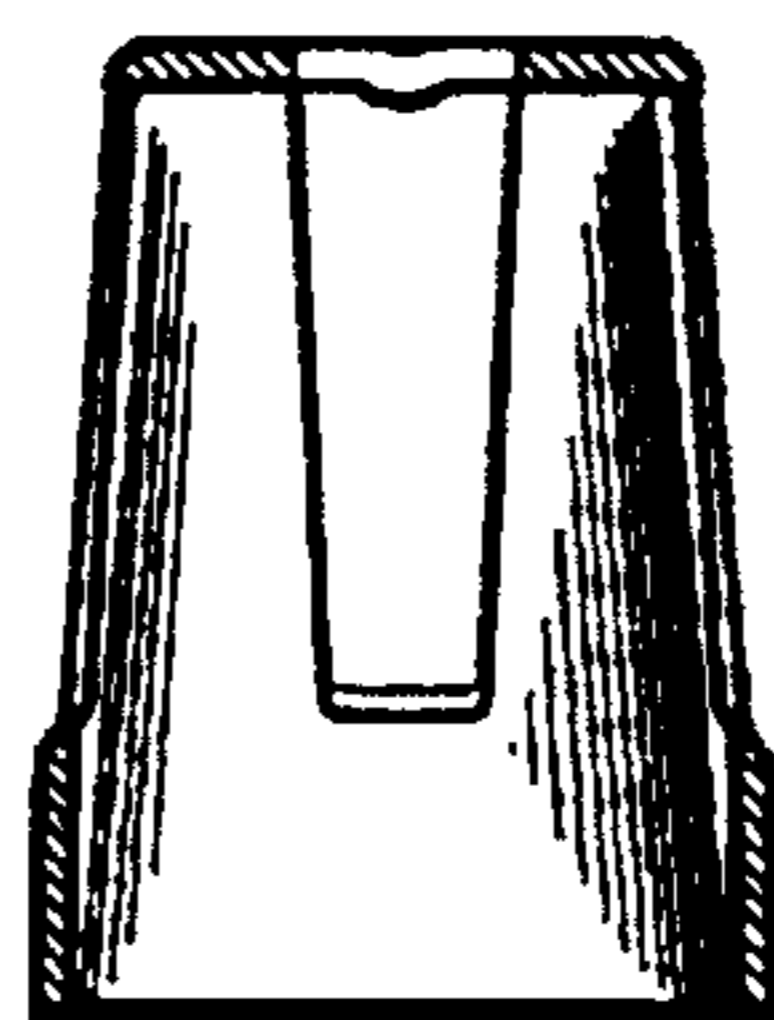

FIG. 30

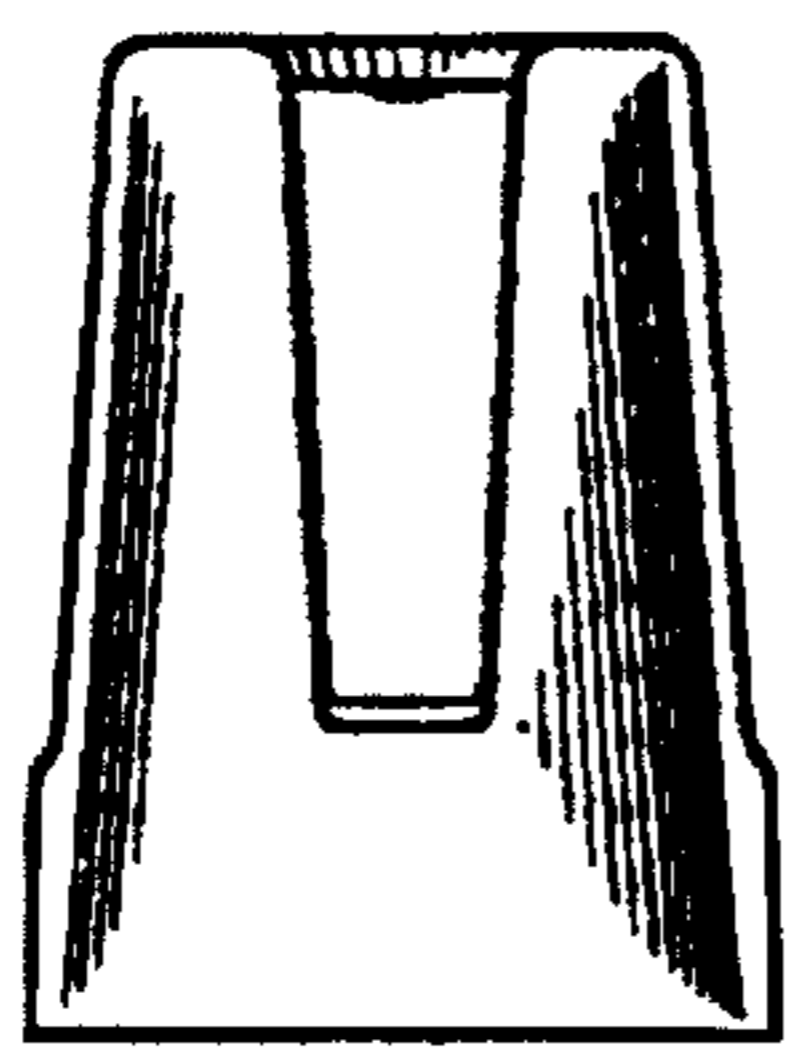

FIG. 31

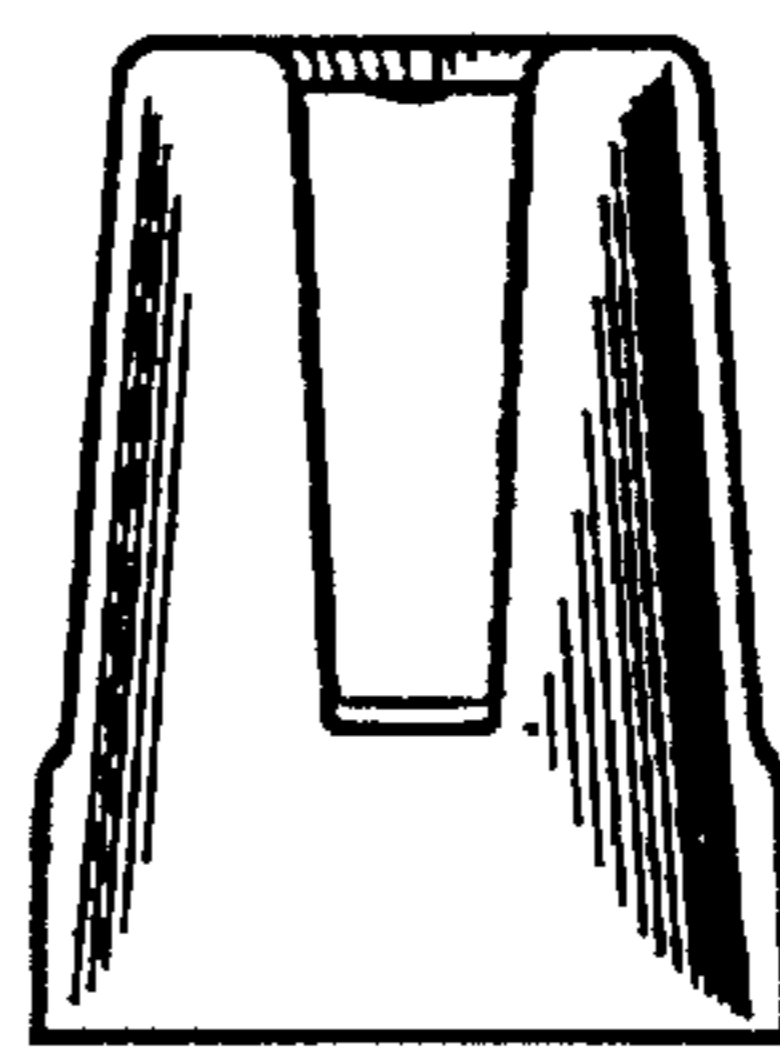

FIG. 32

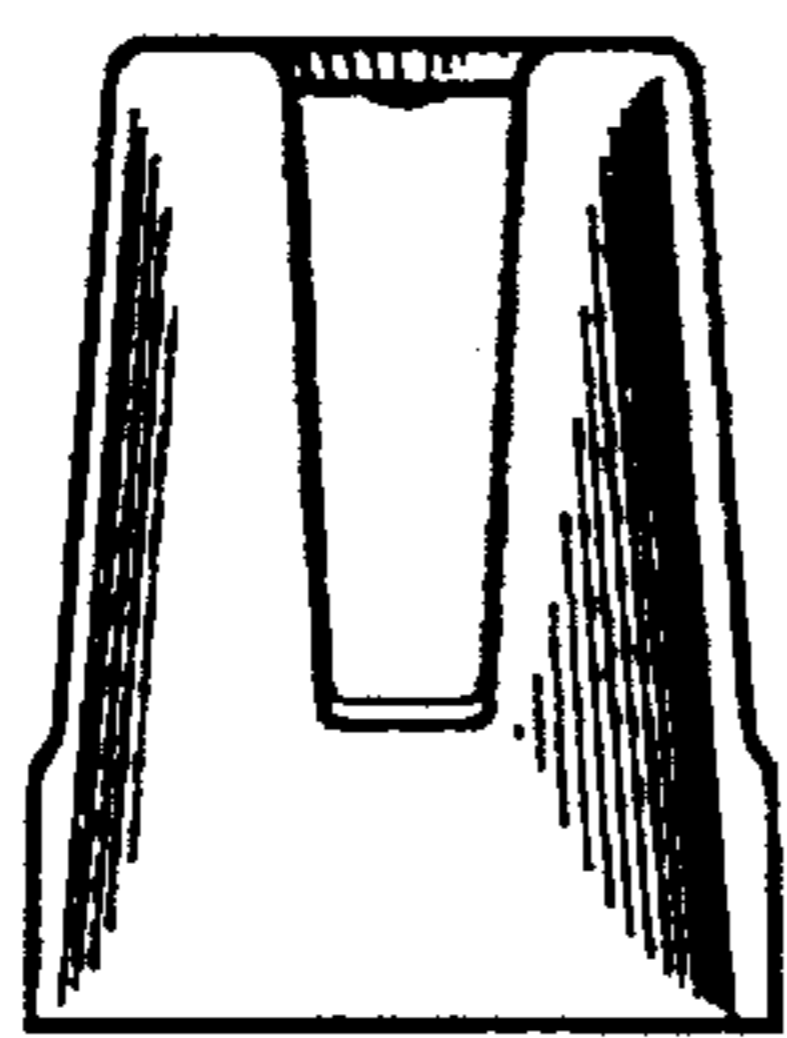

FIG. 33

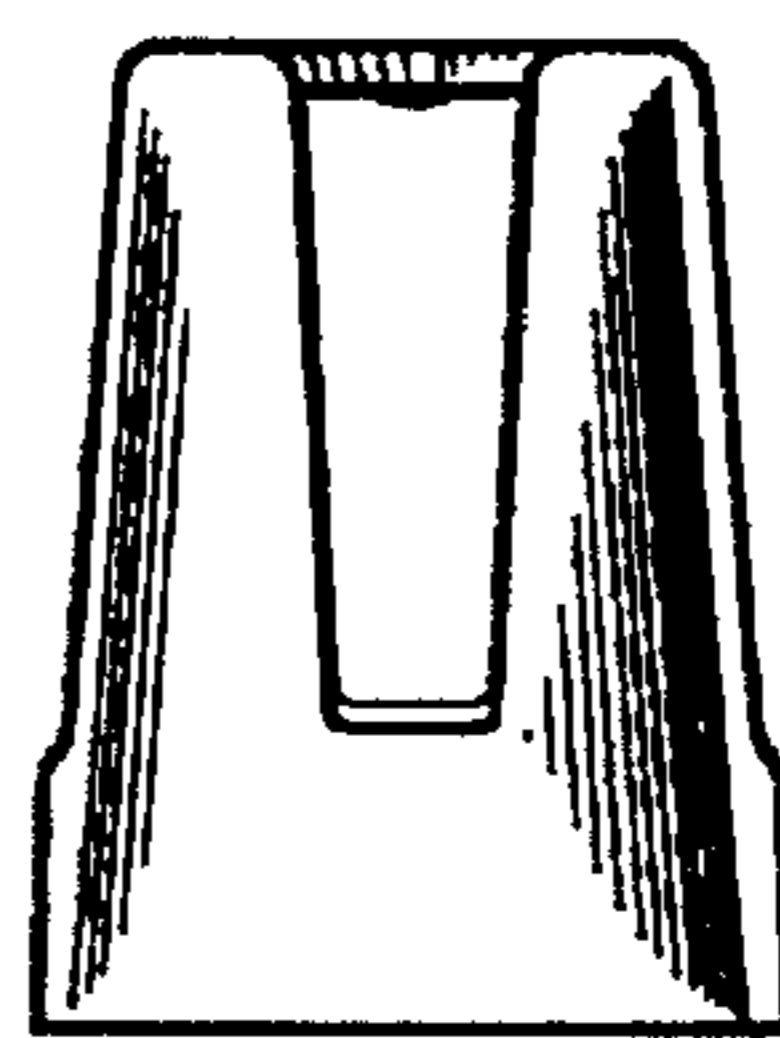

FIG. 34

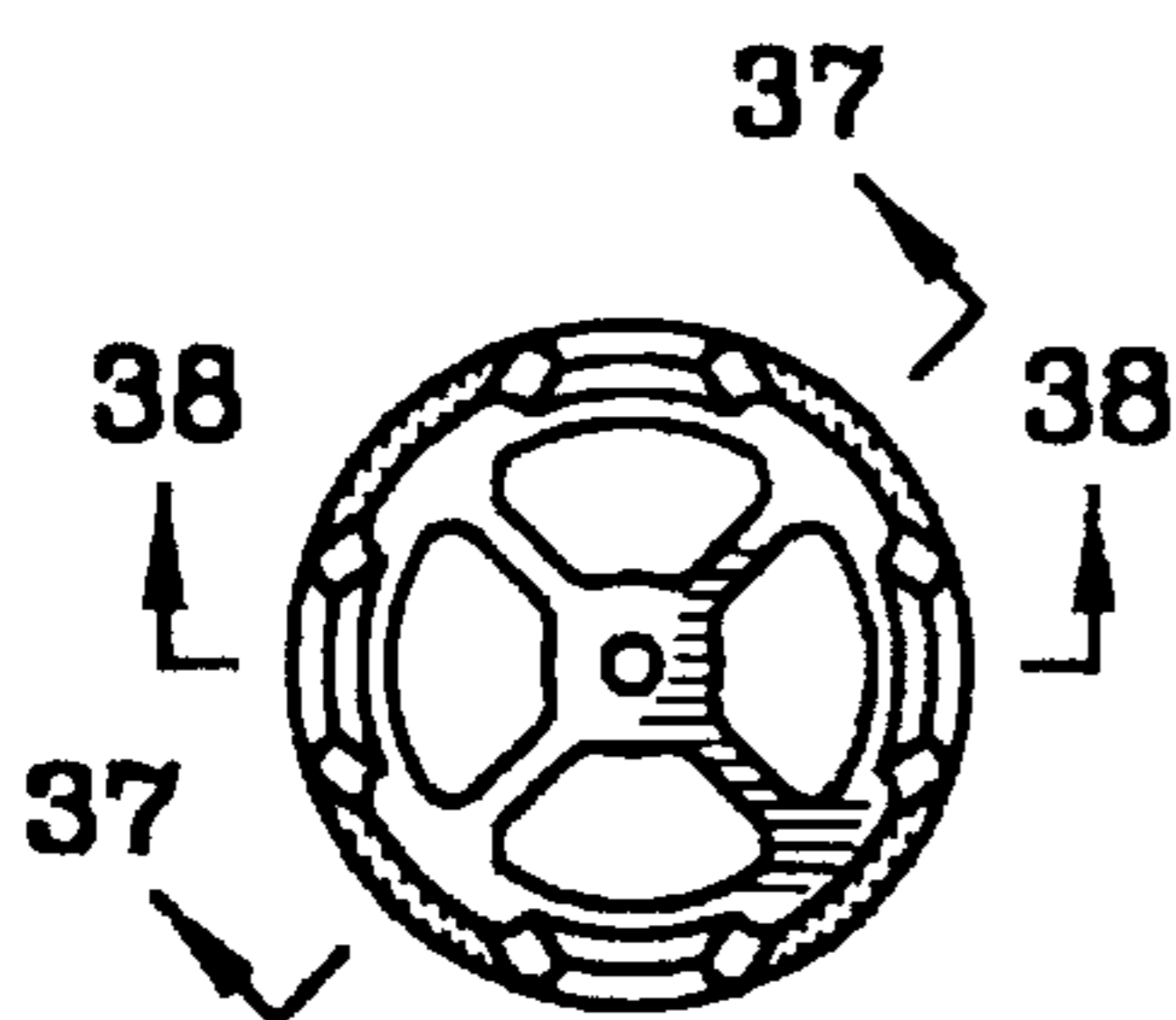

FIG. 35

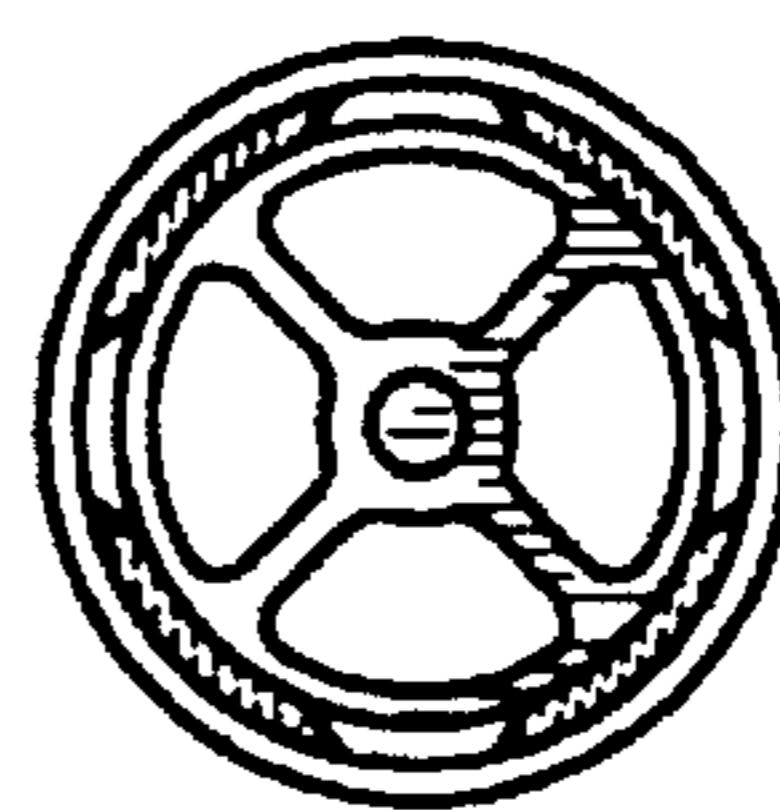

FIG. 36

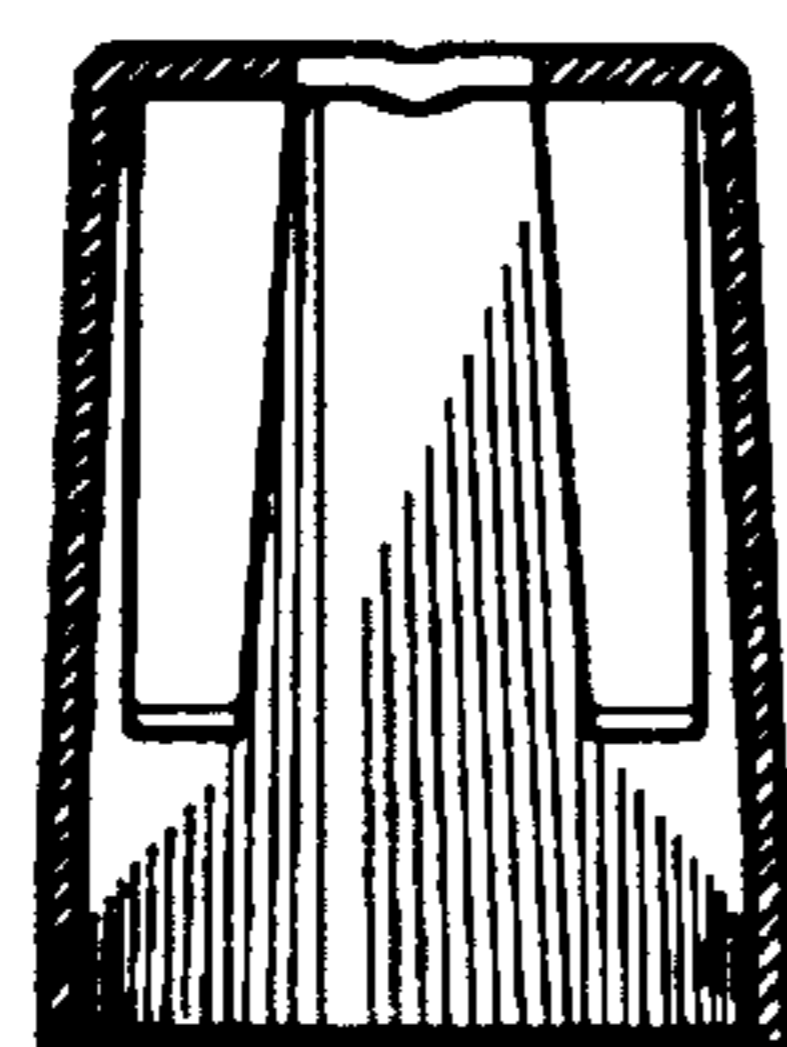

FIG. 37

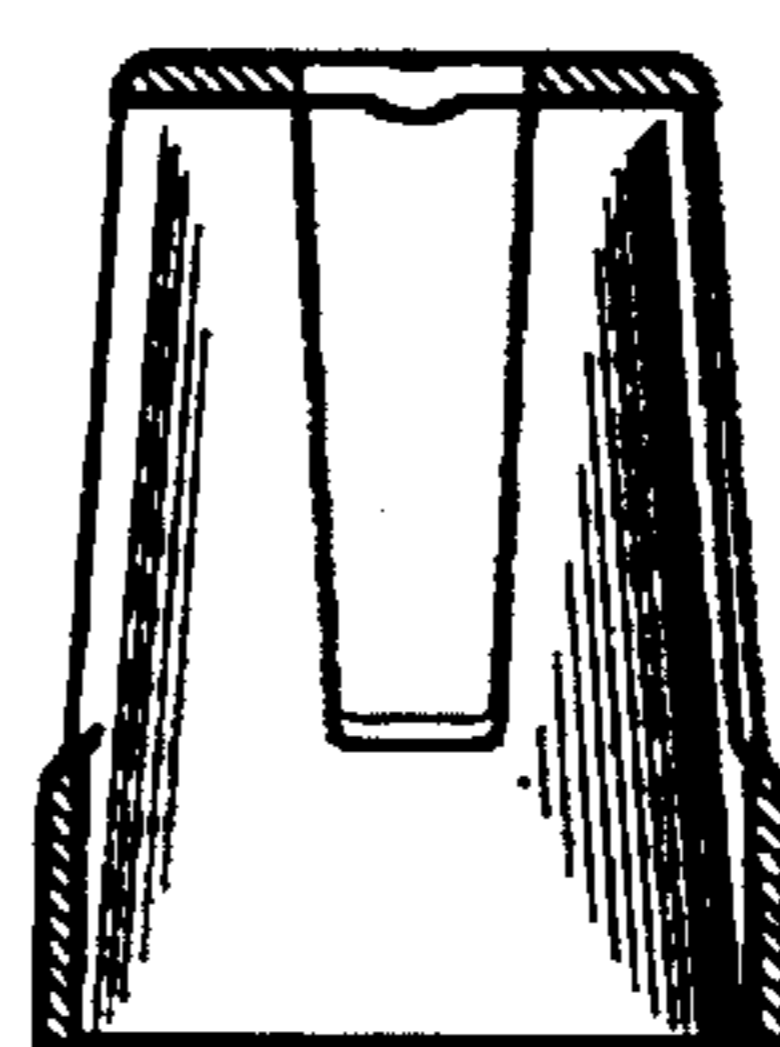

FIG. 38