



US00D382772S

# United States Patent [19] Mogil

[11] Patent Number: Des. 382,772

[45] Date of Patent: \*\*Aug. 26, 1997

[54] **PORTABLE COOLER CONTAINER**

[75] Inventor: **Melvin S. Mogil**, Toronto, Canada

[73] Assignee: **California Innovations Inc.**,  
Willowdale, Canada

[\*\*] Term: **14 Years**

[21] Appl. No.: **55,463**

[22] Filed: **Jun. 5, 1996**

[51] LOC (6) Cl. .... **07-07**

[52] U.S. Cl. .... **D7/607**

[58] **Field of Search** ..... D7/605-607; D3/201,  
D3/273, 276, 283, 268, 301; 62/457.1,  
457.7, 371; 150/107, 118, 119; 206/545,  
549, 541, 548; 220/410, 412; 383/2, 14,  
17, 18, 95, 97, 109, 110, 113

[56] **References Cited**

**U.S. PATENT DOCUMENTS**

D. 328,550	8/1992	Mogil et al.	.....	D7/605
D. 340,387	10/1993	Melk	.....	D7/607
D. 340,621	10/1993	Melk	.....	D7/607
D. 340,840	11/1993	Melk	.....	D7/607
5,354,131	10/1994	Mogil	.....	383/110 X
5,403,095	4/1995	Melk	.....	383/110
5,472,279	12/1995	Lin	.....	383/110 X
5,526,907	6/1996	Trawick et al.	.....	383/110 X

*Primary Examiner*—Terry A. Wallace

*Attorney, Agent, or Firm*—Nikaido, Marmelstein, Murray & Oram LLP

[57] **CLAIM**

The ornamental design for a portable cooler container, as shown and described.

**DESCRIPTION**

FIG. 1 is a top perspective view of a portable cooler container showing my new design;  
 FIG. 2 is a front elevation view thereof;  
 FIG. 3 is a left side elevation view thereof;  
 FIG. 4 is a right side elevation view thereof;  
 FIG. 5 is a rear elevation view thereof;  
 FIG. 6 is a bottom plan view thereof;  
 FIG. 7 is a top plan view thereof;  
 FIG. 8 is a top perspective view thereof in an alternate position;  
 FIG. 9 is a front elevation view of FIG. 8;  
 FIG. 10 is a left side elevation view of FIG. 8;  
 FIG. 11 is a right side elevation view of FIG. 8;  
 FIG. 12 is a rear elevation view of FIG. 8;  
 FIG. 13 is a bottom plan view of FIG. 8;  
 FIG. 14 is a top plan view of FIG. 8;  
 FIG. 15 is a perspective view thereof in an alternate position;  
 and,  
 FIG. 16 is a right side elevation view of FIG. 15.

**1 Claim, 5 Drawing Sheets**

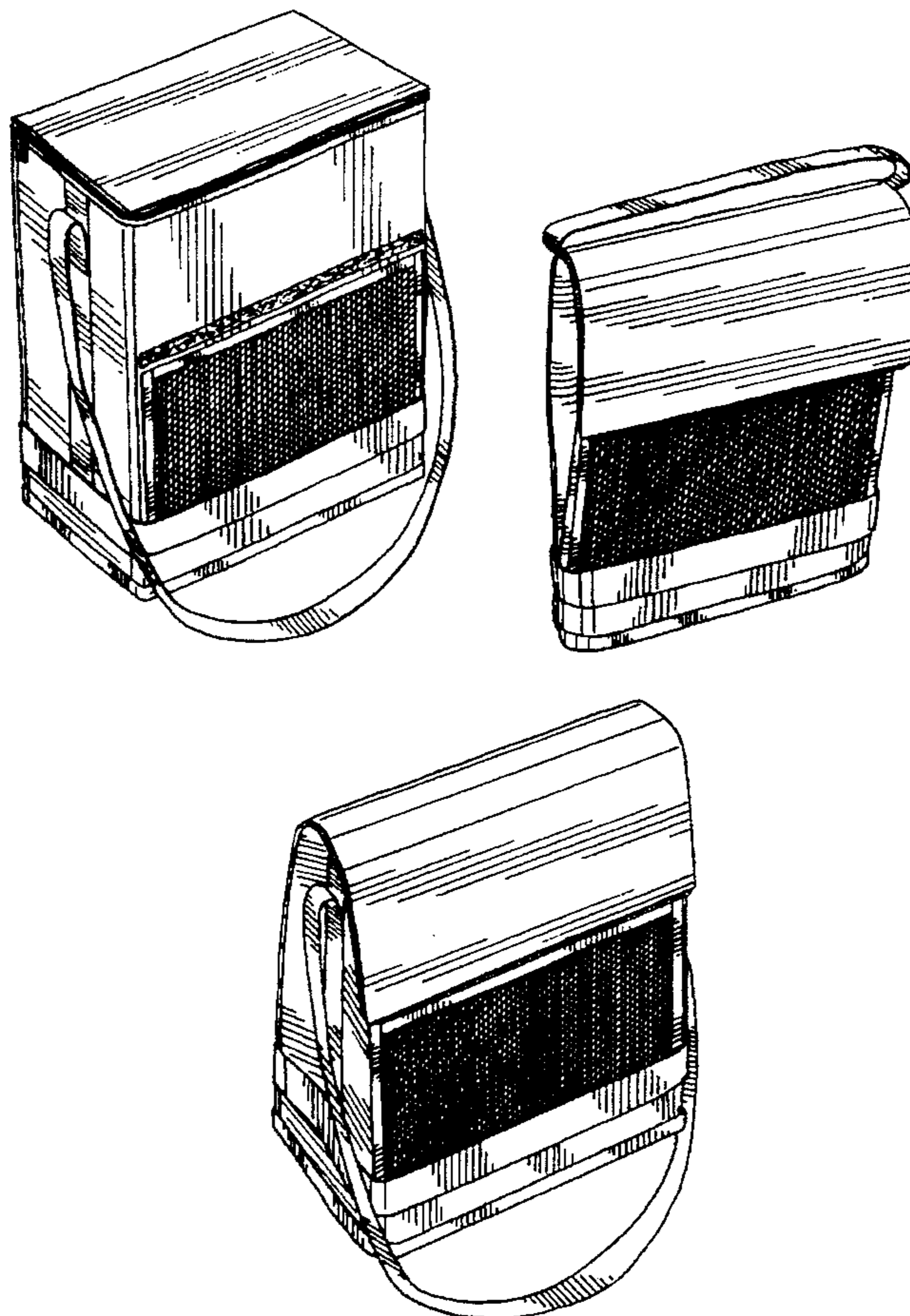

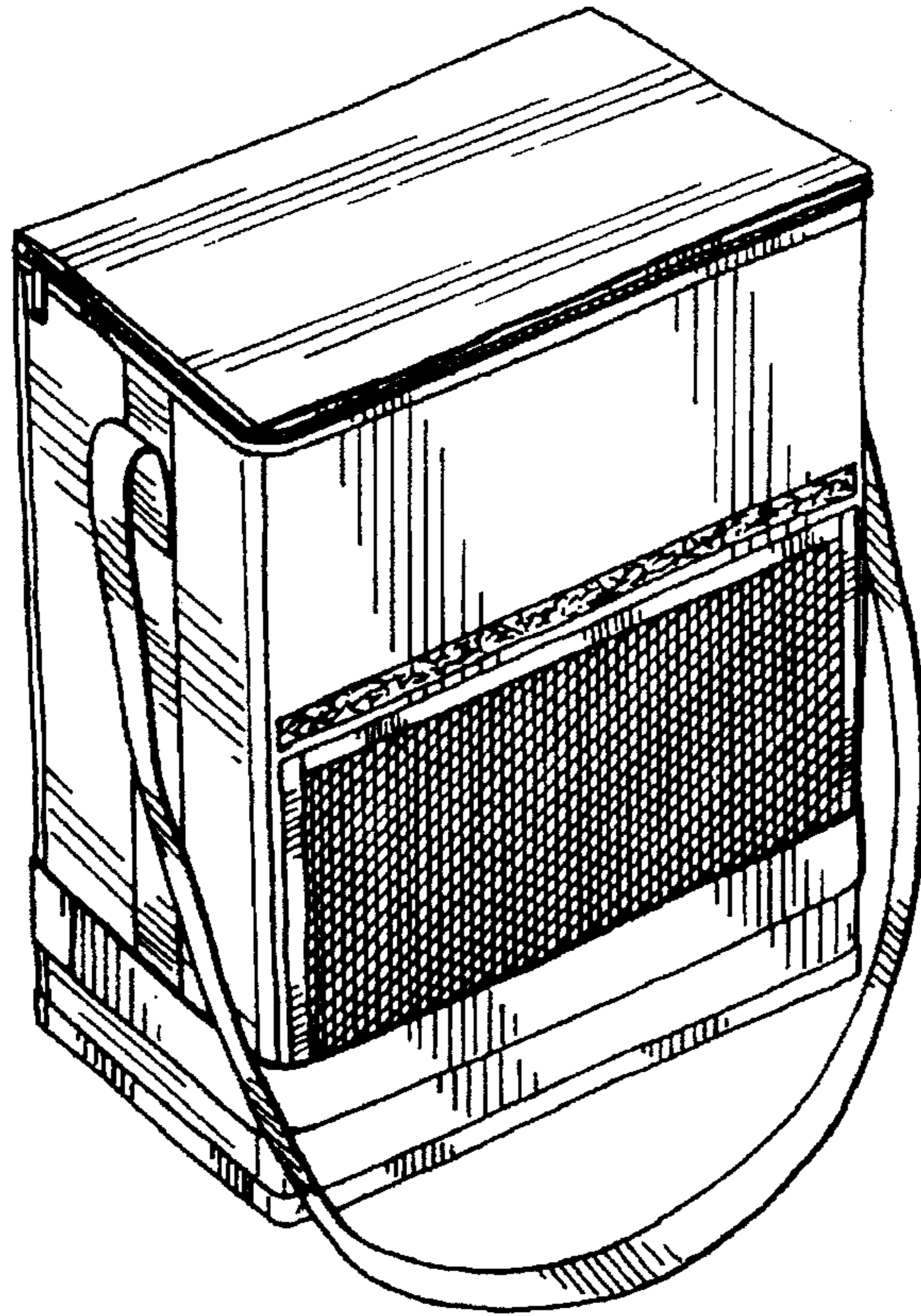

FIG. 1

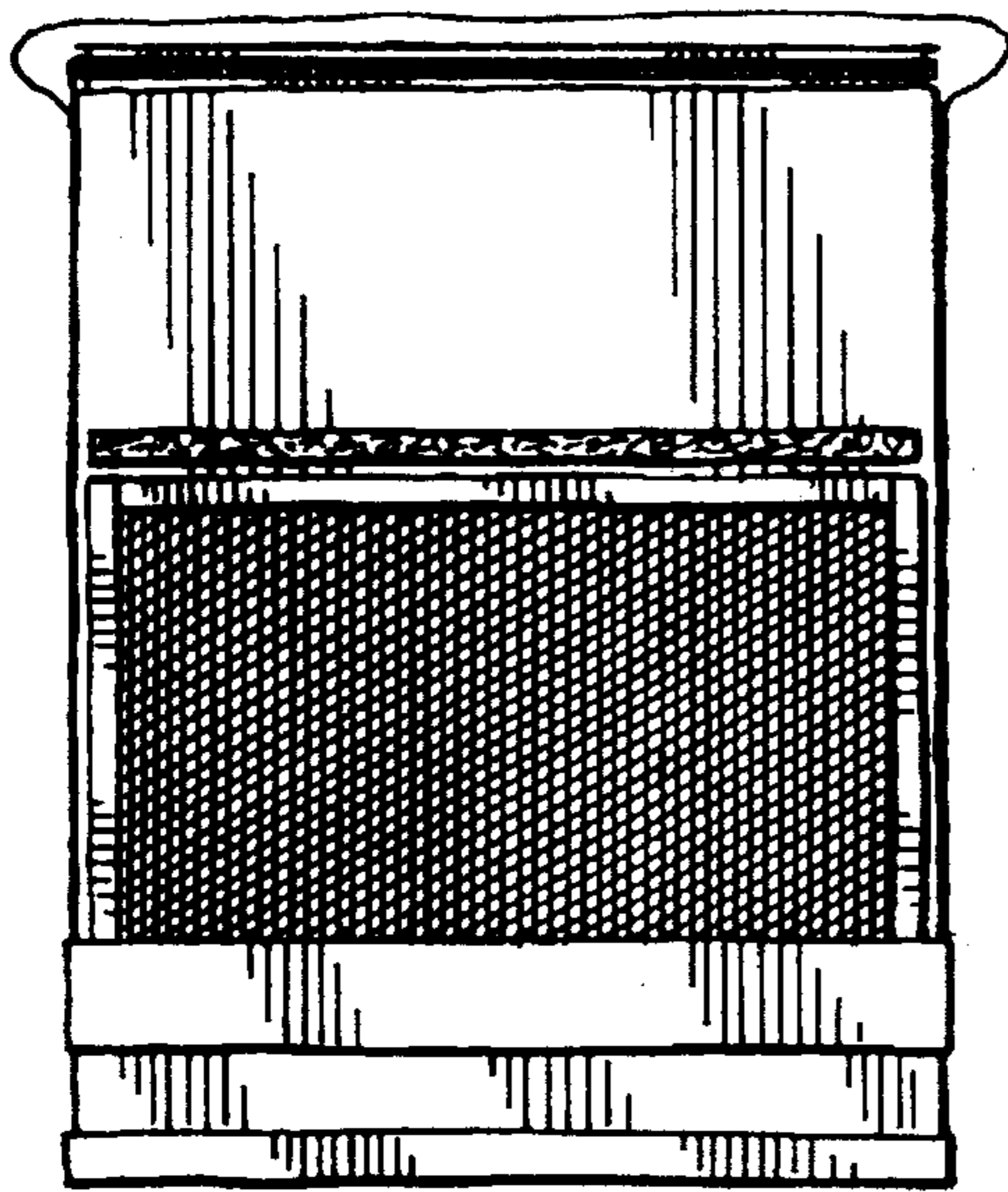

FIG. 2

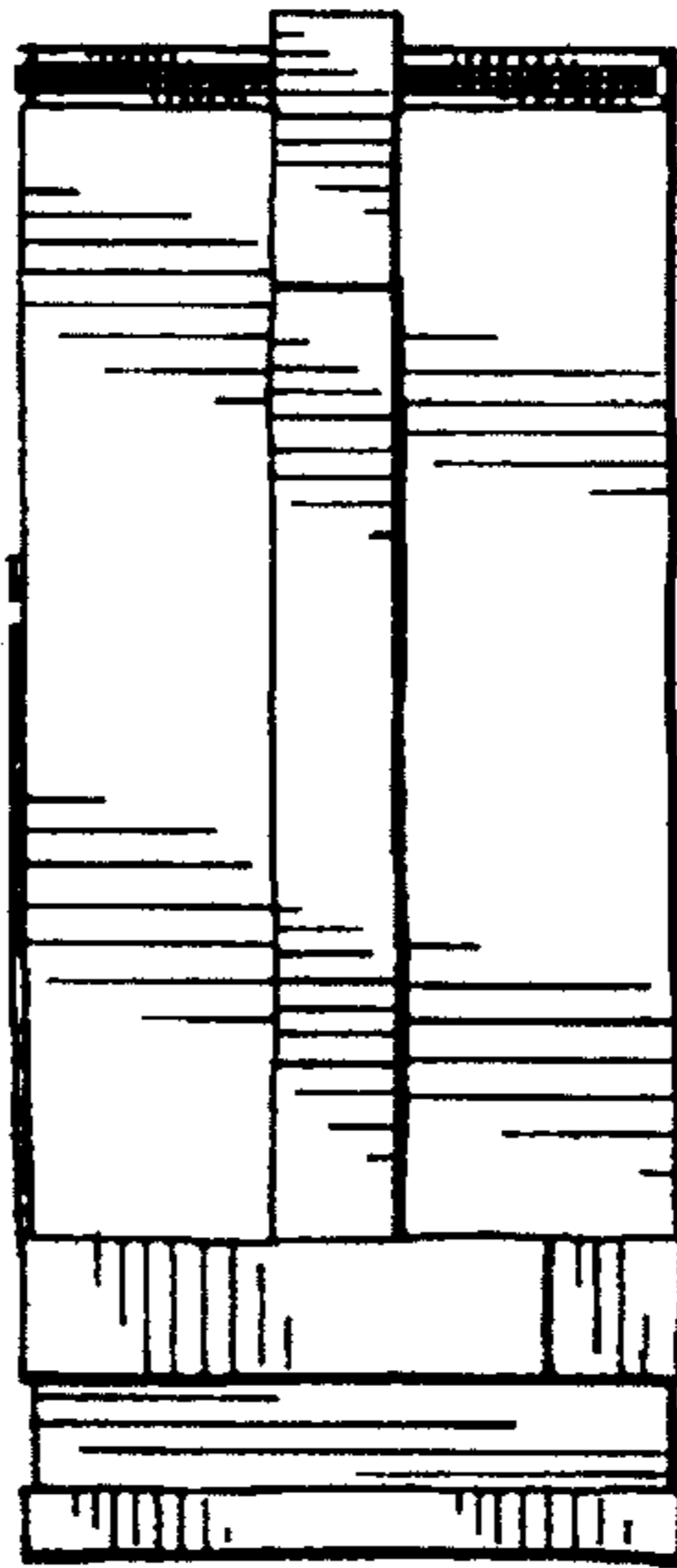

FIG. 3

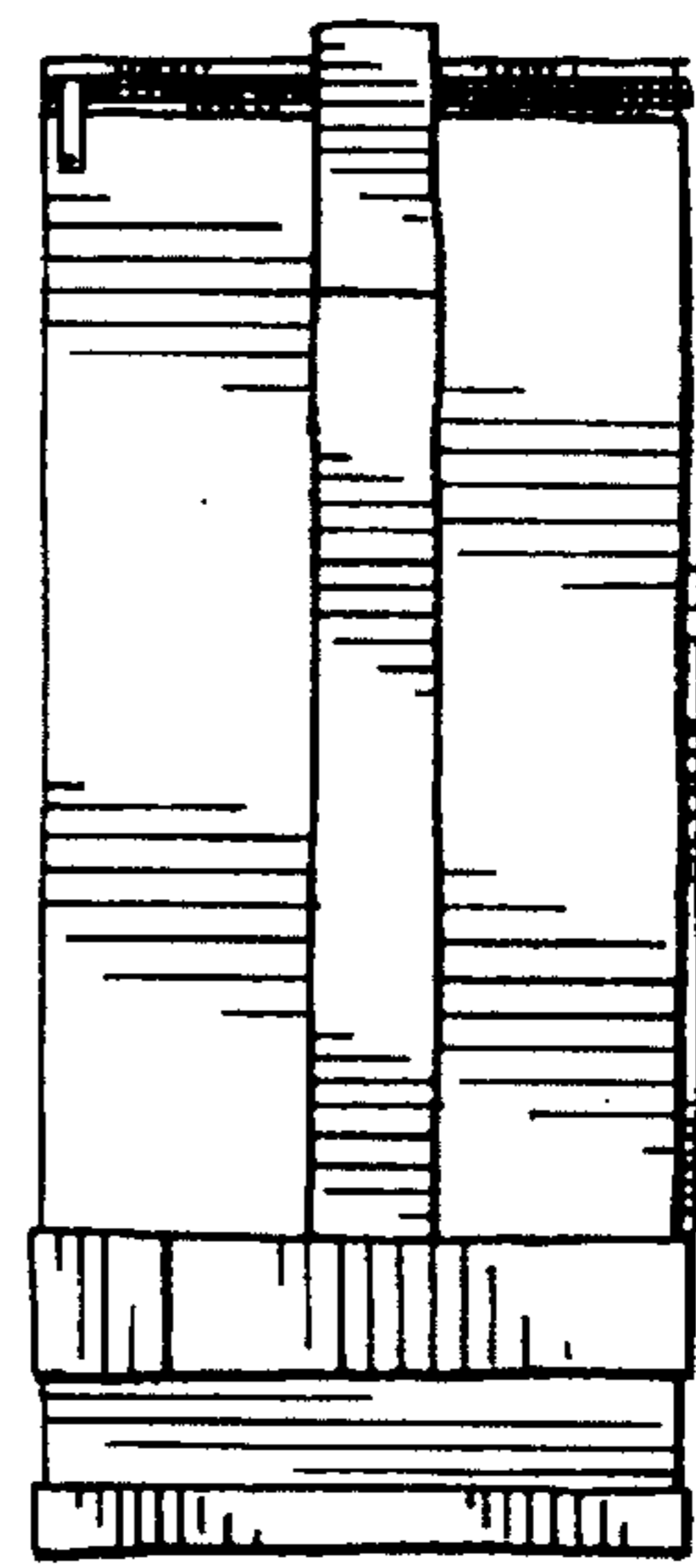

FIG. 4

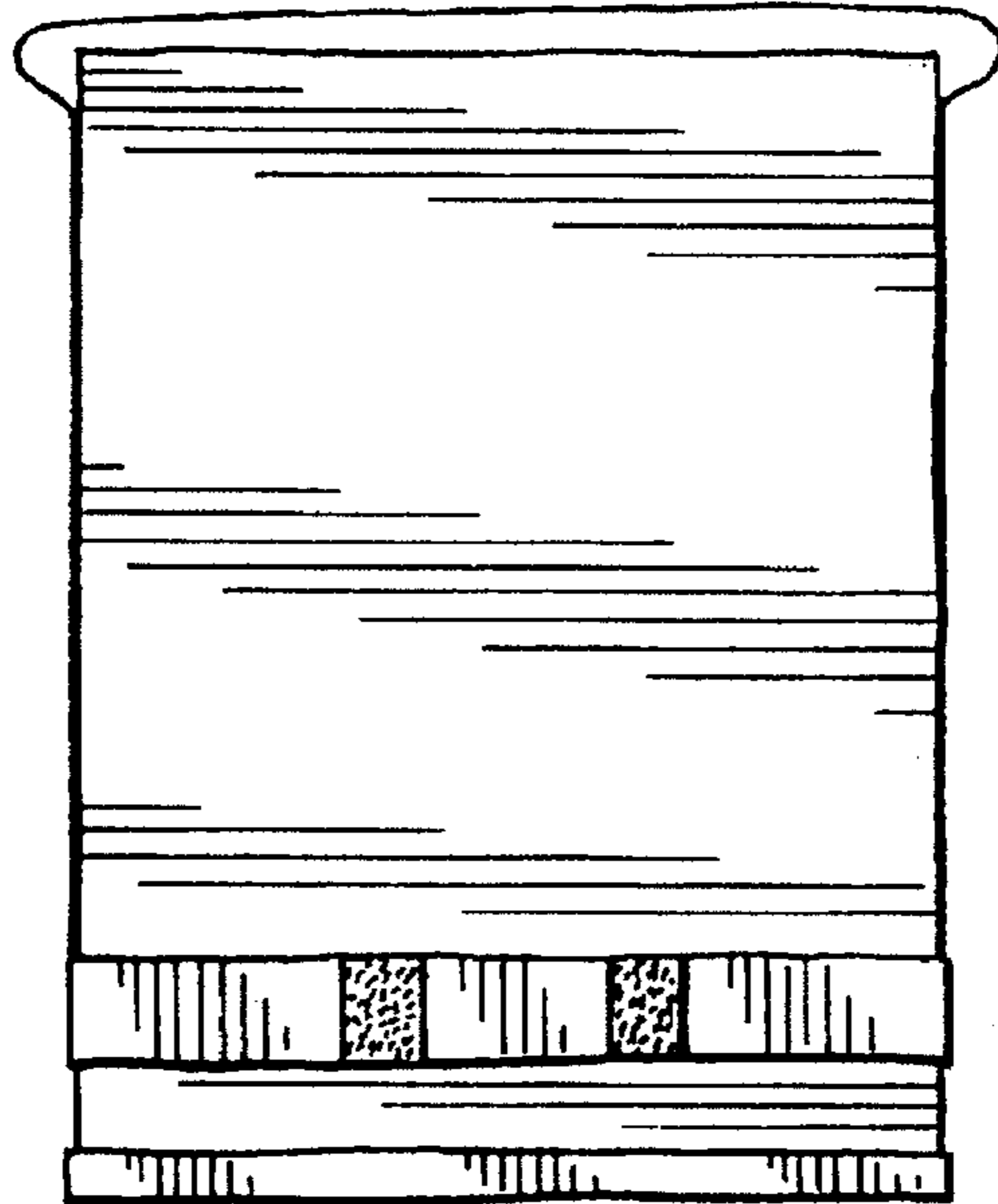

FIG. 5

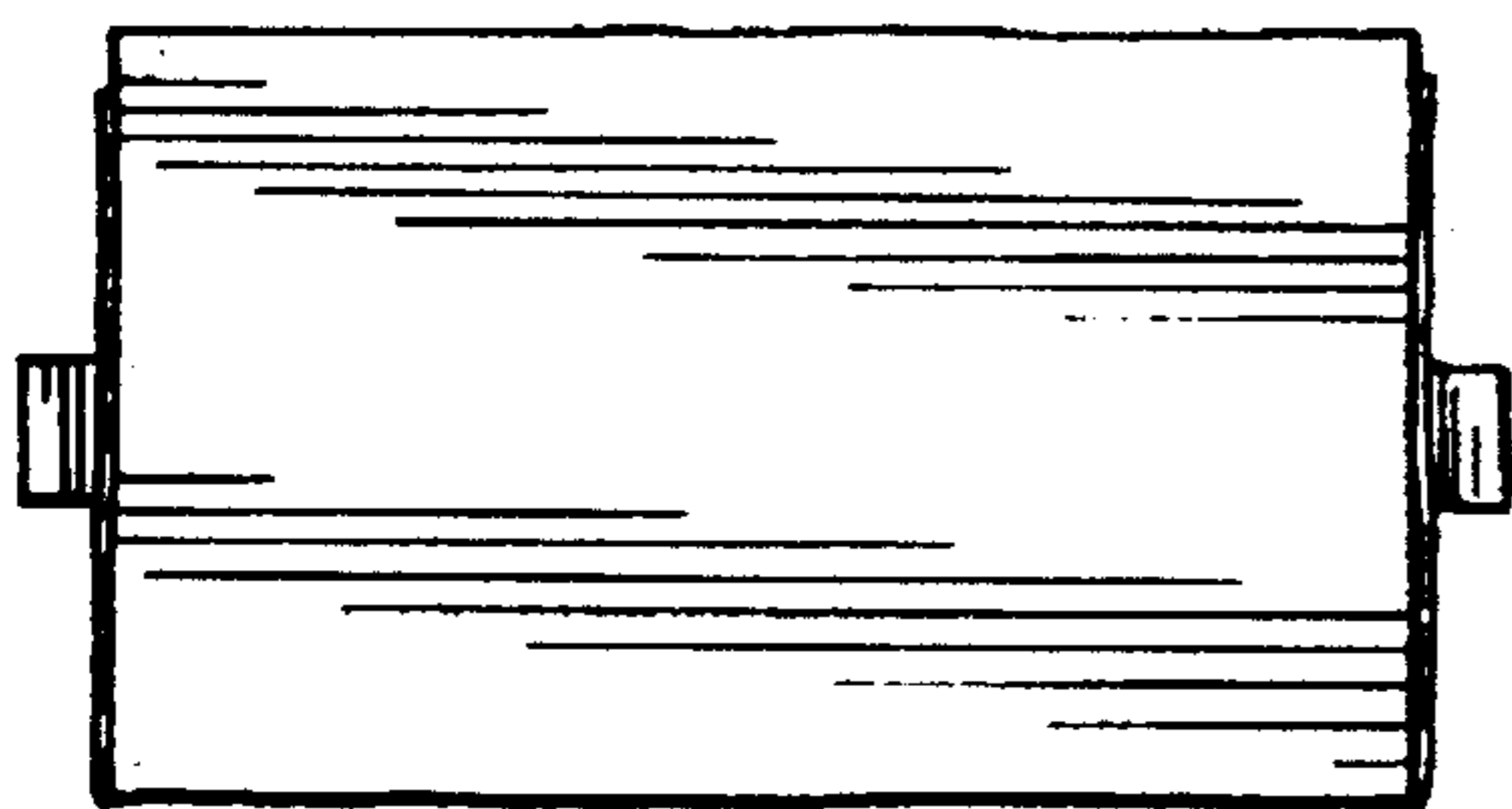

FIG. 6

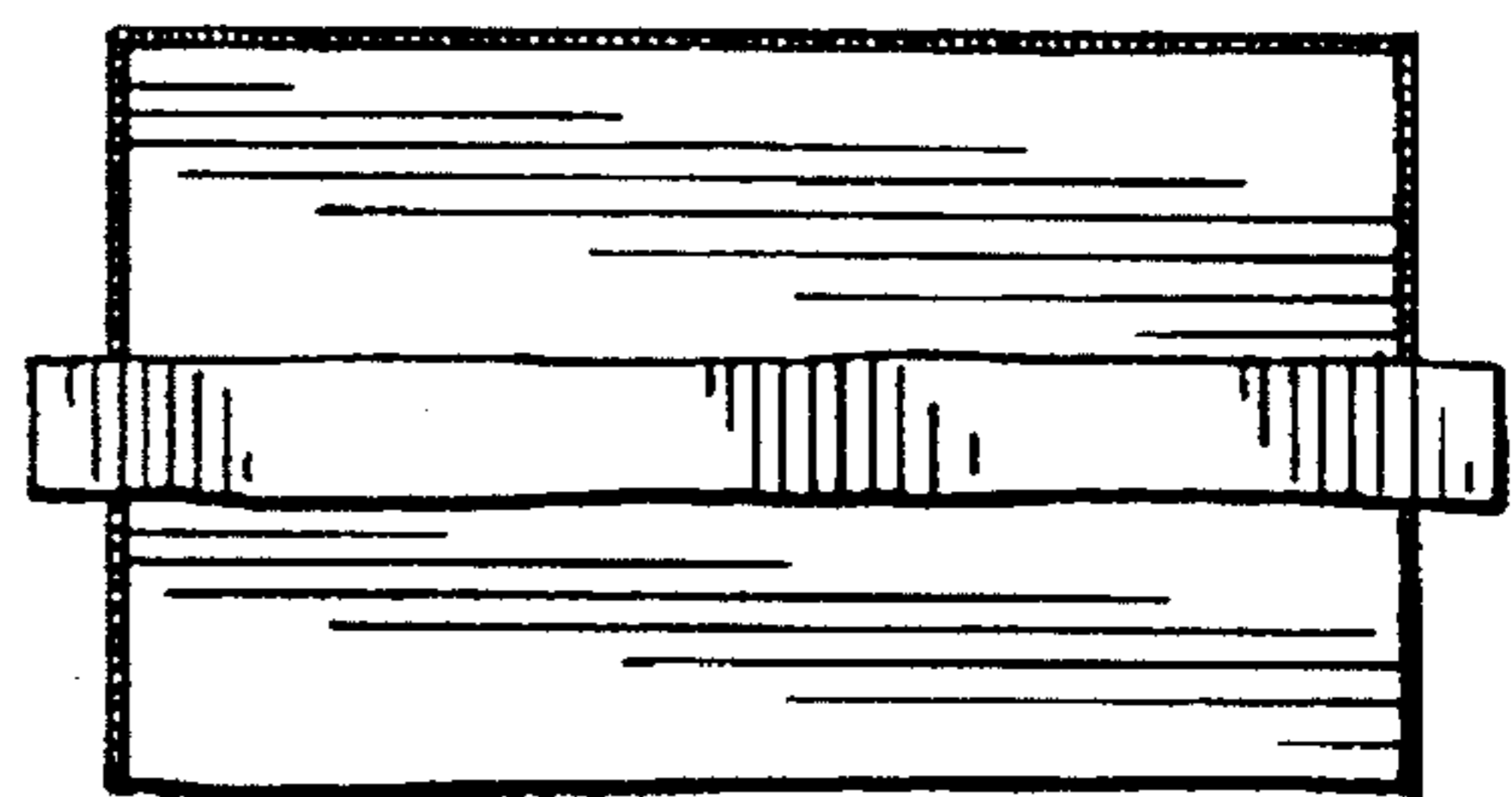

FIG. 7



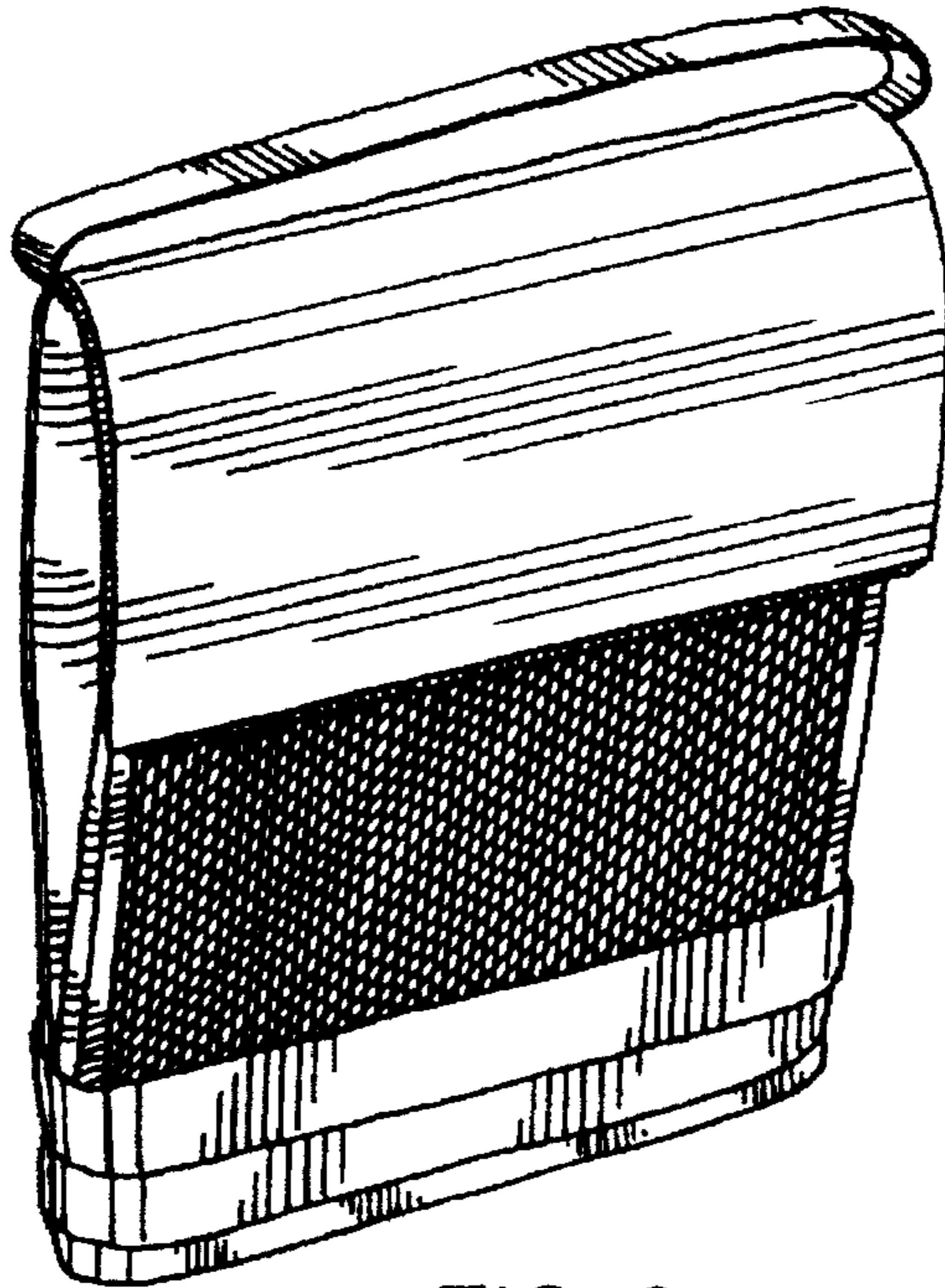

FIG. 8

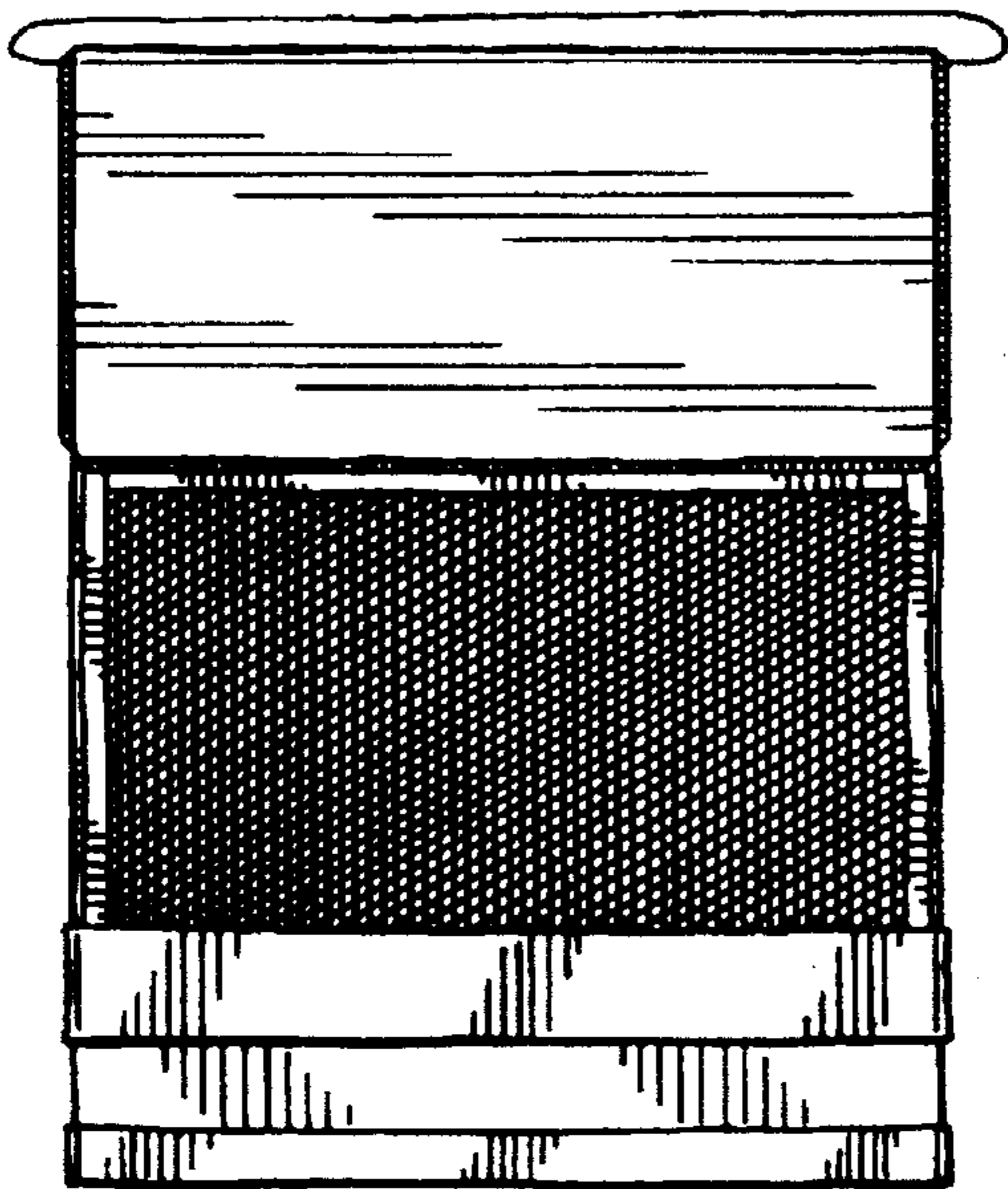

FIG. 9

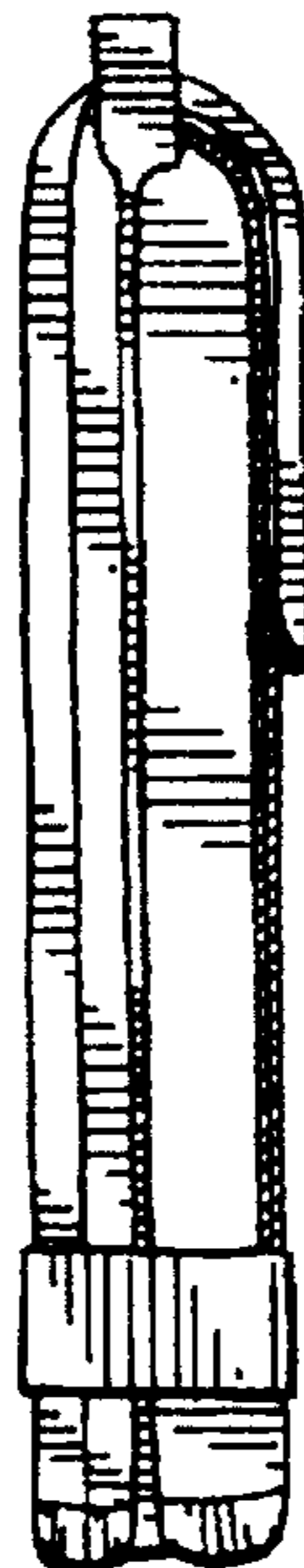

FIG. 10

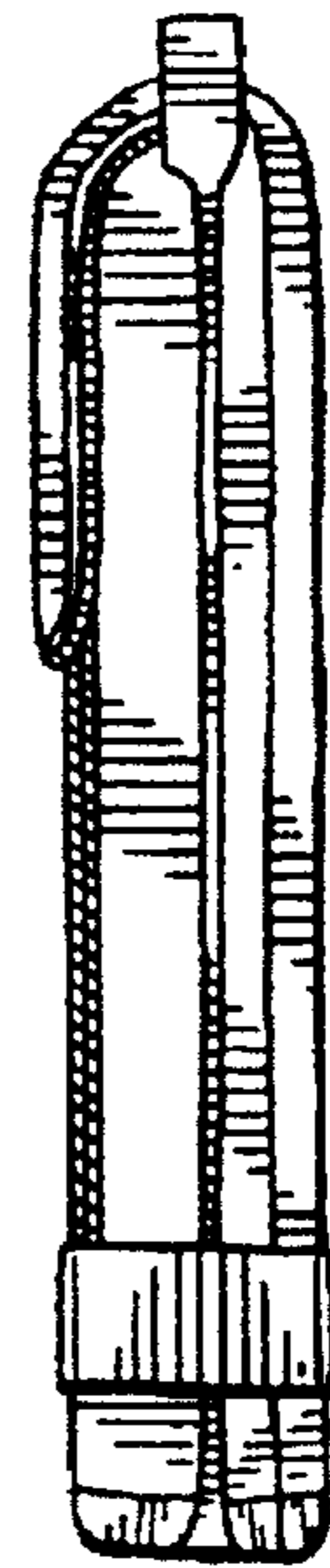

FIG. 11

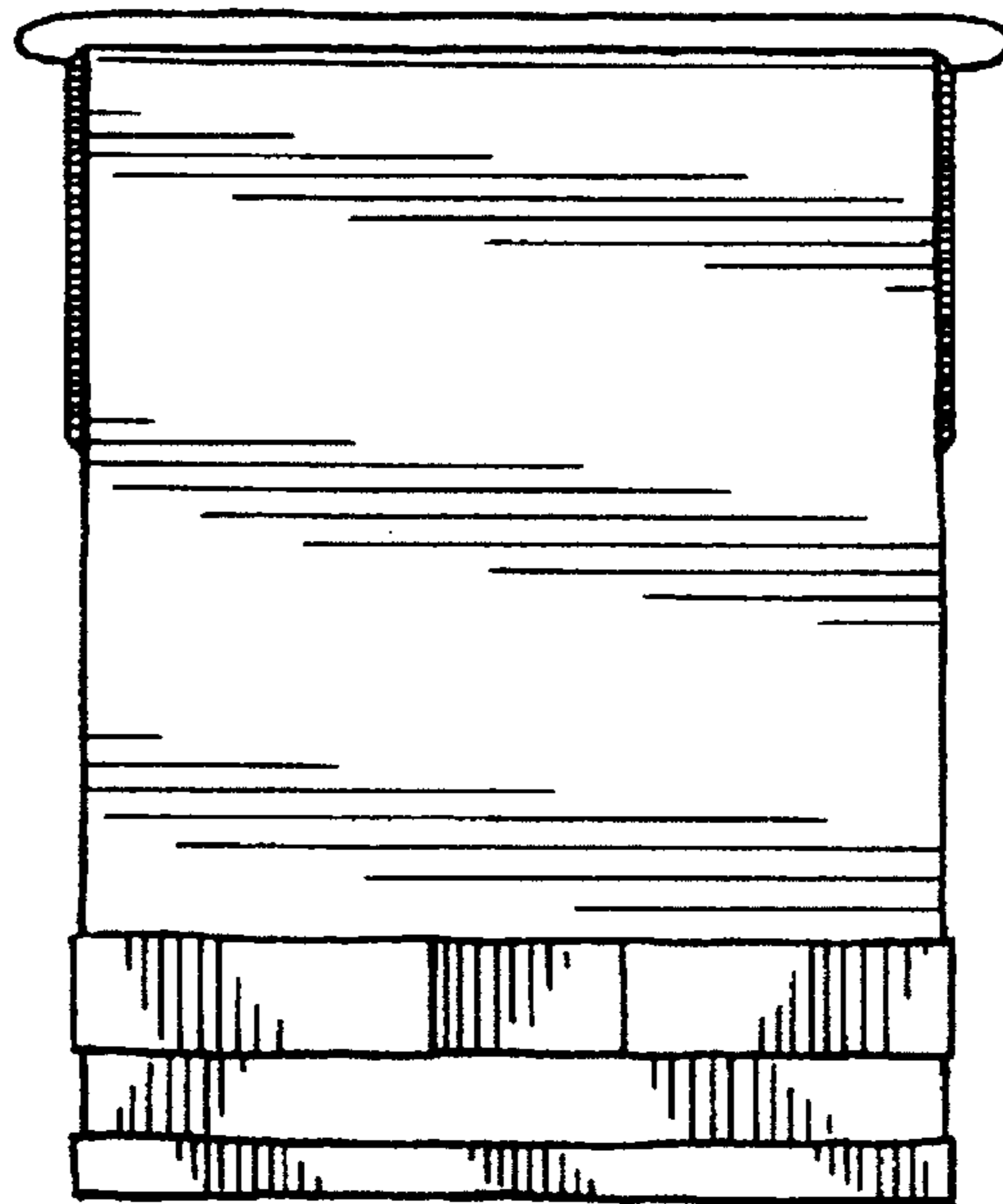

FIG. 12

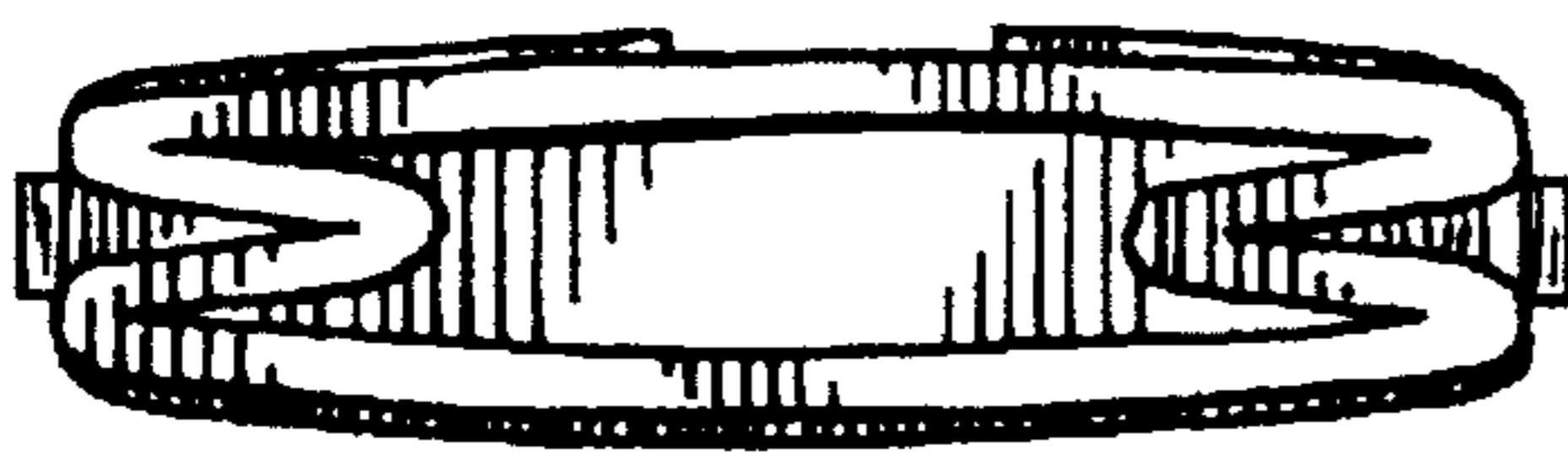

FIG. 13

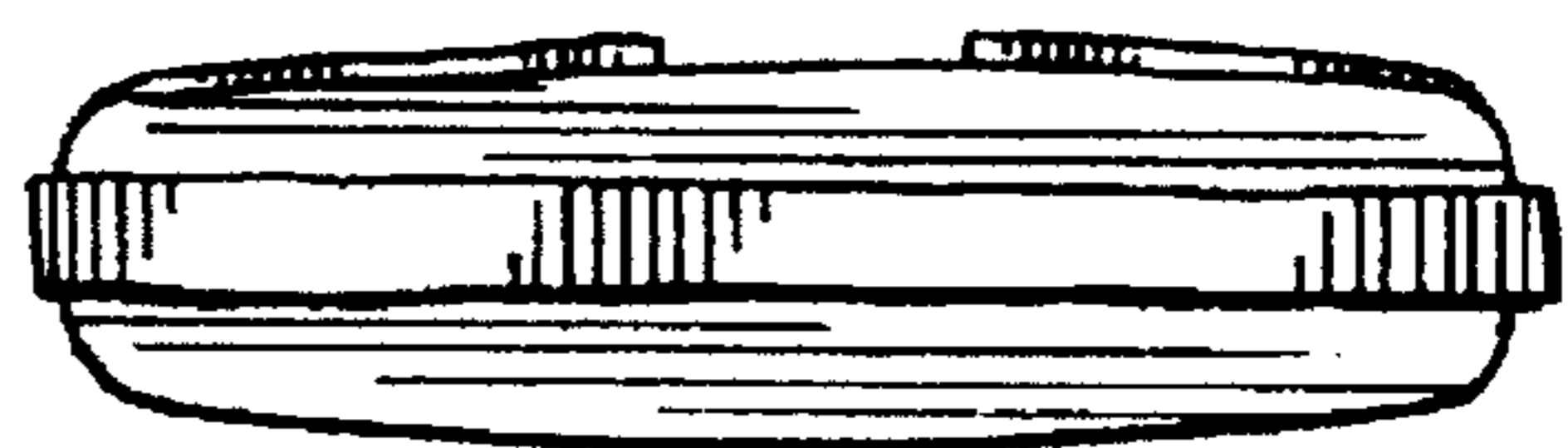

FIG. 14

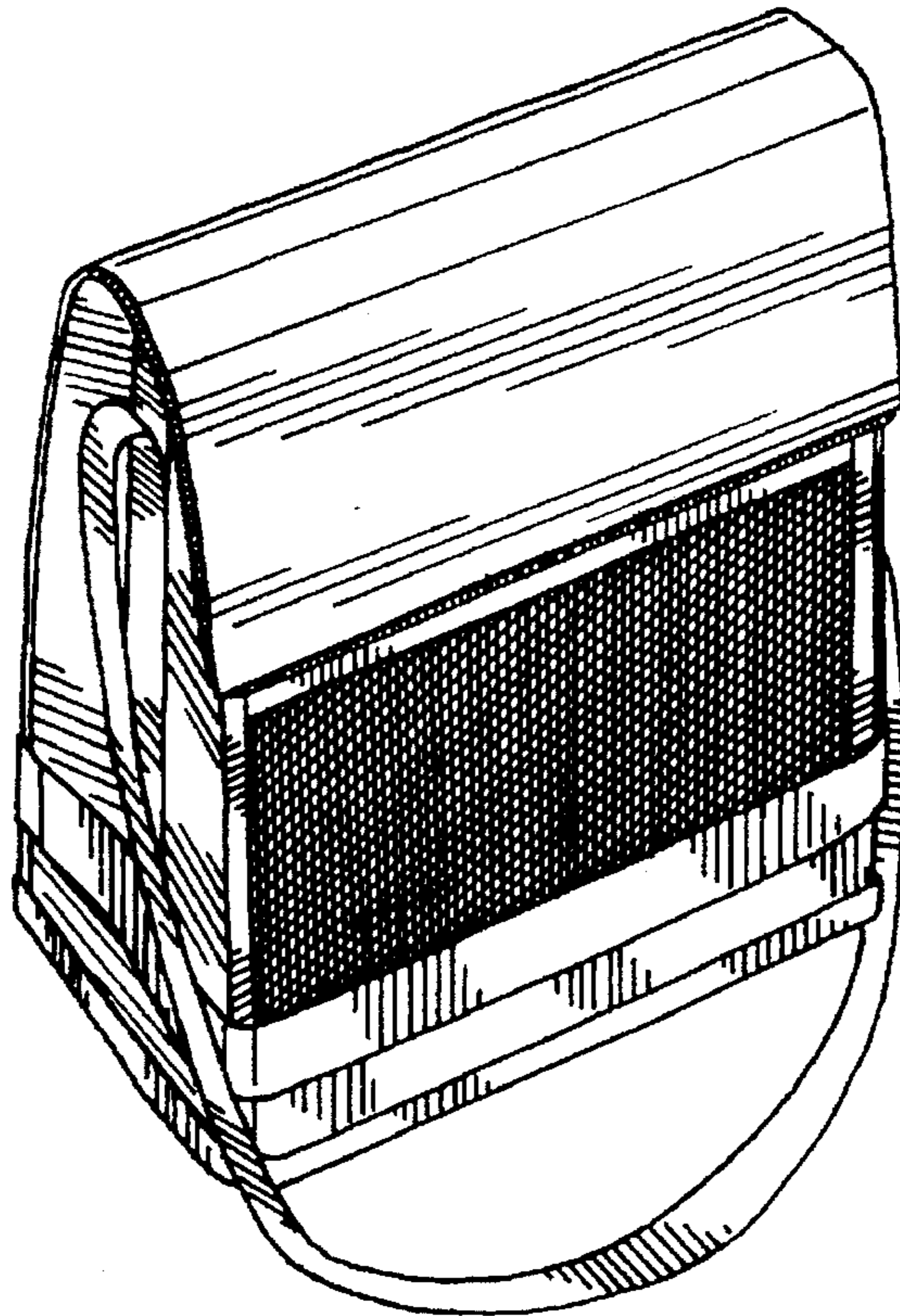

FIG. 15

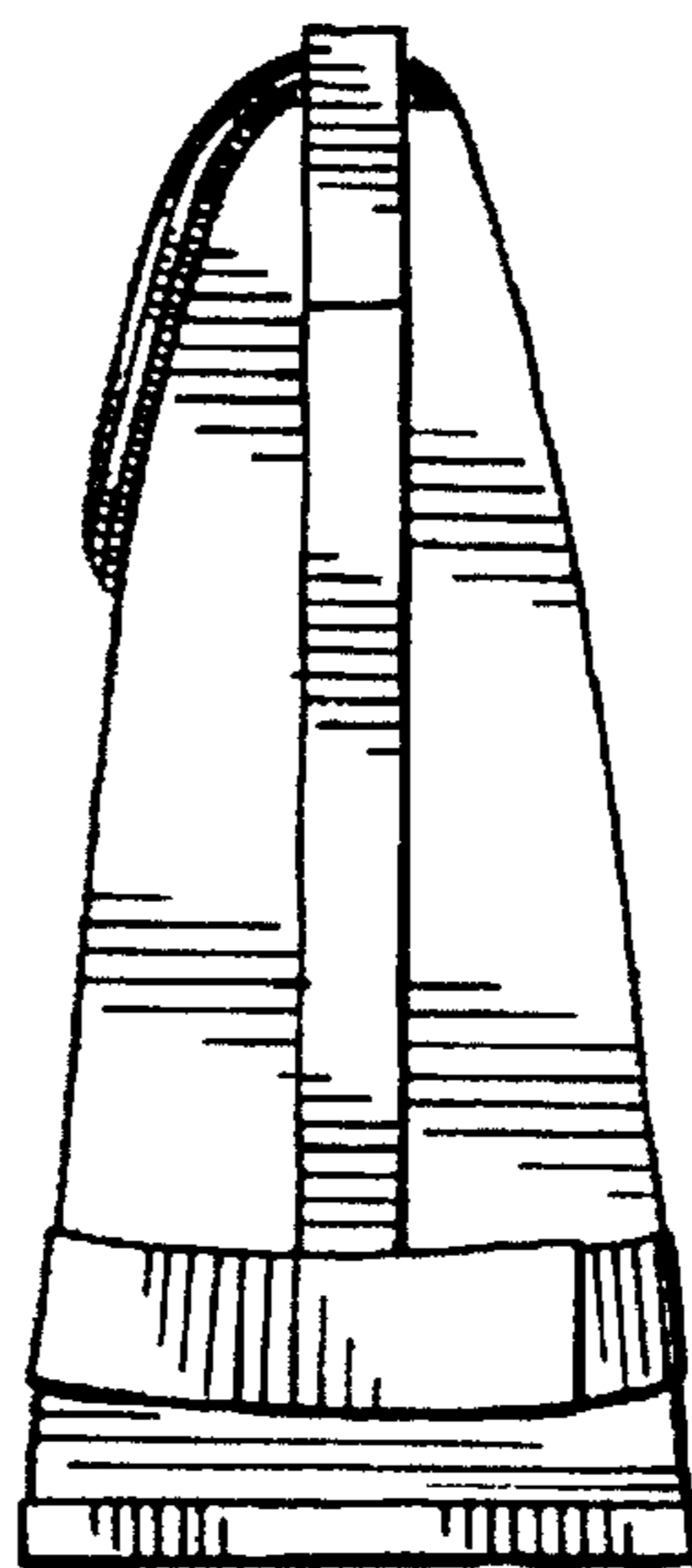

FIG. 16