



US00D382724S

United States Patent [19]

[11] Patent Number: **Des. 382,724**

Natuzzi et al.

[45] Date of Patent: ****Aug. 26, 1997**

[54] SEAT

[75] Inventors: **Pasquale Natuzzi**, Santeramo in Colle;
Arcangelo Scarati, Talsano, both of
Italy

[73] Assignee: **Industrie Natuzzi, Spa**, Bari, Italy

[**] Term: **14 Years**

[21] Appl. No.: **57,898**

[22] Filed: **Aug. 2, 1996**

[51] LOC (6) Cl. **06-01**

[52] U.S. Cl. **D6/381; D6/334; D6/335**

[58] Field of Search **D6/334, 335, 336,
D6/364, 371, 373, 377, 378, 381, 500,
501, 502; 297/232, 445.1, 446.1**

[56] References Cited

U.S. PATENT DOCUMENTS

D. 253,078	10/1979	Busnelli	D6/334
D. 293,283	12/1987	Formenti	D6/381
D. 337,692	7/1993	Natuzzi et al.	D6/381
D. 353,062	12/1994	Natuzzi et al.	D6/381
D. 358,505	5/1995	Natuzzi et al.	D6/381
D. 360,541	7/1995	Natuzzi et al.	D6/381
D. 361,909	9/1995	Natuzzi et al.	D6/381
D. 362,560	9/1995	Natuzzi et al.	D6/381
D. 363,388	10/1995	Natuzzi et al.	D6/381
D. 364,975	12/1995	Natuzzi et al.	D6/381
D. 364,976	12/1995	Natuzzi et al.	D6/381
D. 366,370	1/1996	Natuzzi et al.	D6/381
D. 367,366	2/1996	Natuzzi et al.	D6/335
D. 368,600	4/1996	Riboldi	D6/381

Primary Examiner—Gary D. Watson

Attorney, Agent, or Firm—Bell, Seltzer, Park & Gibson,
P.A.

[57] CLAIM

The ornamental design for a seat, as shown and described.

DESCRIPTION

FIG. 1 is a front perspective view of a seat showing our new design in the form of a sofa;

FIG. 2 is a front elevational view thereof;

FIG. 3 is a top plan view thereof;

FIG. 4 is a right side elevational view, the left side being a mirror image thereof;

FIG. 5 is a rear perspective view thereof;

FIG. 6 is a front elevational view of a seat showing our new design in the form of a loveseat;

FIG. 7 is front elevational view of a seat showing our new design in the form of a chair;

FIG. 8 is a front perspective view of a seat showing our new design in the form of a sectional sofa; and,

FIG. 9 is a top plan view thereof.

The broken lines shown herein are for illustrative purposes only and forms no part of the claimed design.

The rear views of FIGS. 6, 7, and 8 are like FIG. 5, the difference being substantially a matter of length.

The view of the end frames of FIGS. 6, 7, and 8 are like FIG. 4.

FIG. 1 has been shown on an enlarged scale and FIGS. 8 and 9 have been shown on a smaller scale with respect to FIGS. 2 through 7.

1 Claim, 5 Drawing Sheets

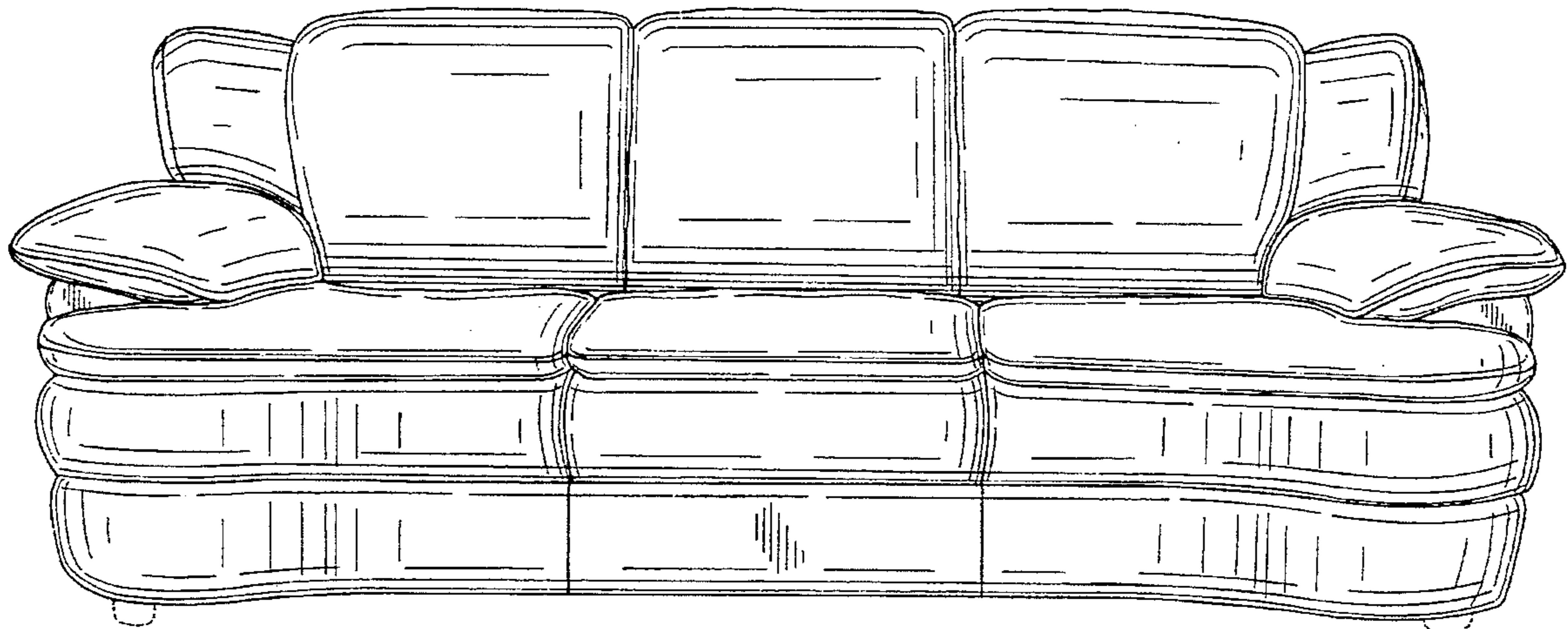

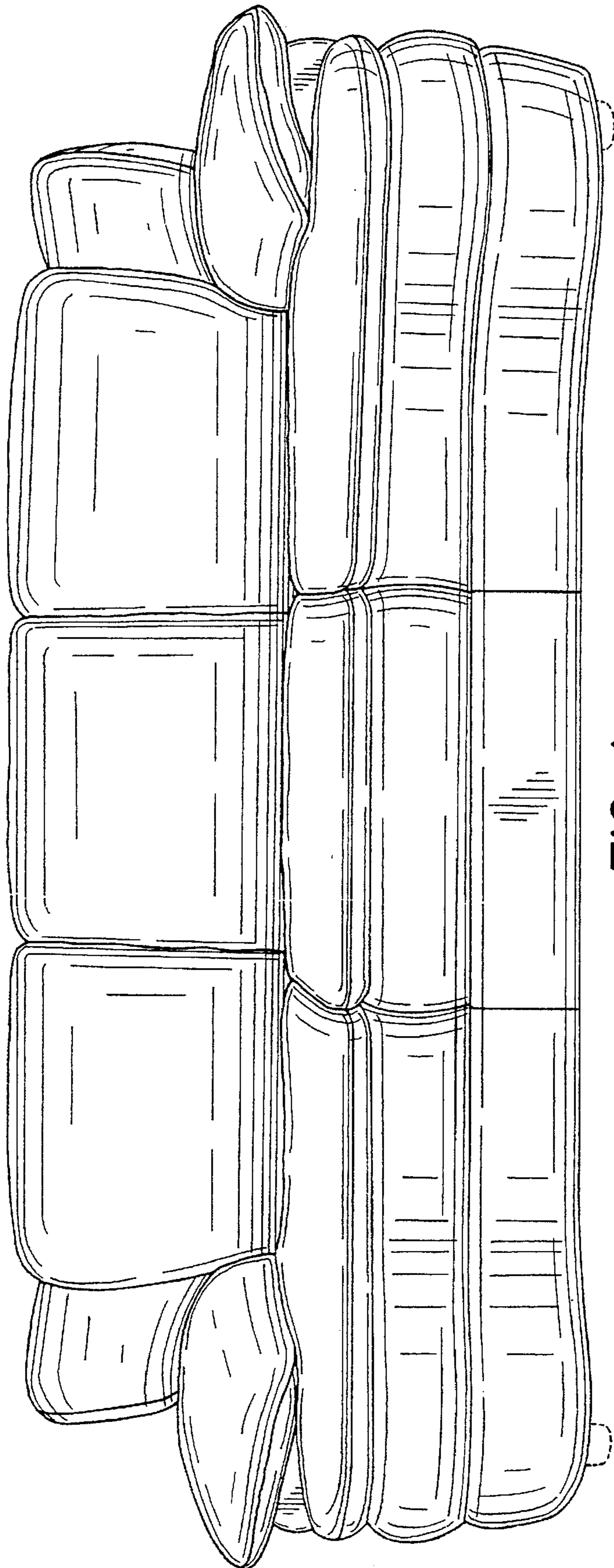

FIG. 1.

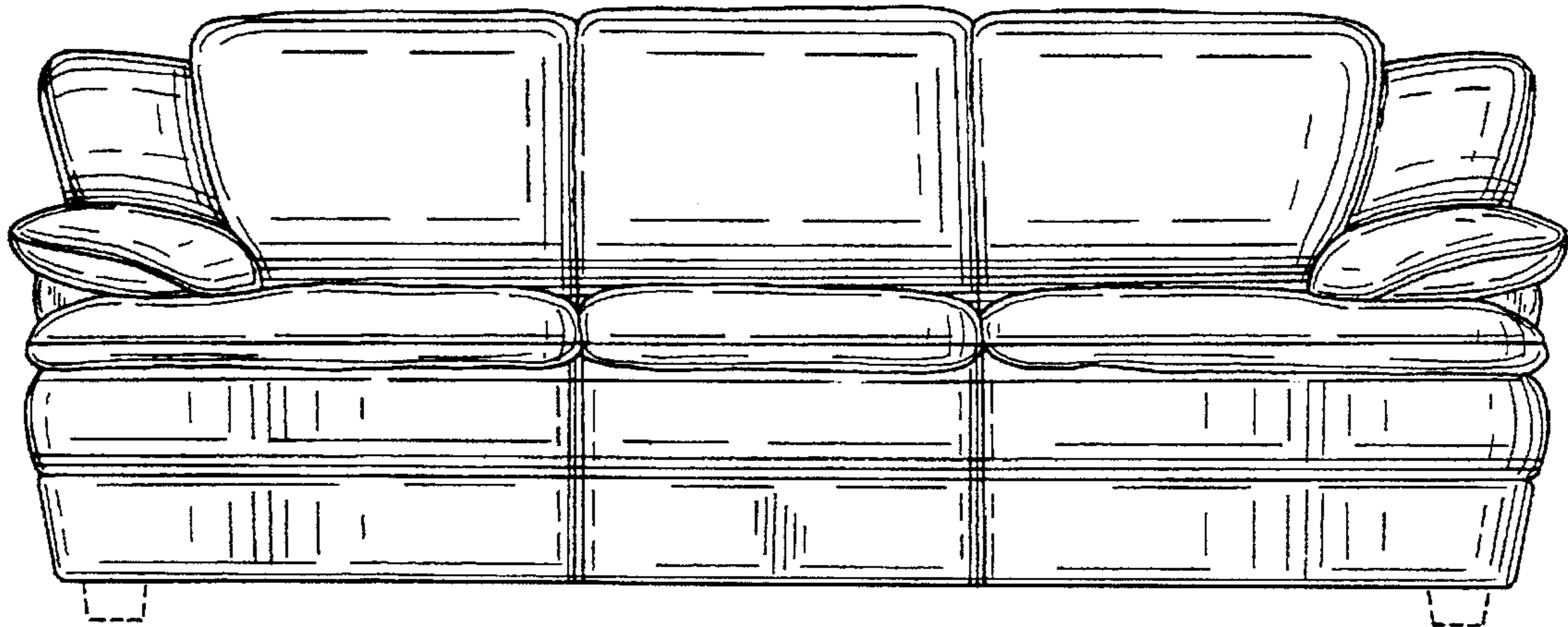

FIG. 2.

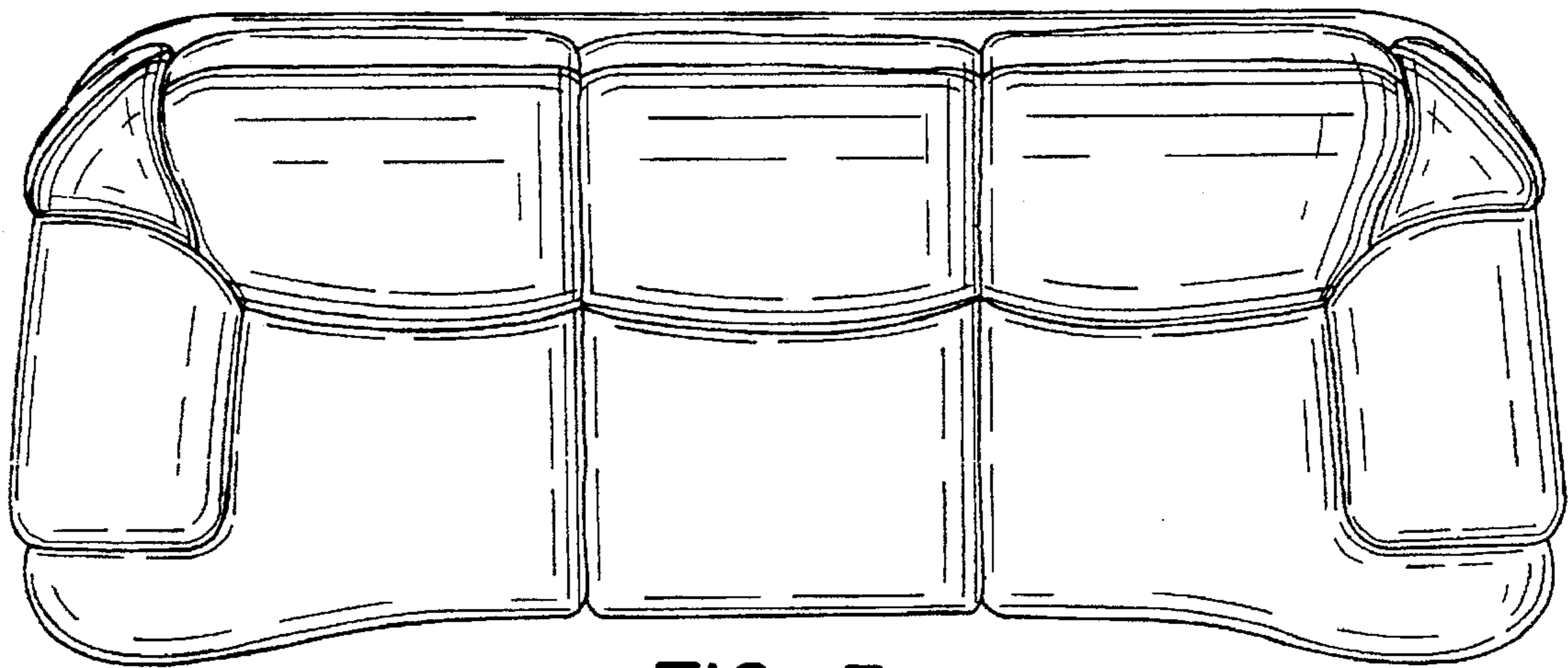

FIG. 3.

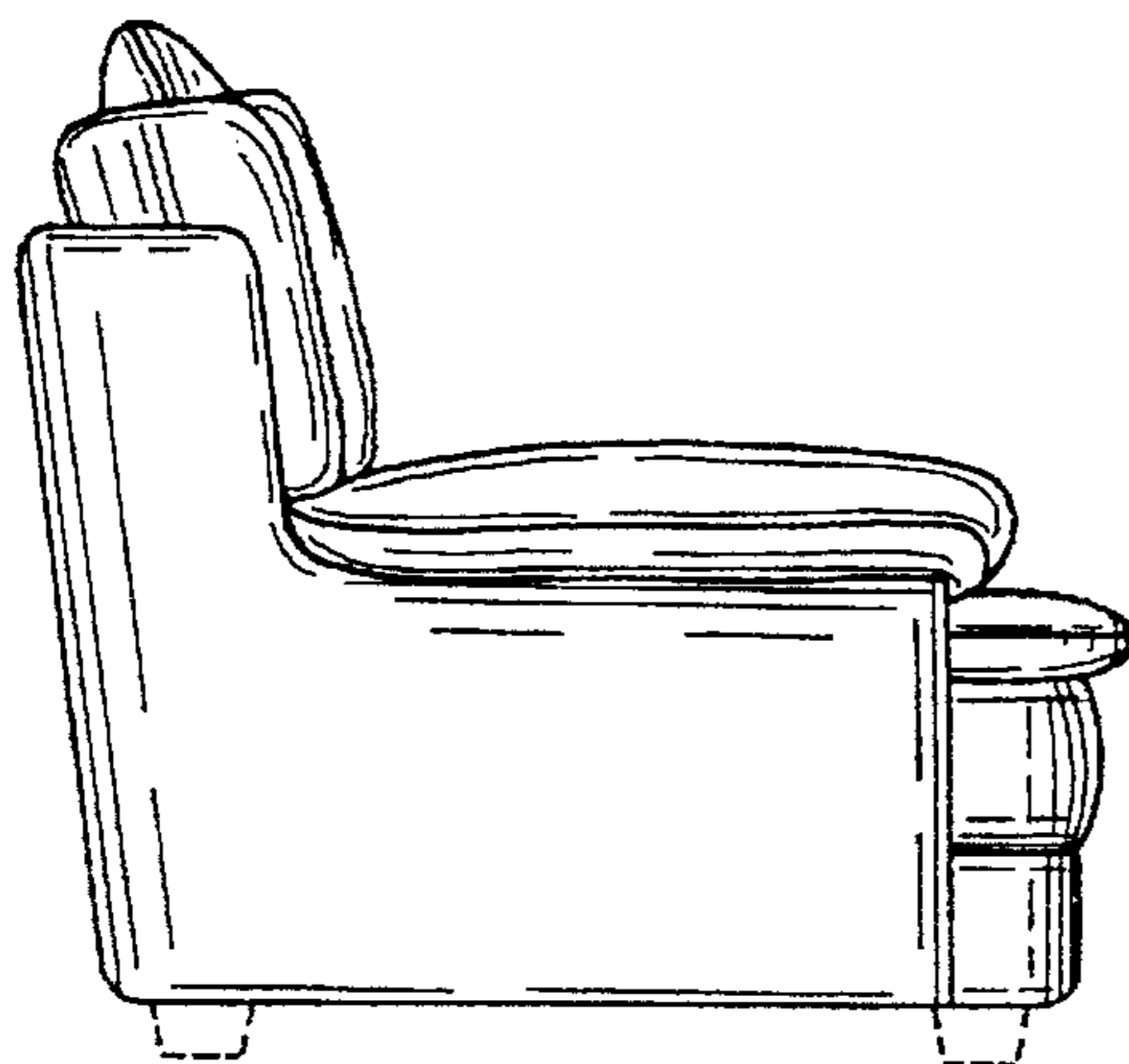

FIG. 4.

FIG. 5.

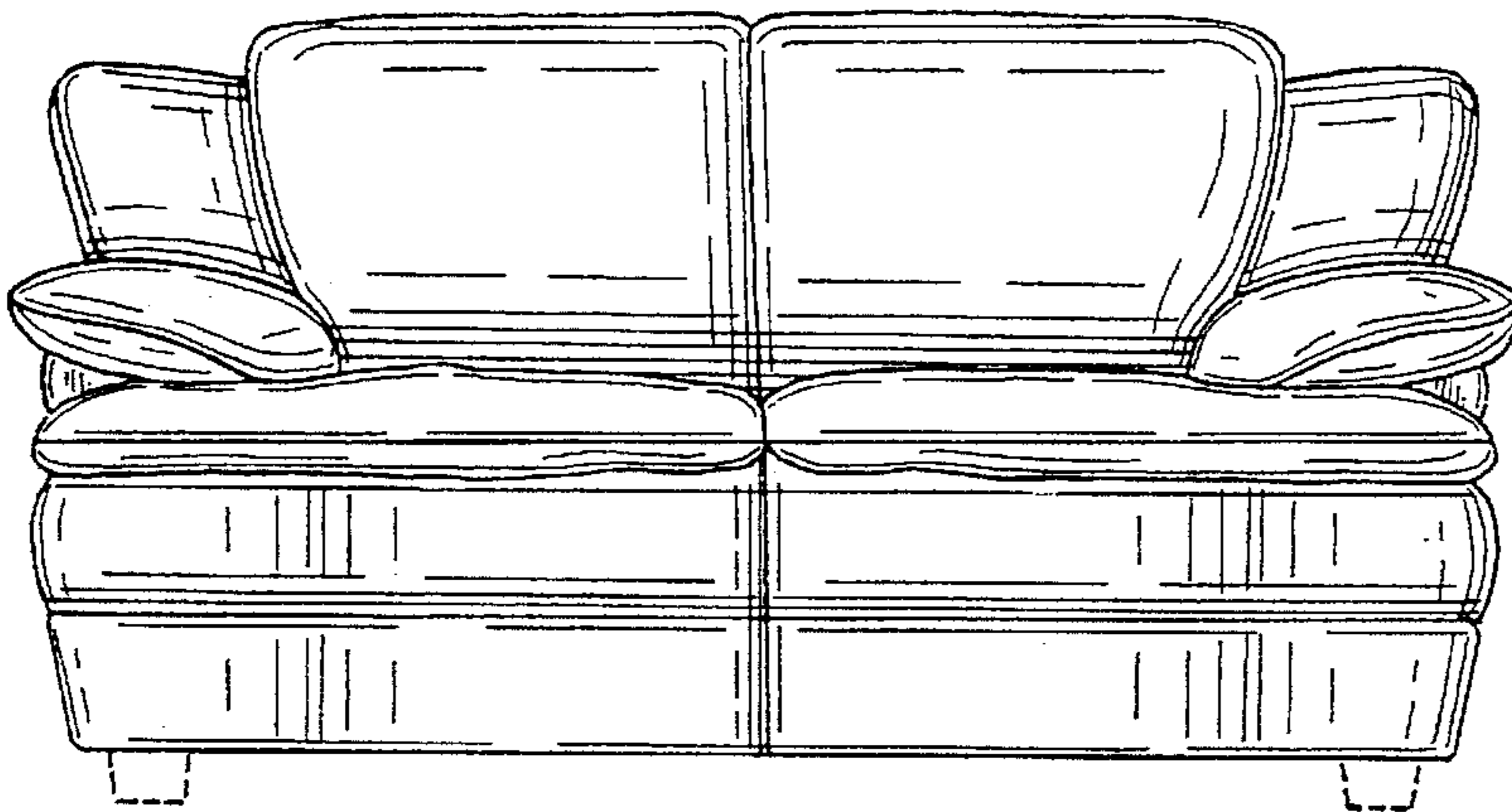
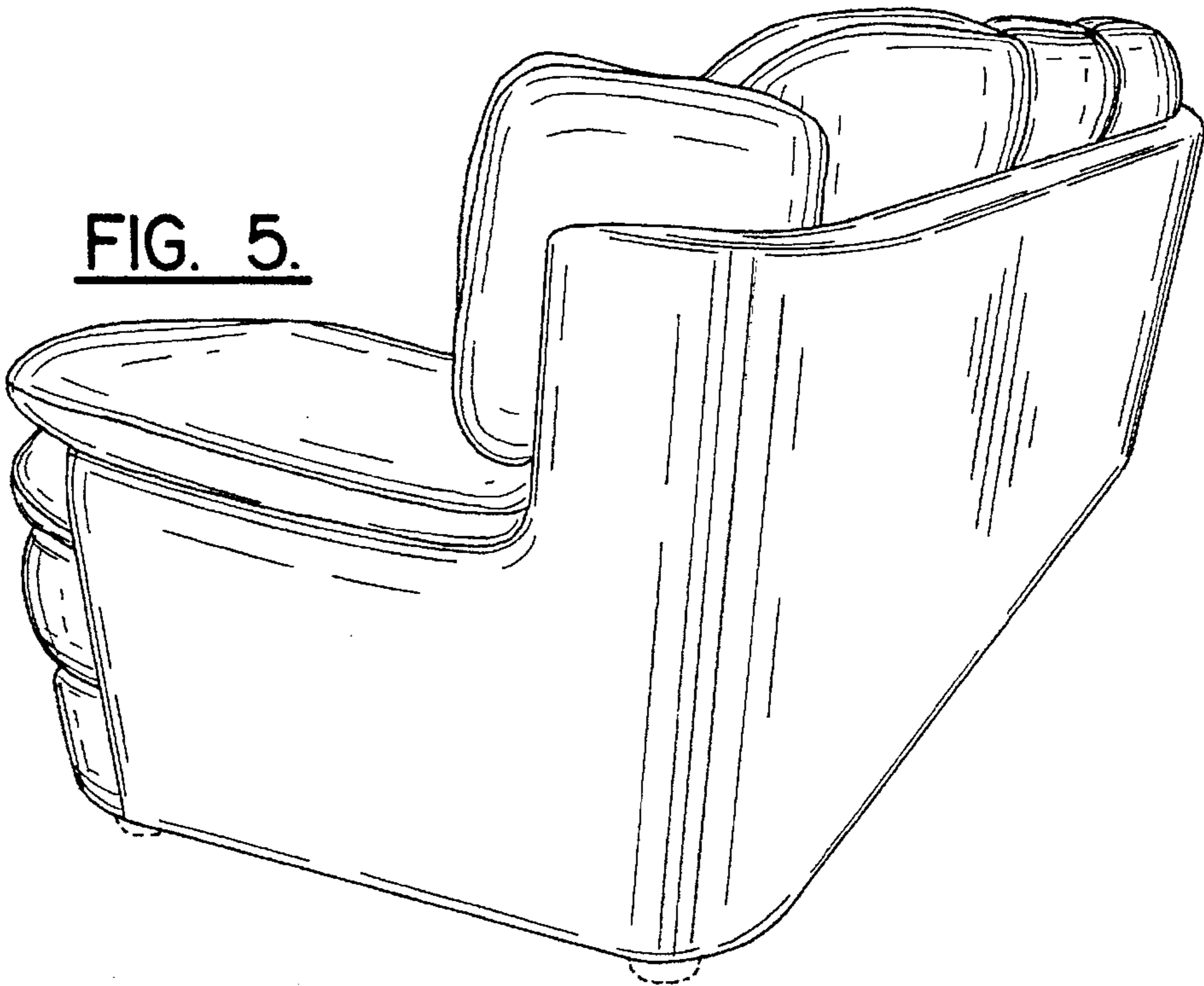
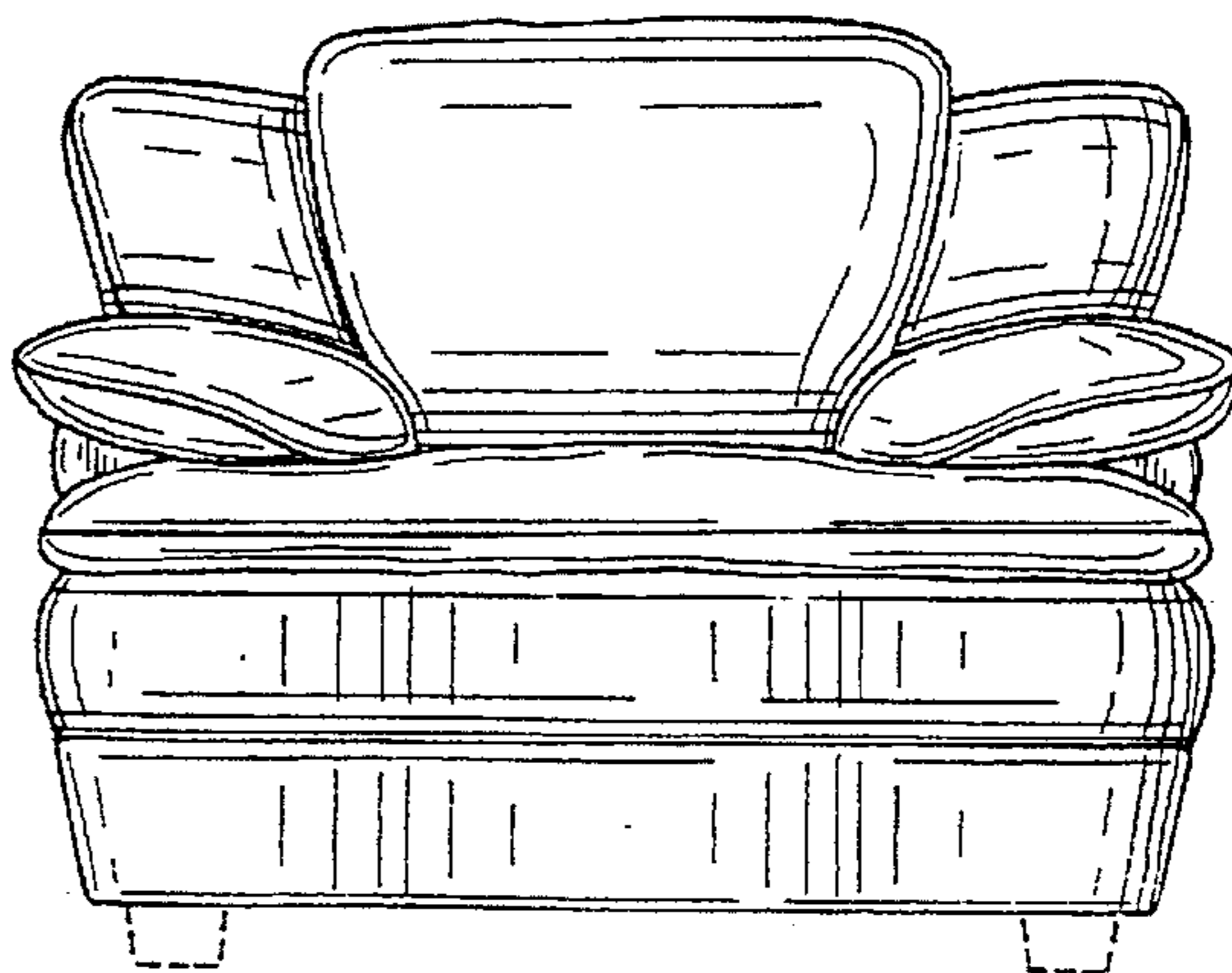

FIG. 6.

FIG. 7.



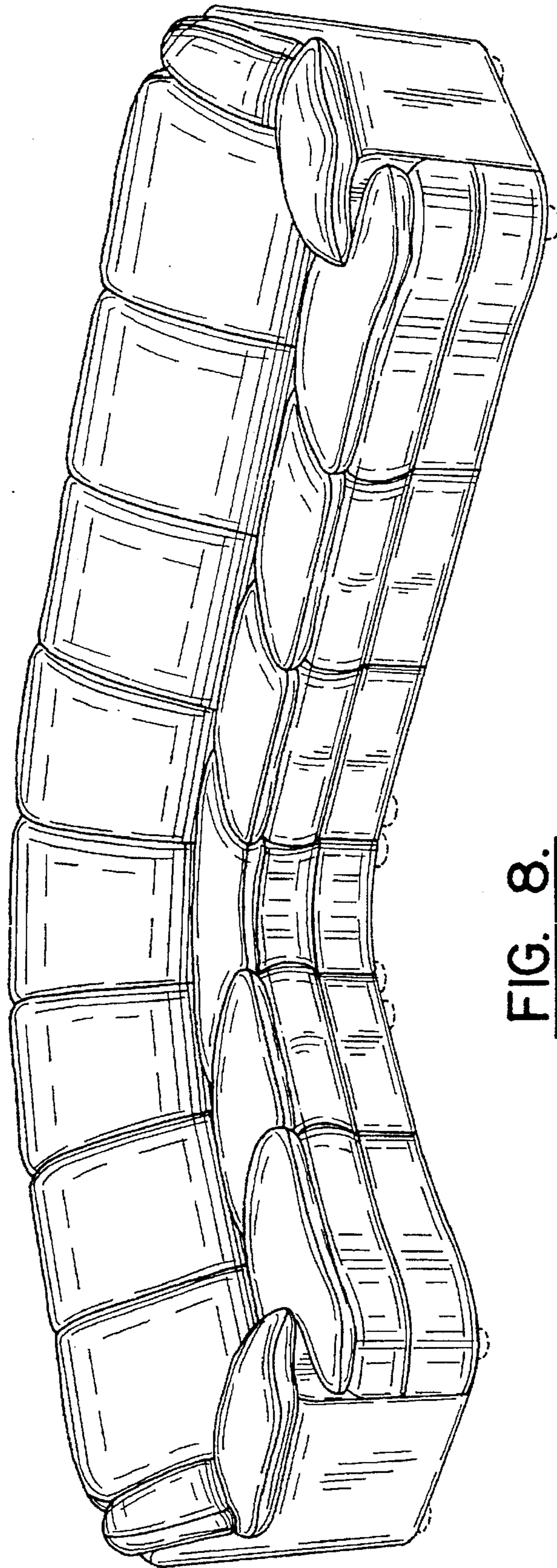

FIG. 8.

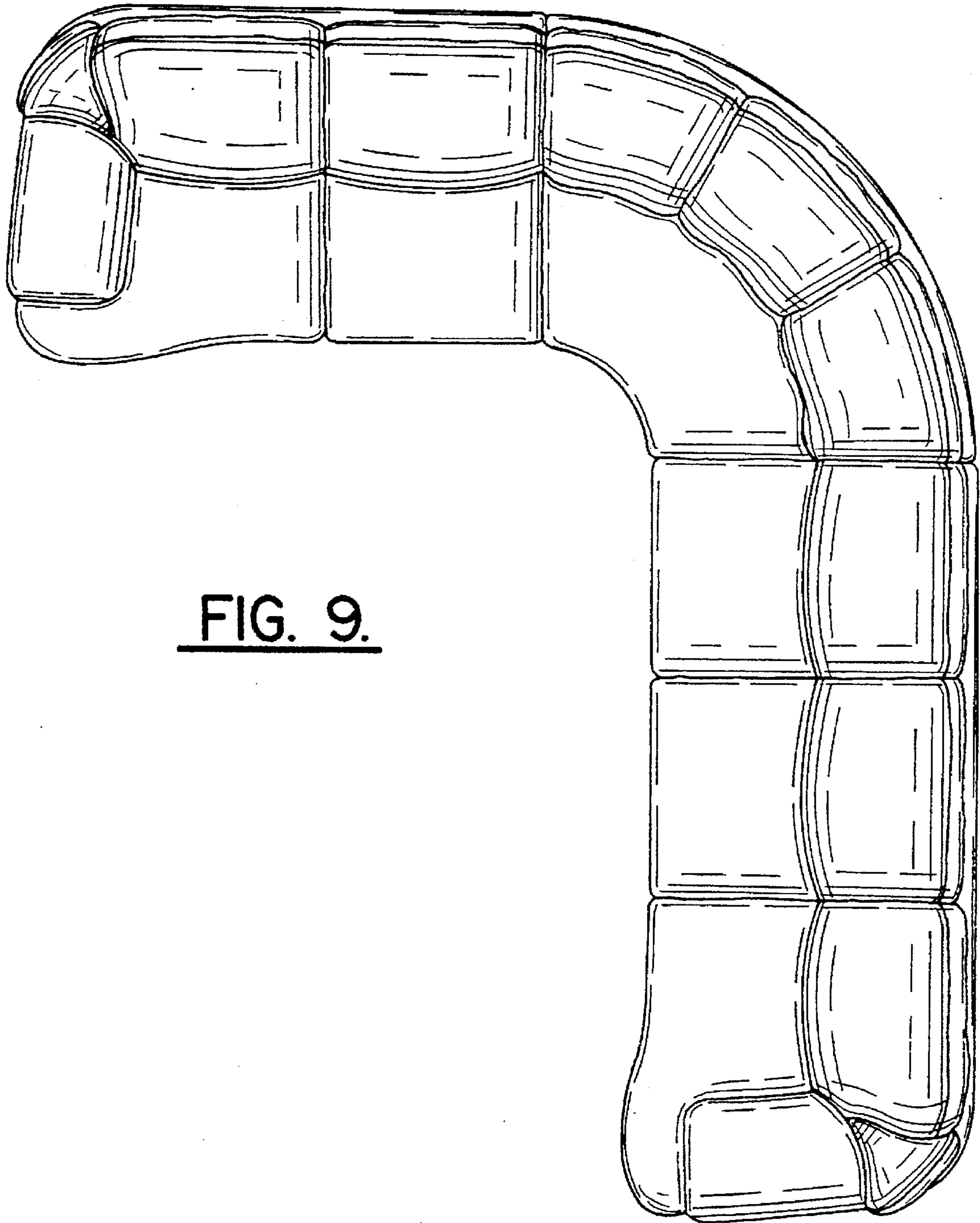

FIG. 9.

**UNITED STATES PATENT AND TRADEMARK OFFICE
CERTIFICATE OF CORRECTION**

PATENT NO. : Des.382,724
DATED : August 26, 1997
INVENTOR(S) : Natuzzi et al.

Page 1 of 3

It is certified that error appears in the above-identified patent and that said Letters Patent is hereby corrected as shown below:

On the title page, item
[56] References Cited:

Please add the following cited references as cited in Information Disclosure Statement dated August 2, 1996:

Natuzzi Model 154, October 1986, at International Home Furnishings Market in High Point, North Carolina

Natuzzi Model 619, October 1988, at International Home Furnishings Market in High Point, North Carolina

Natuzzi Model 792, October 1990, at International Home Furnishings Market in High Point, North Carolina

Natuzzi Model 797, October 1990, at International Home Furnishings Market in High Point, North Carolina

Natuzzi Model 827, April 1991, at International Home Furnishings Market in High Point, North Carolina

Natuzzi Model 864, October 1991, at International Home Furnishings Market in High Point, North Carolina

Natuzzi Model 881, October 1991, at International Home Furnishings Market in High Point, North Carolina

Natuzzi Model 897, April 1992, at International Home Furnishings Market in High Point, North Carolina

Natuzzi Model 910, April 1992, at International Home Furnishings Market in High Point, North Carolina

**UNITED STATES PATENT AND TRADEMARK OFFICE
CERTIFICATE OF CORRECTION**

PATENT NO. : Des.382,724
DATED : August 26, 1997
INVENTOR(S) : Natuzzi et al.

Page 2 of 3

It is certified that error appears in the above-identified patent and that said Letters Patent is hereby corrected as shown below:

Natuzzi Model 1033, March 1993, at International Home Furnishings Market in High Point, North Carolina

Natuzzi Model 1043, April 1993, at International Home Furnishings Market in High Point, North Carolina

Natuzzi Model 1068, September 1993, at International Home Furnishings Market in High Point, North Carolina

Natuzzi Model 1087, September 1993, at International Home Furnishings Market in High Point, North Carolina

Natuzzi Model 1107, October 1993, at International Home Furnishings Market in High Point, North Carolina

Natuzzi Model 1123, January 1994, at International Home Furnishings Market in High Point, North Carolina

Natuzzi Model 1235, October 1994, at International Home Furnishings Market in High Point, North Carolina

Natuzzi Model 1309, April 1995, at International Home Furnishings Market in High Point, North Carolina

UNITED STATES PATENT AND TRADEMARK OFFICE
CERTIFICATE OF CORRECTION

PATENT NO. : Des.382,724
DATED : August 26, 1997
INVENTOR(S) : Natuzzi et al.

Page 3 of 3

It is certified that error appears in the above-identified patent and that said Letters Patent is hereby corrected as shown below:

Natuzzi Model 1309, April 1995, at International
Home Furnishings Market in High Point, North Carolina

Signed and Sealed this

Thirteenth Day of January, 1998



Attest:

BRUCE LEHMAN

Attesting Officer

Commissioner of Patents and Trademarks