



US00D382723S

United States Patent [19]

[11] Patent Number: Des. 382,723

Natuzzi et al.

[45] Date of Patent: **Aug. 26, 1997

[54] SEAT

[75] Inventors: **Pasquale Natuzzi; Raffaella Lucarelli**, both of Santeramo in Colle, Italy

[73] Assignee: **Industrie Natuzzi Spa**, Bari, Italy

[**] Term: **14 Years**

[21] Appl. No.: **57,896**

[22] Filed: **Aug. 2, 1996**

[51] LOC (6) Cl. **06-01**

[52] U.S. Cl. **D6/381; D6/334**

[58] Field of Search D6/334, 335, 336, D6/364, 371, 373, 381, 500, 501, 502; 297/232

[56] References Cited

U.S. PATENT DOCUMENTS

D. 289,711	5/1987	Bick et al.	D6/381
D. 355,309	2/1995	Natuzzi et al.	D6/381
D. 363,614	10/1995	Natuzzi et al.	D6/381
D. 365,940	1/1996	Schweiger	D6/381
D. 365,953	1/1996	Natuzzi et al.	D6/381
D. 367,364	2/1996	Lewis	D6/334
D. 369,478	5/1996	Riboldi	D6/381
D. 372,370	8/1996	Natuzzi et al.	D6/381

OTHER PUBLICATIONS

Natuzzi Model 488, Apr. 1989, at International Home Furnishings Market in High Point, North Carolina.
 Natuzzi Model 499, Apr. 1989, at International Home Furnishings Market in High Point, North Carolina.
 Natuzzi Model 616/617, Oct. 1988, at International Home Furnishings Market in High Point, North Carolina.
 Natuzzi Model 622/623, Oct. 1988, at International Home Furnishings Market in High Point, North Carolina.
 Natuzzi Model 664/665, Oct. 1991, at International Home Furnishings Market in High Point, North Carolina.
 Natuzzi Model 753, Apr. 1990, at International Home Furnishings Market in High Point, North Carolina.
 Natuzzi Model 788, Oct. 1990, at International Home Furnishings Market in High Point, North Carolina.

Natuzzi Model 811, Oct. 1990, at International Home Furnishings Market in High Point, North Carolina.
 Natuzzi Model 814, Oct. 1990, at International Home Furnishings Market in High Point, North Carolina.
 Natuzzi Model 825, Nov. 1990, at International Home Furnishings Market in High Point, North Carolina.
 Natuzzi Model 841, Apr. 1991, at International Home Furnishings Market in High Point, North Carolina.
 Natuzzi Model 971, Oct. 1992, at International Home Furnishings Market in High Point, North Carolina.
 Natuzzi Model 1025, Apr. 1993, at International Home Furnishings Market in High Point, North Carolina.
 Natuzzi Model 1032, Apr. 1993, at International Home Furnishings Market in High Point, North Carolina.
 Natuzzi Model 1081, Oct. 1993, at International Home Furnishings Market in High Point, North Carolina.

(List continued on next page.)

Primary Examiner—Gary D. Watson
Attorney, Agent, or Firm—Bell, Seltzer, Park & Gibson, P.A.

[57] CLAIM

The ornamental design for a seat, as shown and described.

DESCRIPTION

FIG. 1 is a front perspective view of a seat showing our new design in the form of a sofa;
 FIG. 2 is a front elevational view thereof;
 FIG. 3 is a top plan view thereof;
 FIG. 4 is a right side elevational view, the left side being a mirror image thereof;
 FIG. 5 is a rear perspective view thereof;
 FIG. 6 is a front elevational view of a seat showing our new design in the form of a loveseat; and,
 FIG. 7 is a front elevational view of a seat showing our new design in the form of a chair.
 The broken lines shown herein are for illustrative purposes only and form no part of the claimed design.
 The rear views of FIGS. 6 and 7 are like FIG. 5, the difference being a matter of length.
 The end frames of FIGS. 6 and 7 are like FIG. 4.

1 Claim, 3 Drawing Sheets

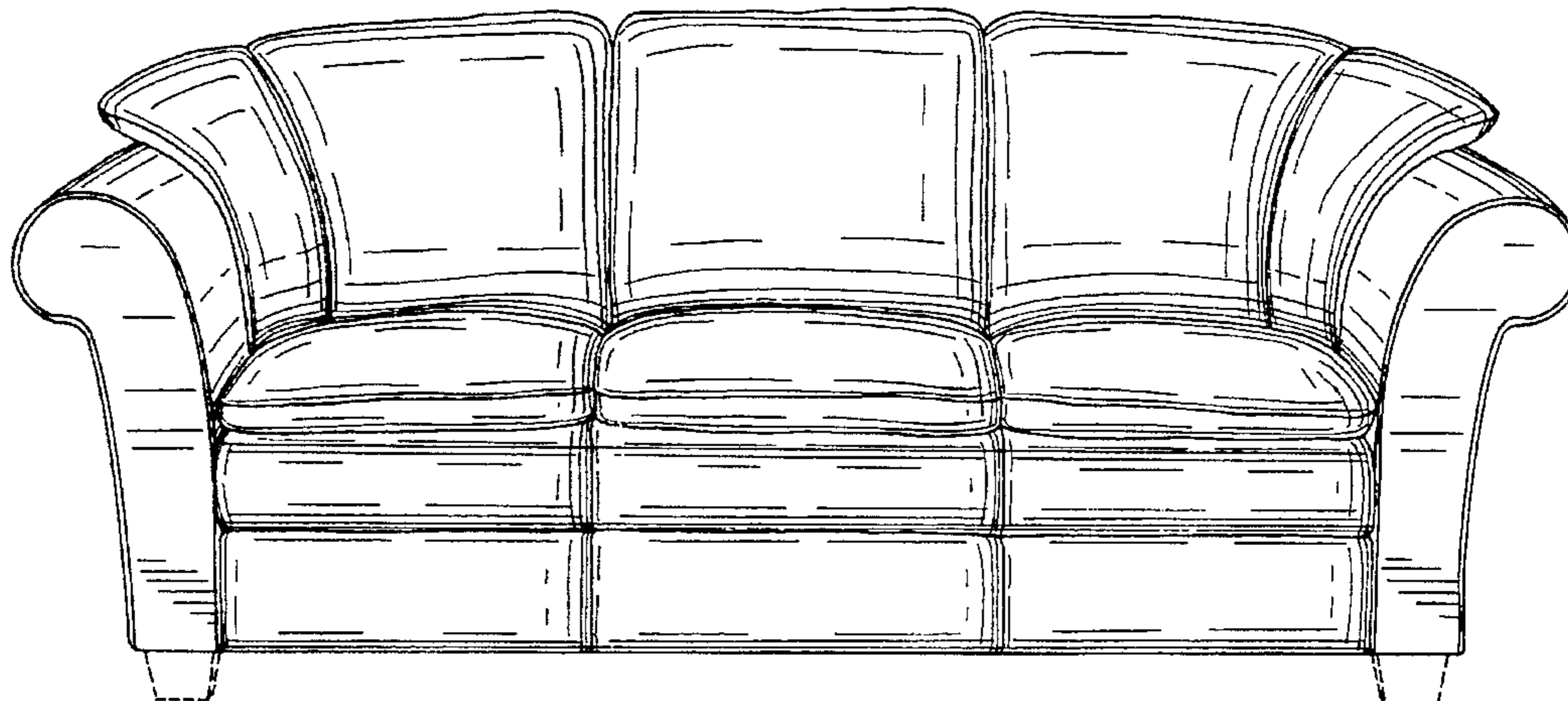

OTHER PUBLICATIONS

Natuzzi Model 1084, Oct. 1993, at International Home Furnishings Market in High Point, North Carolina.

Natuzzi Model 1096, Oct. 1993, at International Home Furnishings Market in High Point, North Carolina.

Natuzzi Model 1099, Oct. 1993, at International Home Furnishings Market in High Point, North Carolina.

Natuzzi Model 1100, Oct. 1993, at International Home Furnishings Market in High Point, North Carolina.

Natuzzi Model 1209, Oct. 1994, at International Home Furnishings Market in High Point, North Carolina.

Natuzzi Model 1216, Oct. 1994, at International Home Furnishings Market in High Point, North Carolina.

Natuzzi Model 1257, Mar. 1995, at International Home Furnishings Market in High Point, North Carolina.

Natuzzi Model 1266, Mar. 1995, at International Home Furnishings Market in High Point, North Carolina.

Natuzzi Model 1302, Mar. 1995, at International Home Furnishings Market in High Point, North Carolina.

Natuzzi Model 1317, Apr. 1995, at International Home Furnishings Market in High Point, North Carolina.

Natuzzi Model 1338, Sep. 1995, at International Home Furnishings Market in High Point, North Carolina.

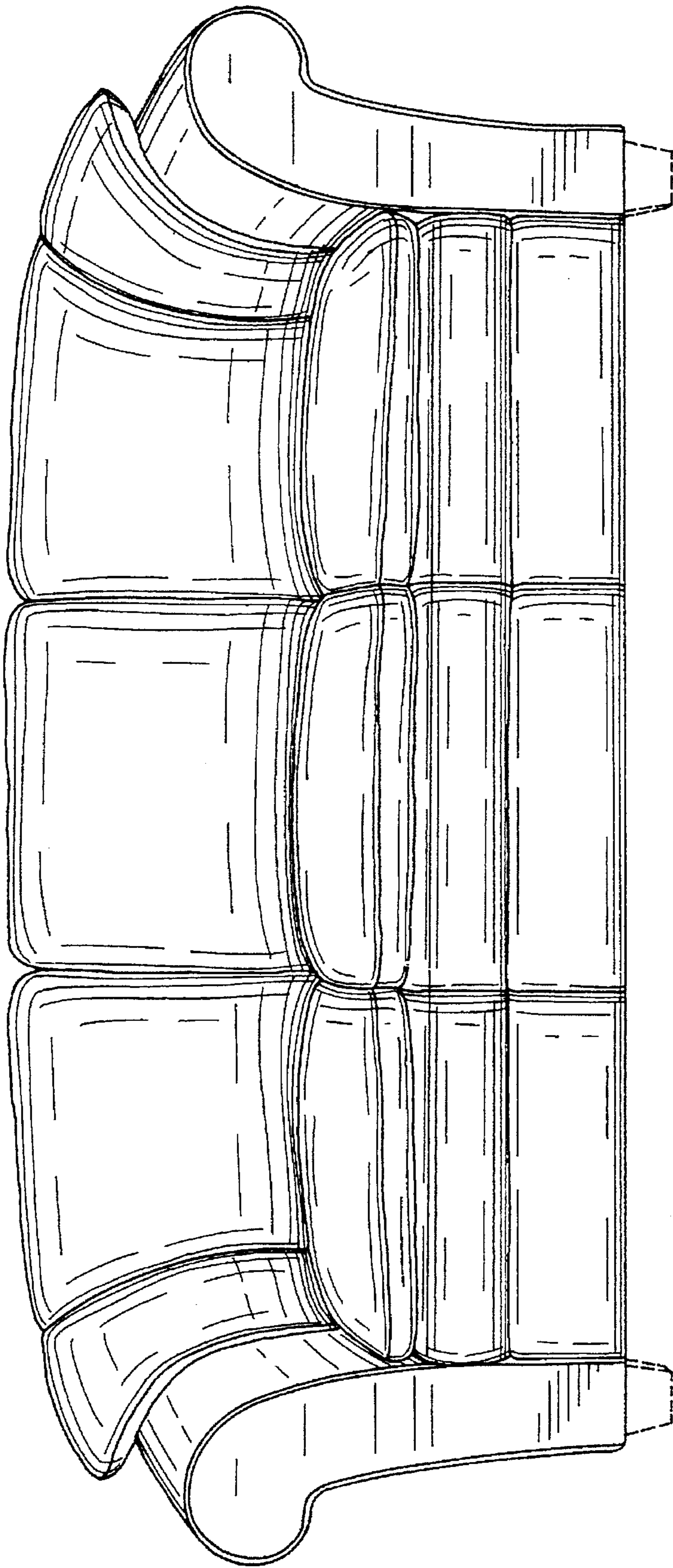

FIG. 1.

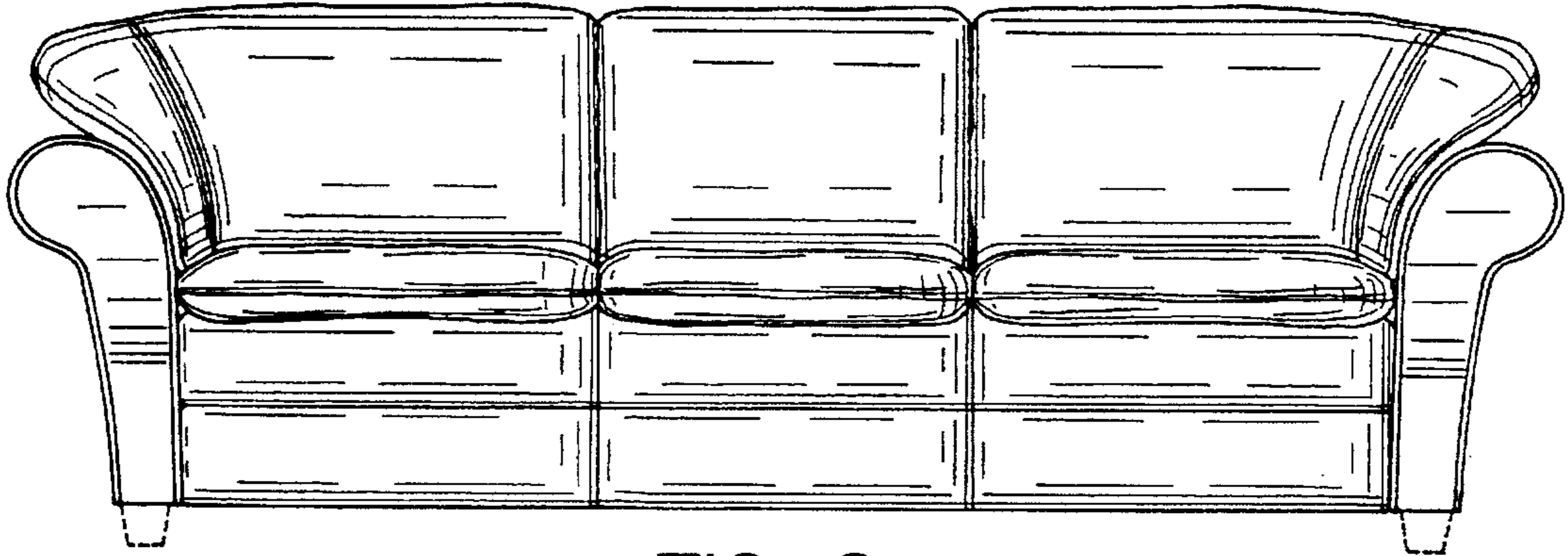

FIG. 2.

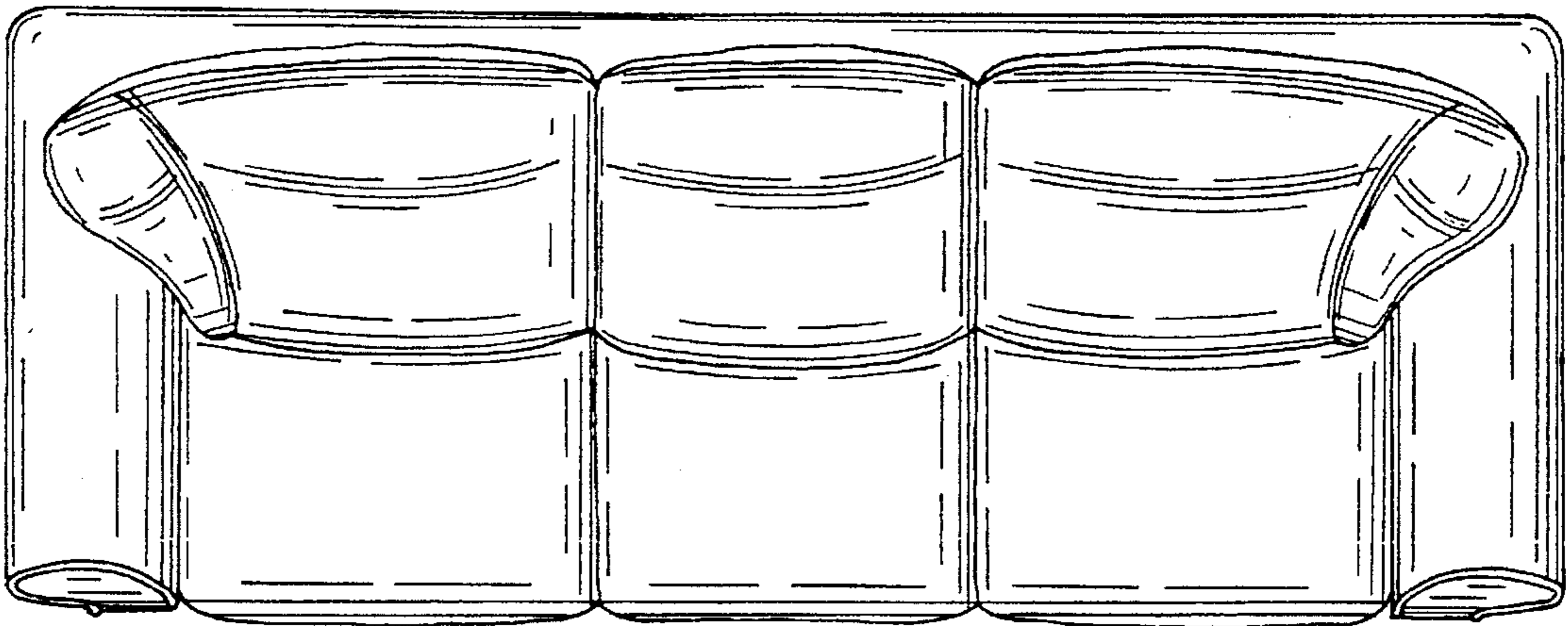

FIG. 3.

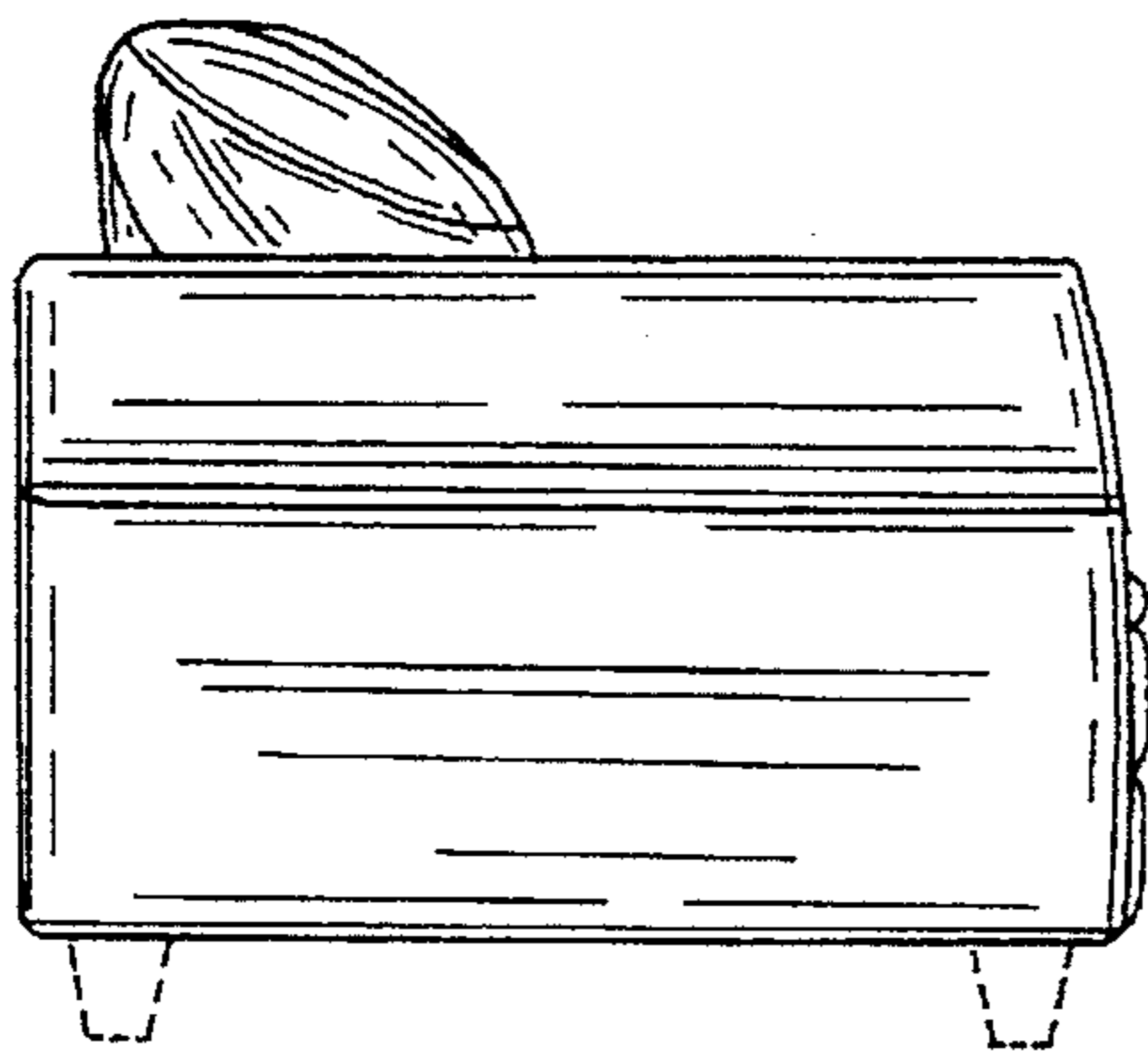

FIG. 4.

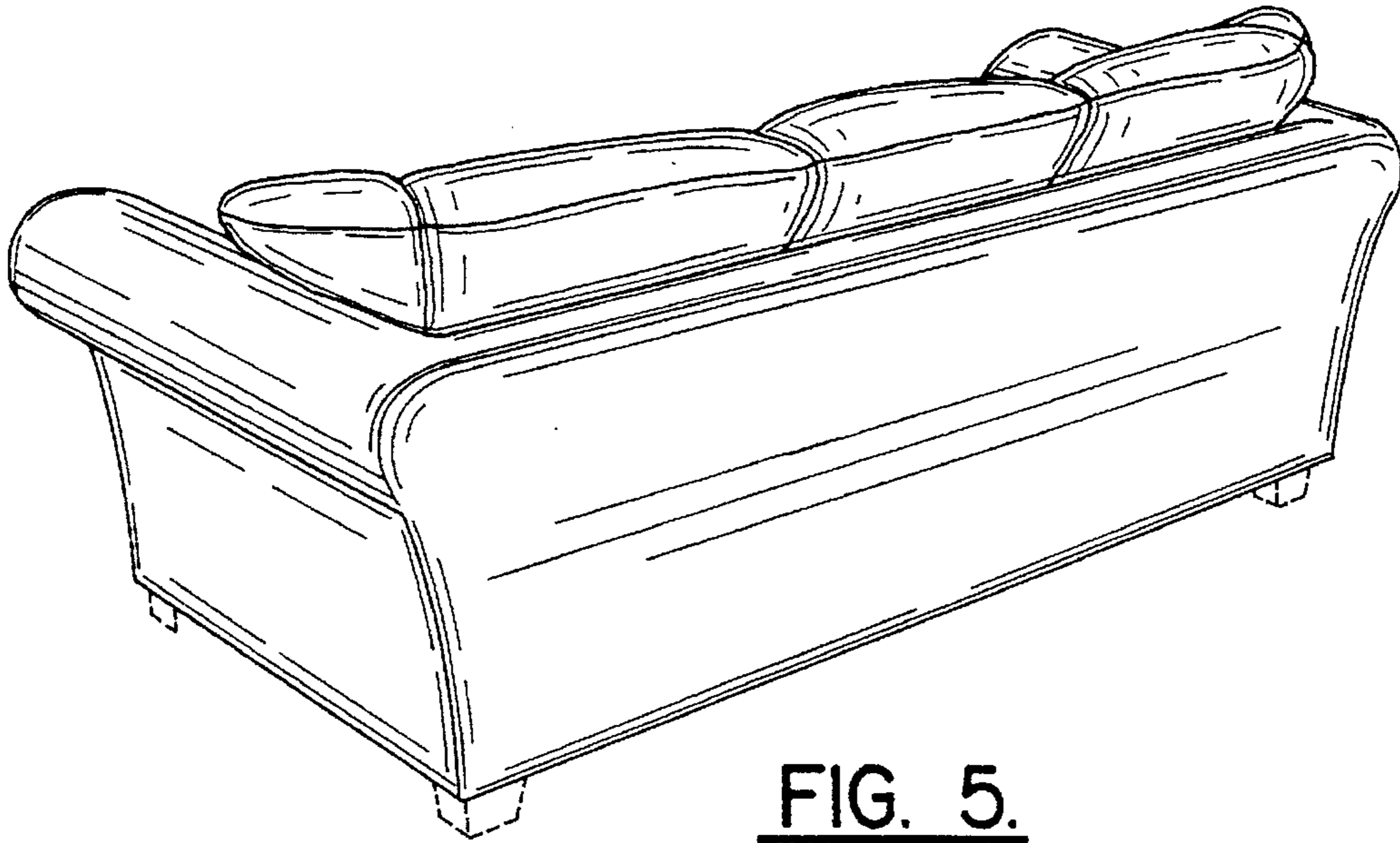

FIG. 5.

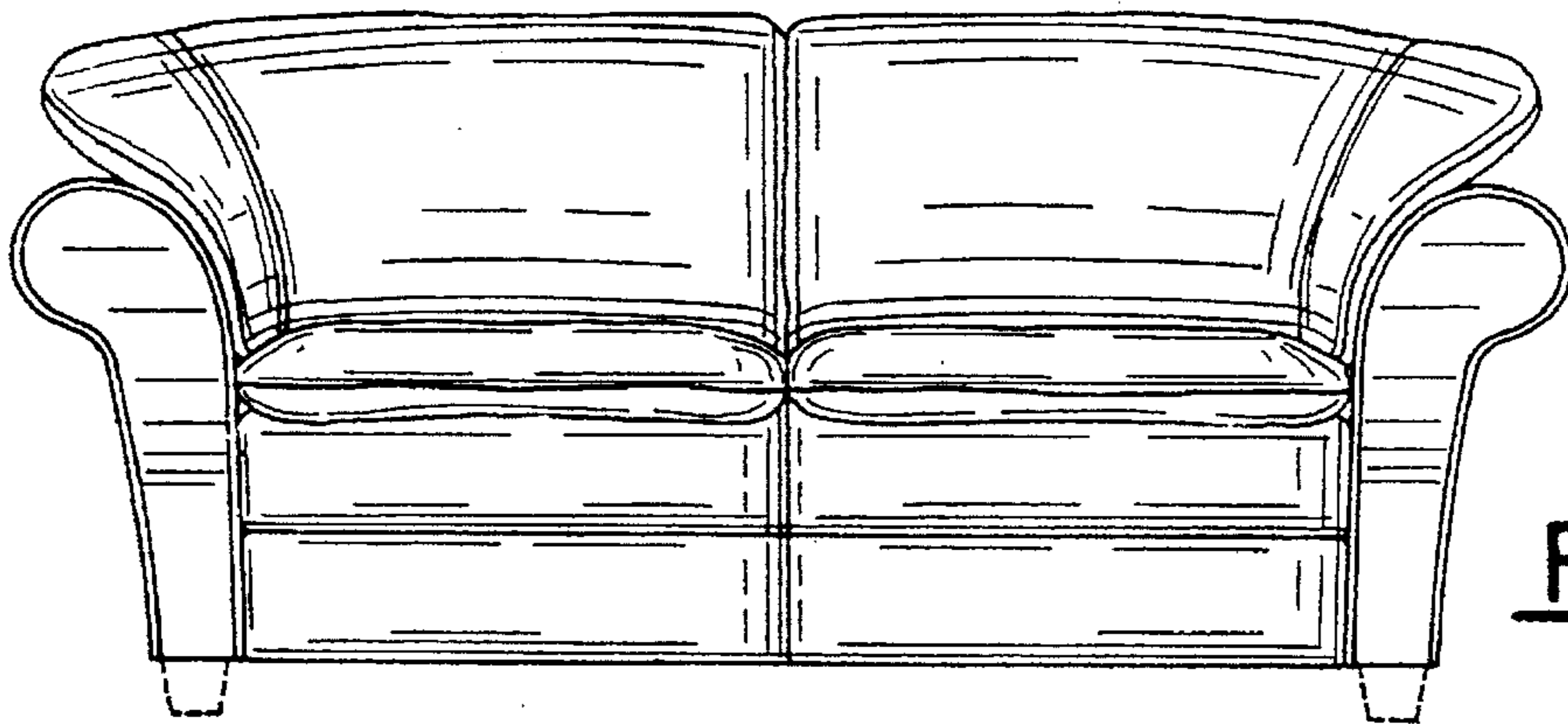

FIG. 6.

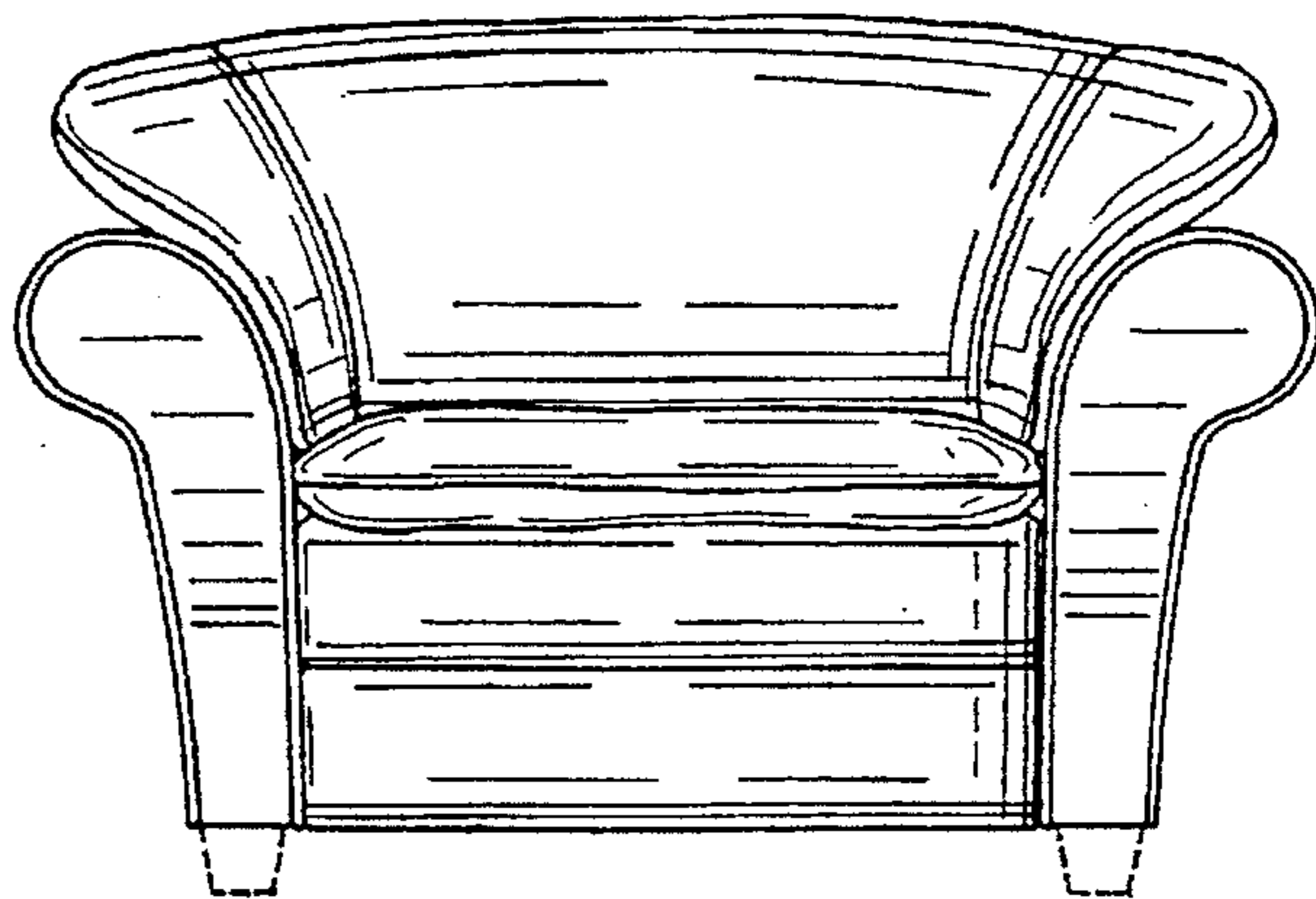

FIG. 7.