



US00D382704S

United States Patent [19]
Petruzzi

[11] **Patent Number: Des. 382,704**
[45] **Date of Patent: **Aug. 26, 1997**

[54] **KEY CHAIN BOX**

[76] Inventor: **Thomas G. Petruzzi**, 5118 Belleville Ave., Orlando, Fla. 32812

[**] Term: **14 Years**

[21] Appl. No.: **53,840**

[22] Filed: **May 14, 1996**

Related U.S. Application Data

[63] Continuation-in-part of Ser. No. 37,046, Apr. 3, 1995, Pat. No. Des. 369,902.

[51] **LOC (6) Cl.** **02-07**

[52] **U.S. Cl.** **D3/207**

[58] **Field of Search** D3/201, 207-212;
D8/347; 70/456 B, 458 R; 40/642, 721,
530

[56] **References Cited**

U.S. PATENT DOCUMENTS

D. 44,524	8/1913	Feeley	D11/80
D. 127,468	5/1941	Steiner	D11/43
D. 203,737	2/1966	Friedman	D3/207
D. 351,049	9/1994	Schlueter	D3/208
D. 358,251	5/1995	Bettis	D3/208
D. 370,558	6/1996	McGinnis	D3/208
1,910,476	5/1933	Rulong	40/642
2,511,651	6/1950	Schlitz	D3/208
2,733,830	4/1956	Ruskin	.	
2,746,081	10/1956	Gershen	.	
3,077,282	2/1963	Eggers	.	
3,111,152	11/1963	Goessling	D3/207
3,285,464	11/1966	Boydman	.	
3,315,796	4/1967	Dreyfuss	.	
3,381,844	5/1968	Sieve	.	
3,405,836	10/1968	Regis	.	
3,642,939	2/1972	Gossard	40/721
4,109,821	8/1978	Lutz	.	
4,302,866	12/1981	Irvin	.	
4,401,312	8/1983	Parker	.	
4,431,114	2/1984	Kleinfeld	.	
5,096,084	3/1992	Wells	.	

Primary Examiner—Ralf Seifert

Attorney, Agent, or Firm—Allen, Dyer, Doppelt, Milbrath & Gilchrist, P.A.

[57] **CLAIM**

The ornamental design for a key chain box, as shown and described.

DESCRIPTION

FIG. 1 is a top, left perspective view of a key chain box showing my new design;

FIG. 2 is a top plan view thereof;

FIG. 3 is a bottom plan view thereof;

FIG. 4 is a front elevational view thereof;

FIG. 5 is a rear elevational view thereof;

FIG. 6 is a left side elevational view thereof;

FIG. 7 is a right side elevational view thereof;

FIG. 8 is a top, left perspective view of a second embodiment of FIG. 1, the only difference being acceptance of alternate key chain tab configurations;

FIG. 9 is a top plan view of FIG. 8;

FIG. 10 is a bottom plan view of FIG. 8;

FIG. 11 is a front elevational view of FIG. 8;

FIG. 12 is a rear elevational view of FIG. 8;

FIG. 13 is a left side elevational view of FIG. 8;

FIG. 14 is a right side elevational view of FIG. 8;

FIG. 15 is a top, left perspective view of a third embodiment of FIG. 1, the only difference being a single hinge;

FIG. 16 is a top plan view of FIG. 15;

FIG. 17 is a bottom plan view of FIG. 15;

FIG. 18 is a front elevational view of FIG. 15;

FIG. 19 is a rear elevational view of FIG. 15;

FIG. 20 is a left side elevational view of FIG. 15; and,

FIG. 21 is a right side elevational view of FIG. 15.

The broken line showing of a chain in FIGS. 1, 8 and 15 is for illustrative purposes only and forms no part of the claimed design. Further, the broken line shown the chain tab of FIGS. 8-12 is for illustrative purposes and forms no part of the claimed design for the alternate embodiment.

1 Claim, 3 Drawing Sheets

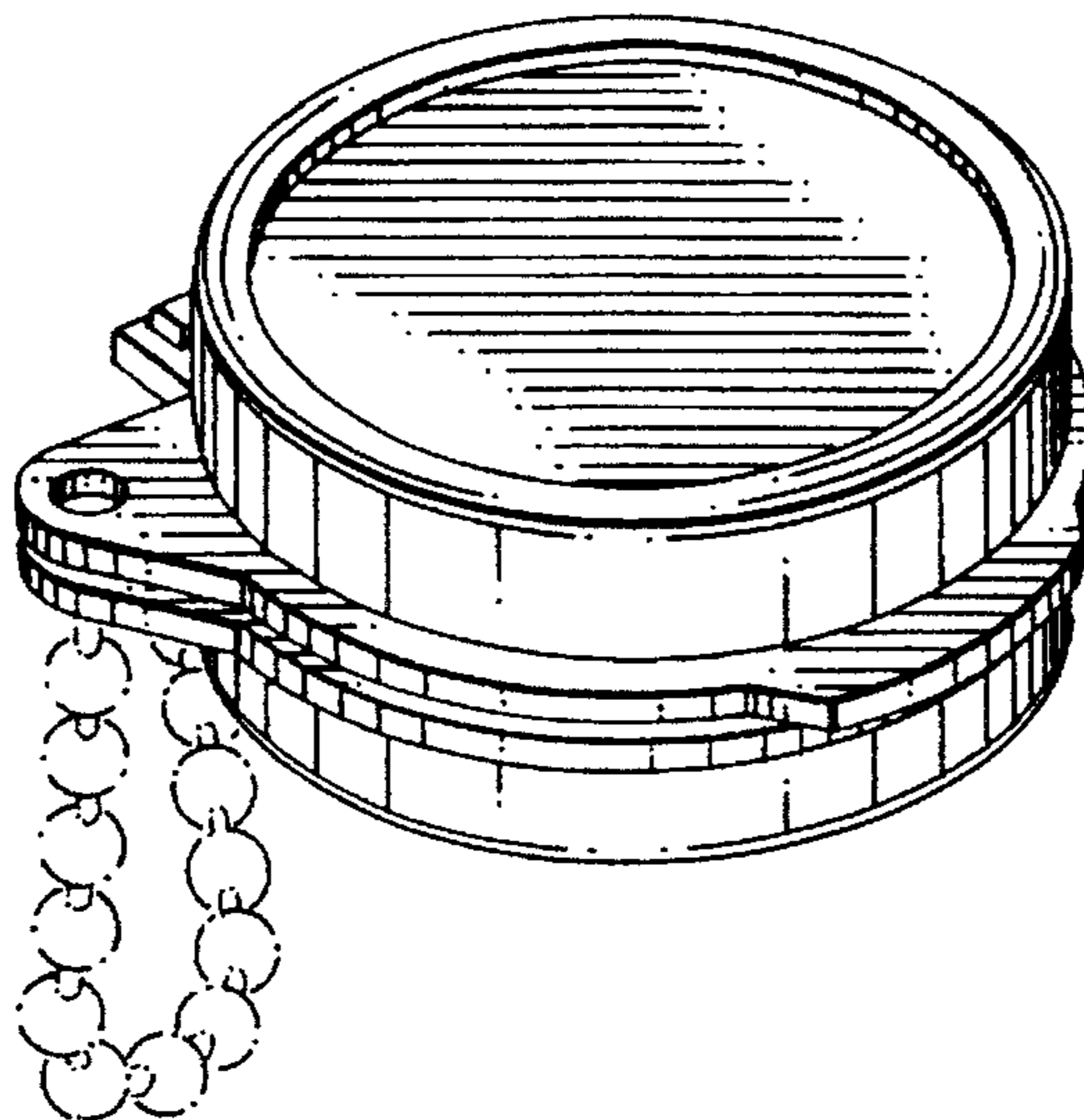

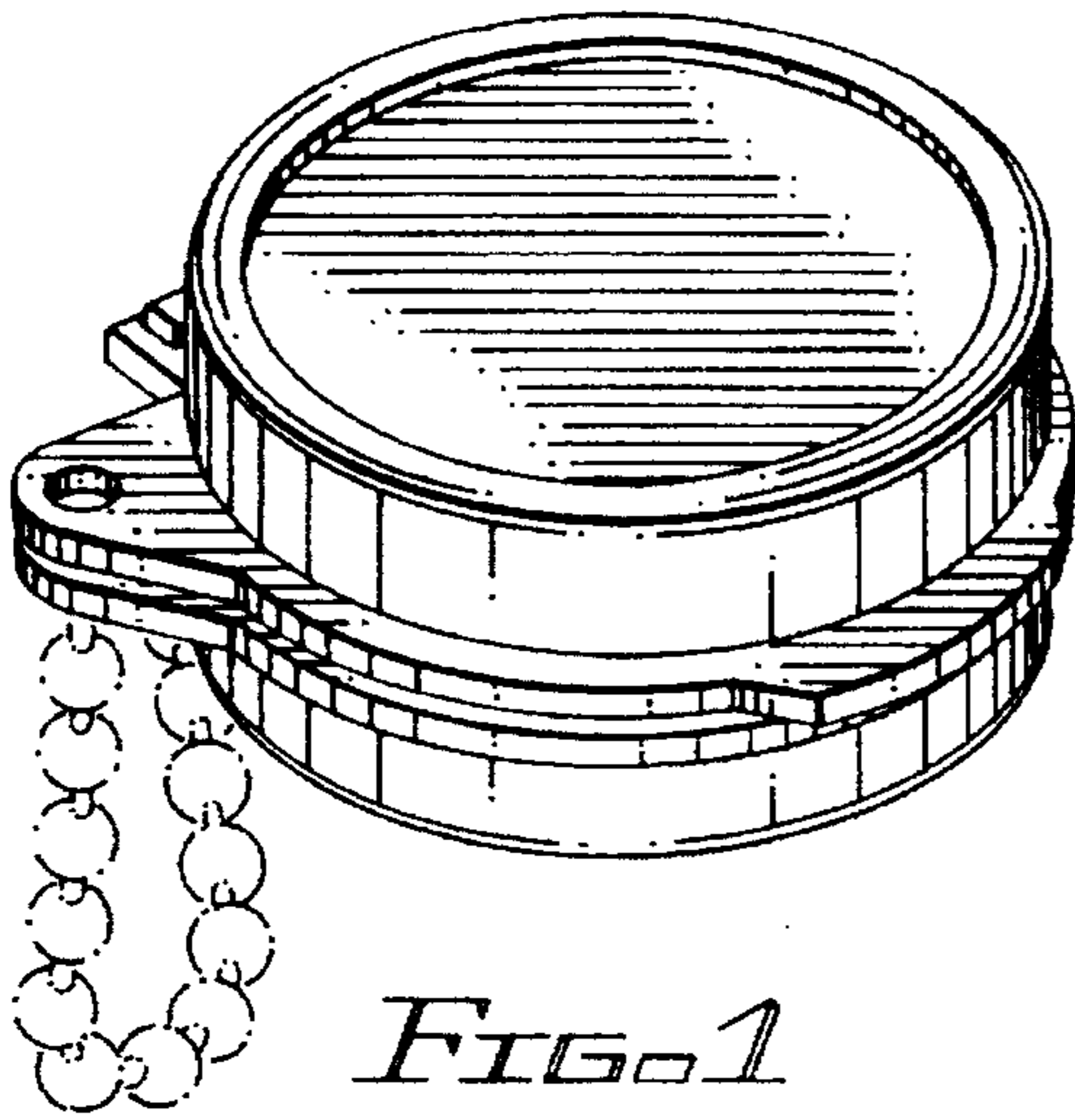

FIG. 1

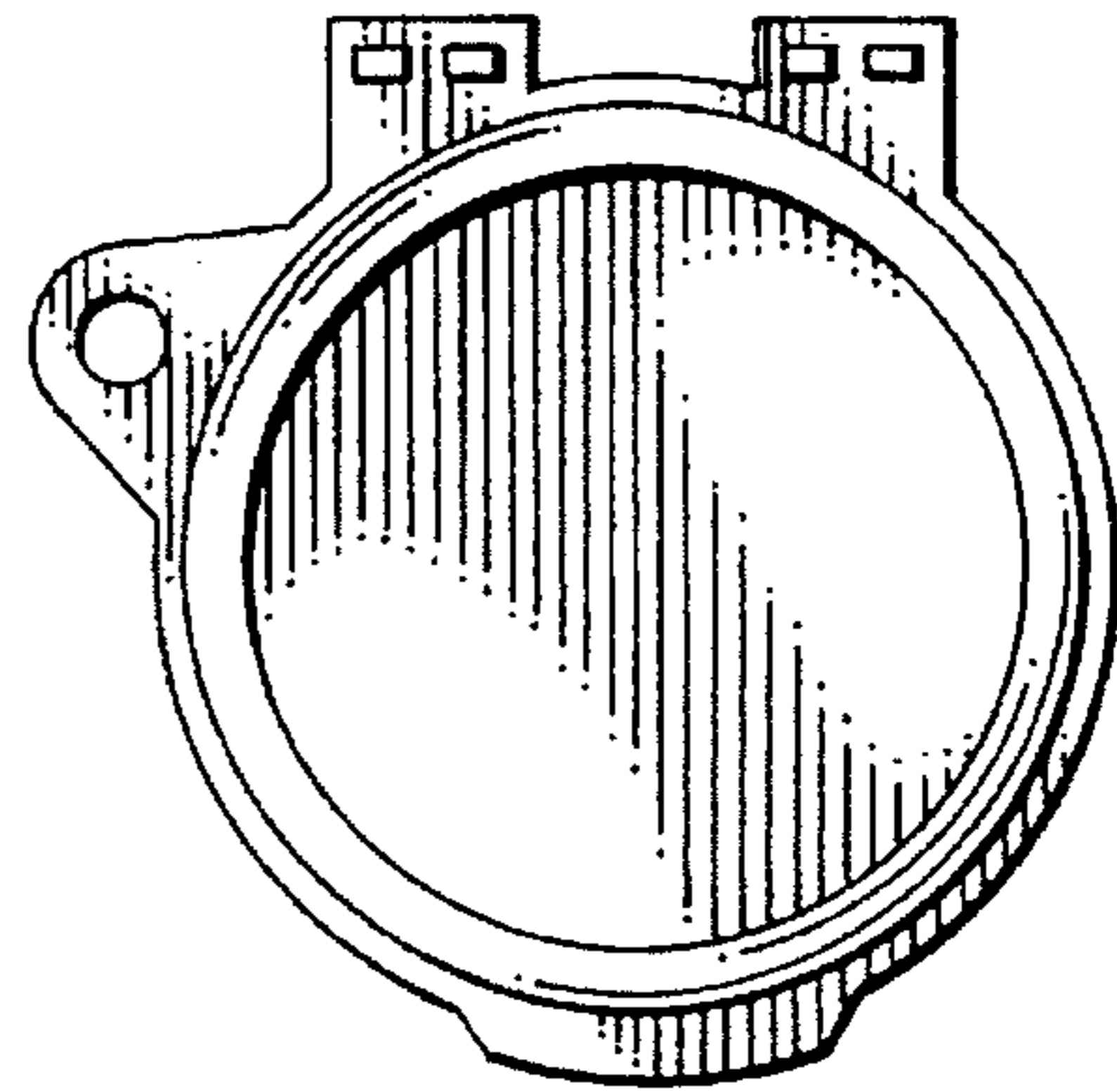

FIG. 2

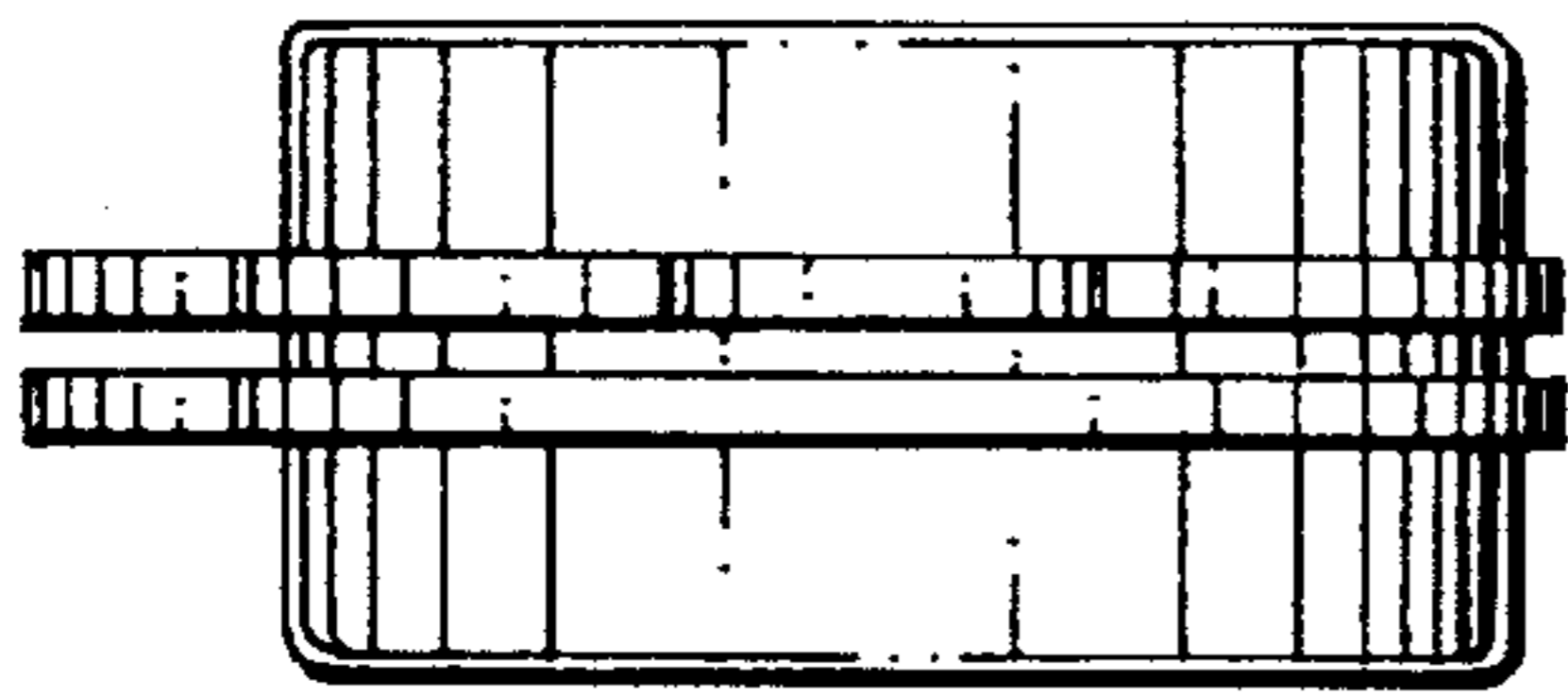

FIG. 4

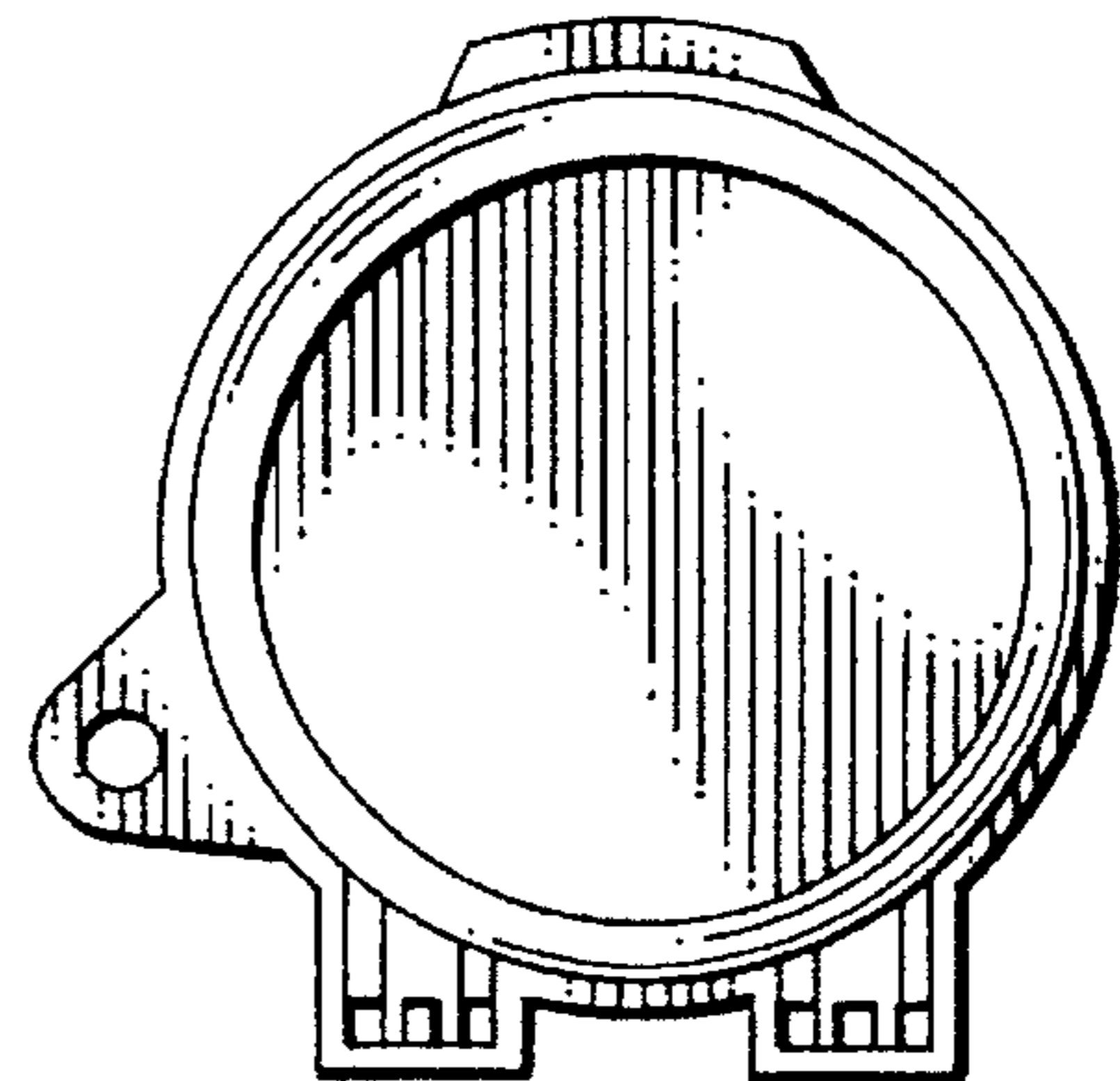

FIG. 3

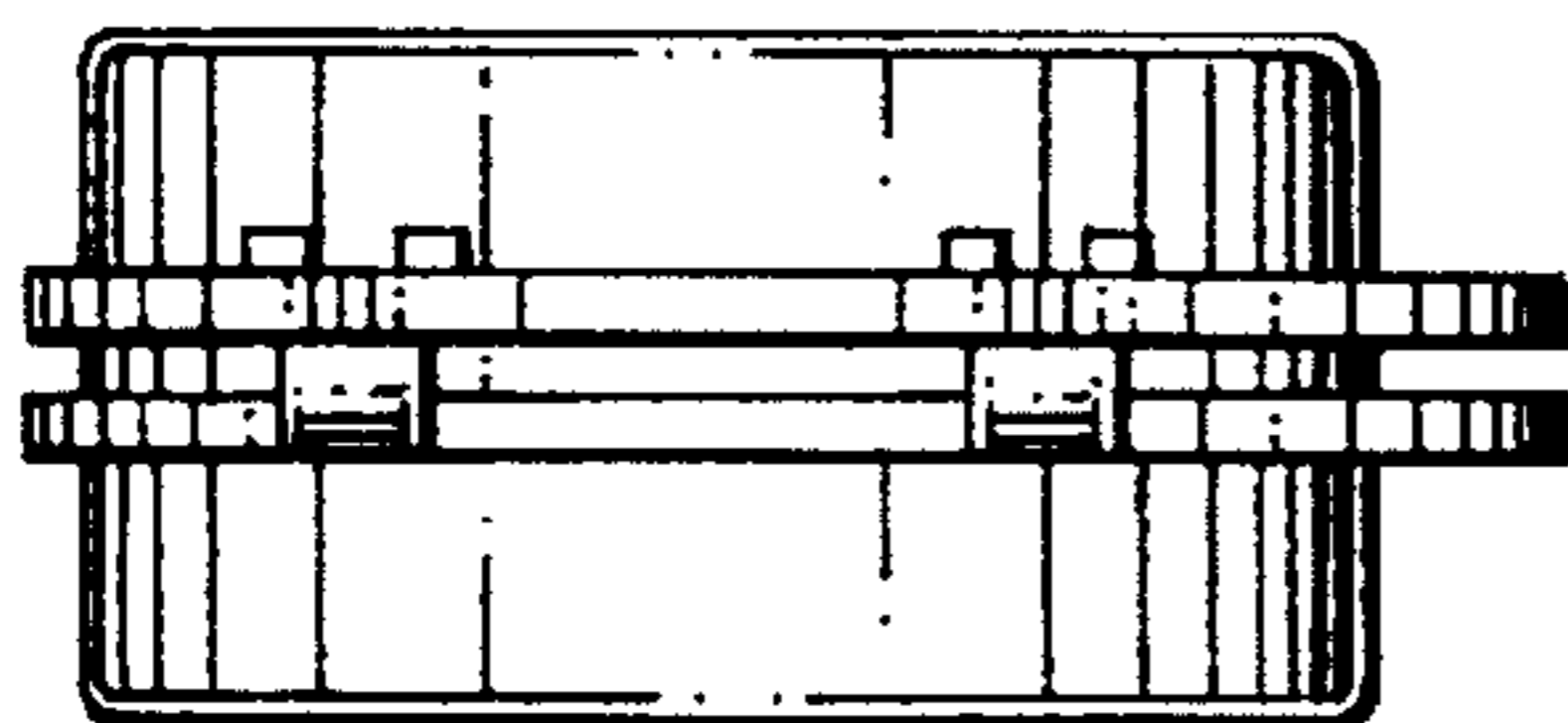

FIG. 5

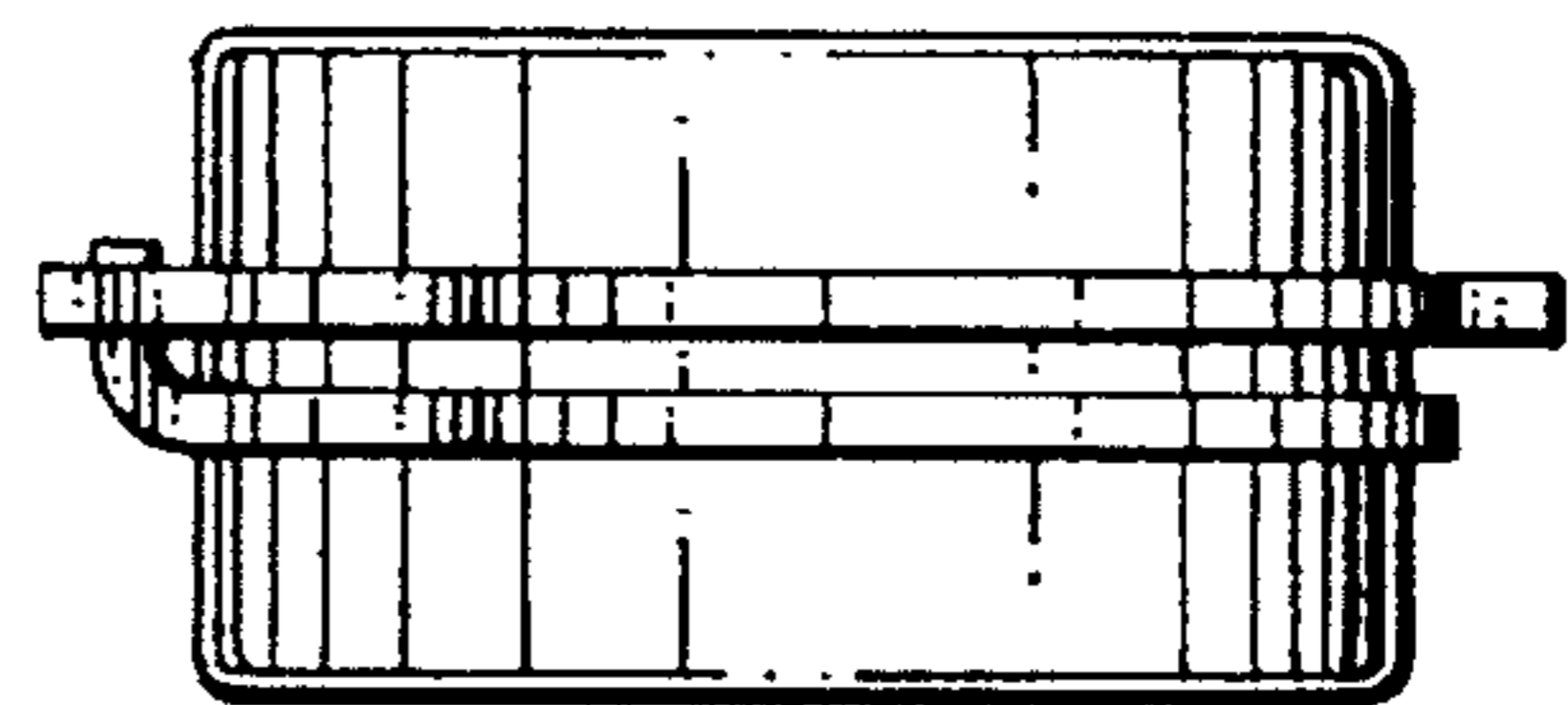

FIG. 6

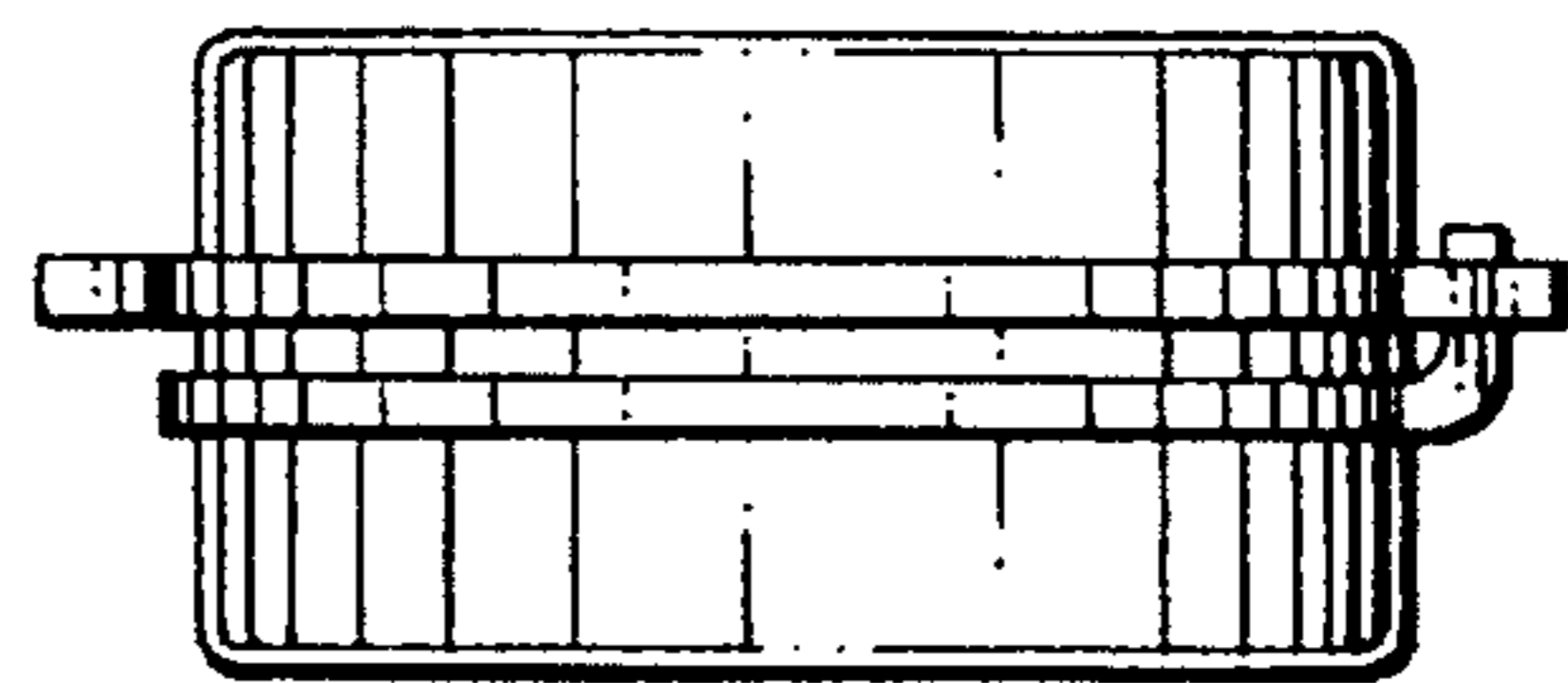

FIG. 7

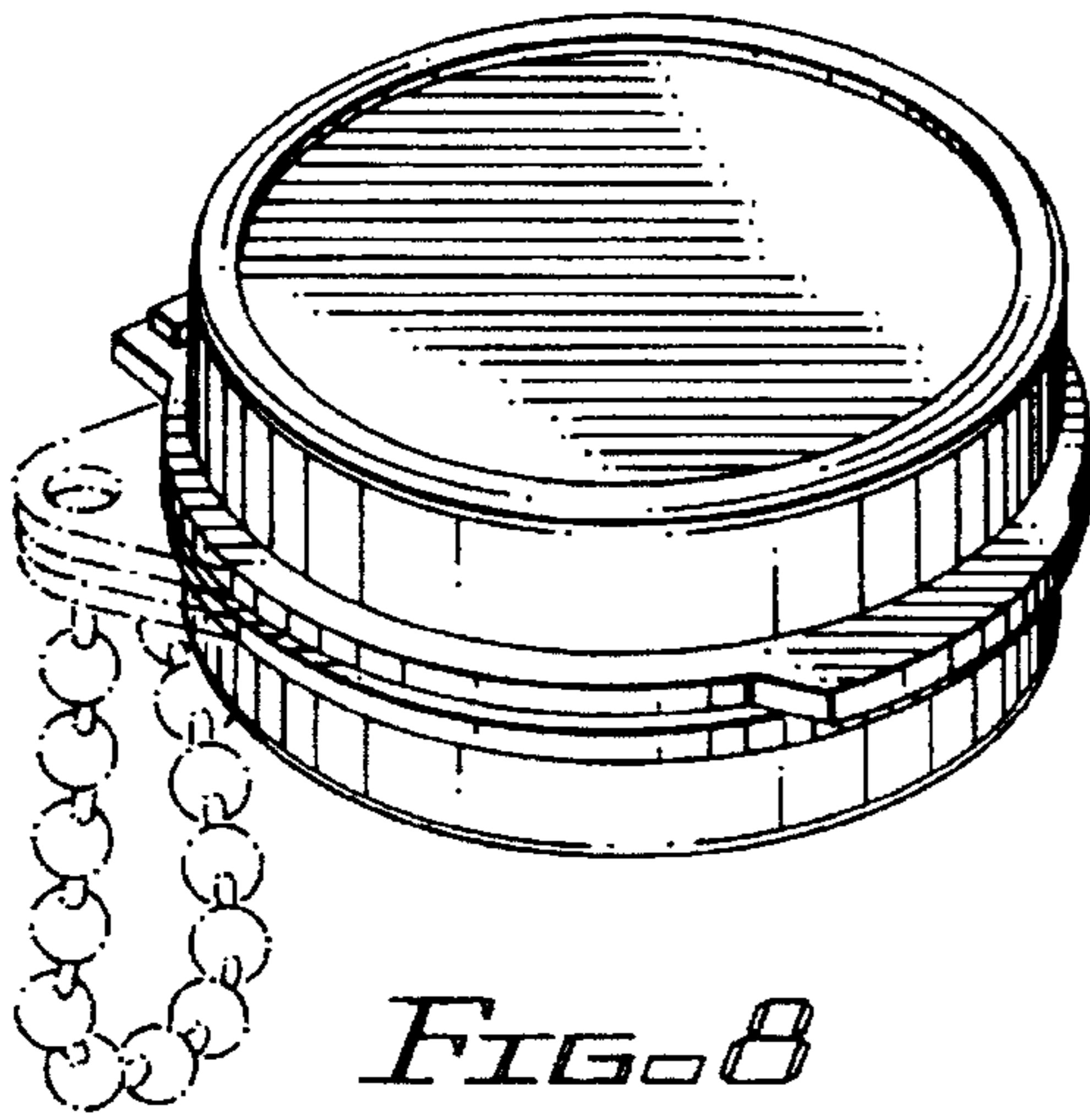

FIG. 8

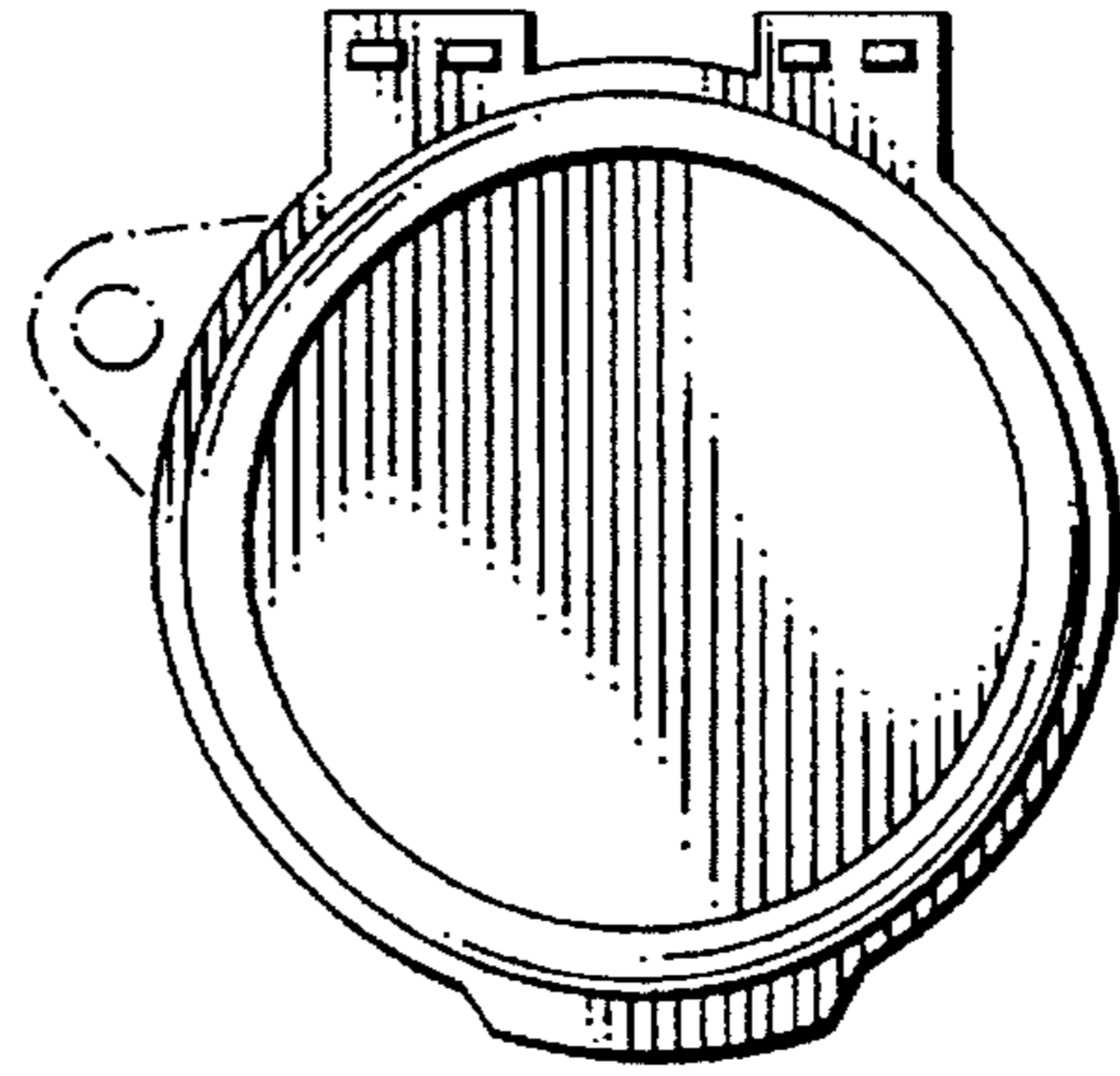

FIG. 9

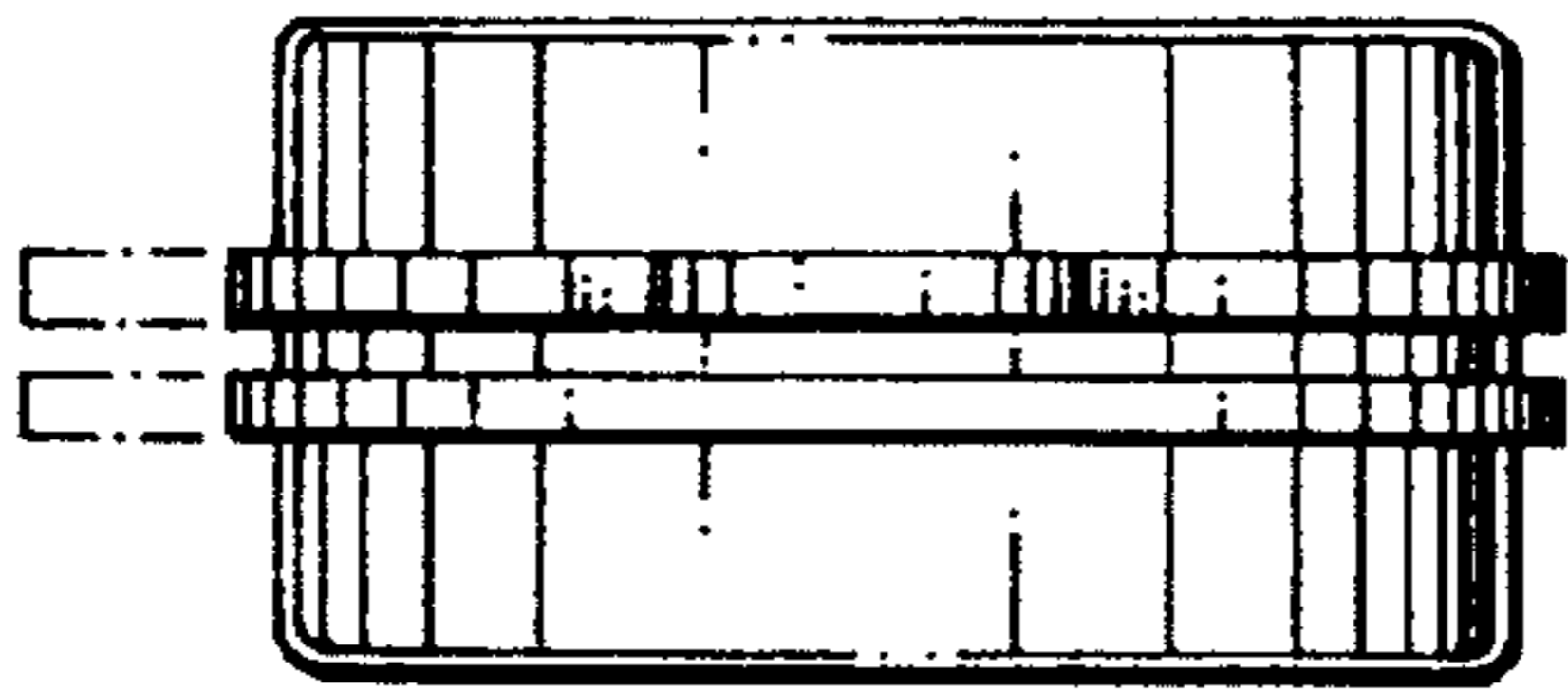

FIG. 11

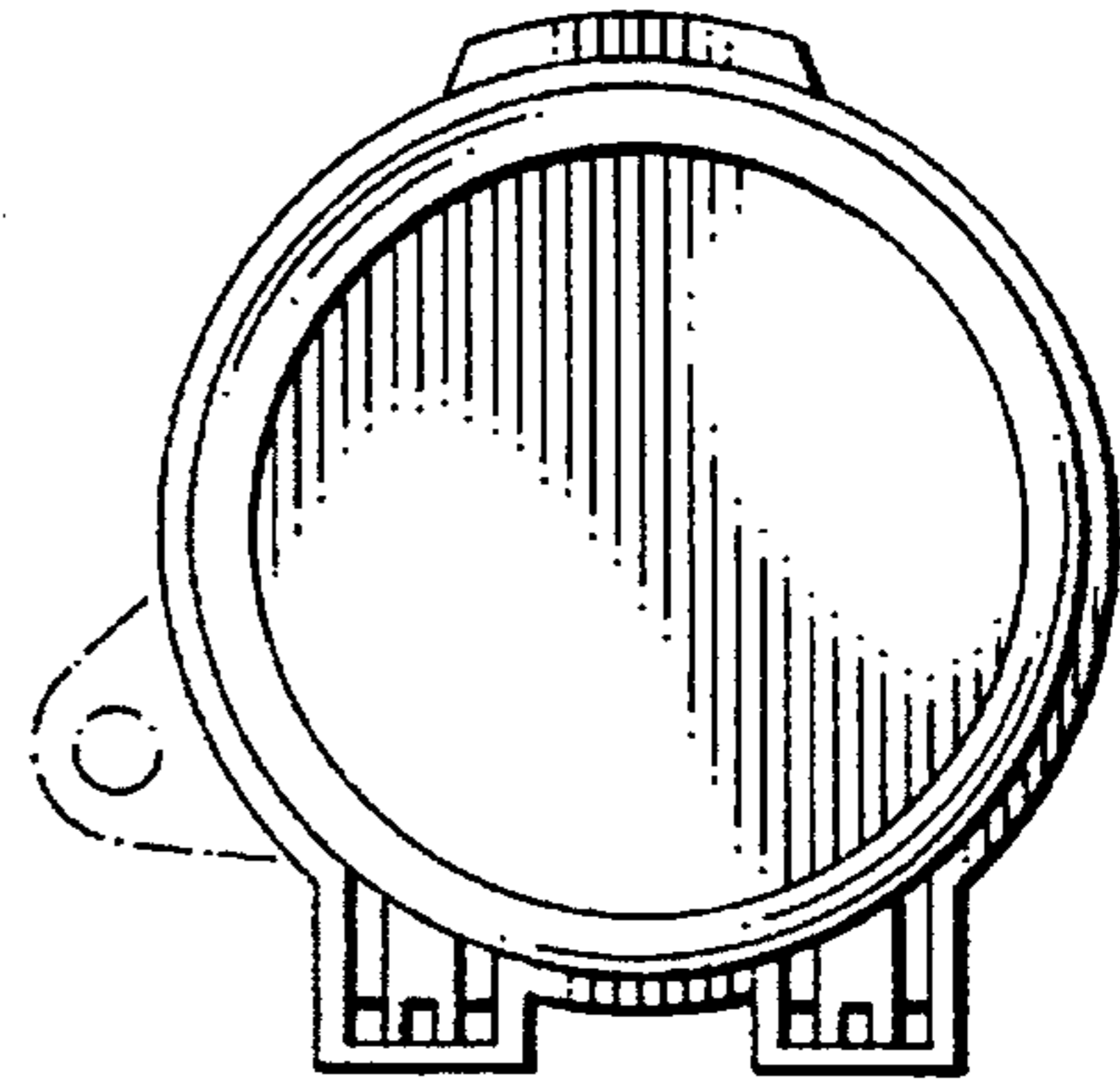

FIG. 10

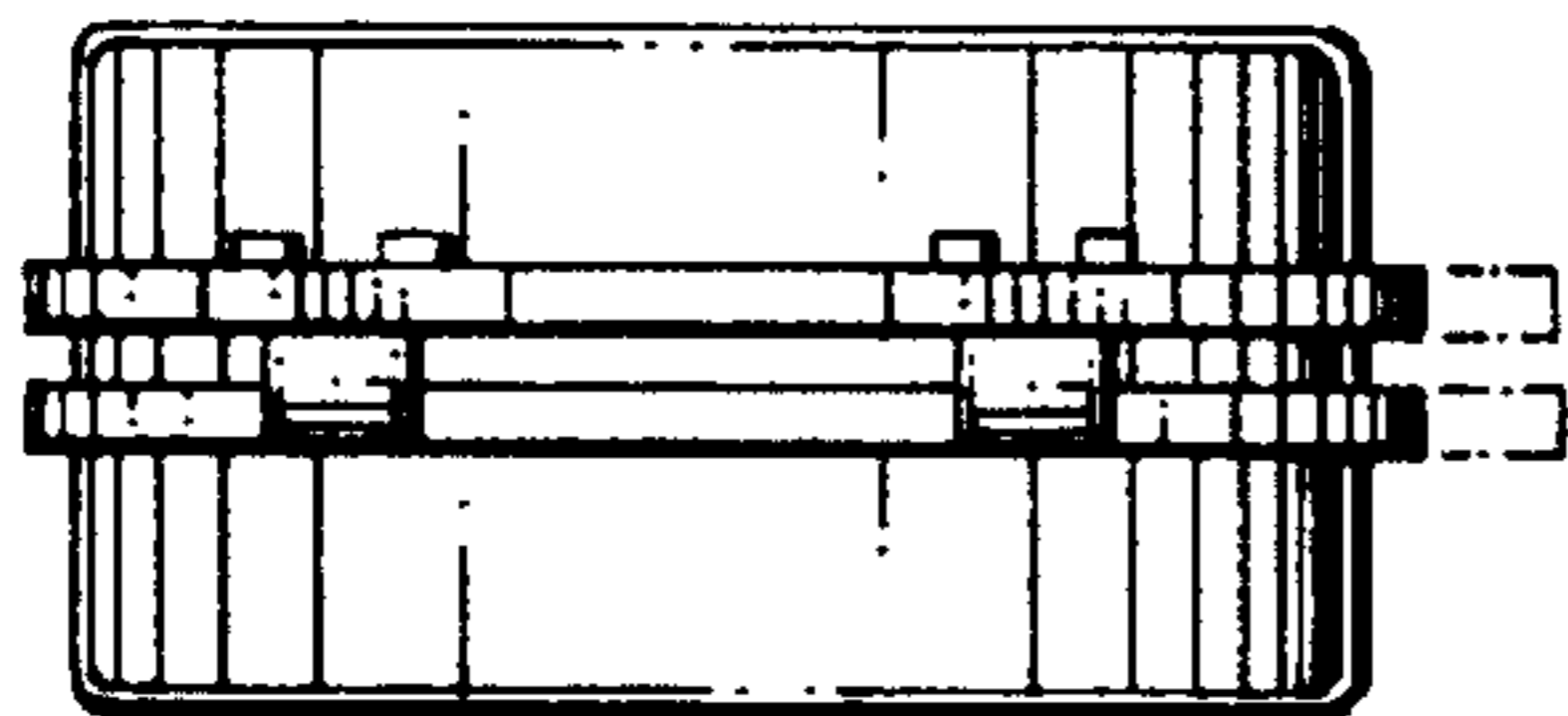

FIG. 12

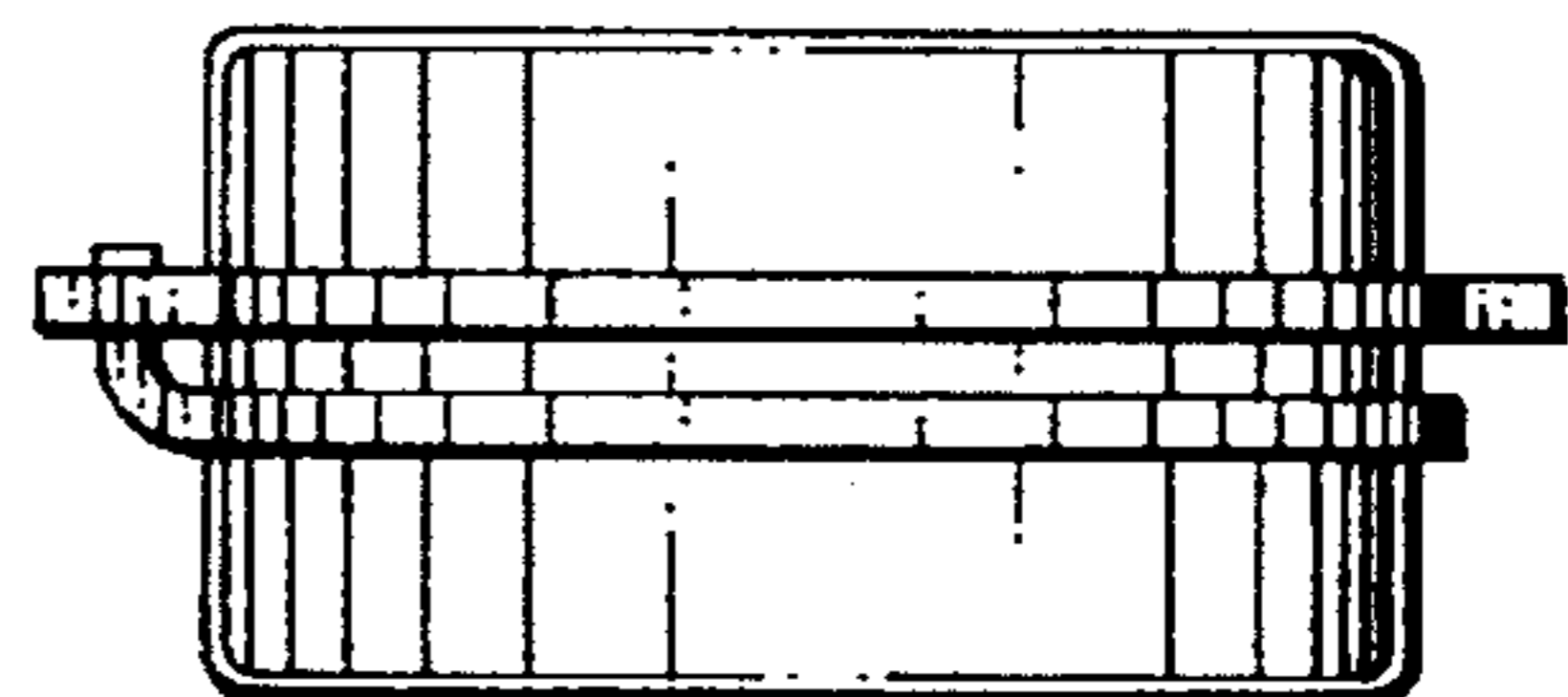

FIG. 13

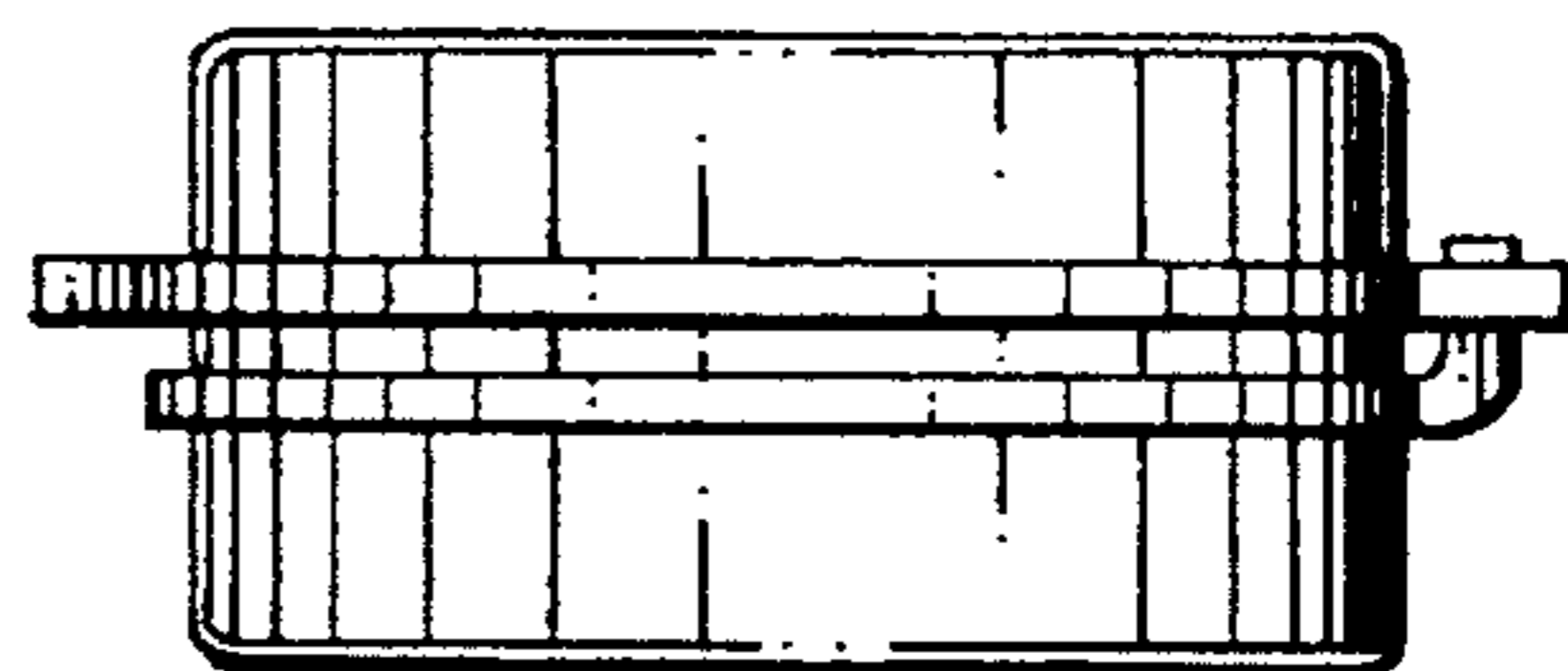

FIG. 14

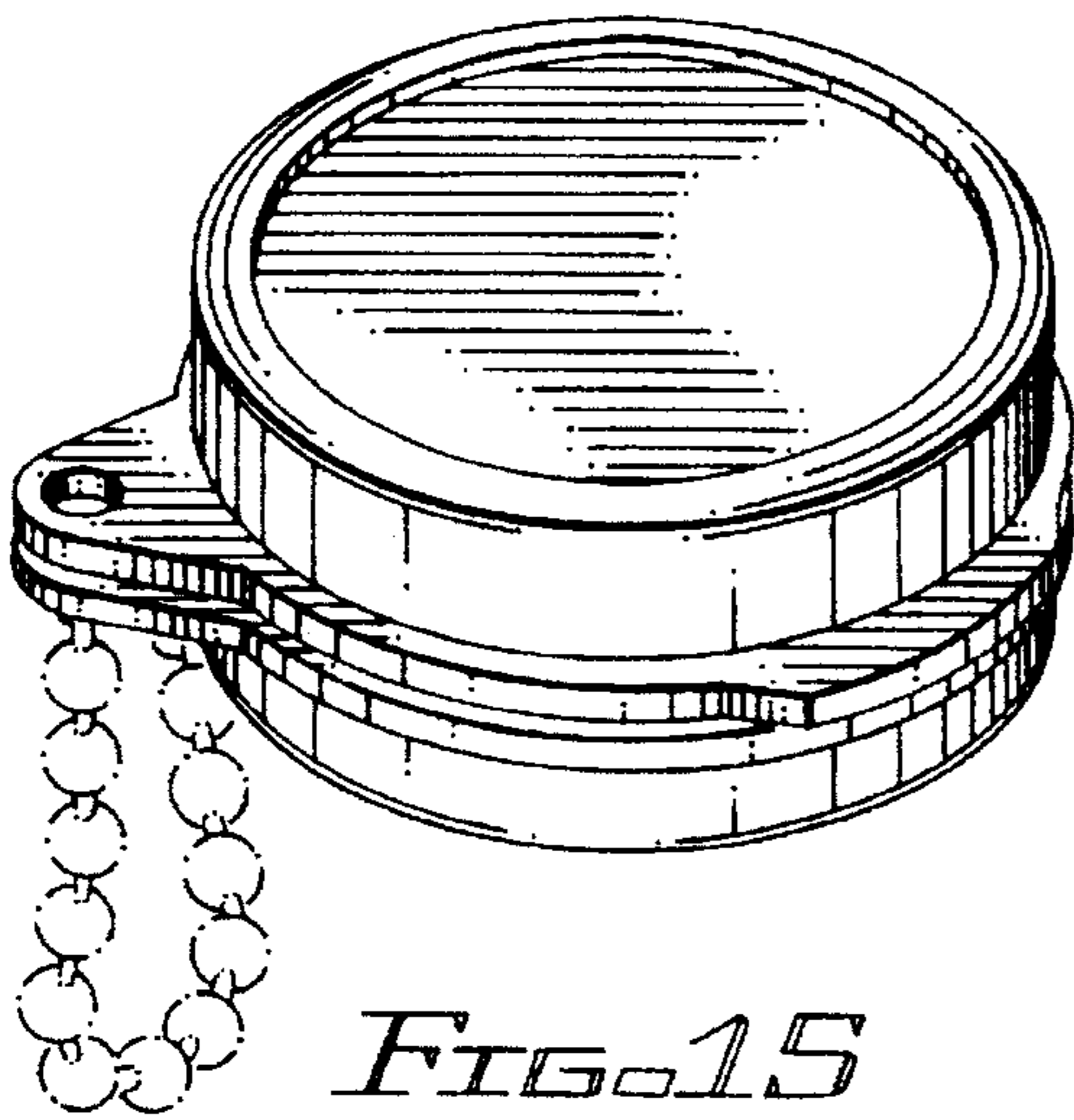

FIG. 15

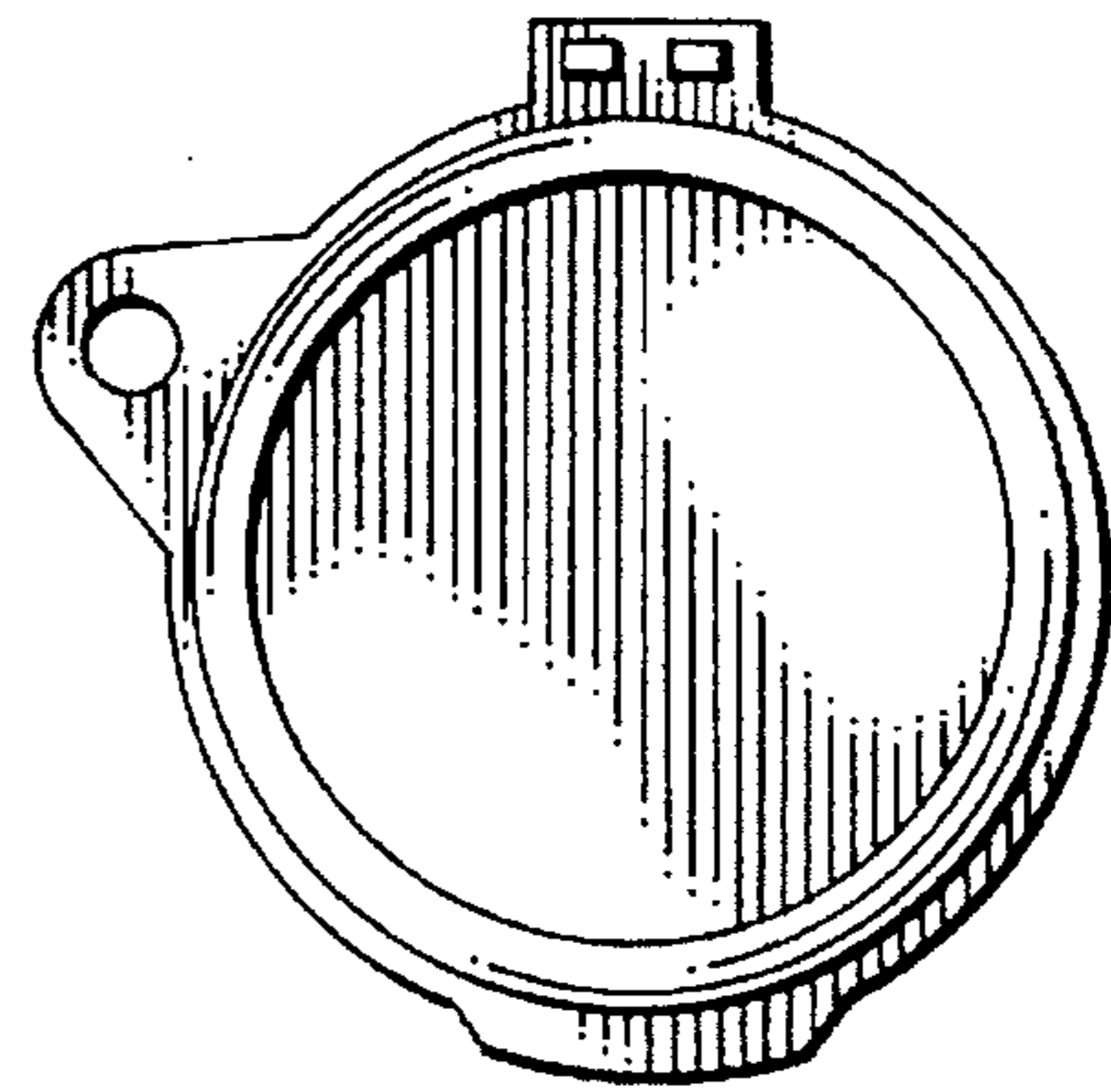

FIG. 16

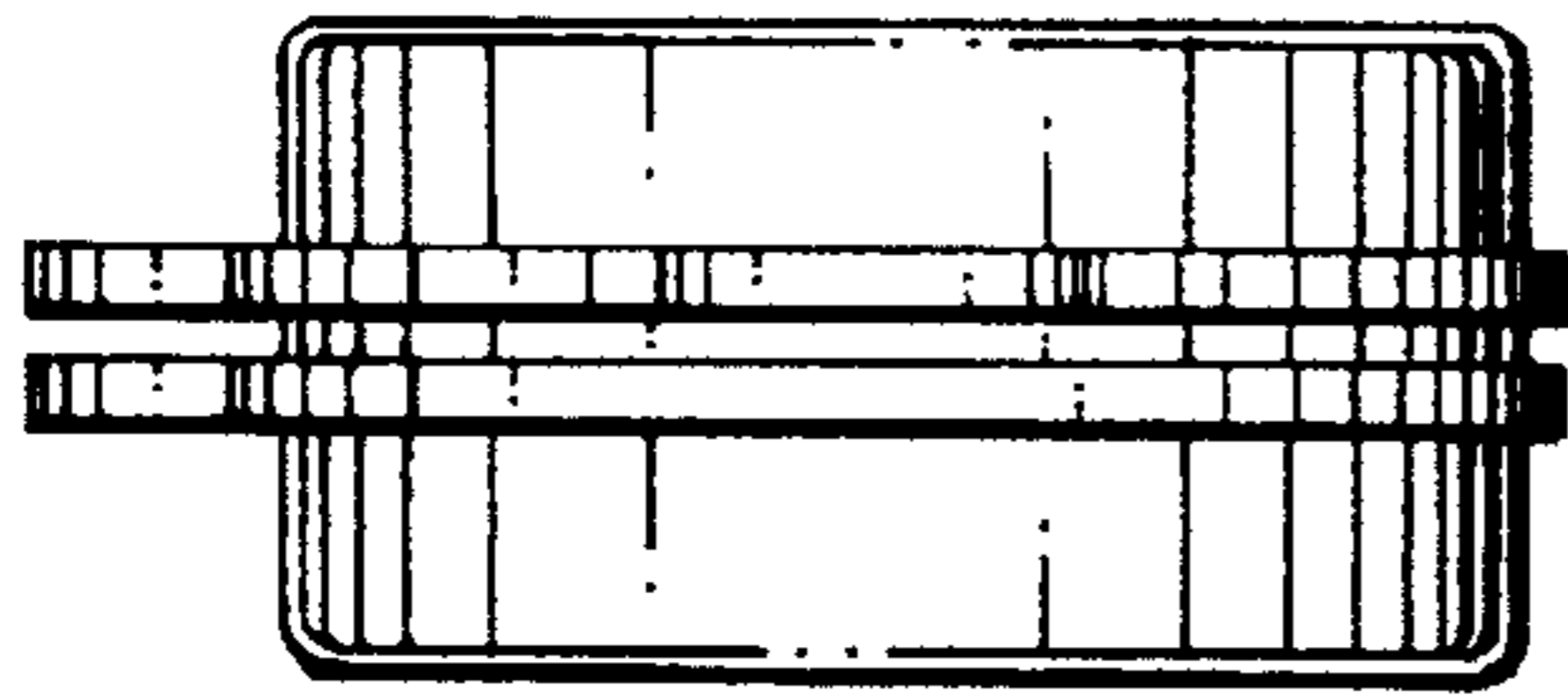

FIG. 18

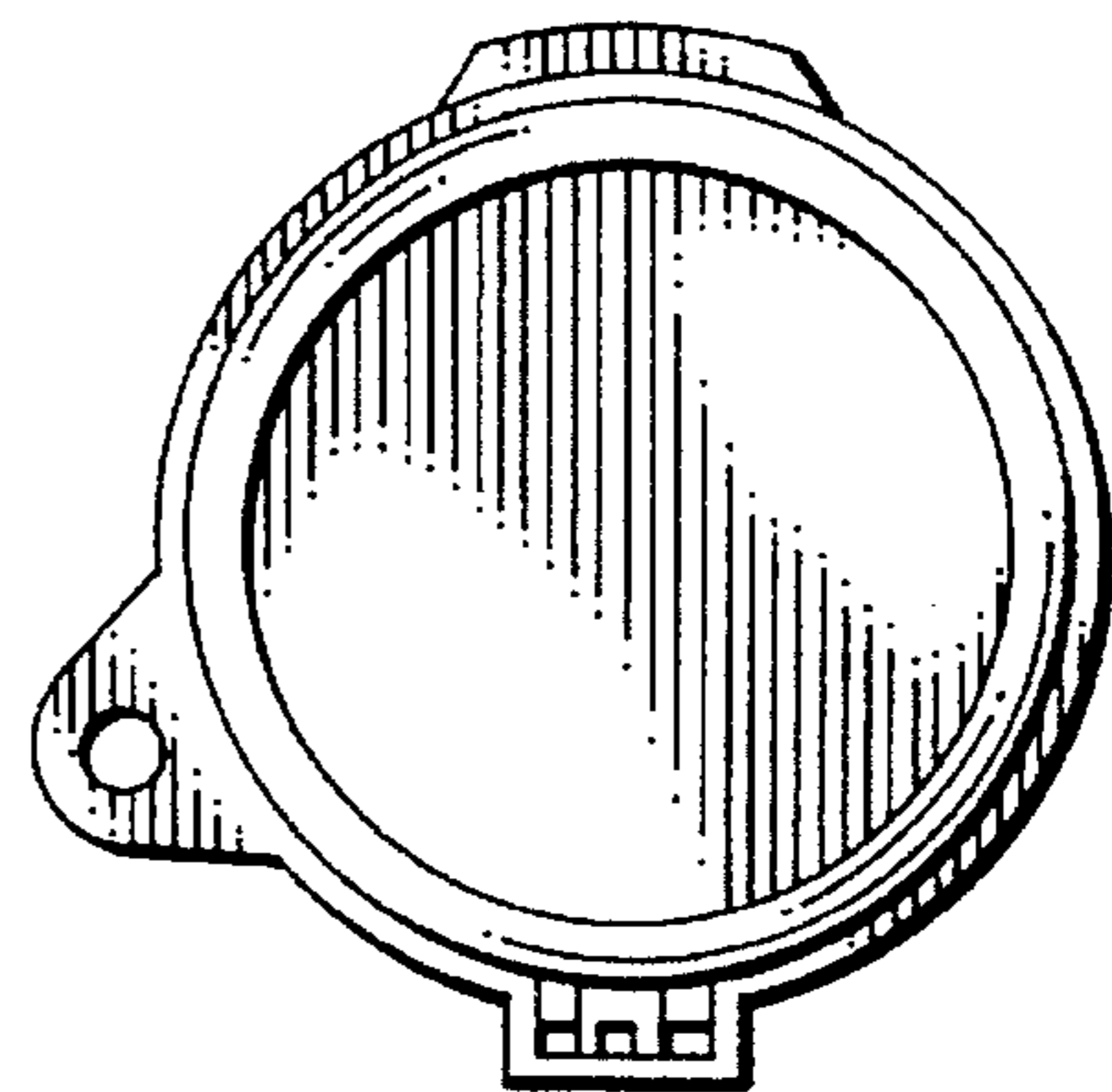

FIG. 17

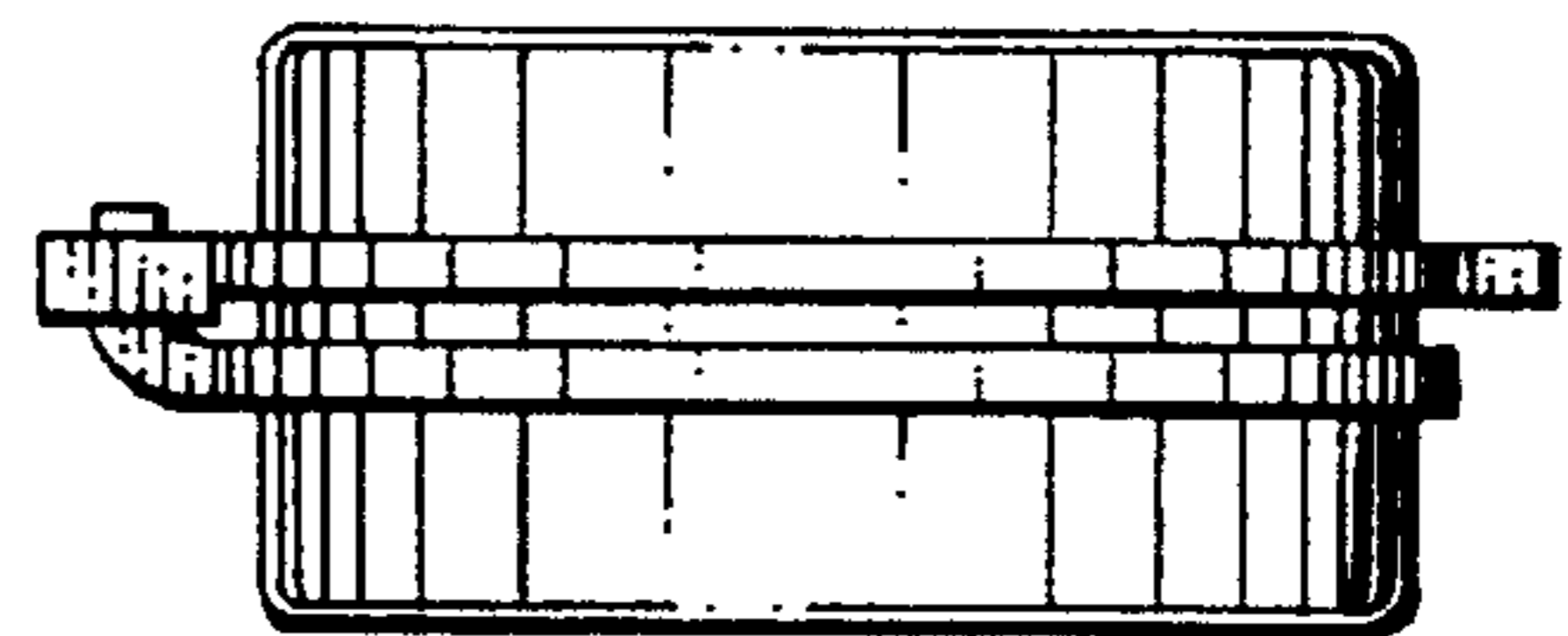

FIG. 20

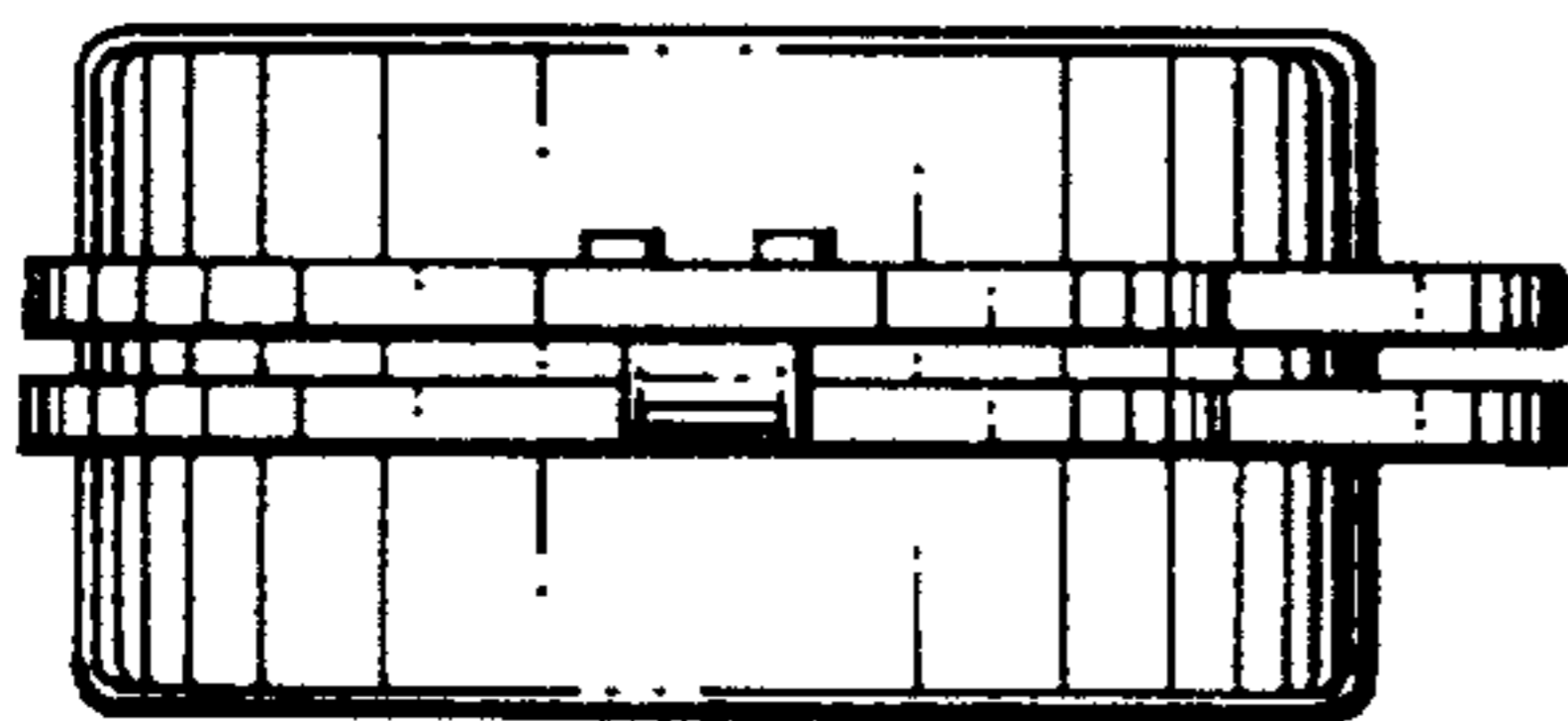

FIG. 19

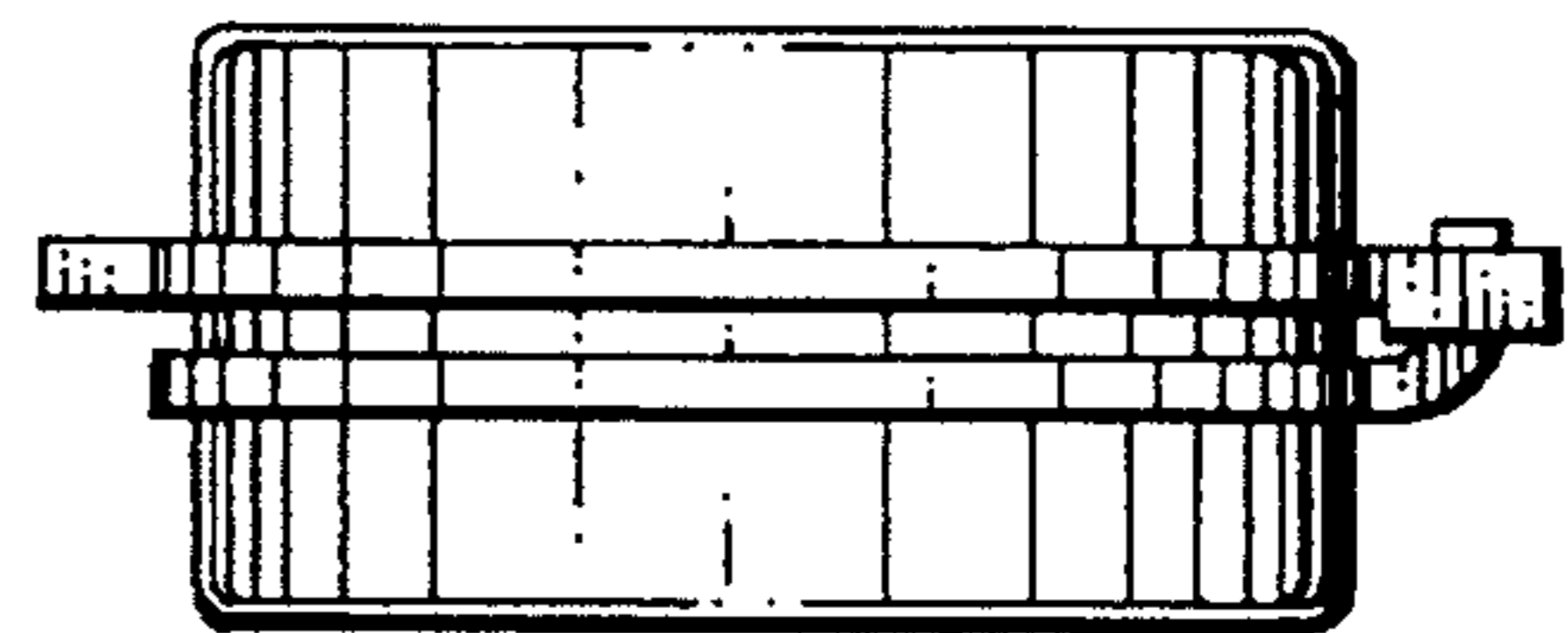

FIG. 21