



US00D382670S

United States Patent [19]

[11] Patent Number: **Des. 382,670**

Sayre

[45] Date of Patent: ****Aug. 19, 1997**

[54] **REFLECTIVE SAFETY VEST FOR BICYCLIST AND BACKPACKERS**

Primary Examiner—Ruth McInroy
Attorney, Agent, or Firm—C. A. Phillips; Joseph H. Beumer

[76] Inventor: **R. Scott Sayre**, 15 High Meadow Dr.,
Lexington, Va. 24450

[57] **CLAIM**

[**] Term: **14 Years**

The ornamental design for a reflective safety vest for bicyclists and backpackers, as shown and described.

[21] Appl. No.: **53,706**

DESCRIPTION

[22] Filed: **Apr. 26, 1996**

FIG. 1 is a front perspective view of a reflective safety vest for bicyclists and backpackers showing my new design; FIG. 2 is a rear perspective view thereof, the bicyclist shown in broken lines is for illustrative purposes only and forms no part of the claimed design; FIG. 3 is a rear perspective view thereof, the backpacker shown in broken lines is for illustrative purposes only and forms no part of the claimed design; FIG. 4 is a front elevational view thereof; FIG. 5 is a rear elevational view thereof; FIG. 6 is a right side elevational view thereof, the left side being a mirror image; FIG. 7 is a top plan view thereof; and FIG. 8 is a bottom plan view thereof.

[51] LOC (6) Cl. **02-02**

[52] U.S. Cl. **D29/101**

[58] Field of Search D29/100-101;
2/2, 44-45, 92, 102; 362/108; D2/829

[56] **References Cited**

U.S. PATENT DOCUMENTS

D. 273,818	5/1984	Spencer	D29/101
D. 277,808	3/1985	Nichols	D29/101
D. 280,860	10/1985	Monferrato	D29/101
D. 370,744	6/1996	Roberson et al.	D29/101
5,070,436	12/1991	Alexander et al.	D29/100
5,249,106	9/1993	Barnes et al.	D29/100
5,424,922	6/1995	Wise	D29/100

1 Claim, 3 Drawing Sheets

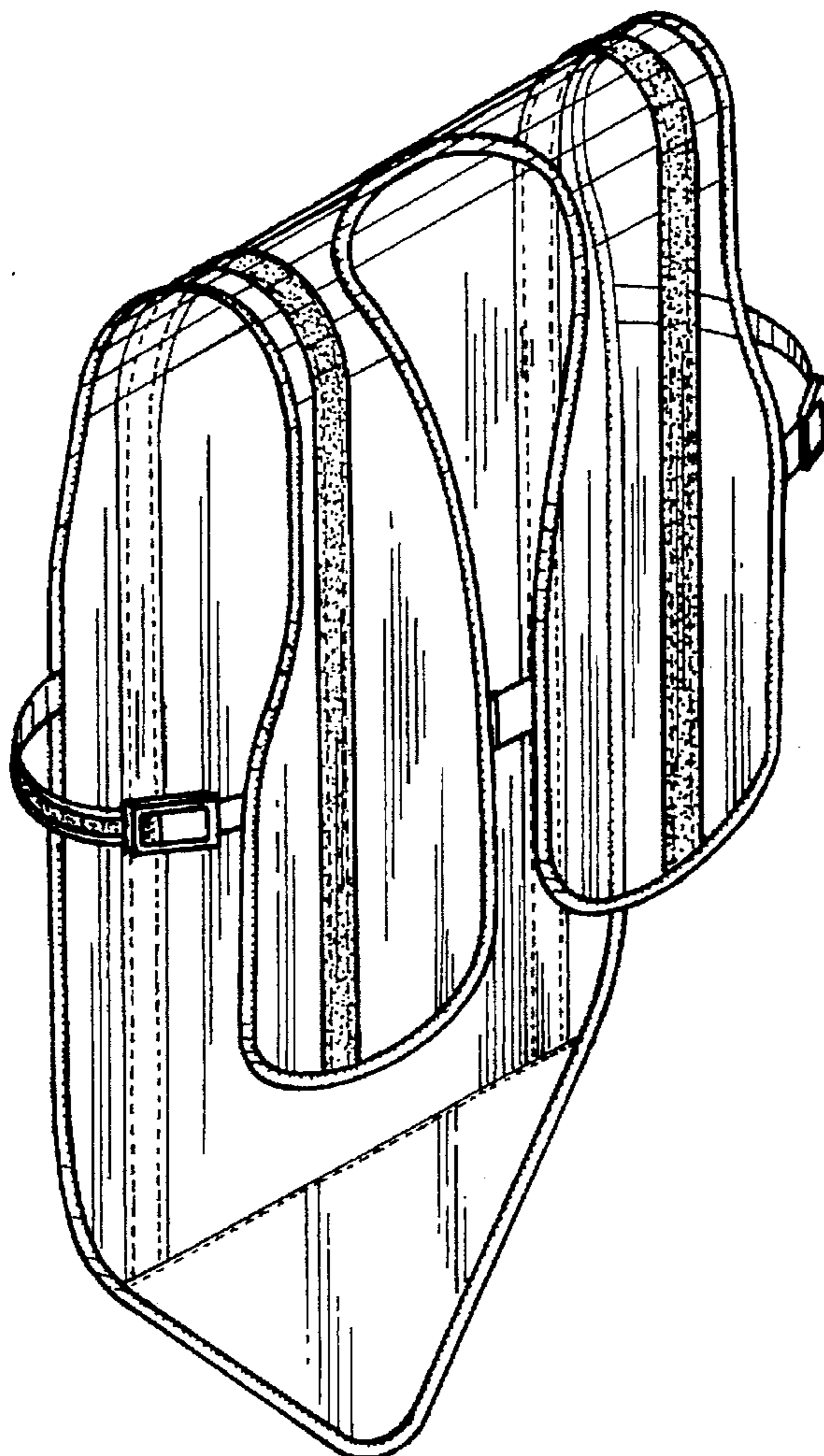

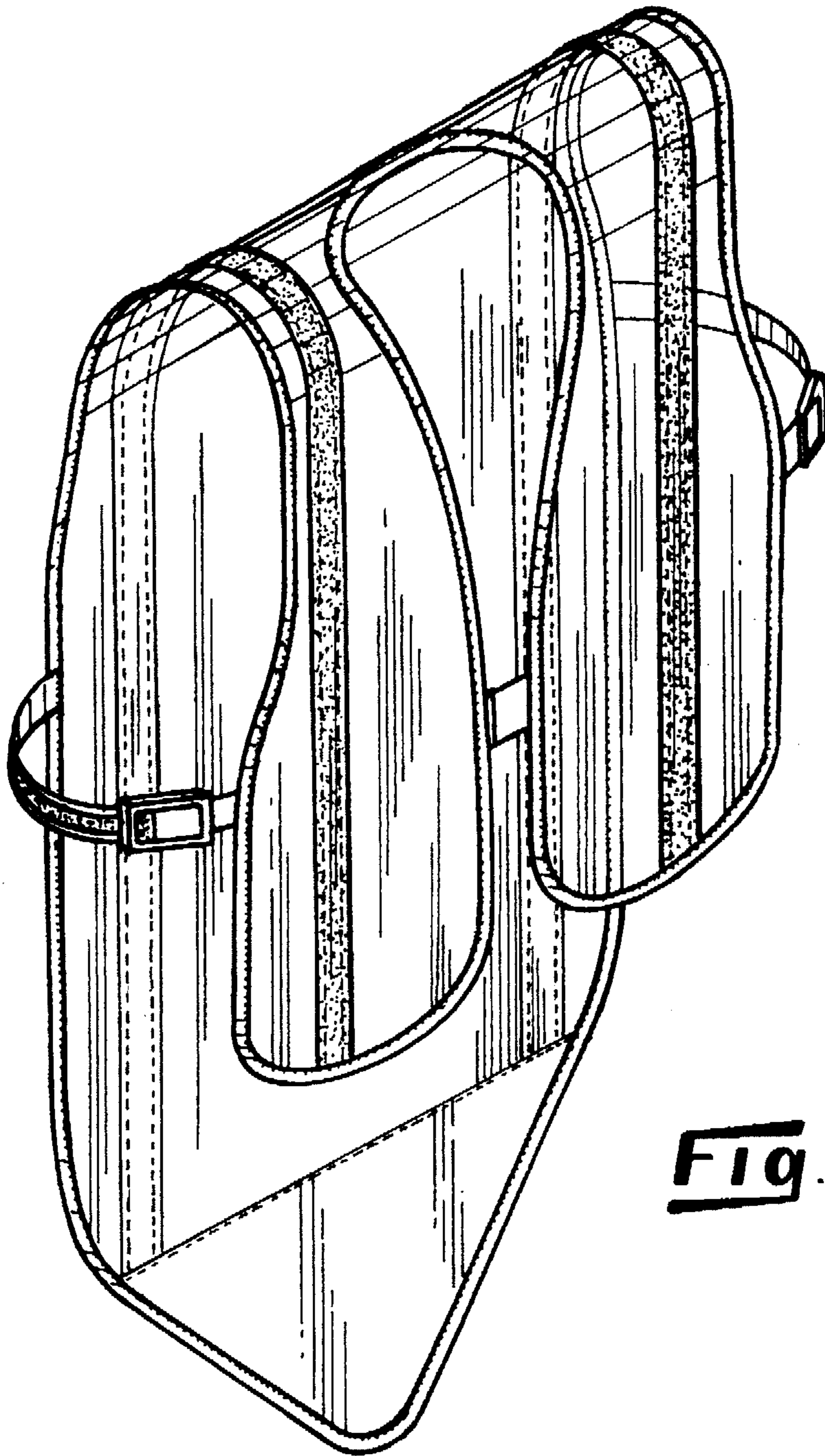

Fig. 1

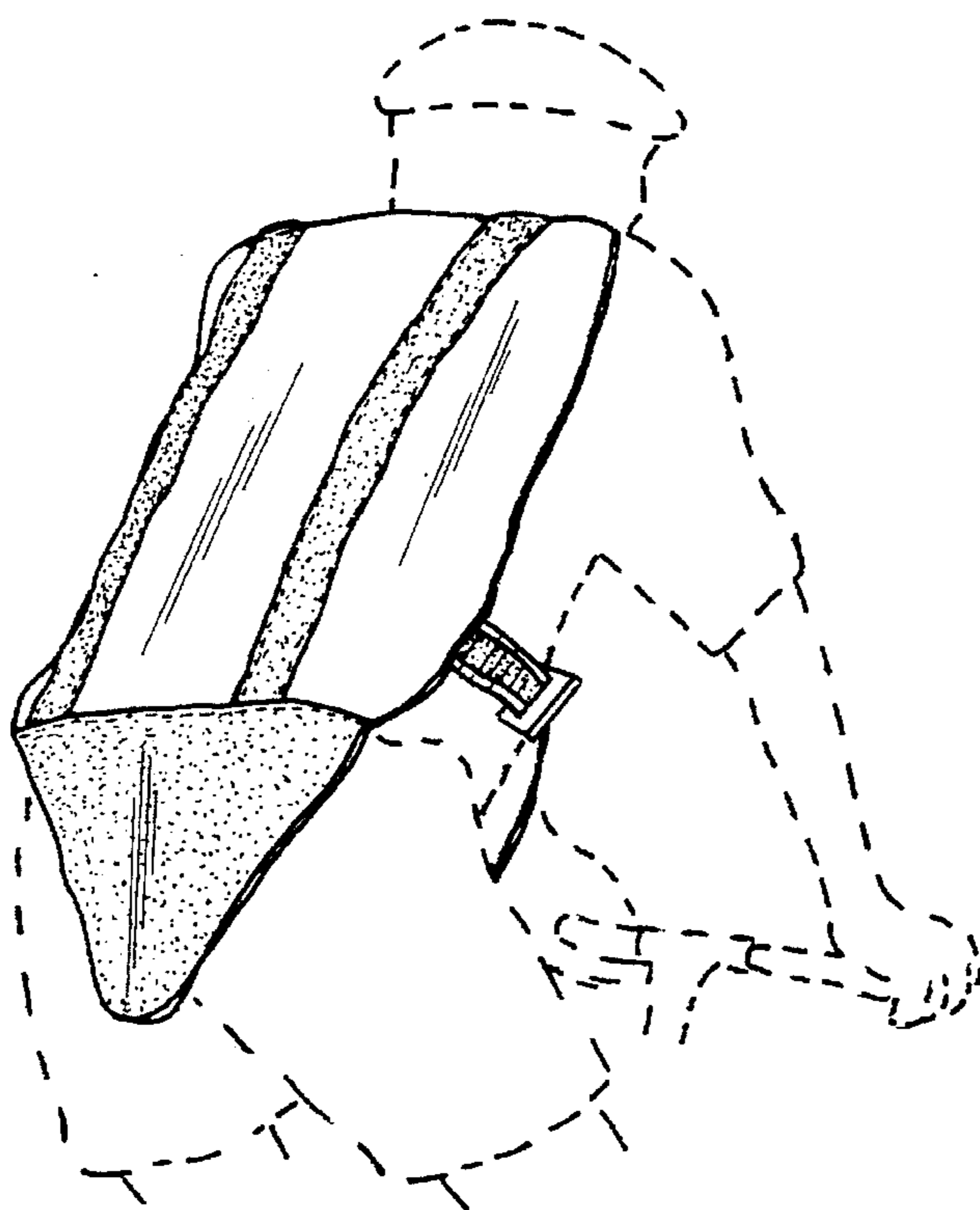

Fig. 2

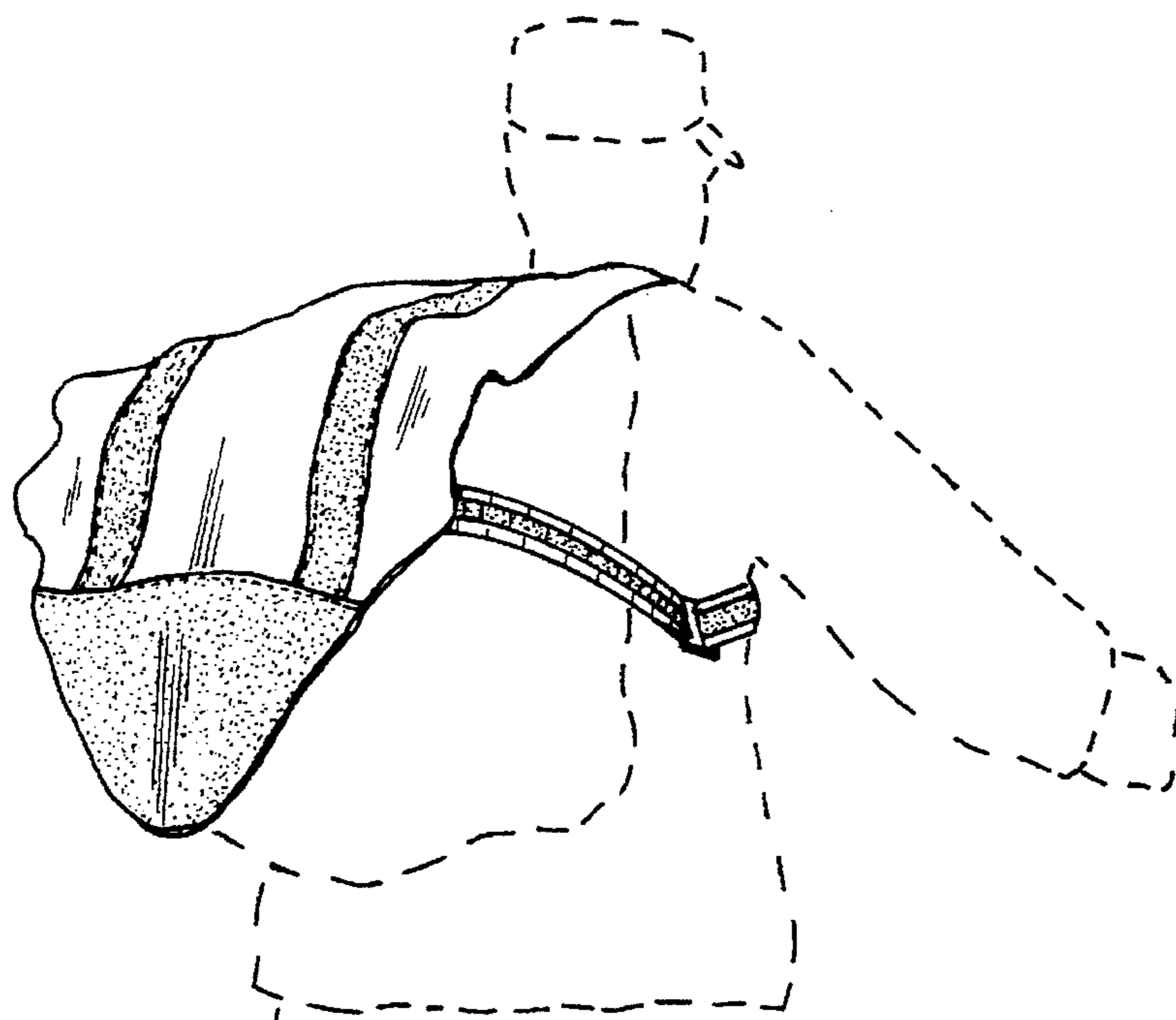

Fig. 3

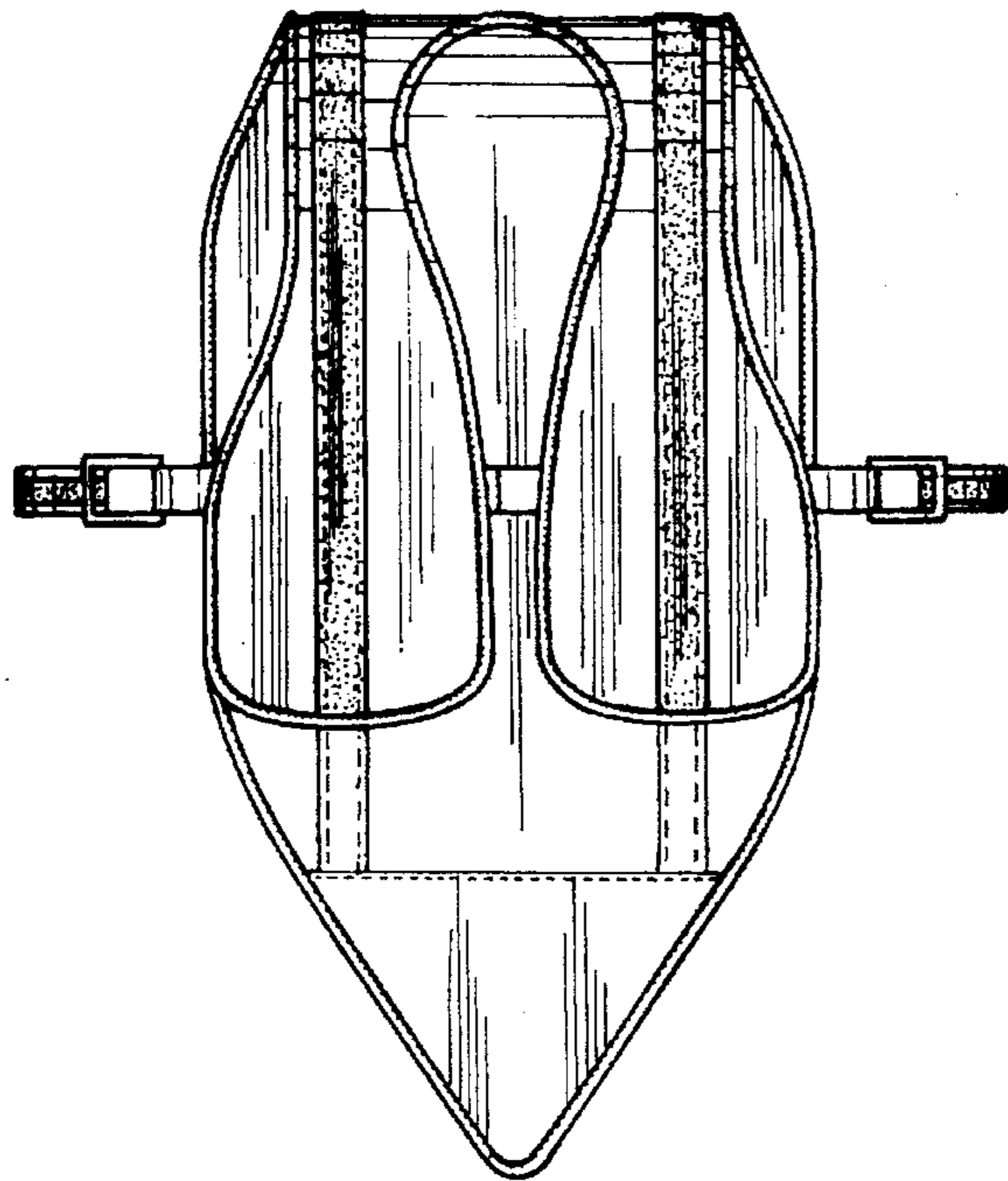

Fig. 4

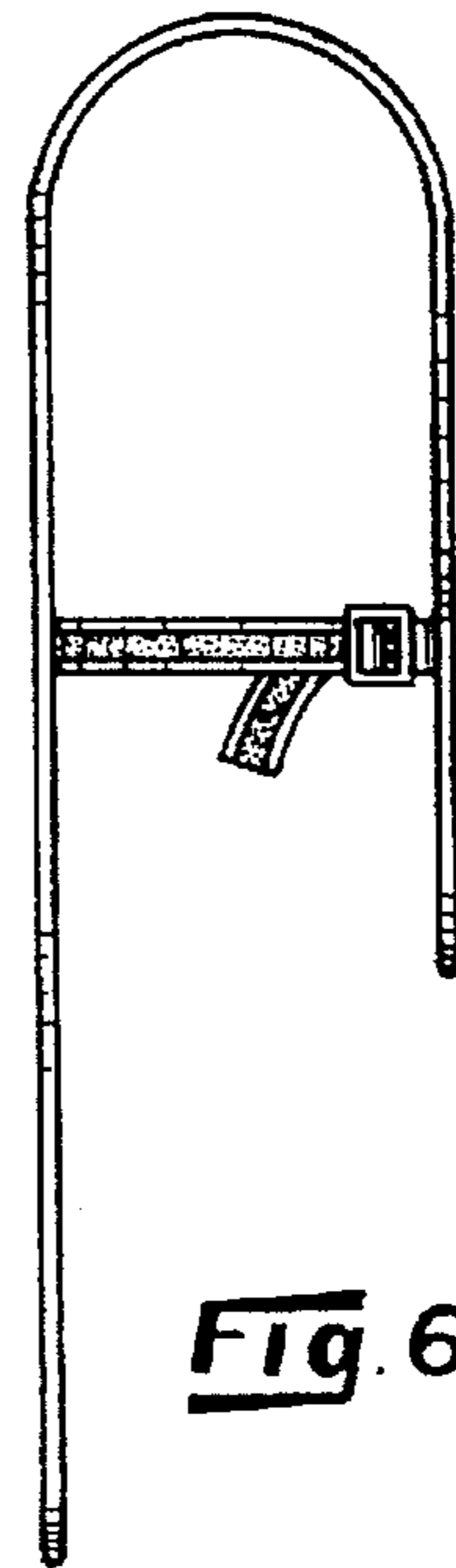

Fig. 6

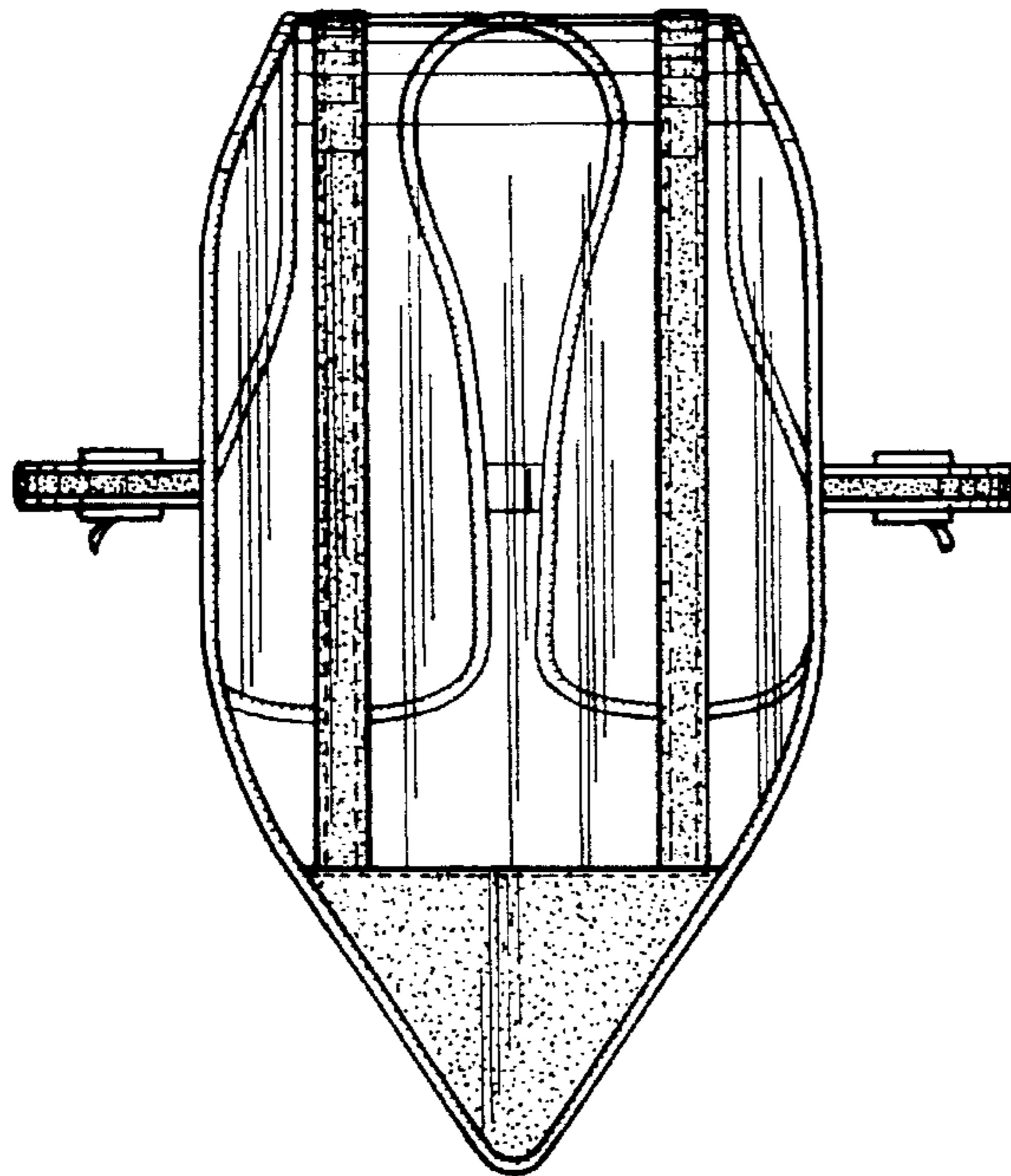

Fig. 5

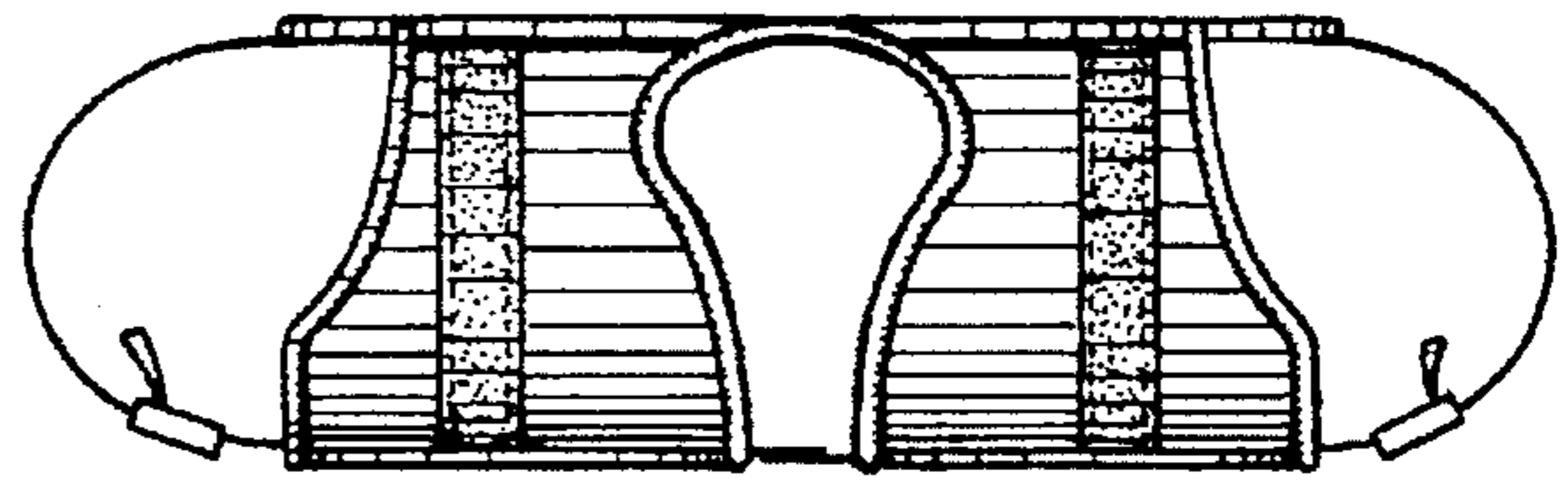

Fig. 7

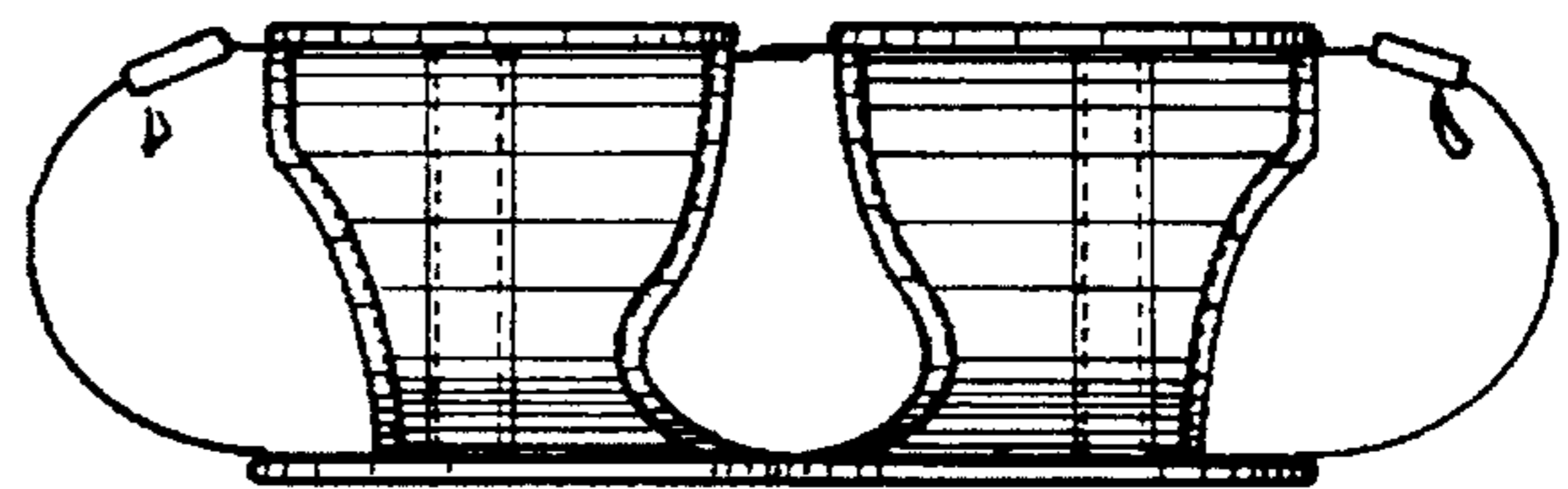

Fig. 8