



US00D382650S

# United States Patent [19]

[11] Patent Number: **Des. 382,650**

**Bauer**

[45] Date of Patent: **\*\*Aug. 19, 1997**

[54] CANOPY

[76] Inventor: **Daniel R. Bauer**, 498 Stage Line Rd., Hudson, Wis. 54016

[\*\*] Term: **14 Years**

[21] Appl. No.: **54,073**

[22] Filed: **May 6, 1996**

[51] LOC (6) Cl. .... **25-02**

[52] U.S. Cl. .... **D25/56**

[58] Field of Search ..... D25/56; D15/9.1; 115/87, 96, 99, 115

[56] **References Cited**

**U.S. PATENT DOCUMENTS**

D. 195,024	4/1963	McGee et al. ....	D25/56
D. 349,579	8/1994	Goldberg .....	D25/56
3,226,891	1/1966	Heirich .....	D25/56

*Primary Examiner*—Doris Clark  
*Attorney, Agent, or Firm*—Roger W. Jensen

[57] **CLAIM**

The ornamental design for a canopy, as shown and described.

**DESCRIPTION**

FIG. 1 is a left front isometric view of a first embodiment showing my new design;  
FIG. 2 is a front view of the canopy of FIG. 1;

FIG. 3 is a right side view;  
FIG. 4 is a left side view;  
FIG. 5 is a back view;  
FIG. 6 is a top view;  
FIG. 7 is a bottom view;  
FIG. 8 is a fragmentary bottom view of a second embodiment, the front, sides, back and top views being substantially identical to those views of the canopy shown in FIGS. 1-6;  
FIG. 9 is a fragmentary bottom view of a third embodiment, the front, sides, back, and top views being substantially identical to those views of the canopy shown in FIGS. 1-6;  
FIG. 10 is a fragmentary bottom view of a fourth embodiment, the front, sides, back, and top views being substantially identical to those views of the canopy shown in FIGS. 1-6;  
FIG. 11 is a fragmentary bottom view of a fourth embodiment, the front, sides, back, and top views being substantially identical to those views of the canopy shown in FIGS. 1-6;  
FIG. 12 is a fragmentary bottom view of a fourth embodiment, the front, sides, back, and top views being substantially identical to those views of the canopy shown in FIGS. 1-6;  
FIG. 13 is a fragmentary bottom view of a fourth embodiment, the front, sides, back, and top views being substantially identical to those views of the canopy shown in FIGS. 1-6; and,  
FIG. 14 is a fragmentary bottom view of a fifth embodiment, the front, sides, back, and top views being substantially identical to those views of the canopy shown in FIGS. 1-6.

**1 Claim, 3 Drawing Sheets**

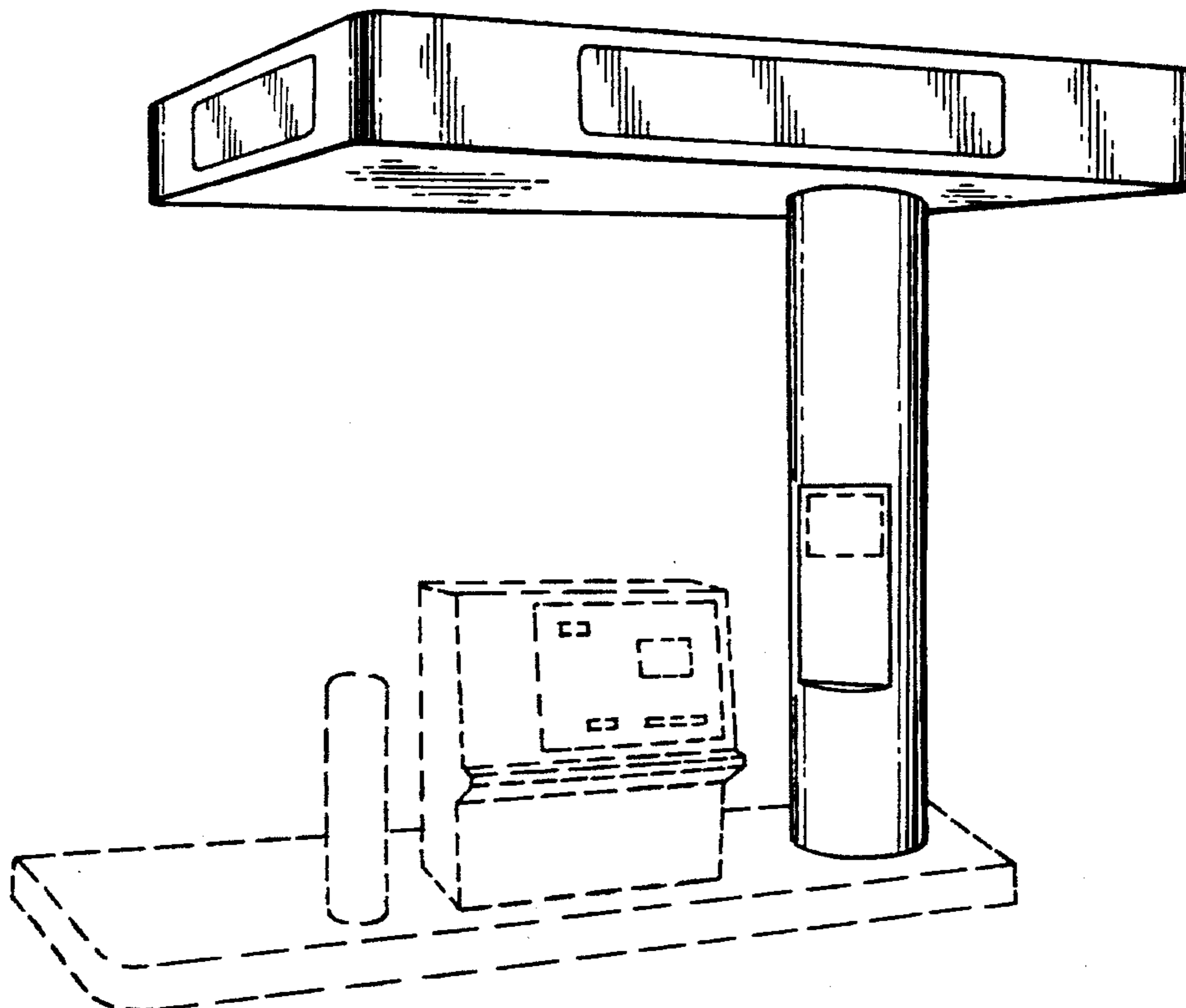

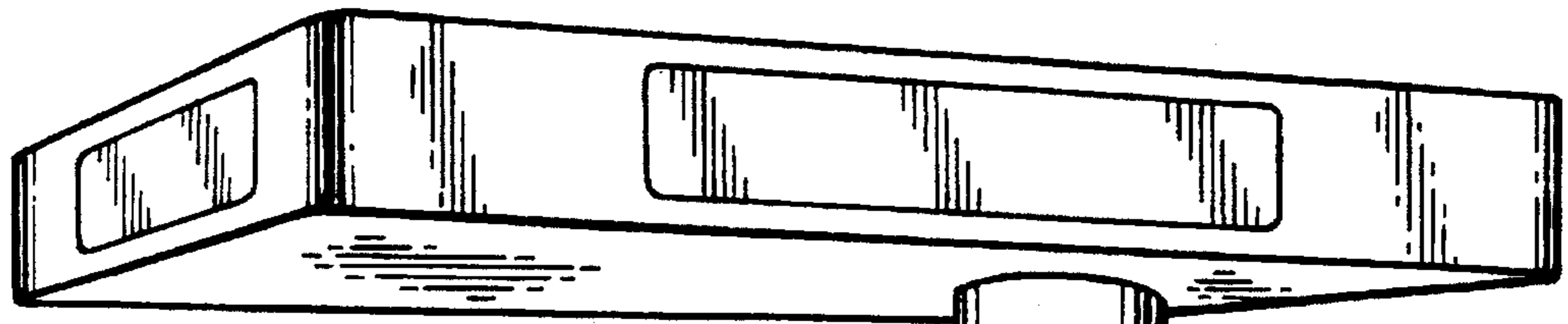

*FIG. 1*

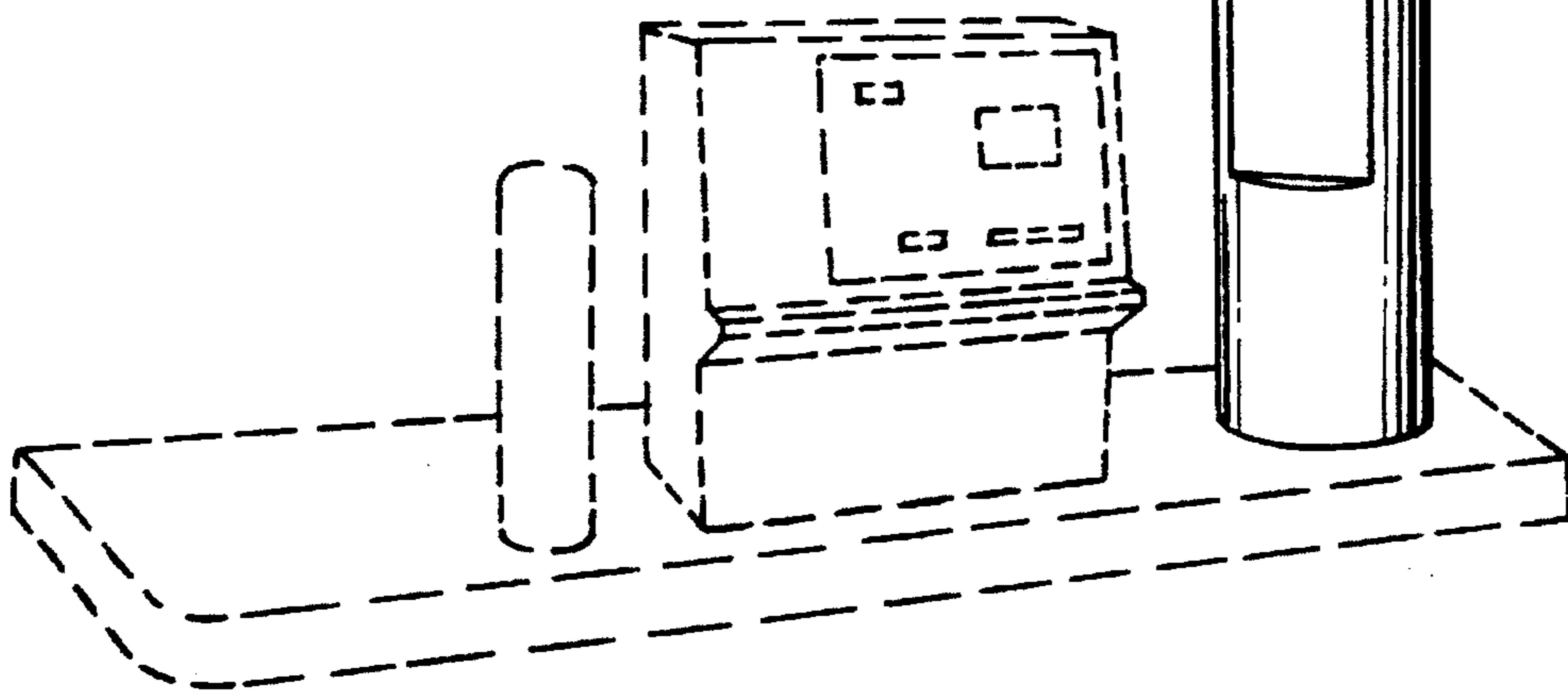

*FIG. 6*

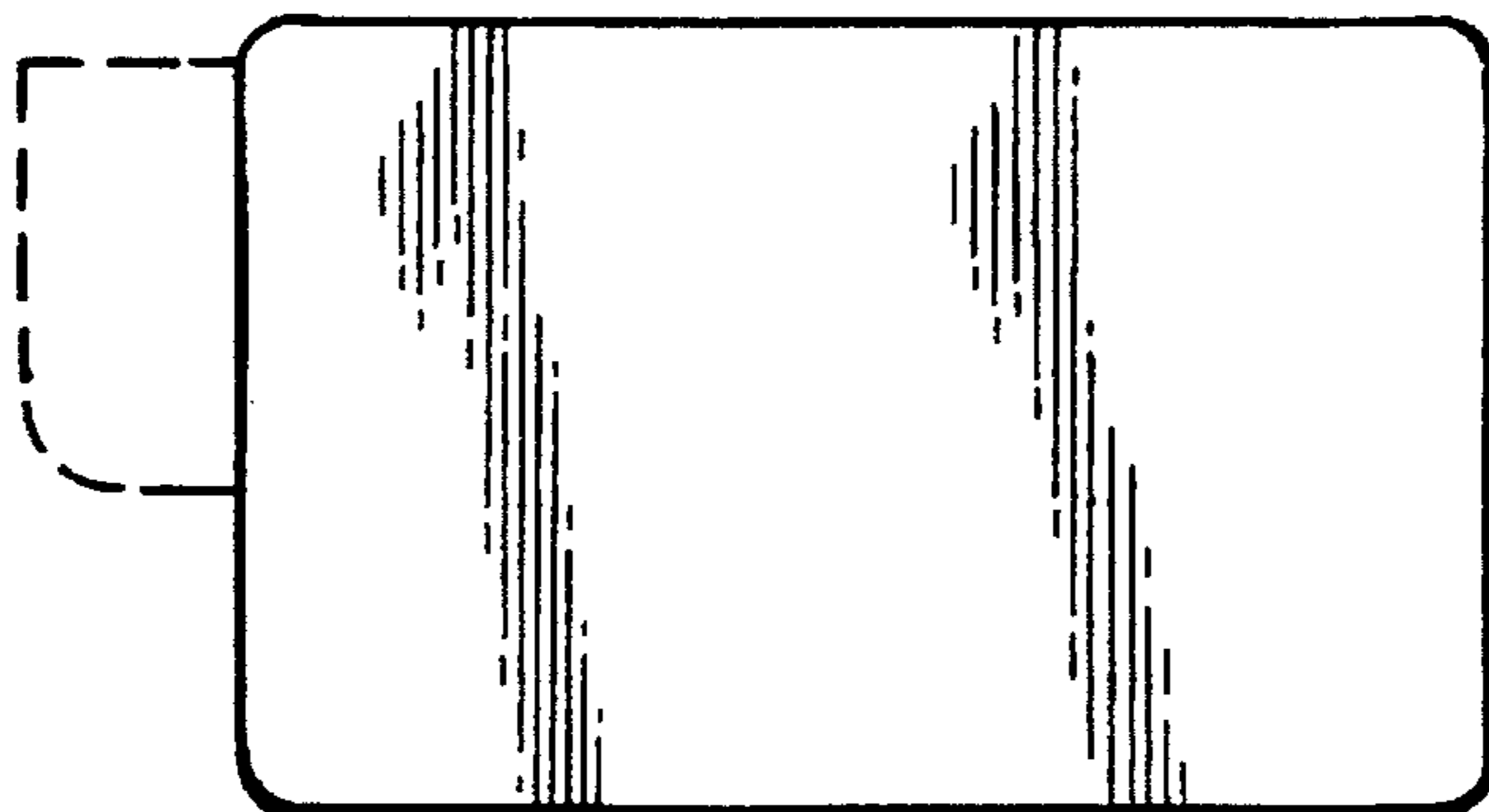

FIG. 2

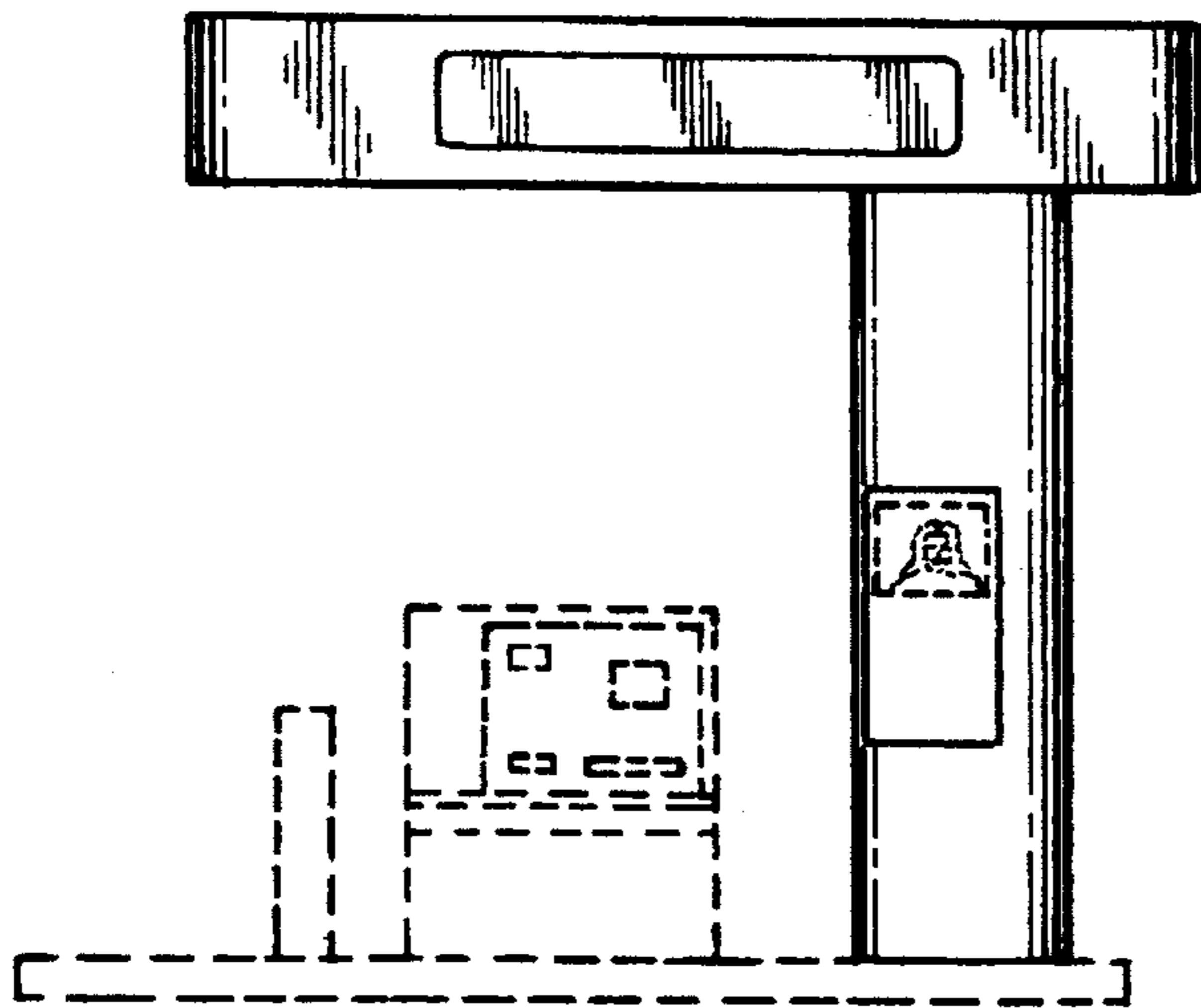

FIG. 3

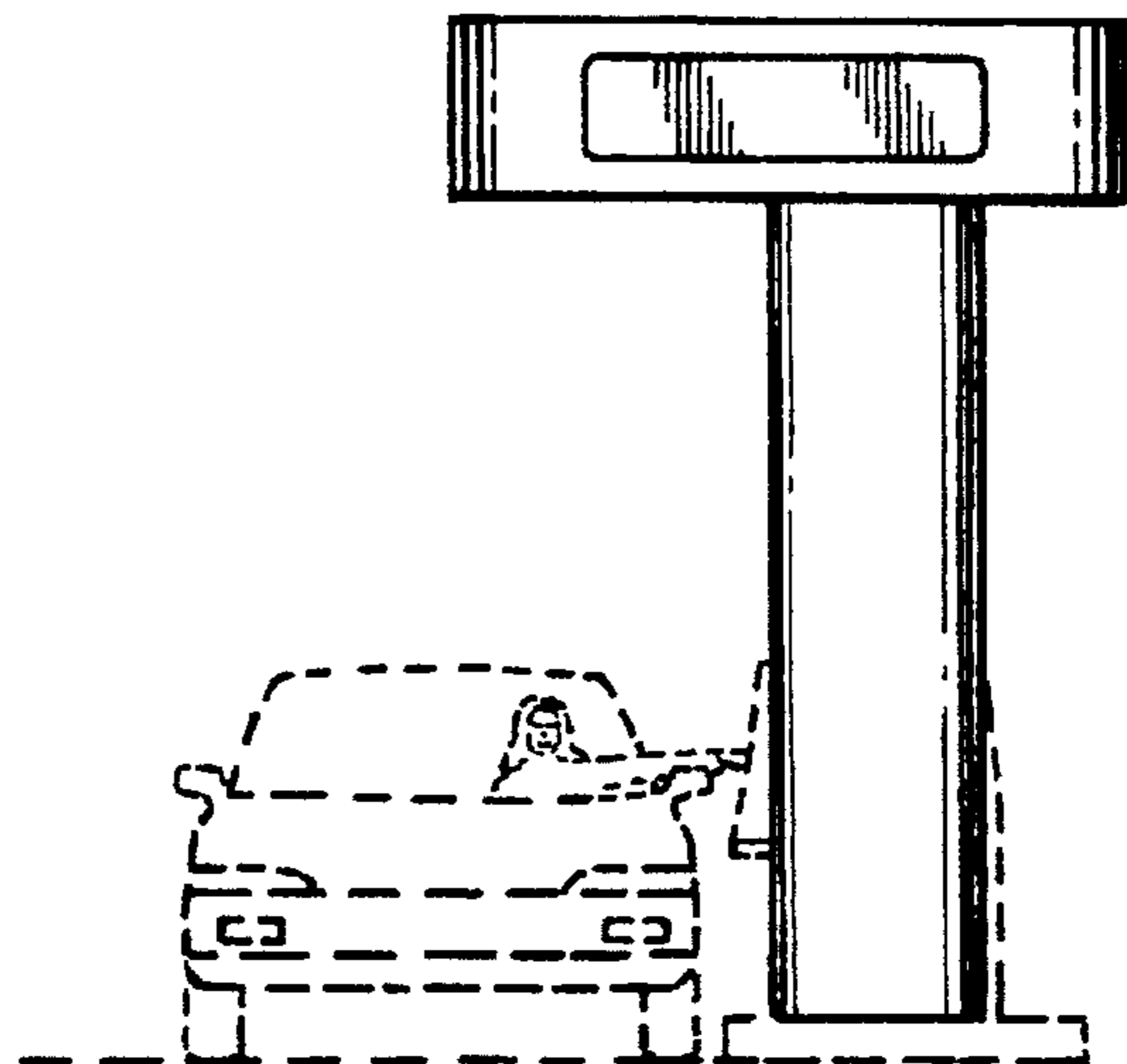

FIG. 4

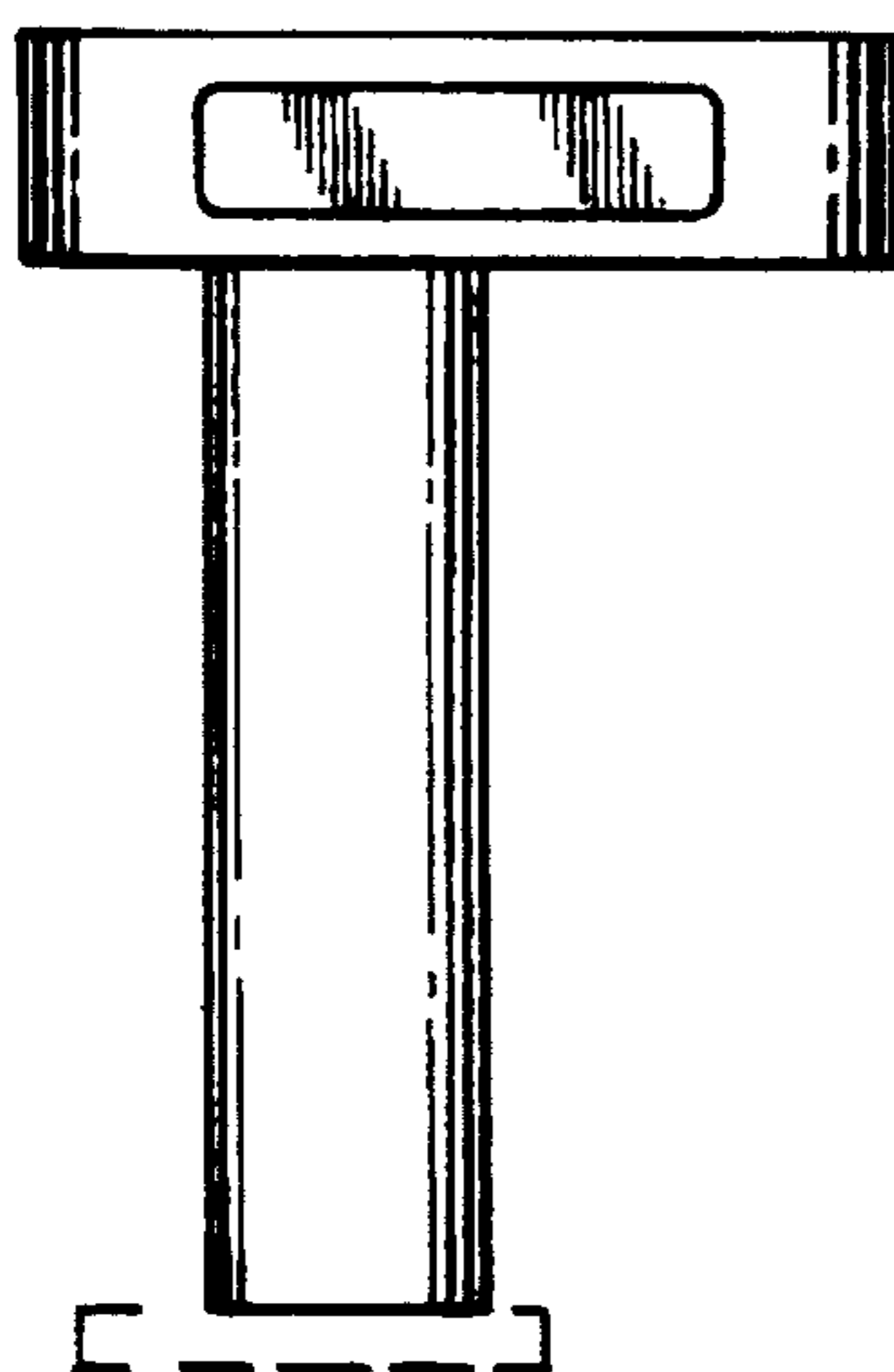

FIG. 5

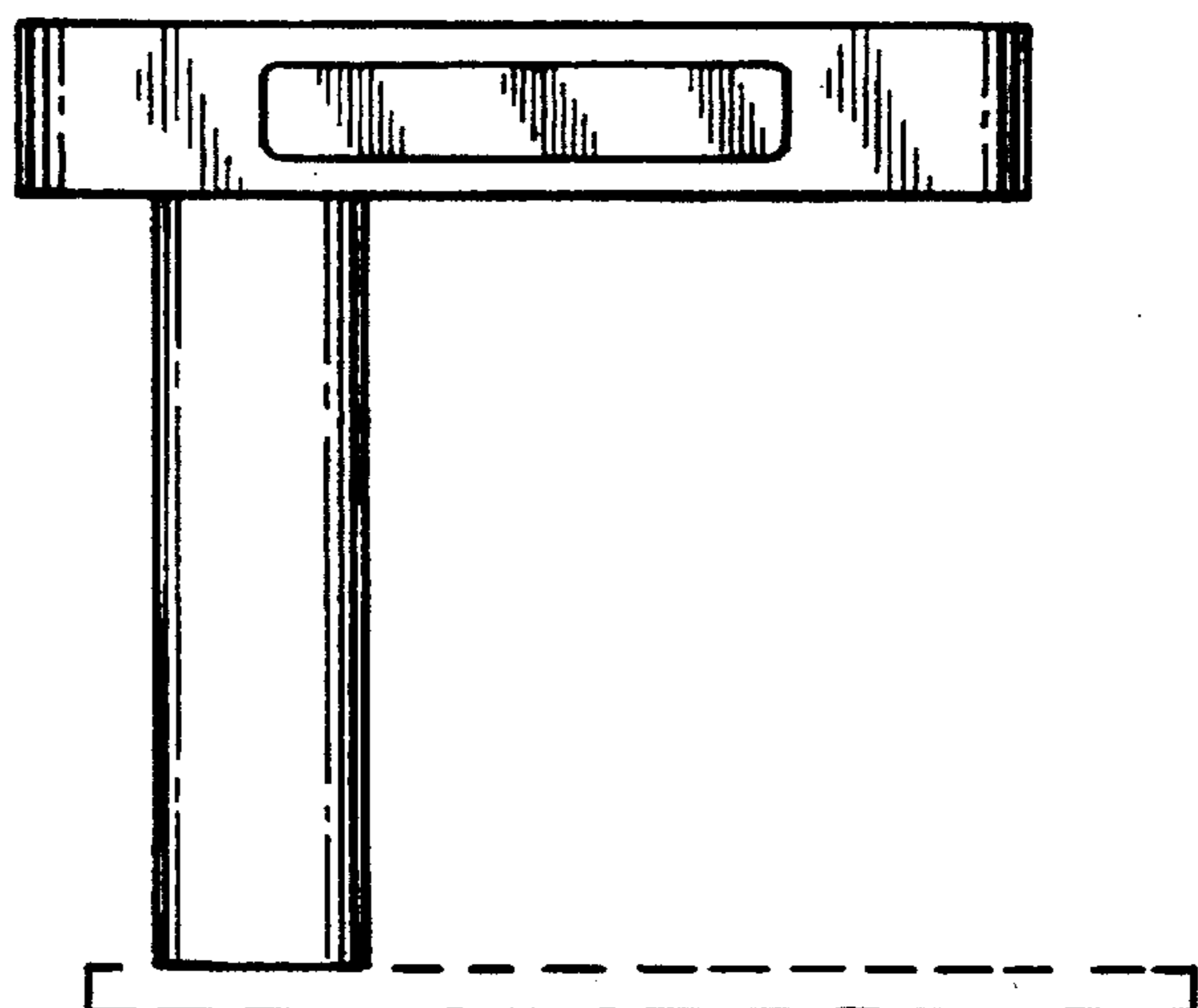

FIG. 7

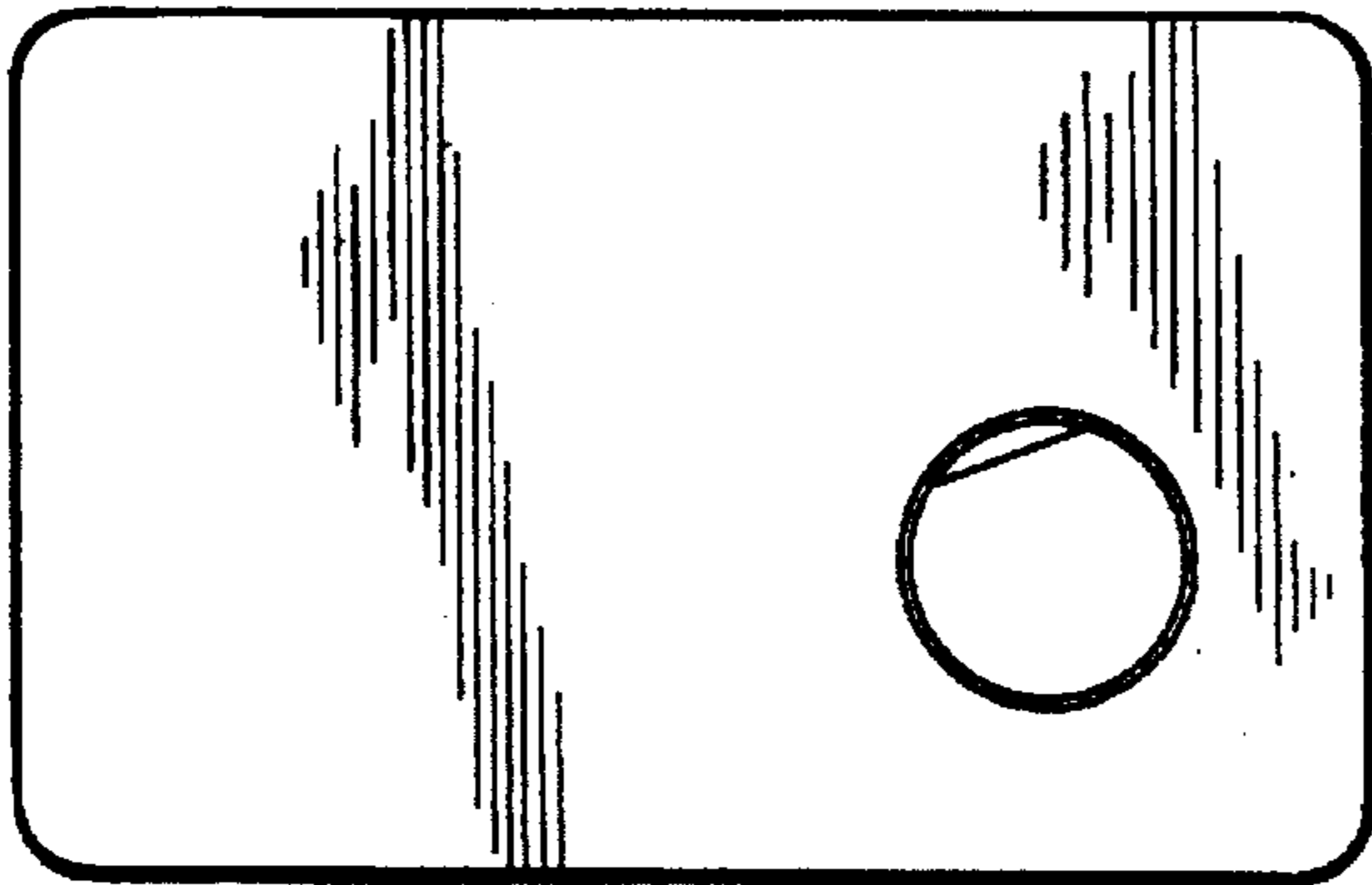

FIG. 8

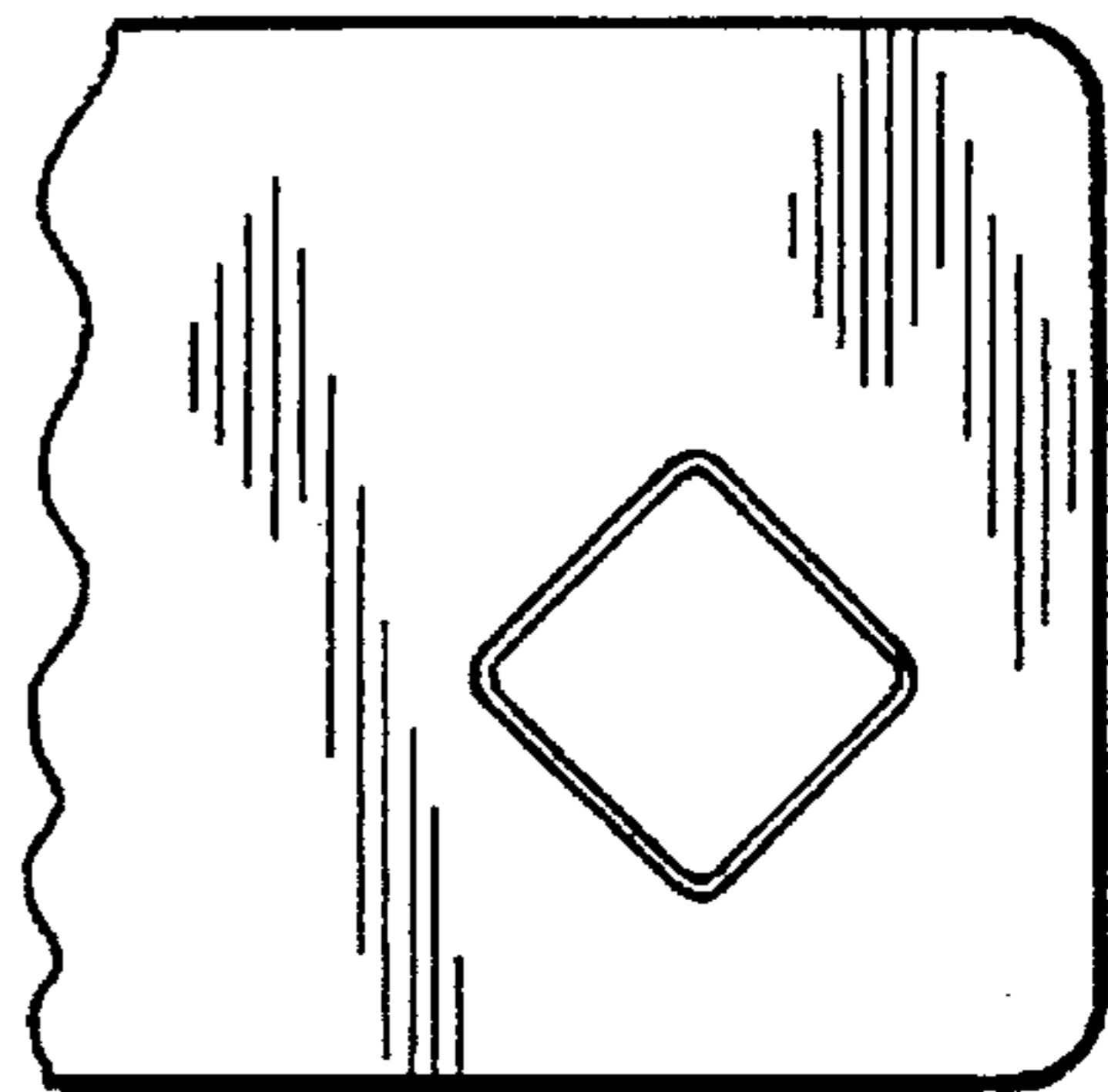

FIG. 9

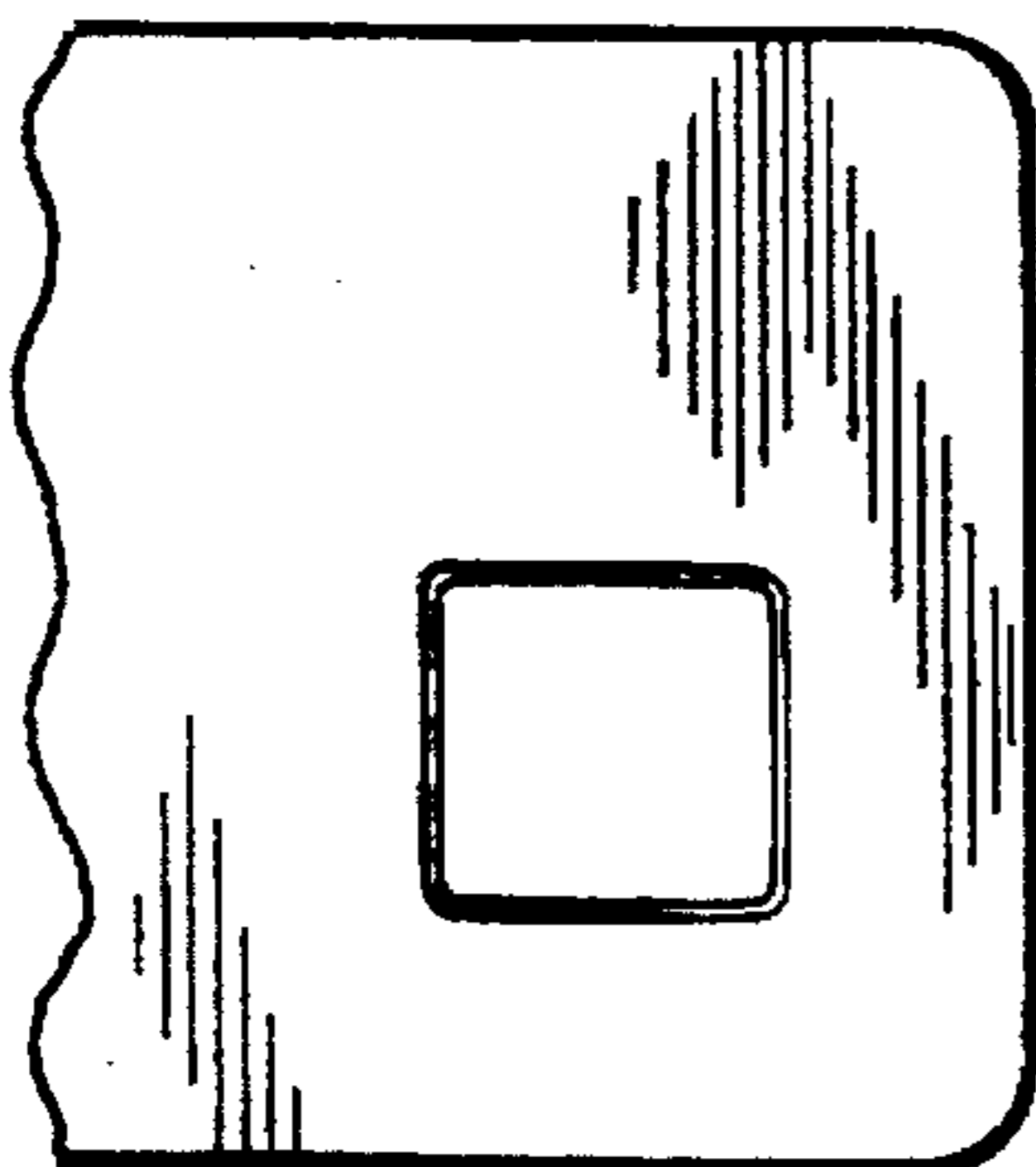

FIG. 10

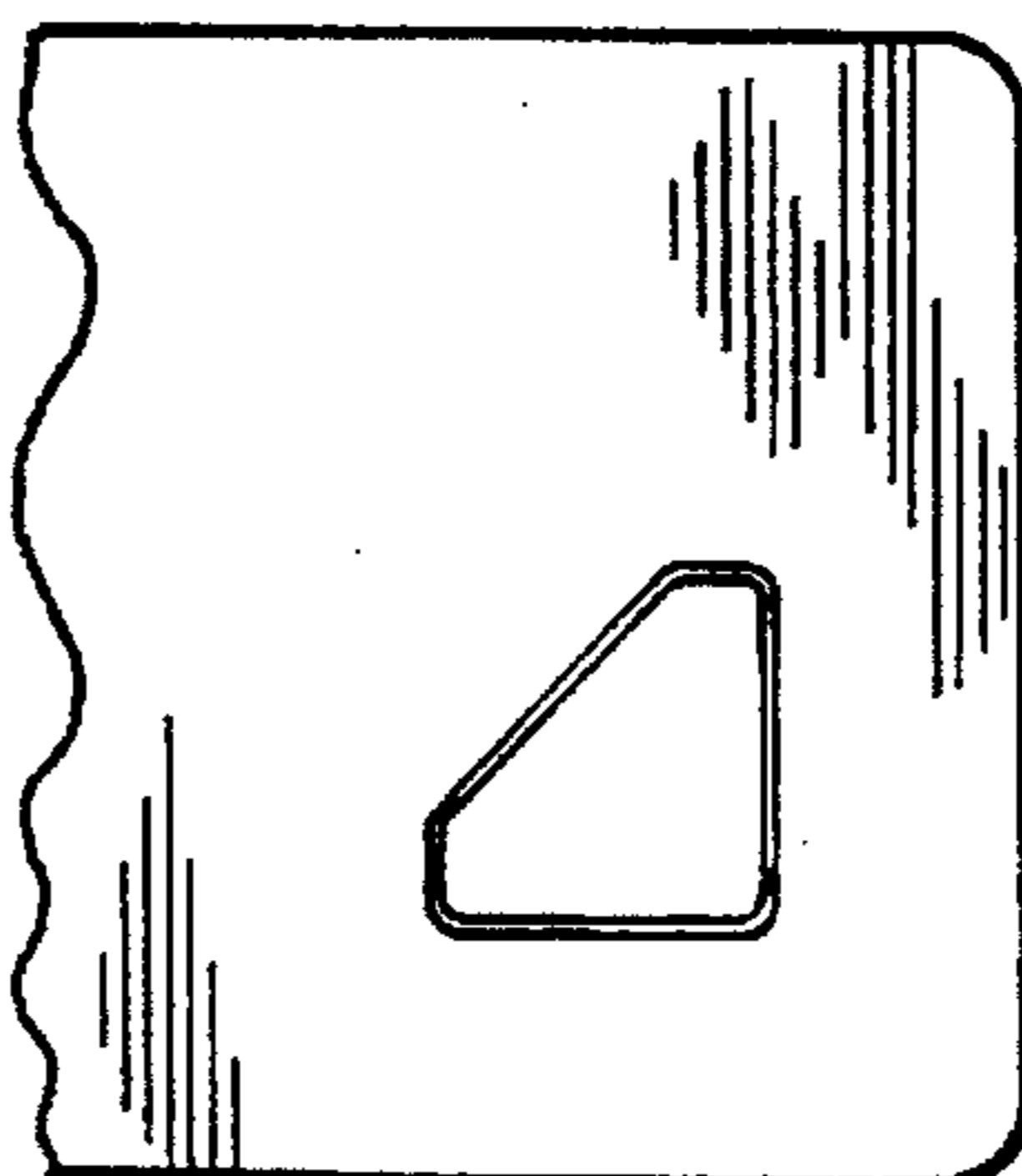

FIG. 11

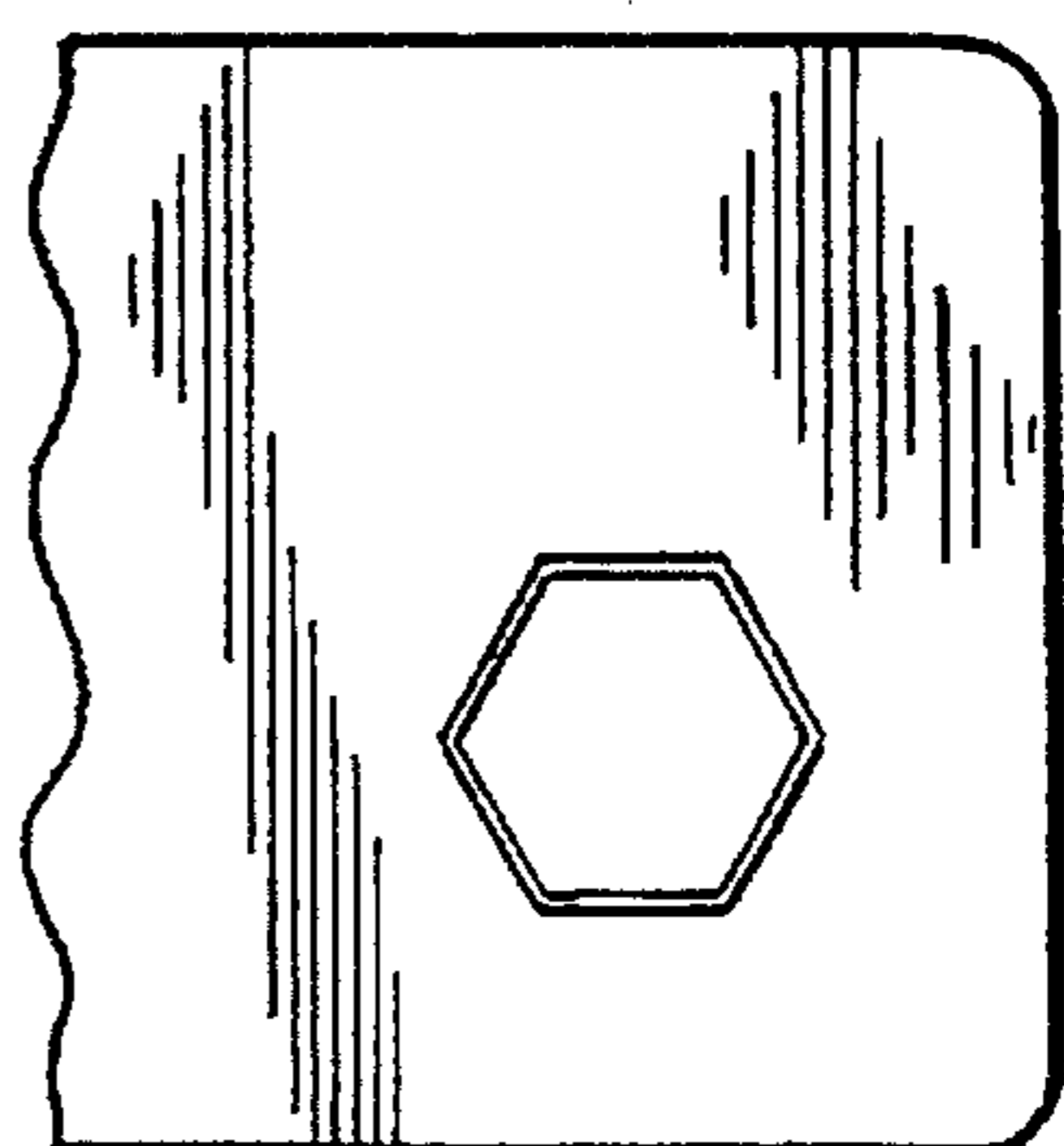

FIG. 12

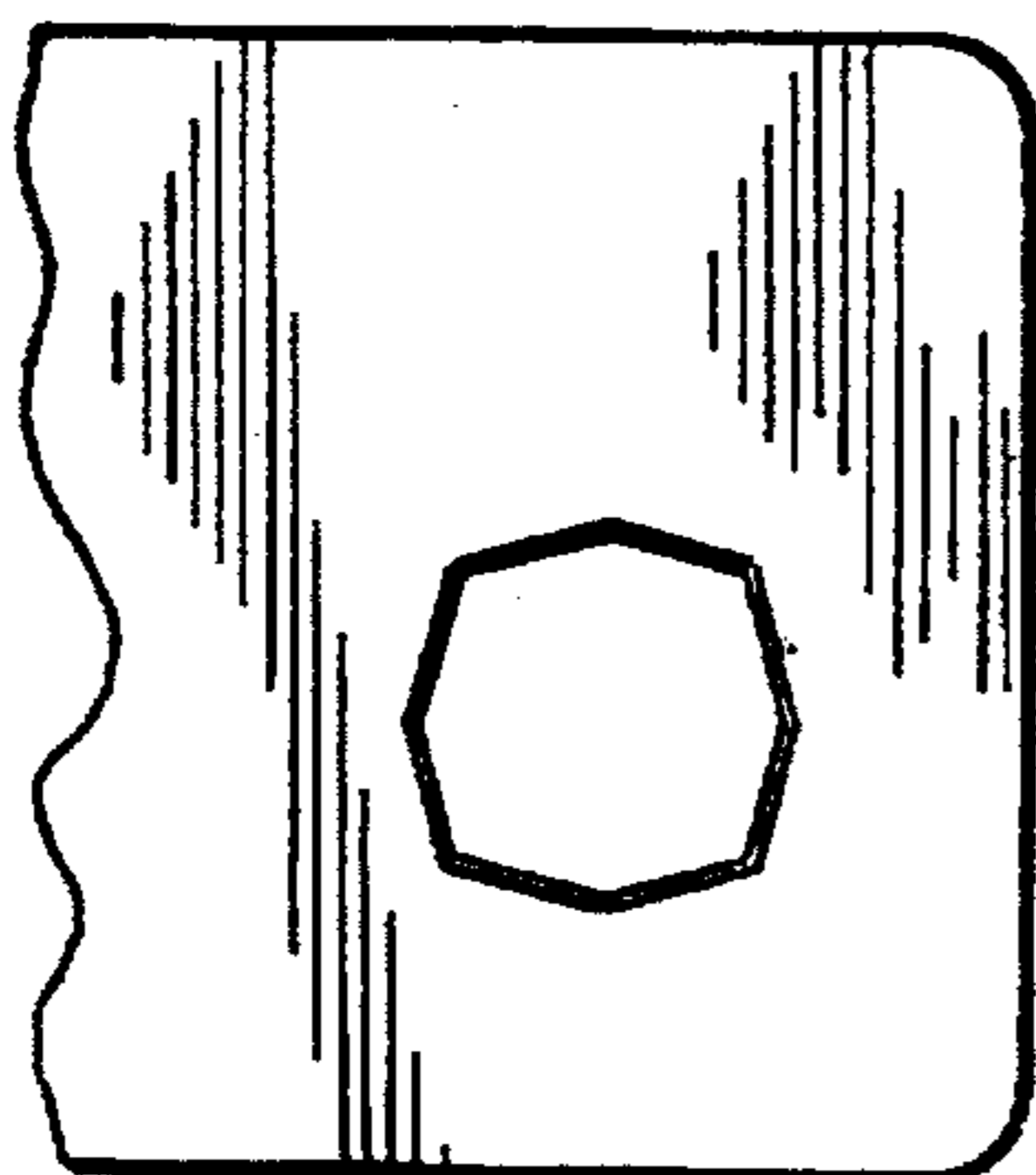

FIG. 13

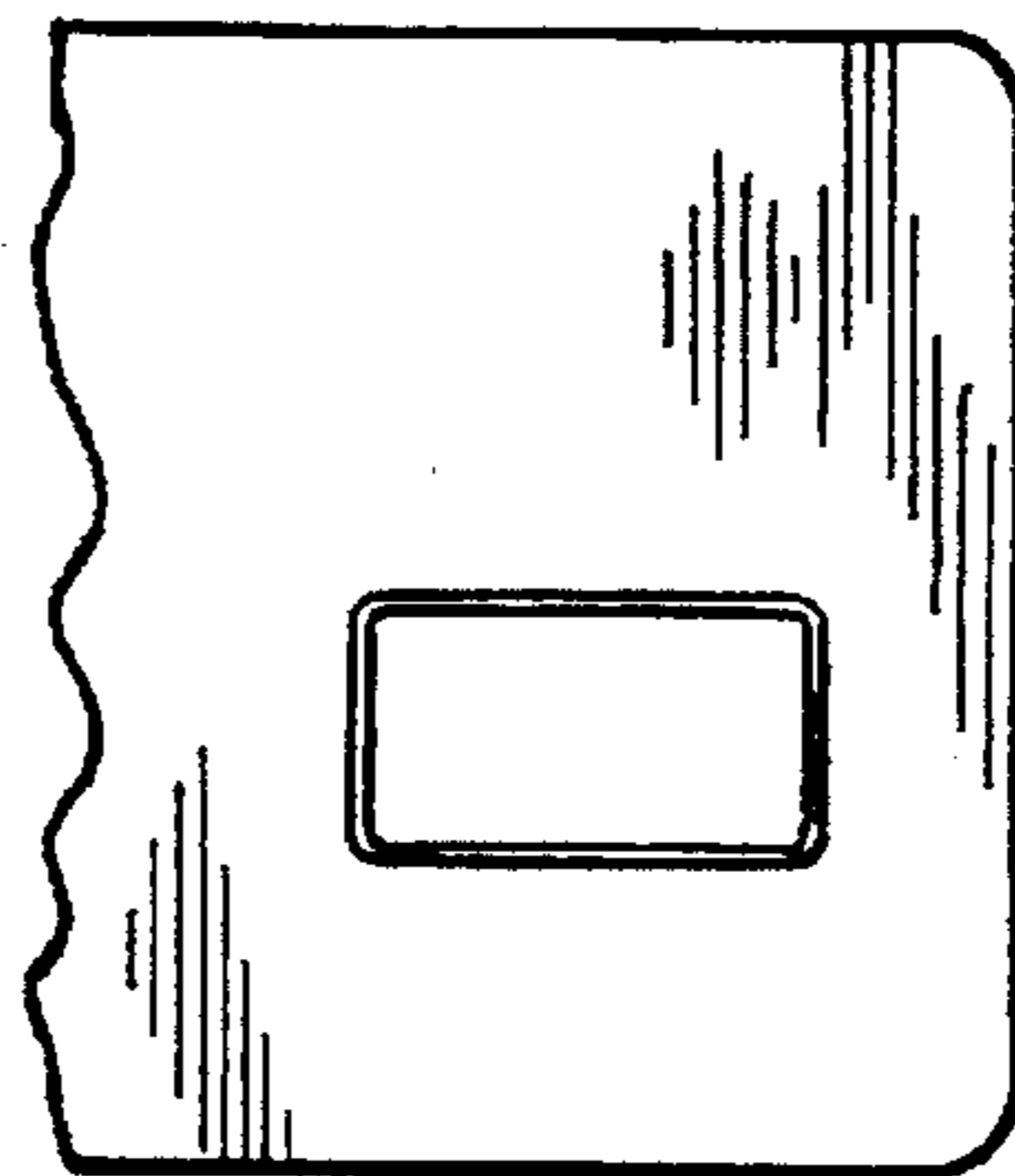

FIG. 14

