



US00D382582S

United States Patent [19]

Igarashi et al.

[11] Patent Number: Des. 382,582

[45] Date of Patent: **Aug. 19, 1997

[54] LASER BEAM PRINTER

[75] Inventors: **Masaaki Igarashi**, Machida; **Naoki Tashiro**, Kawasaki; **Akira Katsuno**, Machida; **Hiroyuki Tokuda**, Yokohama, all of Japan

[73] Assignee: **Canon Kabushiki Kaisha**, Tokyo, Japan

[**] Term: **14 Years**

[21] Appl. No.: **48,406**

[22] Filed: **Dec. 28, 1995**

[30] **Foreign Application Priority Data**

Jun. 28, 1995 [JP] Japan 7-18663

[51] LOC (6) Cl. **18-02**

[52] U.S. Cl. **D18/55**

[58] Field of Search D18/50, 54-55, D18/36-39; D14/118; 400/691-694, 690.1, 690.4, 613, 613.1-613.4

[56] **References Cited**

U.S. PATENT DOCUMENTS

D. 318,288	7/1991	Tashiro	D18/54
D. 318,483	7/1991	Tashiro	D18/55
D. 319,655	9/1991	Tokuda et al.	D18/54
D. 319,656	9/1991	Tashiro et al.	D18/54
D. 320,406	10/1991	Tokuda	D18/54
D. 321,002	10/1991	Tashiro et al.	D18/54
D. 322,091	12/1991	Tokuda	D18/54
D. 322,274	12/1991	Tokuda et al.	D18/54
D. 325,744	4/1992	Tokuda	D18/55
D. 326,109	5/1992	Tokuda	D18/55
D. 326,110	5/1992	Tashiro et al.	D18/55

D. 337,607	7/1993	Ito et al.	D18/54
D. 338,229	8/1993	Tashiro et al.	D18/55
D. 343,194	1/1994	Tashiro et al.	D18/55
D. 343,858	2/1994	Tashiro et al.	D18/55
D. 359,506	6/1995	Lee	D18/55
D. 363,713	10/1995	Kanari et al.	D14/118
D. 368,927	4/1996	Kim	D18/55
D. 371,158	6/1996	Yoshida	D18/50

OTHER PUBLICATIONS

Hewlett Packard brochure; Mar. 1993; Cover Photograph; Fax Machine.

Tektronix Phaser™ 200 Color Printer brochure; Feb. 1993. Dell Catalog; p. 16; Texas Instruments Micro-laser Plus Printer.

Sanyo Electric Co. brochure; Color PostScript™ Print-out System.

Primary Examiner—Cathy Anne MacCormac

Attorney, Agent, or Firm—Fitzpatrick, Cella, Harper & Scinto

[57] **CLAIM**

The ornamental design for a laser beam printer, as shown and described.

DESCRIPTION

FIG. 1 is a front view of a laser beam printer showing our new design;

FIG. 2 is a rear view thereof;

FIG. 3 is a top plan view thereof;

FIG. 4 is a bottom plan view thereof;

FIG. 5 is a left side view thereof;

FIG. 6 is a right side view thereof; and,

FIG. 7 is a perspective view thereof.

1 Claim, 5 Drawing Sheets

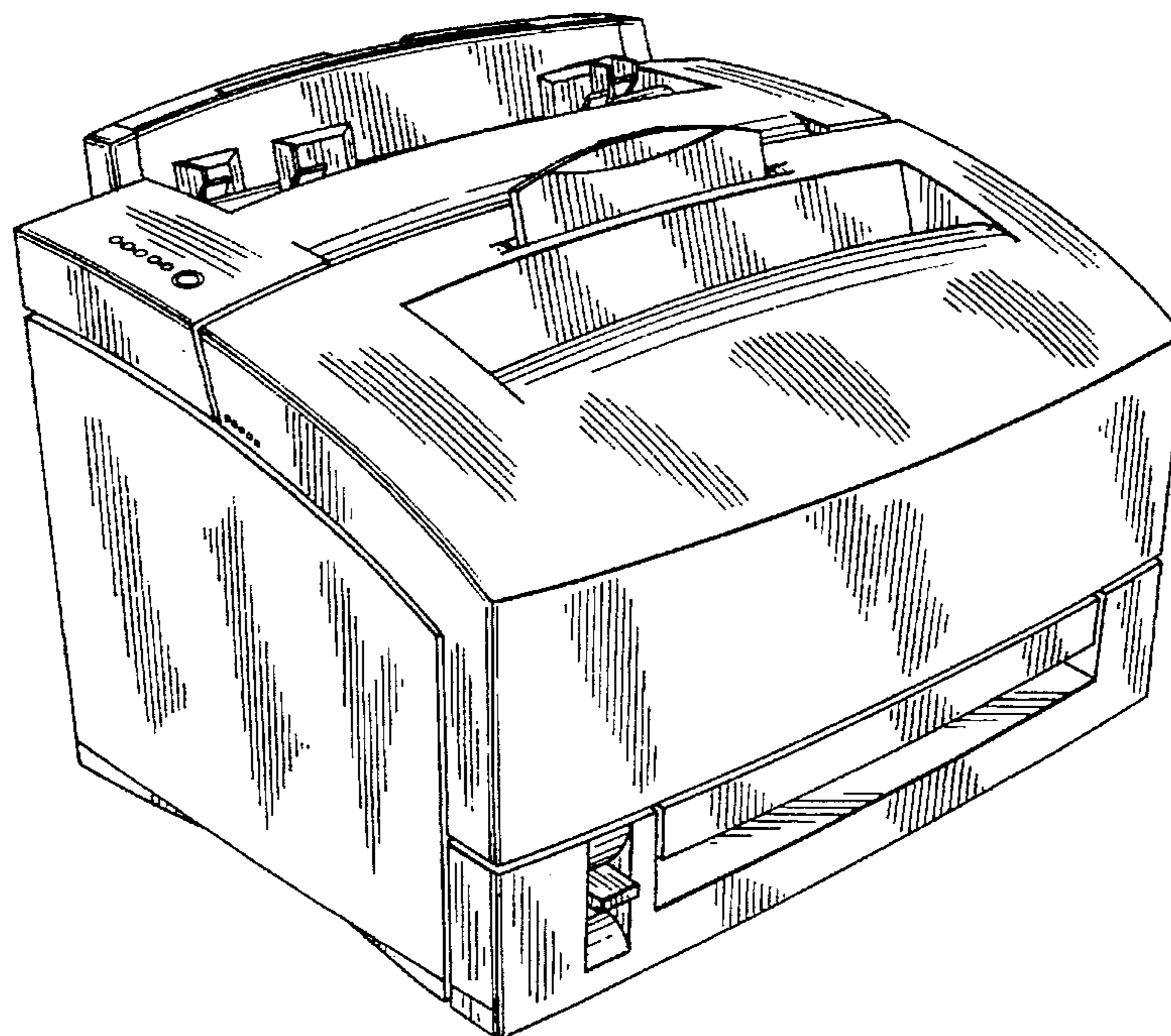

FIG. 1

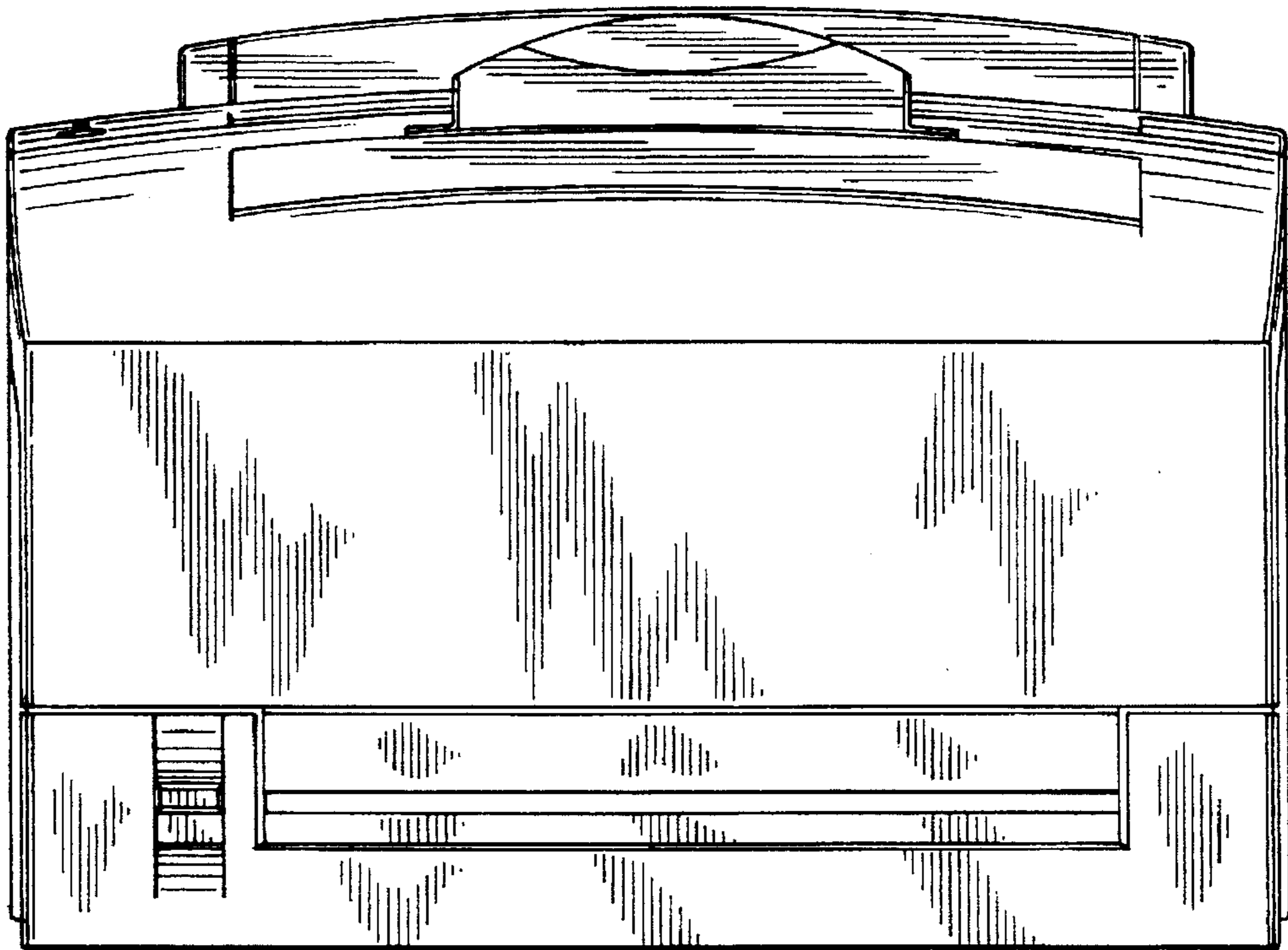

FIG. 2

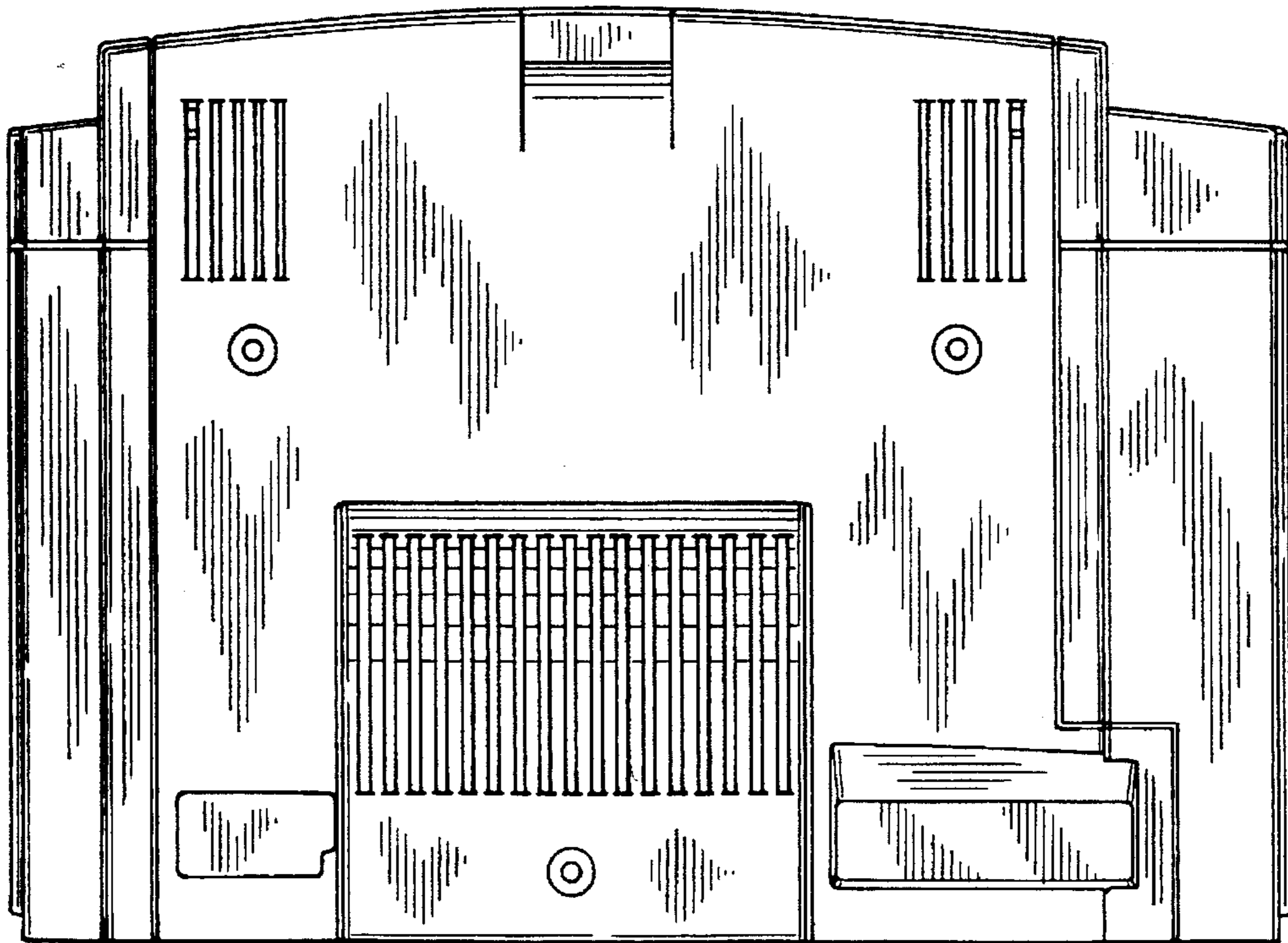

FIG. 3

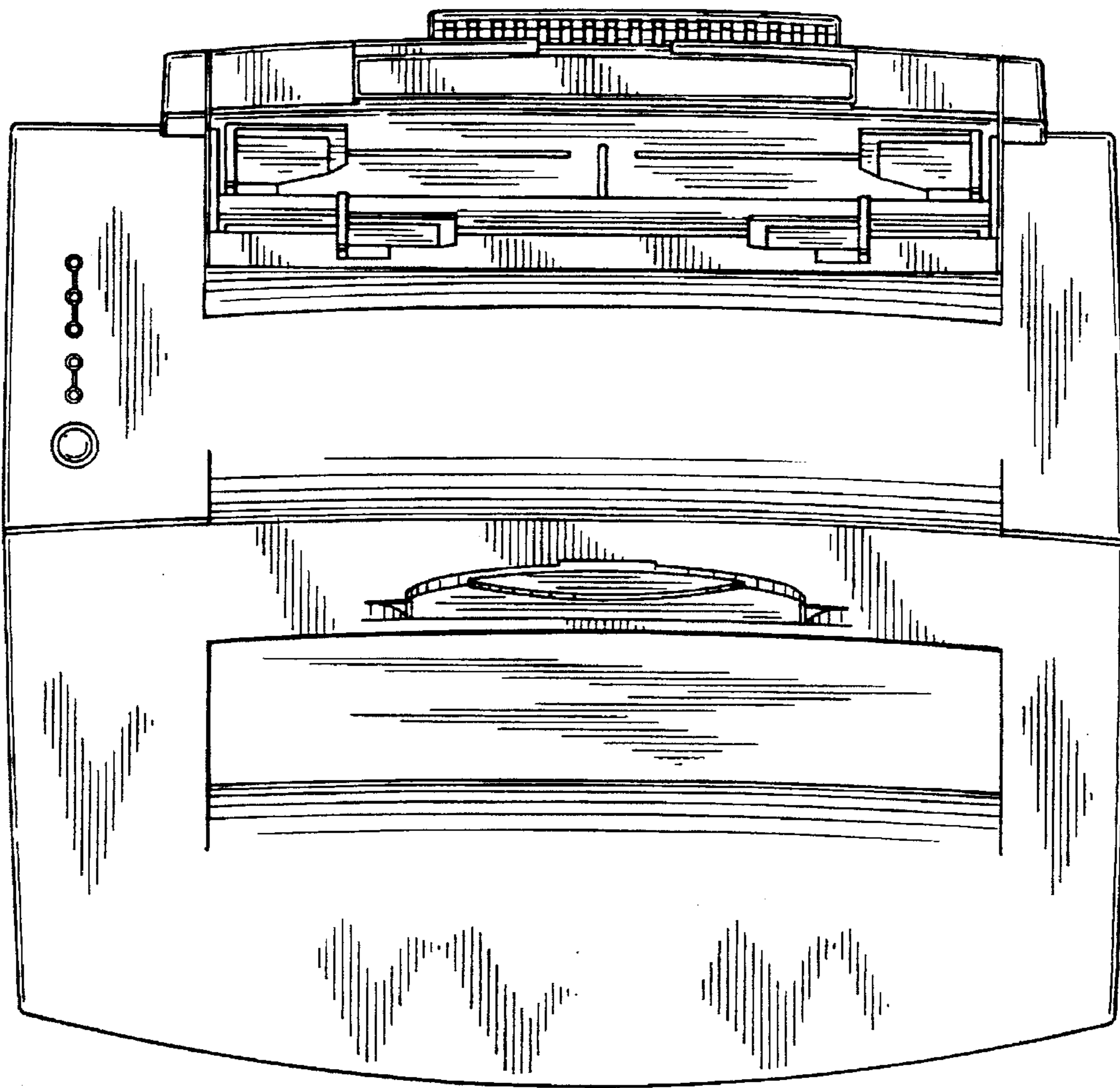

FIG. 4

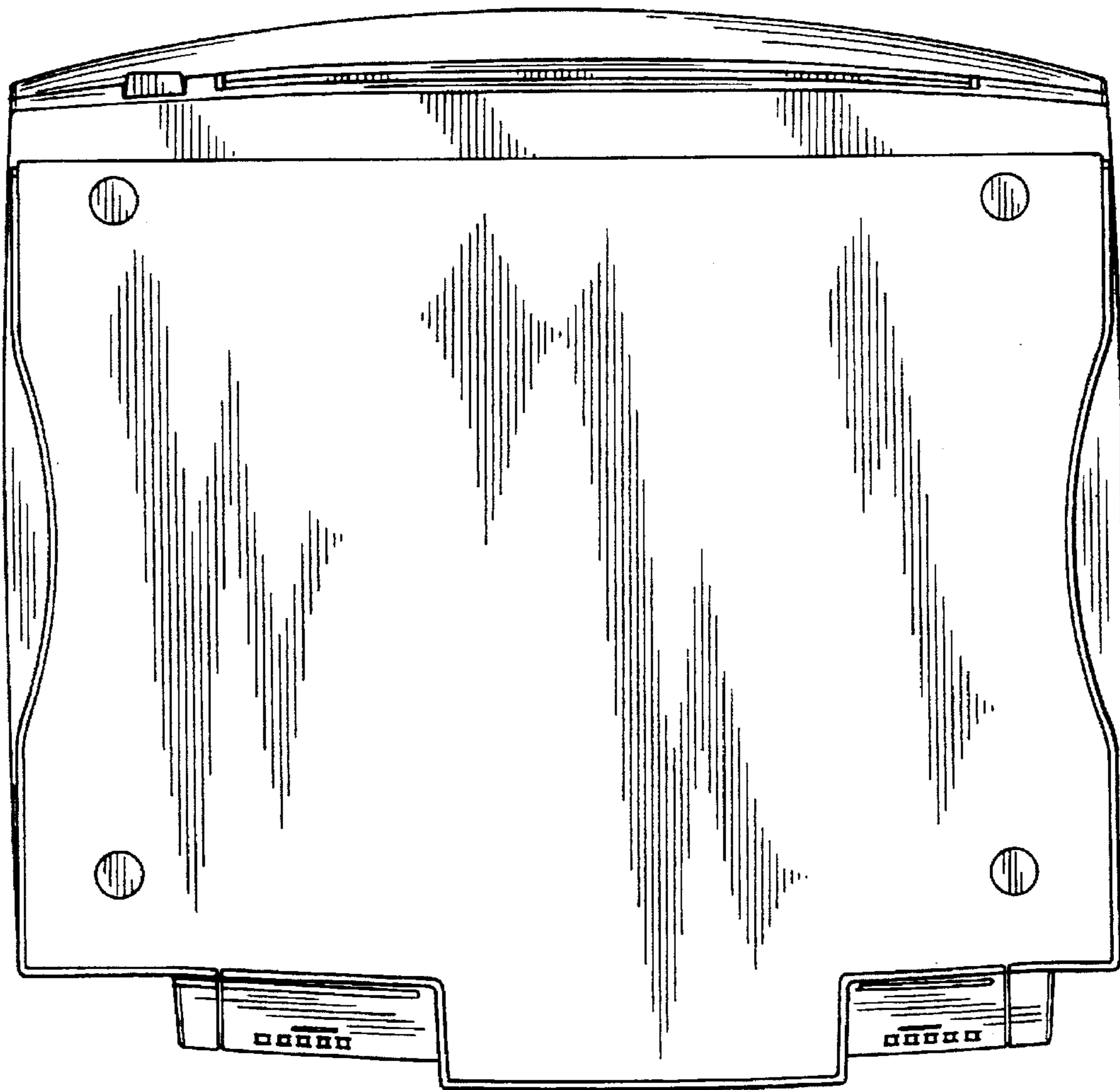

FIG. 5

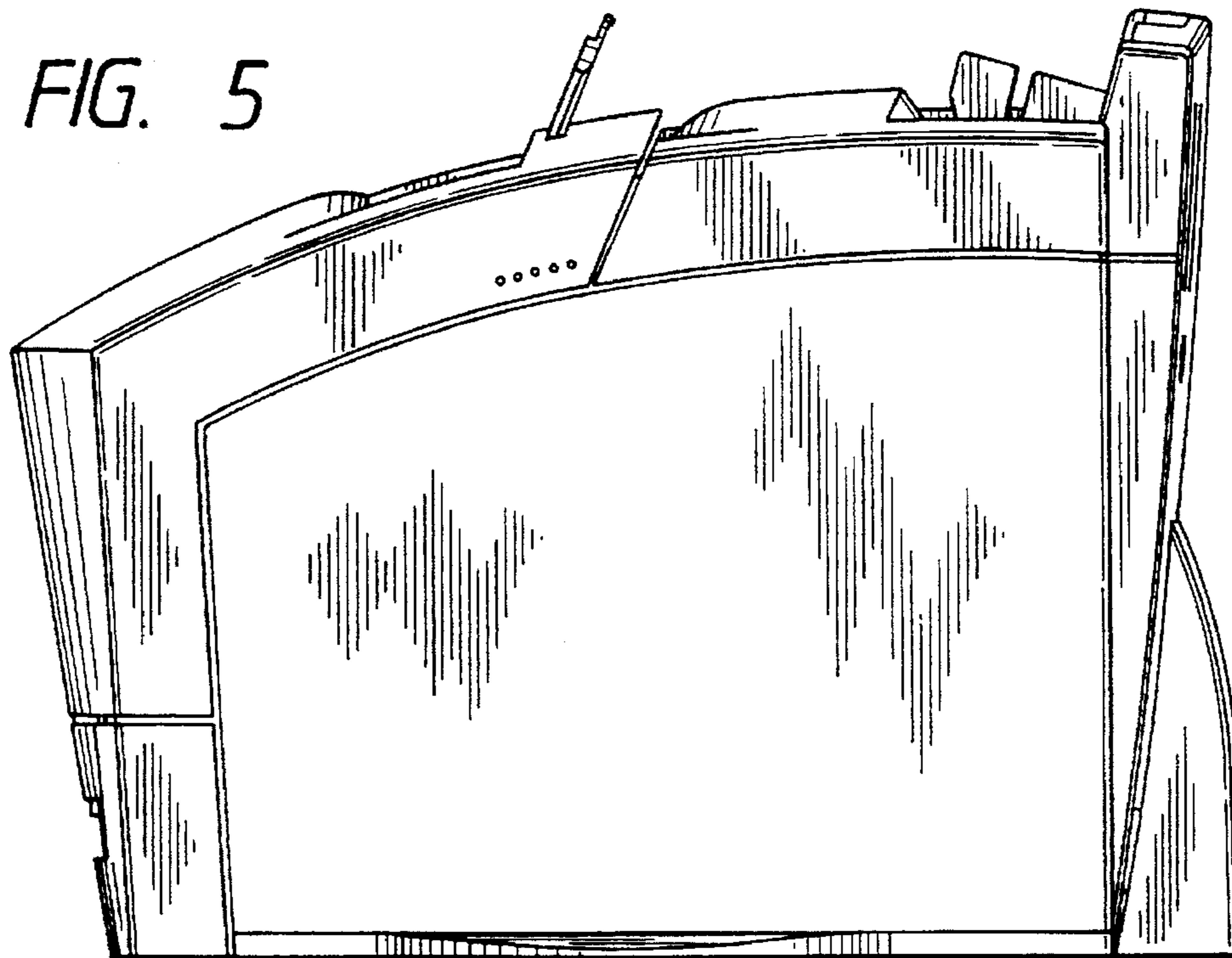

FIG. 6

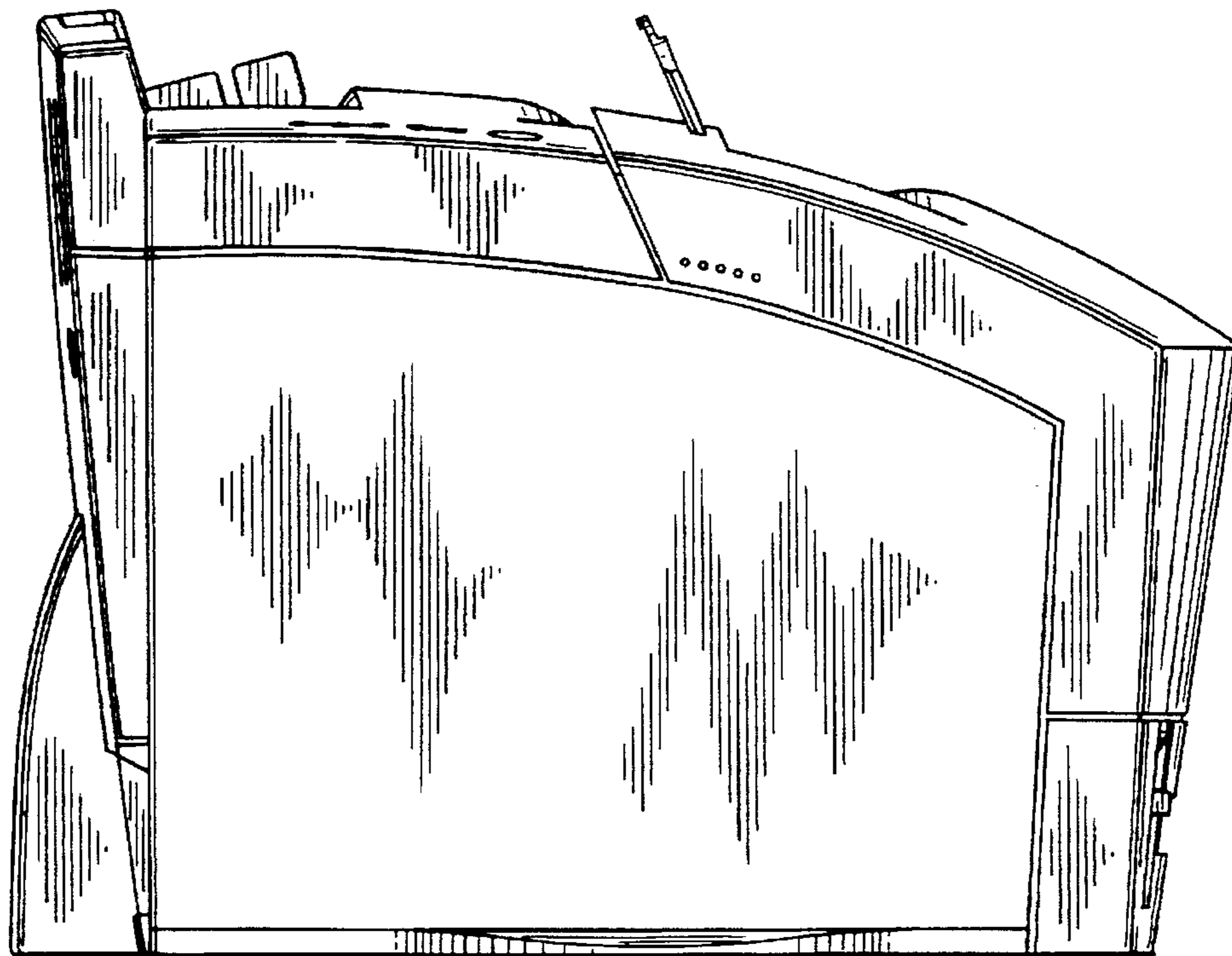

FIG. 7

